

ORANGE COUNTY CORRECTIONS HORIZON BUILDING SECURITY SCREEN REPLACEMENT

ISSUED FOR PERMIT AND CONSTRUCTION

September 29, 2015

Orange County Government

Capital Projects Division

400 East South Street
Orlando, FL 32801

BOARD OF COUNTY COMMISSIONERS

MAYOR - TERESA JACOBS

DISTRICT 1 COMMISSIONER - SCOTT BOYD

DISTRICT 2 COMMISSIONER - BRYAN NELSON

DISTRICT 3 COMMISSIONER - PETE CLARKE

DISTRICT 4 COMMISSIONER - JENNIFER THOMPSON

DISTRICT 5 COMMISSIONER - TED EDWARDS

DISTRICT 6 COMMISSIONER - VICTORIA P. SIPLIN

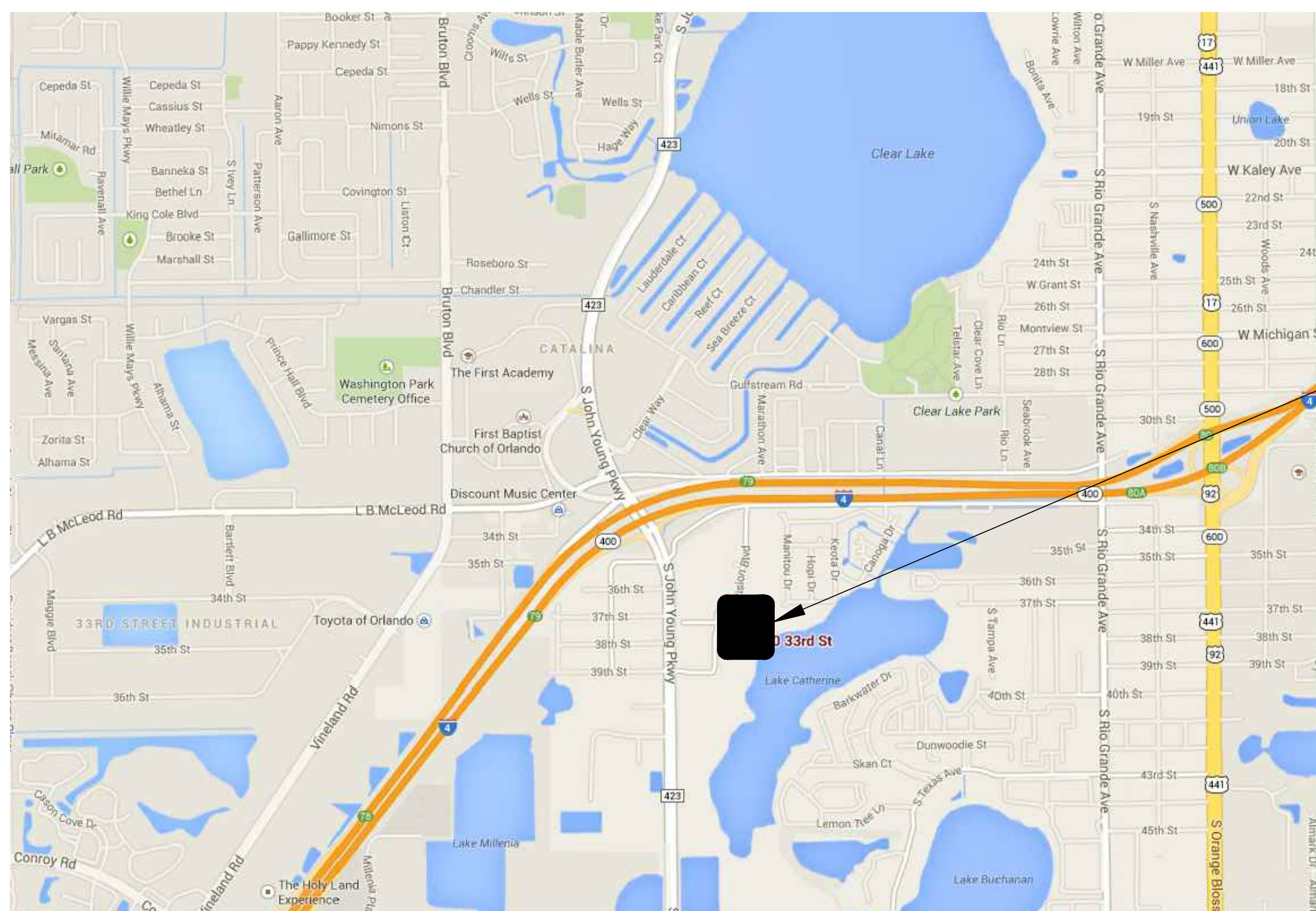

PROJECT LOCATION
ORANGE COUNTY CORRECTIONS
HORIZON BUILDING
3723 VISION BLVD,
Orlando, FL 32839

PROJECT SUMMARY

REPLACEMENT OF THE EXTERIOR SOUTH
EAST AND NORTH WEST HORIZON BUILDING
SECURITY SCREENS. MODIFICATION OF
EXISTING ROOF DESIGN OVER RECREATION
YARDS

LOCATION MAP

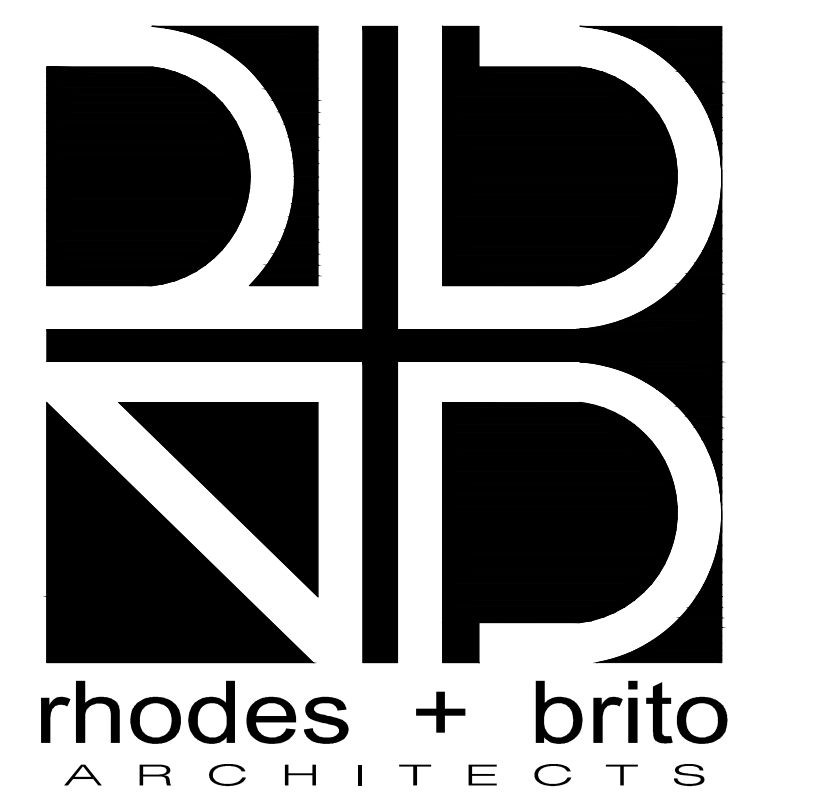

605 E. ROBINSON ST SUITE 750
ORLANDO, FL 32801

PH (407) 648 - 7288

AA 000 - 2809

www.rbarchitects.com

PROJECT DESIGN TEAM

Architectural

Rhodes & Brito Architects, Inc.
605 East Robinson St, Suite 750
Orlando, FL 32801
ph. (407) 648-7288

Structural

Advanced Structural Design, Inc
1265 South Semoran Blvd, Suite 1201
Winter Park, Florida 32792
ph. (407) 677-5836
fax (407) 677-5894

Architect of Record	Engineer of Record																		
Joseph Baker, AIA AR 0013186	Jamshid Hakimian, PE PE 46613																		

PROFESSIONAL SEALS

DIMENSIONING

1. WHEN A ROOM/BUILDING/OBJECT CENTERLINE IS INDICATED, ONLY ONE SIDE OF ELEMENT MAY BE DIMENSIONED

2. DOOR LOCATION
DOORS ARE LOCATED BY ONE OF THE FOLLOWING:
A. ONE JAMB FACE LOCATED BY A PARTITION AT RIGHT ANGLE.

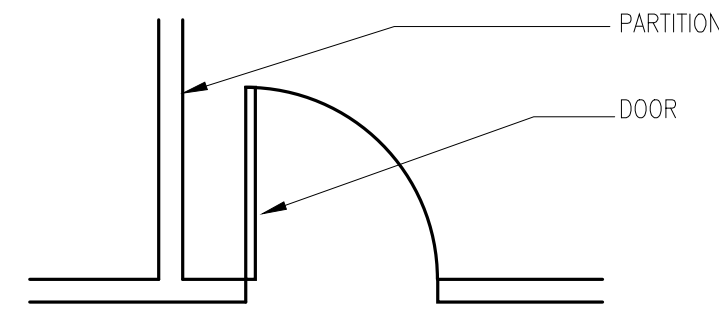

B. AS DIMENSIONED

3. PARTITION FINISH FACE ON COLUMN OR GRID LINE WILL NOT BE DIMENSIONED ON SMALL SCALE PLANS BUT WILL BE DRAWN ACCORDINGLY ON LARGER SCALE DRAWINGS.

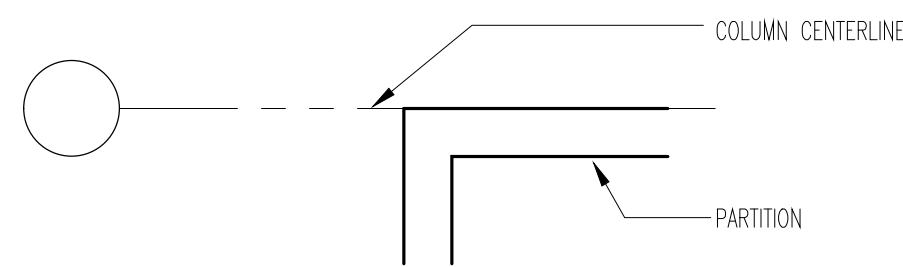

4. PARTITIONS WITH FINISH FACE FLUSH WITH FINISH FACE OF COLUMN WILL NOT BE DRAWN ON SMALL SCALE PLANS BUT WILL BE DRAWN ACCORDINGLY ON LARGER SCALE DRAWINGS.

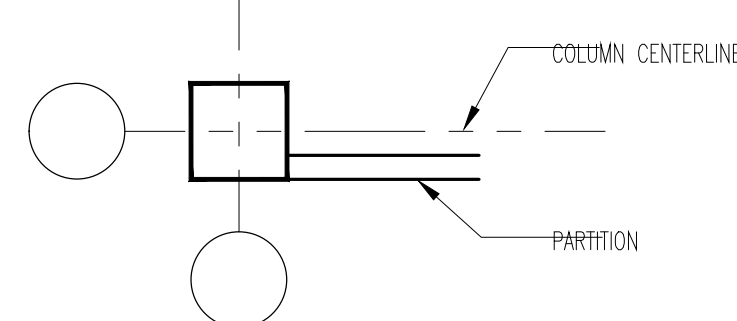

5. PARTITIONS CENTERED ON COLUMNS OR GRID LINES WILL NOT BE DIMENSIONED ON SMALL SCALE PLANS BUT WILL BE DRAWN ACCORDINGLY ON LARGER SCALE DRAWINGS.

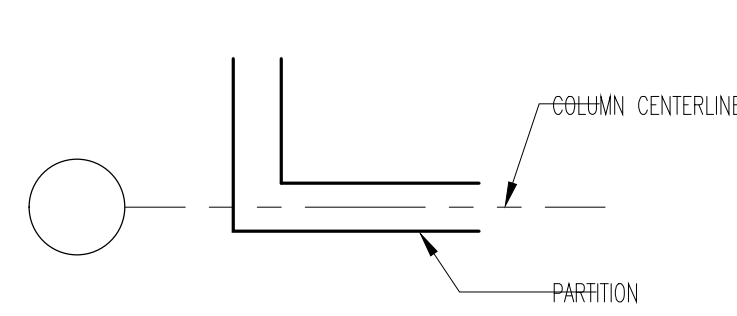

6. PARTITIONS ARE DIMENSIONED TO FACE OF STUDS, FACE OF CMU AND FACE OF BLOCK UNLESS INDICATED OTHERWISE

7. DIMENSIONS ARE INDICATED ON DRAWINGS, DO NOT SCALE DRAWINGS

DRAWING SYMBOL LEGEND

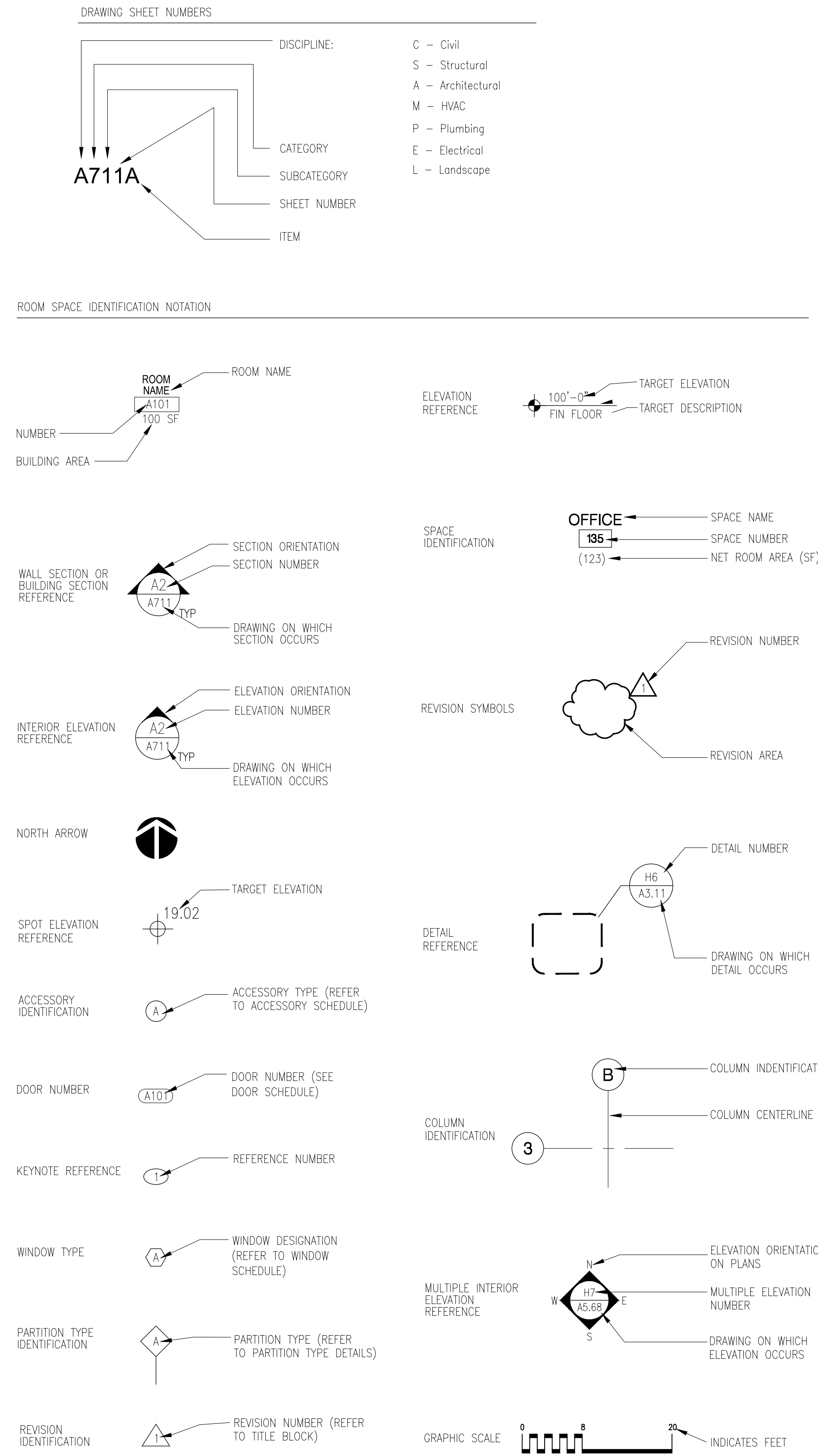

MATERIALS LEGEND

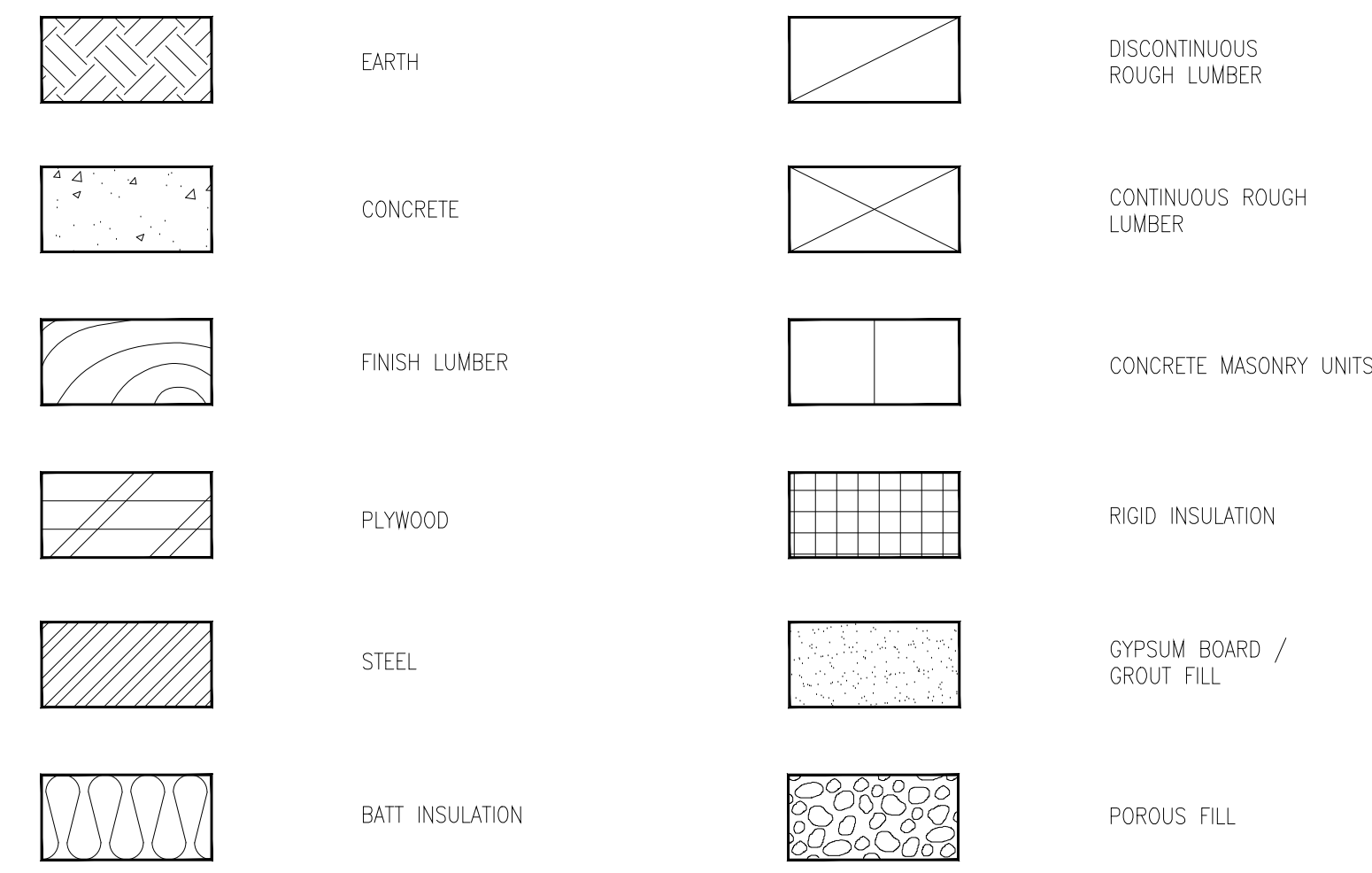

DRAWING FORMAT

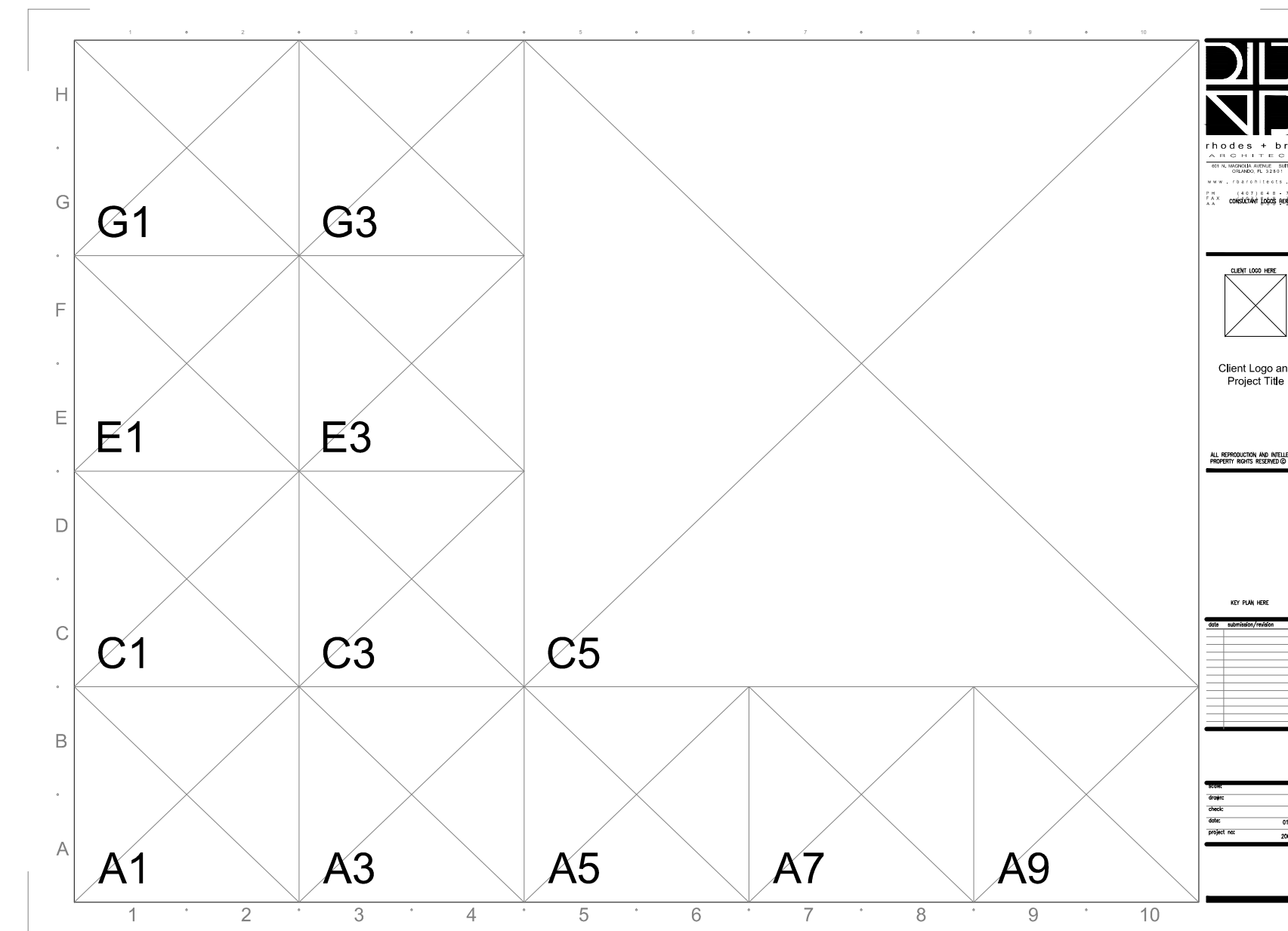

EACH SHEET IS DIVIDED INTO A GRID. AN ALPHA-NUMERIC GRID COORDINATE SYSTEM IS USED TO ORGANIZE THE DRAWING TITLES. DRAWING TITLES ARE NUMBERED ACCORDING TO ITS LOCATION ON THE GRID. THE LOWER LEFT HAND CORNER GRID OF THE DRAWING IS USED AS THE IDENTIFICATION NUMBER (SEE DIAGRAM).

LIST OF ABBREVIATIONS

AB	ANCHOR BOLT	CAB	CABINET	DBL	DOUBLE	FA	FIRE ALARM	HB	HOSE BIBB	LAB	LABORATORY	N	NORTH	QT	QUARRY TILE	S	SOUTH	UC	UNDERCUT
ABK	ABOVE	CB	CATEGORY	DEM	DEMOLITION	FAS	FASION, FASTENER	HBD	HARBORWARD	LAM	LAMINATE	NA	NOT APPLICABLE	QTR	QUARTER	SC	SOLID CORE	UL	UNDERWRITERS LABORATORY
A/C	AIR CONDITIONING	CBT	CASIT BASIN	DEP	DEPRESSED	FB	FACE BRICK	HC	HOLLOW CORE	LAV	LAVATORY	NGVD	NATIONAL GEODETIC			SCHED	SCHEDULE	UNF	UNFINISHED
ACC	ACCESS	CC	CENTER TO CENTER	DEPT	DEPARTMENT	FBO	FURNISHED BY OTHERS	HJ	HEAVY DUTY	LBB	LABEL	NOT	NOT IN CONTRACT	SECT	SECTION	UNO	UNLESS NOTED	UR	URNAL
ACPL	ACOUSTICAL PLASTER	C/C	CORNER GUARD	DF	DRINKING FOUNTAIN	FCD	FLOOR CLEAN OUT	HJL	HEAD JOINT	LEF	LEFT	NO	NUMBER	R	RISER	SFLQ	SQUARE FOOT	VAT	VINYL ASBESTOS TILE
AD	ACROUSTICAL TILE	CHAM	CHAMFER	DI	DOUBLE HUNG	FE	FIRE EXTINGUISHER	LF	LEFT HAND	RF	RIGHT HAND	NOM	NOMINAL	RA	RETURN AIR	SFG	SAFETY GLASS	VAR	VARIATION
ADD	ADDITIONAL	CHM	CHAMFER	DI	DOUBLE HUNG	FE	FIRE EXTINGUISHER	RF	RIGHT HAND	RF	REFLECTED	NOM	NOMINAL	RAD	RADIUM	SGL	SINGLE	VB	VAPOR BARRIER
ADD	ADDITIONAL	CHM	CHAMFER	DI	DOUBLE HUNG	FE	FIRE EXTINGUISHER	RF	RIGHT HAND	RF	REFLECTED	NOM	NOMINAL	RAD	RADIUM	SGL	SINGLE	VB	VAPOR BARRIER
ADH	ADHESIVE	CHM	CHAMFER	DI	DOUBLE HUNG	FE	FIRE EXTINGUISHER	RF	RIGHT HAND	RF	REFLECTED	NOM	NOMINAL	RAD	RADIUM	SGL	SINGLE	VB	VAPOR BARRIER
ADJ	ADJUSTABLE	CHM	CHAMFER	DI	DOUBLE HUNG	FE	FIRE EXTINGUISHER	RF	RIGHT HAND	RF	REFLECTED	NOM	NOMINAL	RAD	RADIUM	SGL	SINGLE	VB	VAPOR BARRIER
AE	ARCHITECT/ENGINEER	CHM	CHAMFER	DI	DOUBLE HUNG	FE	FIRE EXTINGUISHER	RF	RIGHT HAND	RF	REFLECTED	NOM	NOMINAL	RAD	RADIUM	SGL	SINGLE	VB	VAPOR BARRIER
A/E	ARCHITECT/ENGINEER	CHM	CHAMFER	DI	DOUBLE HUNG	FE	FIRE EXTINGUISHER	RF	RIGHT HAND	RF	REFLECTED	NOM	NOMINAL	RAD	RADIUM	SGL	SINGLE	VB	VAPOR BARRIER
AFF	ABOVE FINISHED FLOOR	CHM	CHAMFER	DI	DOUBLE HUNG	FE	FIRE EXTINGUISHER	RF	RIGHT HAND	RF	REFLECTED	NOM	NOMINAL	RAD	RADIUM	SGL	SINGLE	VB	VAPOR BARRIER
AHJ	ARCHITECT/ENGINEER	CHM	CHAMFER	DI	DOUBLE HUNG	FE	FIRE EXTINGUISHER	RF	RIGHT HAND	RF	REFLECTED	NOM	NOMINAL	RAD	RADIUM	SGL	SINGLE	VB	VAPOR BARRIER
ALT	ALTERNATE	CHM	CHAMFER	DI	DOUBLE HUNG	FE	FIRE EXTINGUISHER	RF	RIGHT HAND	RF	REFLECTED	NOM	NOMINAL	RAD	RADIUM	SGL	SINGLE	VB	VAPOR BARRIER
ALU	ALUMINUM	CHM	CHAMFER	DI	DOUBLE HUNG	FE	FIRE EXTINGUISHER	RF	RIGHT HAND	RF	REFLECTED	NOM	NOMINAL	RAD	RADIUM	SGL	SINGLE	VB	VAPOR BARRIER
AND	AND	CHM	CHAMFER	DI	DOUBLE HUNG	FE	FIRE EXTINGUISHER	RF	RIGHT HAND	RF	REFLECTED	NOM	NOMINAL	RAD	RADIUM	SGL	SINGLE	VB	VAPOR BARRIER
AP	APPROXIMATE	CHM	CHAMFER	DI	DOUBLE HUNG	FE	FIRE EXTINGUISHER	RF	RIGHT HAND	RF	REFLECTED	NOM	NOMINAL	RAD	RADIUM	SGL	SINGLE	VB	VAPOR BARRIER
APR	ARCHITECTURAL	CHM	CHAMFER	DI	DOUBLE HUNG	FE	FIRE EXTINGUISHER	RF	RIGHT HAND	RF	REFLECTED	NOM	NOMINAL	RAD	RADIUM	SGL	SINGLE	VB	VAPOR BARRIER
ASB	ASBESTOS	CHM	CHAMFER	DI	DOUBLE HUNG	FE	FIRE EXTINGUISHER	RF	RIGHT HAND	RF	REFLECTED	NOM	NOMINAL	RAD	RADIUM	SGL	SINGLE	VB	VAPOR BARRIER
ASPH	ASPHALT	CHM	CHAMFER	DI	DOUBLE HUNG	FE	FIRE EXTINGUISHER	RF	RIGHT HAND	RF	REFLECTED	NOM	NOMINAL	RAD	RADIUM	SGL	SINGLE	VB	VAPOR BARRIER
AUT	AUTOMATIC	CHM	CHAMFER	DI	DOUBLE HUNG	FE	FIRE EXTINGUISHER	RF	RIGHT HAND	RF	REFLECTED	NOM	NOMINAL	RAD	RADIUM	SGL	SINGLE	VB	VAPOR BARRIER
AUV	AUDIO VISUAL	CHM	CHAMFER	DI	DOUBLE HUNG	FE	FIRE EXTINGUISHER	RF	RIGHT HAND	RF	REFLECTED	NOM	NOMINAL	RAD	RADIUM	SGL	SINGLE	VB	VAPOR BARRIER
BD	BOARD	CHM	CHAMFER	DI	DOUBLE HUNG	FE	FIRE EXTINGUISHER	RF	RIGHT HAND	RF	REFLECTED	NOM	NOMINAL	RAD	RADIUM	SGL	SINGLE	VB	VAPOR BARRIER
BEL	BELOW	CHM	CHAMFER	DI	DOUBLE HUNG	FE	FIRE EXTINGUISHER	RF	RIGHT HAND	RF	REFLECTED	NOM	NOMINAL	RAD	RADIUM	SGL	SINGLE	VB	VAPOR BARRIER
BET	BETWEEN	CHM	CHAMFER	DI	DOUBLE HUNG	FE	FIRE EXTINGUISHER	RF	RIGHT HAND	RF	REFLECTED	NOM	NOMINAL	RAD	RADIUM	SGL	SINGLE	VB	VAPOR BARRIER
BLK	BLOCK	CHM	CHAMFER	DI	DOUBLE HUNG	FE	FIRE EXTINGUISHER	RF	RIGHT HAND	RF	REFLECTED	NOM	NOMINAL	RAD	RADIUM	SGL	SINGLE	VB	VAPOR BARRIER
BLK(G)	BLOCK (GLASS)	CHM	CHAMFER	DI	DOUBLE HUNG	FE	FIRE EXTINGUISHER	RF	RIGHT HAND	RF	REFLECTED	NOM	NOMINAL	RAD	RADIUM	SGL	SINGLE	VB	VAPOR BARRIER
BM	BENCH MARK	CHM	CHAMFER	DI	DOUBLE HUNG	FE	FIRE EXTINGUISHER	RF	RIGHT HAND	RF	REFLECTED	NOM	NOMINAL	RAD	RADIUM	SGL	SINGLE	VB	VAPOR BARRIER
BO	BOTTOM	CHM	CHAMFER	DI	DOUBLE HUNG	FE	FIRE EXTINGUISHER	RF	RIGHT HAND	RF	REFLECTED	NOM	NOMINAL	RAD	RADIUM	SGL	SINGLE	VB	VAPOR BARRIER
BOT	BOTTOM	CHM	CHAMFER	DI	DOUBLE HUNG	FE	FIRE EXTINGUISHER	RF	RIGHT HAND	RF	REFLECTED	NOM	NOMINAL	RAD	RADIUM	SGL	SINGLE	VB	VAPOR BARRIER
BRK	BEARING	CHM	CHAMFER	DI	DOUBLE HUNG	FE	FIRE EXTINGUISHER	RF	RIGHT HAND	RF	REFLECTED	NOM	NOMINAL	RAD	RADIUM	SGL	SINGLE	VB	VAPOR BARRIER
BRK PL	BEARING PLATE	CHM	CHAMFER	DI	DOUBLE HUNG	FE	FIRE EXTINGUISHER	RF	RIGHT HAND	RF	REFLECTED	NOM	NOMINAL	RAD	RADIUM	SGL	SINGLE	VB	VAPOR BARRIER
BRK	BEARING	CHM	CHAMFER	DI	DOUBLE HUNG	FE	FIRE EXTINGUISHER	RF	RIGHT HAND	RF	REFLECTED	NOM	NOMINAL	RAD	RADIUM	SGL	SINGLE	VB	VAPOR BARRIER
BS	BOTH SIDES	CHM	CHAMFER	DI	DOUBLE HUNG	FE	FIRE EXTINGUISHER	RF	RIGHT HAND	RF	REFLECTED	NOM	NOMINAL	RAD	RADIUM	SGL	SINGLE	VB	VAPOR BARRIER
BSLT	BUILDING SETBACK LINE	CHM	CHAMFER	DI	DOUBLE HUNG	FE	FIRE EXTINGUISHER	RF	RIGHT HAND	RF	REFLECTED	NOM	NOMINAL	RAD	RADIUM	SGL	SINGLE	VB	VAPOR BARRIER
BSMT	BASEMENT	CHM	CHAMFER	DI	DOUBLE HUNG	FE	FIRE EXTINGUISHER	RF	RIGHT HAND	RF	REFLECTED	NOM	NOMINAL	RAD	RADIUM	SGL	SINGLE	VB	VAPOR BARRIER
BUR	BURIED UP ROOFING	CHM	CHAMFER	DI	DOUBLE HUNG	FE	FIRE EXTINGUISHER	RF	RIGHT HAND	RF	REFLECTED	NOM	NOMINAL	RAD	RADIUM	SGL	SINGLE	VB	VAPOR BARRIER
BVL	BURIED	CHM	CHAMFER	DI	DOUBLE HUNG	FE	FIRE EXTINGUISHER	RF	RIGHT HAND	RF	REFLECTED	NOM	NOMINAL	RAD	RADIUM	SGL	SINGLE	VB	VAPOR BARRIER
BW	BOTH WAYS	CHM	CHAMFER	DI	DOUBLE HUNG	FE	FIRE EXTINGUISHER	RF	RIGHT HAND	RF	REFLECTED	NOM	NOMINAL	RAD	RADIUM	SGL	SINGLE	VB	VAPOR BARRIER
CA	CASING	CHM	CHAMFER	DI	DOUBLE HUNG	FE	FIRE EXTINGUISHER	RF	RIGHT HAND	RF	REFLECTED	NOM	NOMINAL	RAD	RADIUM	SGL	SINGLE	VB	VAPOR BARRIER
CB	CASING	CHM	CHAMFER	DI	DOUBLE HUNG	FE	FIRE EXTINGUISHER	RF	RIGHT HAND	RF	REFLECTED	NOM	NOMINAL	RAD	RADIUM	SGL	SINGLE	VB	VAPOR BARRIER
CC	CASING	CHM	CHAMFER	DI	DOUBLE HUNG	FE	FIRE EXTINGUISHER	RF	RIGHT HAND	RF	REFLECTED	NOM	NOMINAL	RAD	RADIUM	SGL	SINGLE	VB	VAPOR BARRIER
CD	CASING	CHM	CHAMFER	DI	DOUBLE HUNG	FE	FIRE EXTINGUISHER	RF	RIGHT HAND	RF	REFLECTED	NOM	NOMINAL	RAD	RADIUM	SGL	SINGLE	VB	VAPOR BARRIER
CE	CASING	CHM	CHAMFER	DI	DOUBLE HUNG	FE	FIRE EXTINGUISHER	RF	RIGHT HAND	RF	REFLECTED	NOM	NOMINAL	RAD	RADIUM	SGL	SINGLE	VB	VAPOR BARRIER
CF	CASING	CHM	CHAMFER	DI	DOUBLE HUNG	FE	FIRE EXTINGUISHER	RF	RIGHT HAND	RF	REFLECTED	NOM	NOMINAL	RAD	RADIUM	SGL	SINGLE	VB	VAPOR BARRIER
CG	CASING	CHM	CHAMFER	DI	DOUBLE HUNG	FE	FIRE EXTINGUISHER	RF	RIGHT HAND	RF	REFLECTED	NOM	NOMINAL	RAD	RADIUM	SGL	SINGLE	VB	VAPOR BARRIER
CH	CASING	CHM	CHAMFER	DI	DOUBLE HUNG	FE	FIRE EXTINGUISHER	RF	RIGHT HAND	RF	REFLECTED	NOM	NOMINAL	RAD	RADIUM	SGL	SINGLE	VB	VAPOR BARRIER
CI	CASING	CHM	CHAMFER	DI	DOUBLE HUNG	FE	FIRE EXTINGUISHER	RF	RIGHT HAND	RF	REFLECTED	NOM	NOMINAL	RAD	RADIUM	SGL	SINGLE	VB	VAPOR BARRIER
CJ	CASING	CHM	CHAMFER	DI	DOUBLE HUNG	FE	FIRE EXTINGUISHER	RF	RIGHT HAND	RF	REFLECTED	NOM	NOMINAL	RAD	RADIUM	SGL	SINGLE	VB	VAPOR BARRIER
CK	CASING	CHM	CHAMFER	DI	DOUBLE HUNG	FE	FIRE EXTINGUISHER	RF	RIGHT HAND	RF	REFLECTED	NOM	NOMINAL	RAD	RADIUM	SGL	SINGLE	VB	VAPOR BARRIER
CL	CASING	CHM	CHAMFER	DI	DOUBLE HUNG	FE	FIRE EXTINGUISHER	RF	RIGHT HAND	RF	REFLECTED	NOM	NOMINAL	RAD	RADIUM	SGL	SINGLE	VB	VAPOR BARRIER
CM	CASING	CHM	CHAMFER	DI	DOUBLE HUNG	FE	FIRE EXTINGUISHER	RF	RIGHT HAND	RF	REFLECTED	NOM	NOMINAL	RAD	RADIUM	SGL	SINGLE	VB	VAPOR BARRIER
CM	CASING	CHM	CHAMFER	DI	DOUBLE HUNG	FE	FIRE EXTINGUISHER	RF	RIGHT HAND	RF	REFLECTED	NOM	NOMINAL	RAD	RADIUM	SGL	SINGLE	VB	VAPOR BARRIER
CO	CASING	CHM	CHAMFER	DI	DOUBLE HUNG	FE	FIRE EXTINGUISHER	RF	RIGHT HAND	RF	REFLECTED	NOM	NOMINAL	RAD	RADIUM	SGL	SINGLE	VB	VAPOR BARRIER
CP	CASING	CHM	CHAMFER	DI	DOUBLE HUNG	FE	FIRE EXTINGUISHER	RF	RIGHT HAND	RF	REFLECTED	NOM	NOMINAL	RAD	RADIUM	SGL	SINGLE	VB	VAPOR BARRIER
CR	CASING	CHM	CHAMFER	DI	DOUBLE HUNG	FE	FIRE EXTINGUISHER	RF	RIGHT HAND	RF	REFLECTED	NOM	NOMINAL	RAD	RADIUM	SGL	SINGLE	VB	VAPOR BARRIER
CS	CASING	CHM	CHAMFER	DI	DOUBLE HUNG	FE	FIRE EXTINGUISHER	RF	RIGHT HAND	RF	REFLECTED	NOM	NOMINAL	RAD	RADIUM	SGL	SINGLE	VB	VAPOR BARRIER
CT	CASING	CHM	CHAMFER	DI	DOUBLE HUNG	FE	FIRE EXTINGUISHER	RF	RIGHT HAND	RF	REFLECTED	NOM	NOMINAL	RAD	RADIUM	SGL	SINGLE	VB	VAPOR BARRIER
CT	CASING	CHM	CHAMFER	DI	DOUBLE HUNG	FE	FIRE EXTINGUISHER	RF	RIGHT HAND	RF	REFLECTED	NOM	NOMINAL	RAD	RADIUM	SGL	SINGLE	VB	VAPOR BARRIER
CY	CASING	CHM	CHAMFER	DI	DOUBLE HUNG	FE	FIRE EXTINGUISHER	RF	RIGHT HAND	RF	REFLECTED	NOM	NOMINAL	RAD	RADIUM	SGL	SINGLE	VB	VAPOR BARRIER
CA	CASING	CHM	CHAMFER	DI	DOUBLE HUNG	FE	FIRE EXTINGUISHER	RF	RIGHT HAND	RF	REFLECTED	NOM	NOMINAL	RAD	RADIUM	SGL	SINGLE	VB	VAPOR BARRIER
CB	CASING	CHM	CHAMFER	DI	DOUBLE HUNG	FE	FIRE EXTINGUISHER	RF	RIGHT HAND	RF	REFLECTED	NOM	NOMINAL	RAD	RADIUM	SGL	SINGLE	VB	VAPOR BARRIER
CC	CASING	CHM	CHAMFER																

DEMOLITION KEYNOTES

- 1 REMOVE SECTION OF EXISTING ROOF COATING TO ALLOW FOR INSTALLATION OF NEW CURB AND FLASHING
- 2 REMOVE SECTION OF EXISTING FLASHING AND EXPANSION JOINT MATERIAL TO PREPARE FOR NEW CURB W/ EXPANSION JOINT SYSTEM TO TIE INTO THE EXISTING JOINT

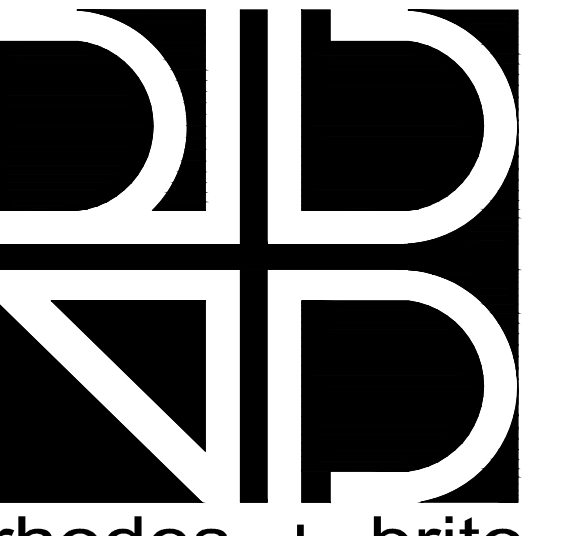

rhodes + brito
ARCHITECTS
601 N. MAGNOLIA AVENUE SUITE 100
ORLANDO, FL 32801

PH (407) 648 - 7288
FAX (407) 648 - 7289
AA 000 - 2809
www.rbarchitects.com



ORANGE COUNTY
ORANGE COUNTY CORRECTIONS
HORIZON BUILDING
SECURITY SCREEN REPLACEMENT
ORLANDO, FLORIDA
ISSUED FOR
PERMIT AND CONSTRUCTION
ALL REPRODUCTION AND INTELLECTUAL
PROPERTY RIGHTS RESERVED ©

SEAL

JOSEPH BAKER, AIA FL. REG. NO. AR0013188
DATE:

date	submission/revision	no.

**DEMOLITION
ROOF PLANS**

scale: _____
drawn: _____ AR
check: _____ FR
date: 09/29/2015
project no: 12002.013

D203

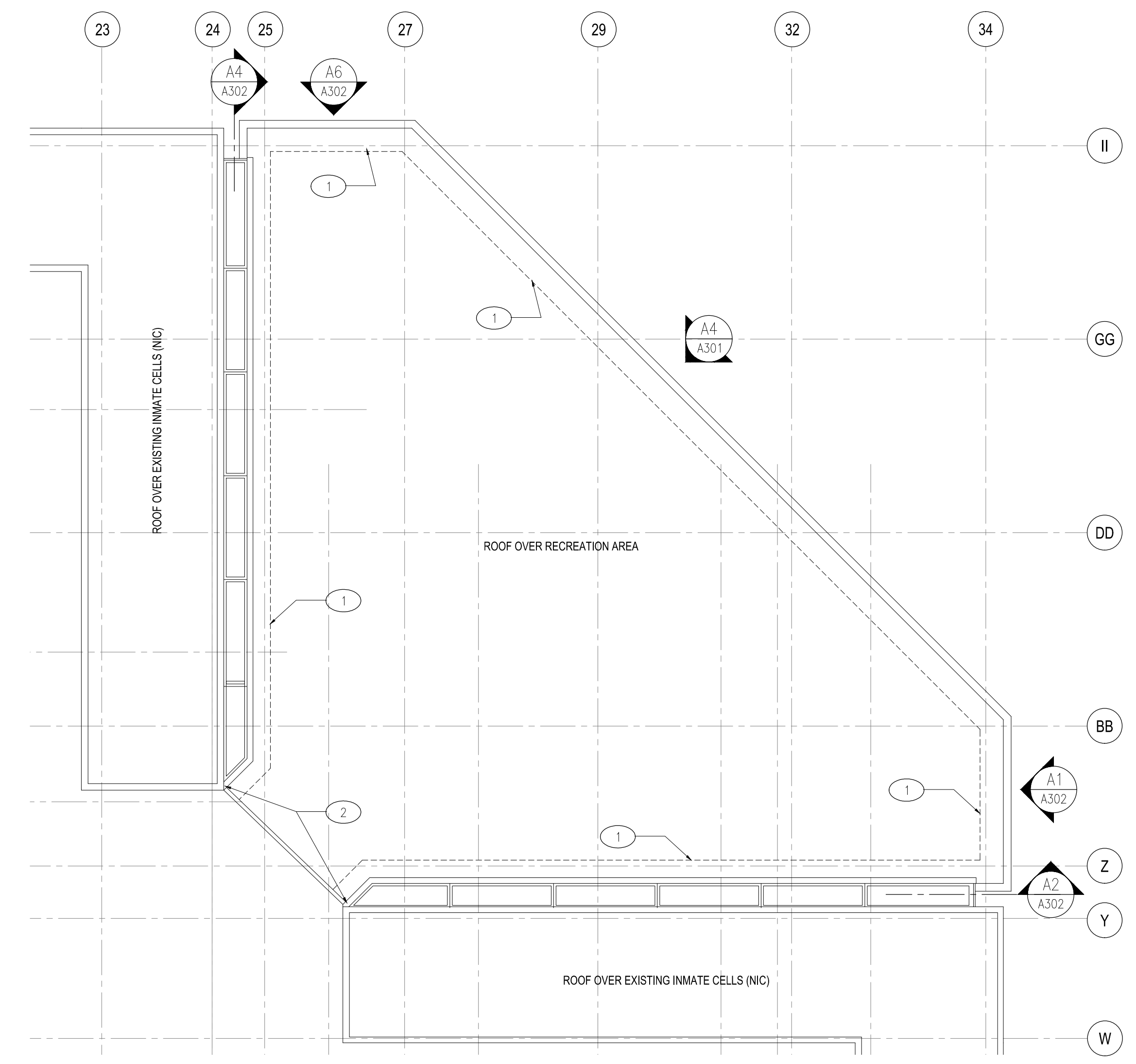

**SOUTHEAST CORNER
ROOF PLAN**
scale: 1/8" = 1'-0"

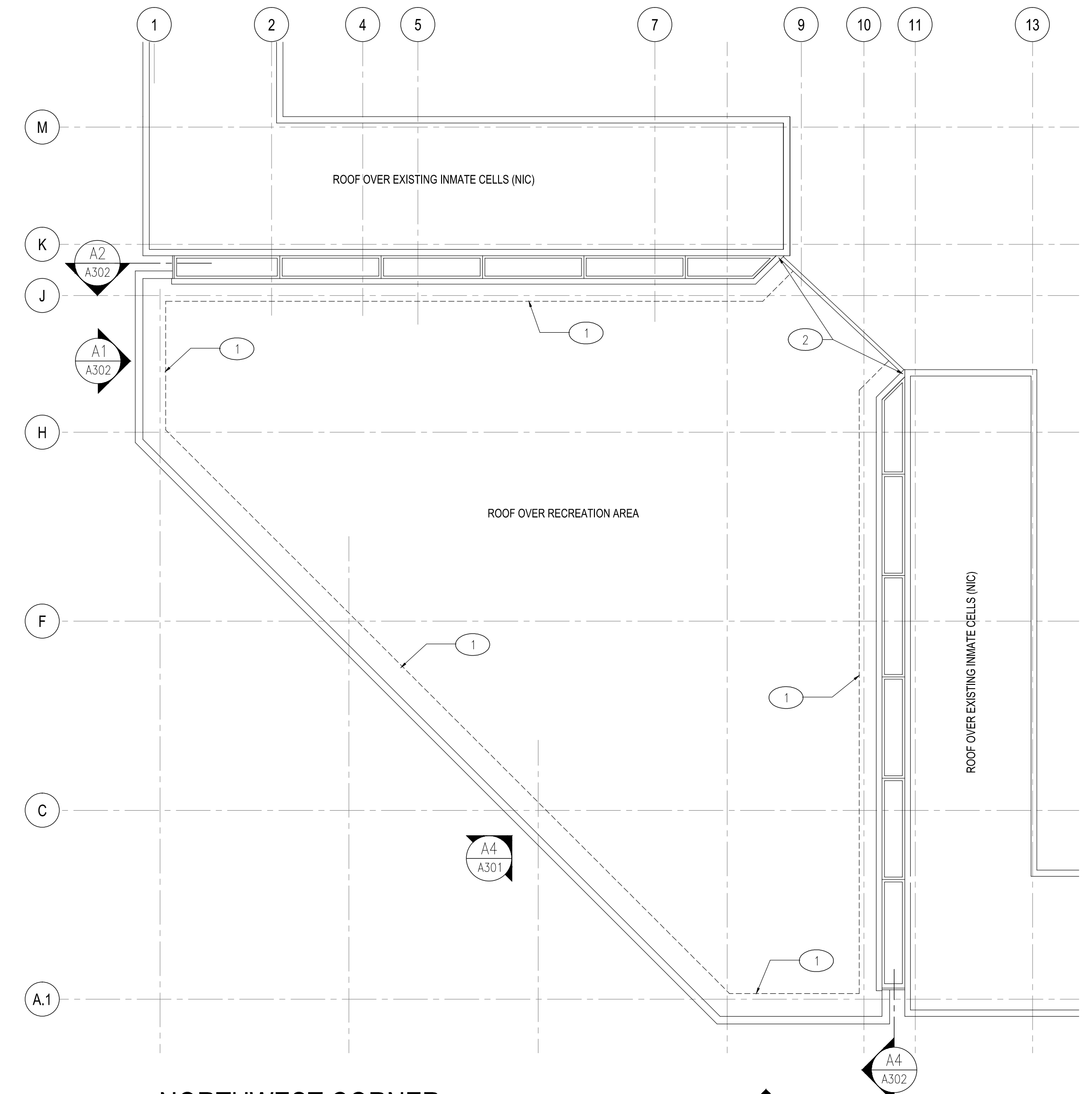

**NORTHWEST CORNER
ROOF PLAN**
scale: 1/8" = 1'-0"

1 2 3 4 5 6 7 8 9 10

1 2 3 4 5 6 7 8 9 10

H
G
F
E
D
C
B
A



E4
A301 SOUTHEAST/NORTHWEST ELEVATION
scale: 1/8" = 1'-0"

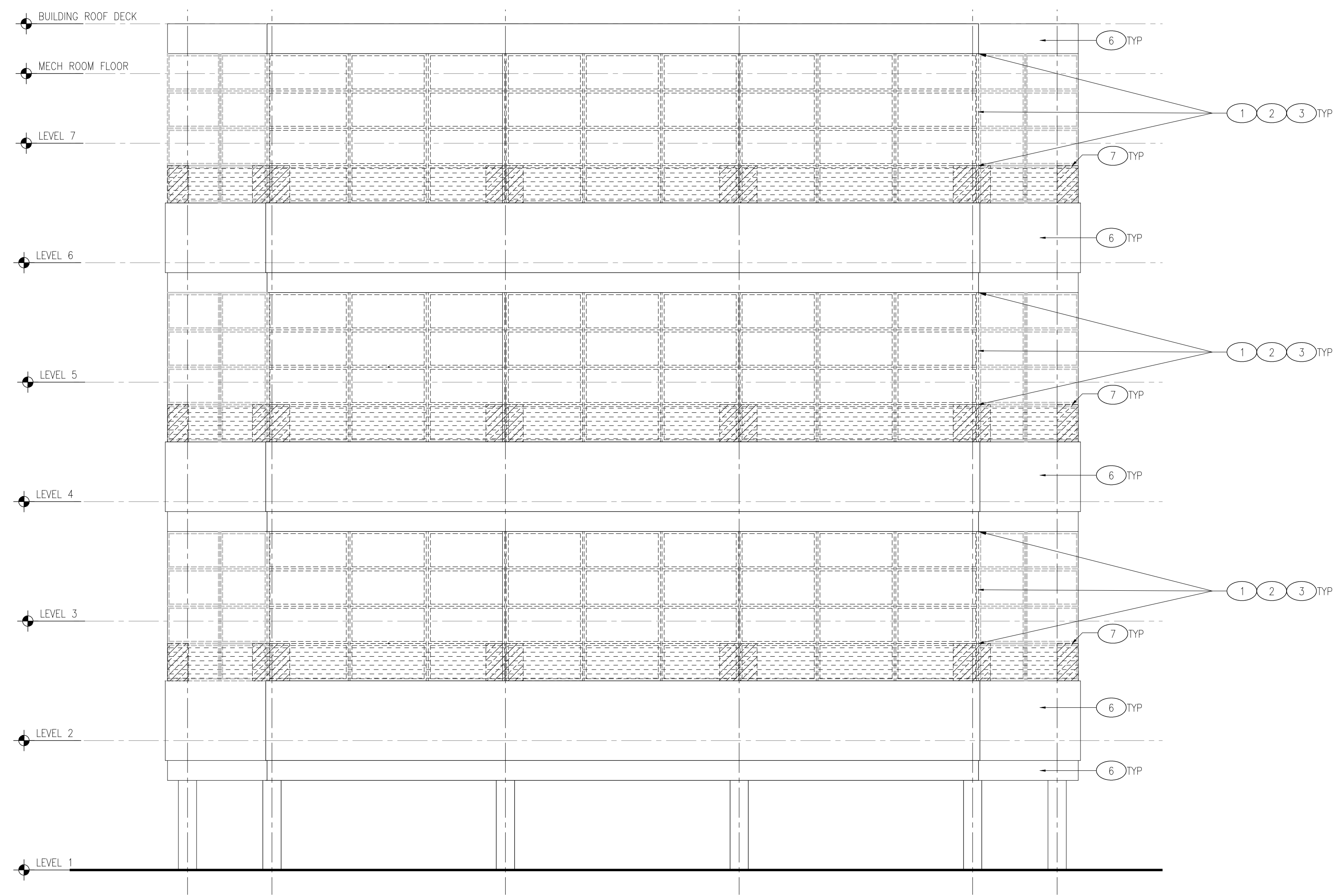

A4
A301 EXISTING SOUTHEAST/NORTHWEST DEMO ELEVATION
scale: 1/8" = 1'-0"

GENERAL NOTES

1. ALL STAINLESS STEEL NOTES REFER TO TYPE 316 STAINLESS STEEL

DEMOLITION ELEVATION KEYNOTES

- 1. CONTRACTOR IS TO REMOVE ALL EXISTING SECURITY SCREENS W/ SUPPORTING FRAMEWORK
- 2. CONTRACTOR IS TO REMOVE ALL EXISTING CONNECTING ANGLES/PLATES AS REQUIRED
- 3. ALL THE EXISTING EMBED PLATES USED FOR SUPPORTING THE PERIMETER SECURITY SCREENS ARE TO HAVE EXISTING PAINT REMOVED AND BE CLEANED AND PREPARED TO RECEIVE NEW FRAMES AND SECURITY SCREEN ENCLOSURES
- 4. THE EXISTING EXPOSED STRUCTURE WHICH ACTS AS THE CEILING OF THE RECREATION AREA IS TO BE PRESSURE WASHED AND PREPARED TO RECEIVE A NEW PAINT FINISH
- 5. THE EXISTING EMBED PLATES ON THE BOTTOM OF THE EXPOSED STRUCTURAL BEAM ARE TO BE CLEANED / SANDED TO BARE METAL IN PREPARATION FOR NEW PRIMER / PAINT FINISH
- 6. EXISTING PRECAST PANELS TO REMAIN. PROTECT NEW PAINT FINISH FROM DAMAGE. CONTRACTOR WILL REPAIR / REPAINT ANY DAMAGE FROM DEMOLITION / NEW CONSTRUCTION PHASES OF WORK
- 7. DEMOLISH STEEL PLATE ATTACHED TO SECURITY SCREEN FRAME

ELEVATION KEYNOTES

- A. 1"x3" GALVANIZED STEEL SECURITY MESH W/ SUPPORTING FRAMEWORK, SEE STRUCTURAL ENGINEER'S DRAWINGS
- B. PROVIDE CONNECTING ANGLES / PLATES AS SHOWN BY STRUCTURAL ENGINEER
- C. NEW PAINT FINISH ON CEILING, AND STRUCTURE
- D. NEW PRIMER / PAINT FINISH ON EXISTING EMBED PLATES
- E. 1/4"x1/4" GALVANIZED STEEL SECURITY MESH OVER 1"x1" GALVANIZED STEEL SECURITY MESH
- F. 1/4" GALVANIZED STEEL PLATE WITHIN SECURITY SCREEN MESH FRAME
- G. EXISTING FRAME AND STEEL PLATE TO REMAIN. PROTECT FROM DAMAGE



ORANGE COUNTY
ORANGE COUNTY CORRECTIONS
HORIZON BUILDING
SECURITY SCREEN REPLACEMENT
ORLANDO, FLORIDA
ISSUED FOR
PERMIT AND CONSTRUCTION
ALL REPRODUCTION AND INTELLECTUAL
PROPERTY RIGHTS RESERVED ©

SEAL

JOSEPH BAKER, AIA FL. REG. NO. AR0013188
DATE:

date	submission/revision	no.

ELEVATIONS

scale: _____
drawn: _____ AR
check: _____ FR
date: _____ 09/29/2015
project no: _____ 12002.013

A301

