

**R&R PACKAGE 1 PUMP STATION IMPROVEMENTS
University at Rouse PS #3365, Lena Street PS #3309,
Allison Oaks PS #3893, Greenview Pines PS #3887 and
Bradford Cove PS #3890**



**TECHNICAL SPECIFICATIONS
BID SET**

**ORANGE COUNTY
UTILITIES DEPARTMENT**

Prepared By:

**BFA Environmental Consultants, Inc.
1230 E. Hillcrest Street
Orlando, Florida 32803**

JULY 2014

R&R PACKAGE 1 PUMP STATION IMPROVEMENTS
University at Rouse PS #3365, Lena Street PS #3309, Allison Oaks PS #3893, Greenview
Pines PS #3887 and Bradford Cove PS #3890

TECHNICAL SPECIFICATIONS

Table of Contents

DIVISION 1 – GENERAL REQUIREMENTS

01001	General Work Requirements
01010	Summary of Work
01021	Soils Report and Other Information
01025	Measurement and Payment
01027	Applications for Payment
01050	Surveying and Field Engineering
01065	Permits and Fees
01070	Abbreviations and Symbols
01091	Reference Specifications
01200	Project Meetings
01300	Submittals
01310	Progress Schedules
01370	Schedule of Values
01380	Audio-Visual Documentation
01400	Quality Control
01410	Testing and Laboratory Services
01516	Collection System Bypass
01560	Erosion and Sedimentation Control
01570	Maintenance of Traffic
01580	Project Identification and Signs
01590	Construction Field Office
01610	Delivery Storage and Handling
01650	Pump Station Start-Up and Testing
01700	Project Closeout
01720	Project Record Documents
01730	Pump Station Operation and Maintenance Manual
01740	Warranties and Bonds

DIVISION 2 – SITE WORK

02050	Demolition of Existing Structures
02080	Abandonment, Removal, and Salvage or Disposal of Existing Pipe
02100	Temporary Erosion and Sedimentation Control
02140	Dewatering
02215	Finish Grading
02220	Excavating, Backfilling, and Compacting
02576	Concrete Sidewalks and Driveways
02578	Solid Sodding

R&R PACKAGE 1 PUMP STATION IMPROVEMENTS
University at Rouse PS #3365, Lena Street PS #3309, Allison Oaks PS #3893, Greenview
Pines PS #3887 and Bradford Cove PS #3890

TECHNICAL SPECIFICATIONS

Table of Contents

DIVISION 2 (CONTINUED)

02661	Wastewater Force Mains
02761	Cleaning Sanitary Sewer Systems
02762	Televising Sanitary Sewer Systems
02771	Cure-in-Place Pipe for Sanitary Sewer Renewal
02774	Wastewater Gravity Collection System
02775	Wastewater Manhole Rehabilitation
02784	Chain Link Fences and Gates

DIVISION 3 – CONCRETE

03100	Concrete Formwork
03200	Concrete Reinforcement
03300	Cast-in-Place Concrete
03410	Precast Concrete Structures
03600	Grouting

DIVISION 4 – MASONRY (NOT USED)

DIVISION 5 – METALS

05500	Miscellaneous Metals
-------	----------------------

DIVISION 6 – WOOD, PLASTICS AND COMPOSITES (NOT USED)

DIVISION 7 – THERMAL AND MOISTURE PROTECTION (NOT USED)

DIVISION 8 – OPENINGS

08350	Access Hatch Doors
-------	--------------------

DIVISION 9 – FINISHES

09901	Coatings and Linings
09905	Pump Station Valve Identification System
09960	High Performance Ferrous Metal Coatings

R&R PACKAGE 1 PUMP STATION IMPROVEMENTS
University at Rouse PS #3365, Lena Street PS #3309, Allison Oaks PS #3893, Greenview
Pines PS #3887 and Bradford Cove PS #3890

TECHNICAL SPECIFICATIONS

Table of Contents

DIVISION 10 – SPECIALTIES (NOT USED)

DIVISION 11 – EQUIPMENT

11305 Submersible Pumps and Appurtenances
11305-A Submersible Pump Schedule

DIVISION 12 – FURNISHING (NOT USED)

DIVISION 13 – SPECIAL CONSTRUCTION

13423 Level Measurement
13430 Pump Station Control Panels

DIVISION 14 – CONVEYING EQUIPMENT (NOT USED)

DIVISION 15 – MECHANICAL

15062 Ductile Iron Pipe and Fittings
15064 Polyvinyl Chloride (PVC) Pipe and Fittings
15065 Stainless Steel Pipe and Fittings
15100 Ancillary Equipment
15105 Check Valves
15110 Plug Valves

DIVISION 16 – ELECTRICAL

16010 Electrical General Provisions
16110 Raceways
16120 Wires and Cables
16135 Electrical Boxes and Fittings
16142 Electrical Connections for Equipment
16143 Wiring Devices
16170 Circuit and Motor Disconnects
16180 Over Current Protective Devices
16190 Supporting Devices
16195 Electrical Identification
16420 Service Entrance
16450 Grounding

R&R PACKAGE 1 PUMP STATION IMPROVEMENTS
University at Rouse PS #3365, Lena Street PS #3309, Allison Oaks PS #3893, Greenview
Pines PS #3887 and Bradford Cove PS #3890

TECHNICAL SPECIFICATIONS

Table of Contents

APPENDICES

APPENDIX A	GEOTECHNICAL REPORT
Appendix A	Geotechnical Investigation Report prepared by Antillian Engineering Associates, Inc.
Appendix A	Groundwater Sampling and Laboratory Screening Results for Pump Station 3365 and 3309 by BFA, Inc.
APPENDIX B	FORMS
Appendix B	Digital Data Submission
Appendix B	Pressure Test
Appendix B	Pump Station Start-Up Report
APPENDIX C	PERMITS OBTAINED BY COUNTY
APPENDIX D	LIST OF APPROVED PRODUCTS
Appendix D	Orange County Utilities – List of Approved Products (February 11, 2011)
APPENDIX E	BOUNDARY SURVEYS
Appendix E	Boundary and Topographic Survey PS #3365
Appendix E	Boundary and Topographic Survey PS # 3309
Appendix E	Proposed Boundary and Easement Survey PS #3365
Appendix E	Proposed Boundary and Easement Survey PS #3309
APPENDIX G	DEWATERING DISCHARGE OFF-SITE
Appendix G	FDEP Notice of New Method for Mercury Testing
Appendix G	FDEP Generic Permit for the Discharge of Produced Groundwater
Appendix G	Memo – EPA – Analytical Methods for Mercury in NPDES Permits
Appendix G	Orange County EPD Work Instruction

**SECTION 01001
GENERAL WORK REQUIREMENTS**

TABLE OF CONTENTS

PART 1 - GENERAL	3
1.01 NOTICE AND SERVICE	3
1.02 WORK TO BE DONE	3
1.03 DRAWINGS AND PROJECT MANUAL.....	3
1.04 PROTECTION AND RESTORATION.....	5
1.05 PUBLIC NUISANCE.....	6
1.06 CONTRACTOR’S PAYMENTS TO COUNTY FOR OVERTIME WORK	6
1.07 MAINTENANCE OF SERVICE	7
1.08 TRANSFER OF SERVICE.....	7
1.09 LABOR.....	7
1.10 MATERIALS AND EQUIPMENT.....	8
1.11 MANUFACTURER'S SERVICE	9
1.12 INSPECTION AND TESTING.....	9
1.13 PROJECT SITE AND ACCESS	12
1.14 UTILITIES	12
1.15 RELATED CONSTRUCTION REQUIREMENTS	16
1.16 CONSTRUCTION NOT PERMITTED.....	21
PART 2 - PRODUCTS (NOT USED)	222221
PART 3 - EXECUTION (NOT USED).....	222221

SECTION 01001
GENERAL WORK REQUIREMENTS

TABLE OF CONTENTS

[THIS PAGE INTENTIONALLY LEFT BLANK](#)

← - - - Formatted: Centered

SECTION 01001
GENERAL WORK REQUIREMENTS

PART 1 - GENERAL

1.01 NOTICE AND SERVICE

- A. In conformance with the requirements of Notice and Service of the General Conditions, all notices or other papers required to be delivered by the Contractor to the County shall be delivered to the office of the Engineering Division, Orange County Utilities Department, 9150 Curry Ford Road, Orlando, FL 32825.

1.02 WORK TO BE DONE

- A. The Contractor shall furnish all labor, materials, equipment, tools services and incidentals to complete all work required by these specifications and as shown on the Drawings, at a rate of progress which will ensure completion of the Work within the Contract Time stipulated.
- B. All materials, equipment, skills, tools and labor which is reasonably and properly inferable and necessary for the proper completion of the Work in a substantial manner and in compliance with the requirements stated or implied by these Specifications or Drawings shall be furnished and installed by the Contractor without additional compensation, whether specifically indicated in the Contract Documents or not.
- C. The Contractor shall perform the Work complete, in place, and ready for continuous service, and shall include repairs, testing, permits, clean up, replacements, and restoration required as a result of damages caused during this construction.
- D. The Contractor shall comply with all City, County, State, Federal, and other codes, which are applicable to the proposed construction Work.
- E. All newly constructed Work shall be carefully protected from injury in any way. No wheeling, walking, or placing of heavy loads on it shall be allowed and all portions damaged shall be reconstructed by the Contractor at his own expense.
- F. Scope of Work: See Section 01010 "Summary of Work" and the Bid Schedule for details.

1.03 DRAWINGS AND PROJECT MANUAL

- A. The Work shall be performed in accordance with the Drawings and Specifications prepared by the County/Professional. All work and materials shall conform to the Orange County Utilities Standards and Construction Specifications Manual, latest edition or as indicated in these Specifications or Drawings.

- B. The Contractor shall verify all dimensions, quantities and details shown on the Drawings, Supplementary Drawings, Schedules, Specifications or other data received from the County/Professional, and shall notify same, in writing, of all errors, omissions, conflicts and discrepancies found therein. Failure to discover or correct errors, conflicts or discrepancies shall not relieve the Contractor of full responsibility for unsatisfactory Work, faulty construction or improper operation resulting there from, nor from rectifying such conditions at his own expense.
- C. All schedules are given for the convenience of the County and the Contractor and are not guaranteed to be complete. The Contractor shall assume all responsibility for the making of estimates of the size, kind, and quantity of materials and equipment included in the Work to be done under this Contract.
- D. Intent:
1. **All Work called for in the Specifications applicable to this Contract, but not shown on the Drawings in their present form, or vice versa, shall be of like effect as if shown or mentioned in both. Work not specified either in the Drawings or in the Specifications, but involved in carrying out their intent or in the complete and proper execution of the Work, is required and shall be performed by the Contractor as though it were specifically delineated or described.**
 2. **Items of material, equipment, machinery, and the like may be specified on the Drawings and not in the Specifications. Such items shall be provided by the Contractor in accordance with the specification on the Drawings.**
 3. **The apparent silence of the Specifications as to any detail, or the apparent omission from them of a detailed description concerning any Work to be done and materials to be furnished, shall be regarded as meaning that only the best general practice is to prevail and that only material and workmanship of the best quality is to be used, and interpretation of these Specifications shall be made upon that basis.**
- E. When obtaining data and information from the Drawings, conflicts, errors, and discrepancies shall be resolved from the documents given the following order of precedence:
1. **Agreement**
 2. **Change Orders**
 3. **Addenda**
 4. **Supplementary Conditions**
 5. **Instructions to Bidders**
 6. **General Conditions**
 7. **Specifications (Divisions. 1 through 16)**
 8. **Drawings**
 9. **Dimensions**
When measurements are affected by conditions already established or where items are to be fitted into constructed conditions, it shall be the Contractor's responsibility to verify all such dimensions at the site and the actual job dimensions shall take precedence over scale and figure dimensions on the Drawings.
 10. **Full-size Drawing**

11. **Large-scale Drawing**
12. **Small-scale Drawing**
13. **Advertisement for Bids**
14. **Bid**
15. **Bonds**
16. **Insurance Certificates**
17. **Insurance Endorsements**
18. **Affidavits**

1.04 PROTECTION AND RESTORATION

- A. The Contractor shall be responsible for the preservation of all public and private property, and shall use every means of protection necessary to prevent damage thereto. If any direct or indirect damage is done to public or private property by or on account of any act, omission, neglect, or misconduct in the execution of the Work on the part of the Contractor, such property shall be restored by the Contractor, at his expense, to a condition similar or equal to that existing before the damage was done, or he shall make good the damage in other manner acceptable to the County/Professional.
- B. Protection of Trees and Shrubs
 1. **Protect with boxes or other barricades.**
 2. **Do not place excavated material so as to injure trees or shrubs.**
 3. **Install pipelines in short tunnels between and under root systems.**
 4. **Support trees to prevent root disturbance during nearby excavation.**
- C. Tree and Limb Removal
 1. **Tree limbs, which interfere with equipment operation and are approved for pruning, shall be neatly trimmed and the tree cut coated with tree paint.**
 2. **The County may order the Contractor, for the convenience of the County, to remove trees along the line or trench excavation. The Contractor shall obtain any permits required for removal of trees. Ordered tree removal shall be paid for under the appropriate Contract Items.**
- D. Trees or shrubs destroyed by negligence of the Contractor or his employees shall be replaced by him with new stock of similar size and age, at the proper season and at the sole expense of the Contractor.
- E. Lawn Areas: All lawn areas disturbed by construction shall be replaced with like kind to a condition similar or equal to that existing before construction. Where sod is to be removed, it shall be carefully removed, and the same re-sodded, or the area where sod has been removed shall be restored with new sod in the manner described in the applicable section.
- F. Fences: Any fence, or part thereof, that is damaged or removed during the course of the Work shall be replaced or repaired by the Contractor, and shall be left in as good a condition as before the starting of the Work.

- G. Where fencing, walls, shrubbery, grass strips or area must be removed or destroyed incident to the construction operation, the Contractor shall, after completion of the Work, replace or restore to the original condition all such destroyed or damaged landscaping and improvements.
- H. The cost of all labor, materials, equipment, and work for restoration shall be deemed included in the appropriate Contract Item or items, or if no specific item is provided therefore, as part of the overhead cost of the Work, and no additional payment will be made therefore.

1.05 PUBLIC NUISANCE

- A. The Contractor shall not create a public nuisance including, but not limited to, encroachment on adjacent lands, flooding of adjacent lands, or excessive noise.
- B. Sound levels measured by the County/Professional shall not exceed 45 dBA from 8 p.m. to 8 a.m. or 55 dBA 8 a.m. to 8 p.m. This sound level shall be measured at the exterior of the nearest exterior wall of the nearest residence. Levels at the equipment shall not exceed 85 dBA at any time. Sound levels in excess of these values are sufficient cause to have the Work halted until equipment can be quieted to these levels. Work stoppage by the County/Professional for excessive noise shall not relieve the Contractor of the other portions of this specification including, but not limited to, completion dates and bid amounts.
- C. No extra charge may be made for time lost due to work stoppage resulting from the creation of a public nuisance.

1.06 CONTRACTOR'S PAYMENTS TO COUNTY FOR OVERTIME WORK

- A. County Inspector Work Hours: Normal work hours for the County's inspector(s) are defined as any 8-hour period between the hours of 7:00 a.m. and 7:00 p.m. on the weekdays of Monday through Friday. Any County Inspector(s) work beyond the aforementioned normal work hours shall be requested in writing 48-hours in advance. All overtime and weekend work compensation to the County's Inspector(s) for working beyond the normal working hours are considered overtime compensation and shall be paid for by the Contractor at the overtime pay rate of \$47.50 per hour. This overtime pay rate is subject to adjustment by the County. The Contractor agrees that the County shall deduct charges for work outside normal work hours and for overtime pay from payments due the Contractor.

1.07 MAINTENANCE OF SERVICE

- A. If this project includes the demolition, rehabilitation and replacement of facilities that transmit wastewater within a wastewater collection system; the collection and transmission of wastewater is a continuous operation and must remain in service at all times. Unless noted otherwise on the plans, the operation of the existing wastewater pumping facility on each of the respective locations shall remain in service until the transfer of service has been completed. See "Transfer of Service" for additional description of these requirements. In lieu of maintaining the existing pumping station, the Contractor may provide bypass pumping. Bypass pumping provided by the Contractor either as alternate to maintaining the existing pumping facility or as required when noted on the specific facility plan shall meet the requirements as noted in Section 01516 "Collection System Bypass."
- B. The Contractor shall, prior to interrupting any utility service (water, sewer, etc.) for the purpose of making cut-ins to the existing lines or for any other purposes, contact the County and make arrangements for the interruption which will be satisfactory to the County.
- C. Utility lines that are damaged during construction shall be repaired by the Contractor and service restored within 4-hours of the breakage. The County retains the option of repairing any damage to utility pipes in order to expedite service to the customers. The Contractor will remain responsible for all costs associated with the repair.

1.08 TRANSFER OF SERVICE

- A. The Contractor shall use temporary plugs in the existing and proposed sewer lines to control the routing of gravity flow to the active pumping facility during the transfer period. The proposed pumping facility shall be constructed while the existing or bypass facility is in operation. When the County has accepted the proposed facilities and placed the facility into operation, the transfer of service is complete. The Contractor may begin the work of removing the existing facility or bypass pumping equipment. The Contractor shall also install permanent plugs in the sewer pipes to allow abandonment or removal of the existing sewer system and pumping facilities as noted on the plans.

1.09 LABOR

- A. Supervision: The Contractor shall keep the Contract under his own control and it shall be his responsibility to see that the Work is properly supervised and carried on faithfully and efficiently. The Contractor shall supervise the Work personally or shall have a competent, English speaking superintendent or representative, who shall be on the site of the Project at all working hours, and who shall have full authority by the Contractor to direct the performance of the Work and make arrangements for all necessary materials, equipment, and labor without delay.

- B. Jurisdictional Disputes: It shall be the responsibility of the Contractor to pay all costs that may be required to perform any of the Work shown on the Drawings or specified herein to avoid any work stoppages due to jurisdictional disputes. The basis for subletting work in question, if any, shall conform to precedent agreements and decisions on record with the Building and Construction Trades Department, AFL-CIO, dated June, 1973, including any amendments thereto.
- C. Apprenticeship: The Contractor shall comply with all of the requirements of Section 446, Florida Statutes, for all contracts in excess of \$25,000 excluding roadway, highway or bridge contracts and the Contractor agrees to insert in any subcontract under this Contract the requirements of this Article.

1.10 MATERIALS AND EQUIPMENT

A. MANUFACTURER

1. **All transactions with the manufacturers or Subcontractors shall be through the Contractor, unless the Contractor shall request and at the County/Professional's option, that the manufacturer or Subcontractor communicate directly with the County/Professional. Any such transactions shall not in any way release the Contractor from his full responsibility under this Contract.**
2. **All workmanship and materials shall be of the highest quality. The equipment shall be the product of manufacturers who are experienced and skilled in the field with an established record of research and development. No equipment will be considered unless the manufacturer has designed and manufactured equipment of comparable type and size and have demonstrated sufficient experience in such design and manufacture.**
3. **All materials and equipment furnished by the Contractor shall be subject to the inspection, review and acceptance of the County and meet the requirements as outlined in the Orange County Utilities Standards and Construction Specifications Manual. No material shall be delivered to the Work without prior approval of the County/Professional.**
4. **All apparatus, mechanisms, equipment, machinery, and manufactured articles for incorporation into the Project shall be the new (most current production at time of bid) and unused standard products of recognized reputable manufacturers.**
5. **Manufactured and fabricated products:**
 - a. Design, fabricate and assemble in accord with the best engineering and shop practices.
 - b. Manufacture like parts of duplicate units to standard sizes and gauges, to be interchangeable.
 - c. Any two or more pieces of material or equipment of the same kind, type or classification, and being used for identical types of service, shall be made by the same manufacturer.
 - d. Products shall be suitable for service conditions as specified and as stated by manufacturer.
 - e. Equipment capacities, sizes and dimensions shown or specified shall be adhered to unless variations are specifically approved in writing.

- f. Do not use material or equipment for any purpose other than that for which it is designed or is specified.

1.11 MANUFACTURER'S SERVICE

- A. Where service by the manufacturer is specified to be furnished as part of the cost of the item of equipment, the Work shall be at the Contractor's expense.
- B. The services provided shall be by a qualified manufacturer's service representative to check and verify the completed installation, place the equipment in operation, and instruct the County's operators in the operation and maintenance procedures. Such services are to be for period of time and for the number of trips specified. A working day is defined as a normal 8-hour working day on the job and does not include travel time.
- C. The services shall further demonstrate to the County/Professional's complete satisfaction that the equipment will satisfactorily perform the functions for which it has been installed.

1.12 INSPECTION AND TESTING

- A. General
 - 1. **If, in the testing of any material or equipment, it is ascertained by the County/Professional that the material or equipment does not comply with the Contract, the Contractor shall be notified thereof, and he will be directed to refrain from delivering said material or equipment, or to remove it promptly from the site or from the Work and replace it with acceptable material, without cost to the County.**
 - 2. **Tests of electrical and mechanical equipment and appliances shall be conducted in accordance with recognized test codes of the ANSI, ASME, or the IEE, except as may otherwise be stated herein.**
- B. Cost
 - 1. **County shall employ and pay for the services of an independent testing laboratory to perform testing specifically indicated on the Contract Documents or specified in the Specifications and may at any other time elect to have materials and equipment tested for conformity with the Contract Documents.**
 - 2. **The cost of field leakage and pressure tests and shop tests of materials and equipment specifically called for in the Contract Documents shall be borne by the Contractor, and such costs shall be deemed to be included in the Contract price.**
 - 3. **Notify County employed laboratory a minimum of 48-hours, sufficiently in advance of operations to allow for laboratory assignment of personnel and scheduling of tests. When tests or inspections cannot be performed after such notice, reimburse County for laboratory personnel and travel expenses incurred.**
 - 4. **The Contractor shall pay for all work required to uncover, remove, replace, retest, etc., any work not tested due to the Contractor's failure to provide the 48-hours advance notice or due to failed tests. The Contractor shall also provide**

compensation for the County/Professional's personnel for required re-testing due to failed or rescheduled testing.

C. Shop Testing

- 1. Each piece of equipment for which pressure, duty, capacity, rating, efficiency, performance, function or special requirements are specified shall be tested in the shop of the manufacturer in a manner which shall conclusively prove that its characteristics comply fully with the requirements of the Contract Documents. No such equipment shall be shipped to the worksite until the County/Professional notifies the Contractor, in writing, that the results of such tests are acceptable.**
- 2. Five (5) copies of the manufacturer's actual shop test data and interpreted results thereof, accompanied by a certificate of authenticity notarized and signed by a responsible official of the manufacturing company, shall be furnished to the County/Professional as a prerequisite for the acceptance of any equipment. The cost of shop tests (excluding cost of County's representative) and of furnishing manufacturer's preliminary and shop test data of operating equipment shall be borne by the Contractor and shall be included in the Contract price.**
- 3. The Contractor shall give notice in writing to the County sufficiently in advance of his intention to commence the manufacture or preparation of materials especially manufactured or prepared for use in or as part of the permanent construction. Such notice shall contain a request for inspection, the date of commencement and the expected date of completion of the manufacture or preparation of materials. Upon receipt of such notice, the County shall arrange to have a representative present at such times during the manufacture as may be necessary to inspect the materials; or he will notify the Contractor that the inspection will be made at a point other than the point of manufacture; or he will notify the Contractor that inspection will be waived.**
- 4. When inspection is waived or when the County/Professional so requires, the Contractor shall furnish to him authoritative evidence in the form of Certificates of Manufacture that the materials to be used in the Work have been manufactured and tested in conformity with the Contract Documents. These certificates shall be notarized and shall include five (5) copies of the results of physical tests and chemical analysis, where necessary, that have been made directly on the product or on similar products of the manufacturer.**
- 5. The Contractor must comply with these provisions before shipping any material. Such inspections by the County shall not release the Contractor from the responsibility for furnishing materials meeting the requirements of the Contract Documents.**

D. Field Testing:

- 1. The County shall employ and pay for services of an independent testing laboratory to perform testing specifically indicated in the Contract Documents. Employment of the laboratory shall in no way relieve Contractor's obligations to perform the Work of the Contract. The Contractor shall provide compensation for retesting of all failed tests.**
- 2. The County may at any time during the progress of the Work, request**

additional testing beyond that which is specified in the Contract. This testing will be at the County's expense. The Contractor shall assist the testing laboratory personnel in all ways so as to facilitate access to the location of the material or equipment to be tested. Contractor shall:

- a. Cooperate with laboratory personnel, provide access to the Project.
 - b. Secure and deliver to the laboratory adequate quantities of representative samples of materials proposed to be used and which require testing.
 - c. Provide to the laboratory the preliminary design mix proposed to be used for concrete, and other material mixes, which require control by the testing laboratory.
- 3. The following schedule summarizes the responsibilities of various tests that may be required by the Contract Documents. Contractor shall notify the County in advance of work so that arrangements can be made with the testing laboratory.**

TEST	NOTES	PAID FOR
Soil Compaction	A. Pipe Work: Every 300 ft. at each lift of compaction B. Structures: As a minimum one test per 2000 SF of fill area per lift, or at least 2 tests per structure, per lift. As specified in material specifications sections	County
Low Pressure Air Exfiltration	Each section of gravity sewer pipe between manholes or lift station	Contractor
Hydrostatic Pressure	All segments of pressure piping (24-hour test).	Contractor
Hydrostatic Leakage	All segments of pressure piping (2-hour test).	Contractor
Bacteriological	As required by local and state agencies	County
Asphaltic Concrete Paving	As required by County	County
LBR	Each 600 SY of pavement	County
Concrete	Slump test each delivery, cylinders every 20 CY	County
Asbestos	Environmental testing of materials	County
All Other Testing	As specified in various sections of the Project Manual	As Indicated

- E. Demonstration Tests: Upon completion of the Work and prior to final payment, all equipment and piping installed under this Contract shall be subjected to acceptance or demonstration tests as specified or required to provide compliance with the Contract Documents. The Contractor shall furnish all labor, fuel, energy, water and all other equipment necessary for the demonstration tests at no additional cost to the County.
- F. Final Inspection: Prior to preparation of the final payment application, a final inspection will be performed by the County to determine if the Work is properly and satisfactorily constructed in accordance with the requirements of the Contract Documents. See also Section 01700 "Project Closeout."
- G. Inspection by existing utility owners: The Contractor shall pay for all inspections during the progress of the Work required and provided by the owner of all existing public utilities paralleling or crossing the Work, as shown on the Drawings. All such inspection fees shall be deemed included in the appropriate Contract Item or items, or if no specific item is provided therefore, as part of the overhead cost of the Work, and no additional payment will be made therefore.

H. Inspection by Other Agencies: The Florida Department of Transportation, the Florida Department of Environmental Protection, and other authorized governmental agencies shall have free access to the site for inspecting materials and work, and the Contractor shall afford them all necessary facilities and assistance for doing so. Any instructions to the Contractor resulting from these inspections shall be given through the County. These rights of inspections shall not be construed to create any contractual relationship between the Contractor and these agencies.

1.13 PROJECT SITE AND ACCESS

A. RIGHT-OF-WAY AND EASEMENTS

1. **The use of public streets and alleys shall be such as to provide a minimum of inconvenience to the public and to other traffic. Any earth or other excavated material spilled from trucks shall be removed by the Contractor and the streets cleaned to the satisfaction of the County.**
2. **The Contractor shall not enter or occupy private land outside of easements, except by written permission of the property owner.**
3. **At the time of the Pre-Construction meetings, the Contractor shall fully acquaint himself with the status of all easements required for the Work and the possibility of parcels remaining to be acquired, if any. Should easements not be acquired by the County in specific areas of the Work, the Contractor shall sequence and reschedule his work therein so as not to interfere with the progress of work in other areas of the Project. Such rescheduling of work shall be performed by the Contractor at no additional cost to the County. The County agrees that it will make every effort to acquire all remaining easements with all speed and diligence possible so as to allow the completion of the Work within the Contract time.**

B. ACCESS

1. **Neither the material excavated nor the materials or equipment used in the construction of the Work shall be so placed as to prevent free access to all fire hydrants, valves or manholes.**
2. **Access to businesses located adjacent to the project site must be maintained at all times. Contractor may prearrange the closing of business access with the business Owner. Such prearranged access closing shall not exceed two (2) hours. Property drainage and grading shall be restored and all construction debris removed within 48-hours of backfilling trench.**
3. **Contractor agrees that representatives of the County and any governmental agents will have access to the Work wherever it is in preparation or progress and that the Contractor shall provide facilities for such access and inspection.**

1.14 UTILITIES

A. UTILITY CONSTRUCTION

1. **Public utility installations and structures shall be understood to include all poles, tracks, pipes, wires, conduits, house service connections, vaults, manholes and all other appurtenances and facilities pertaining thereto, whether owned or**

controlled by governmental bodies or privately owned by individuals, firms or corporations, used to serve the public with transportation, traffic control, gas, electricity, telephone, sewerage, drainage or water. Other public or private property, which may be affected by the Work, shall be deemed included hereunder.

2. **All open excavations shall be adequately safeguarded by providing temporary barricades, caution signs, lights and other means to prevent accidents to persons, and damage to property. The Contractor shall, at his own expense, provide suitable and safe bridges and other crossings for accommodating travel by pedestrians and workmen. Bridges provided for access to private property during construction shall be removed when no longer required.**
3. **The length of open trench will be controlled by the particular surrounding conditions, but shall always be confined to the limits described by the County. If any excavation becomes a hazard, or if it excessively restricts traffic at any point, the County may require special construction procedures. As a minimum, the Contractor shall conform to the following restoration procedures:**
 - a. **Interim Restoration:** All excavations shall be backfilled and compacted as specified by the end of each working day. For excavations within existing paved areas; limerock base or soil cement base (match existing) shall be spread and compacted to provide a relatively smooth surface free of loose aggregate material. At the end of each workweek, the S-I asphaltic surface course shall be completed and opened to traffic. Contractor shall coordinate his construction activity including density tests and inspections to allow sufficient time to achieve this requirement. All driveway cuts shall be backfilled, compacted, and limerock base spread and compacted immediately after installation. Contractor shall coordinate with the individual property owners prior to removing the driveway section. Any utility crossing an existing roadway, parking lot or other paved area shall be patched by the end of the working day.
 - b. All pipe and fittings shall be neatly stored in a location, which will cause the least disturbance to the public. All debris shall be removed and properly disposed of by the end of each working day.
 - c. **Final Restoration Overlay:** After completing all installations, and after testing of the pipe (but no sooner than 30-days after applying the S-I asphaltic surface), final restoration shall be performed. In no event shall final restoration begin after substantial completion. Final restoration shall provide an S-III asphaltic overlay as specified in an uninterrupted continuous operation until completion. Any additional restoration required after testing shall be repaired in a timely manner at no additional cost to the County.
 - d. Maintenance of all restored facilities shall be the Contractor's responsibility. This maintenance shall be performed on an on-going basis during the course of construction. The Contractor's Progress Schedule shall reflect the above restoration requirements.
 - e. **Additional Restoration for Work in Business or Commercial Districts:** The Contractor shall restore all private property, damaged by construction, to its original condition. Access to businesses located adjacent to the project site must be maintained at all times. Contractor may prearrange the closing of business accesses with the business owner. Such prearranged access closing shall not

exceed two (2) hours. Property drainage and grading shall be restored within 24-hours of backfilling trench.

B. EXISTING UTILITIES

1. **The locations of all existing underground piping, structures and utilities have been taken from information received from the respective owner. The locations are shown without express or implied representation, assurance, or guarantee that they are complete or correct or that they represent a true picture of underground piping, conduit and cables to be encountered. It is the Contractor's responsibility to verify all depths of marked locates as well as underground structures.**
2. **The Contractor shall, at all times in performance of the Work, employ acceptable methods and exercise reasonable care and skill so as to avoid unnecessary delay, injury, damage or destruction of existing public utility installations and structures; and shall, at all times in the performance of the Work, avoid unnecessary interference with, or interruption of, public utility services; and shall cooperate fully with the owners thereof to that end.**
3. **Pipelines shall be located substantially as indicated on the Drawings, but the County reserves the right to make such modifications in locations as may be found desirable to avoid interference with existing structures or for other reasons. When the location of piping is dimensioned on the Drawings, it shall be installed in that location; when the location of piping is shown on a scaled drawing, without dimensions, the piping shall be installed in the scaled location unless the County approves an alternate location for the piping. Where fittings are noted on the Drawings, such notation is for the Contractor's convenience and does not relieve him from laying and jointing different or additional items where required. The County/Professional may require detailed pipe laying drawings and schedules for project control.**
4. **The Contractor shall exercise care in any excavation to locate all existing piping and utilities. All utilities, which do not interfere with the completed work, shall be carefully protected against damage. Any existing utilities damaged in any way by the Contractor shall be restored or replaced by the Contractor at his expense as directed by the County. Any existing facilities, which require operation to facilitate repairs, shall be operated only by the owner of the respective utility.**
5. **It is the responsibility of the Contractor to ensure that all utility or other poles, the stability of which may be endangered by the proximity of excavation, be temporarily stayed and/or shored in position while work proceeds in the vicinity of the pole and that the utility or other companies concerned be given reasonable advance notice of any such excavation by the Contractor.**

C. NOTICES

1. **All governmental utility departments and other owners of public utilities, which may be affected by the Work, will be informed in writing by the Contractor two (2) weeks after the execution of the Contract or Contracts covering the Work. Such notice will be sent out in general, and directed to the attention of the governmental utility departments and other owners of public utilities for such installations and structures as may be affected by the Work.**

2. **The Contractor shall also comply with Florida Statute 553.851 regarding notification of existing gas and oil pipeline company owners. Evidence of such notice shall be furnished to the County within two (2) weeks after the execution of the Contract.**
3. **It shall be the Contractor's responsibility to contact utility companies at least 72-hours in advance of breaking ground in any area or on any unit of the Work so maintenance personnel can locate and protect facilities, if required by the utility company.**
4. **The Contractor shall give a minimum five (5) working day notice prior to utility personnel interrupting a utility service (water, sewer, etc.) for the purpose of making cut-ins to the existing lines or for any other purposes, contact the utility owner and make arrangements for the utility personnel to isolate the existing lines thus providing interruption which will be satisfactory to the utility owner.**

D. EXPLORATORY EXCAVATIONS

1. **Exploratory excavations shall be conducted by the Contractor for the purpose of locating underground pipelines or structures in advance of the construction. Test pits shall be excavated in areas of potential conflicts between existing and proposed facilities and at piping connections to existing facilities a minimum of 48-hours or 1,000-feet in advance of work. If there is a potential conflict, the Contractor is to notify the County/Professional immediately. Information on the obstruction to be furnished by the Contractor shall include: Location, Elevation, Utility Type, Material and Size. Test pits shall be backfilled immediately after their purpose has been satisfied and the surface restored and maintained in a manner satisfactory to the County.**

E. UTILITY CROSSINGS

1. **It is intended that wherever existing utilities must be crossed, deflection of the pipe within specified limits and cover shall be used to satisfactorily clear the obstruction unless otherwise indicated on the Drawings. However, when in the opinion of the County this procedure is not feasible, he may direct the use of fittings for a utility crossing or conflict transition as detailed on the Drawings.**

F. RELOCATIONS

1. **Relocations shown on the Drawings: Public utility installations or structures, including but not limited to light poles, signs, fences, piping, conduits and drains that interfere with the positioning of the Work which are shown on the Drawings to be removed, relocated, replaced or rebuilt by the Contractor shall be considered as part of the general cost of doing the Work and shall be included in the prices bid for the various contract items. No separate payment shall be made therefore.**
2. **Relocations not shown on the Drawings**
 - a. **Where public utility installations or structures are encountered during the course of the Work, and are not indicated on the Drawings or in the Specifications, and when, in the opinion of the County, removal, relocation, replacement or rebuilding is necessary to complete the Work under this contract, such work shall**

be accomplished by the utility having jurisdiction, or such work may be ordered, in writing by the County, for the Contractor to accomplish.

- b. If such work is accomplished by the utility having jurisdiction, it will be carried out expeditiously and the Contractor shall give full cooperation to permit the utility to complete the removal, relocation, replacement or rebuilding as required. If such work is accomplished by the Contractor, it will be paid for as a Change Order.
3. **All existing castings, including valve boxes, junction boxes, manholes, hand holes, pull boxes, inlets and similar structures in the areas of construction that are to remain in service and in areas of trench restoration and pavement replacement, shall be adjusted by the Contractor to bring them flush with the surface of the finished work.**
4. **All existing utility systems which conflict with the construction of the Work herein, which can be temporarily removed and replaced, shall be accomplished at the expense of the Contractor. Work shall be done by the utility unless the utility approves in writing that the Work may be done by the Contractor.**

1.15 RELATED CONSTRUCTION REQUIREMENTS

A. PUBLIC INFORMATION OFFICER

1. The Contractor shall provide community interaction and coordination through a designated Public Information Officer (PIO). The PIO will provide complaint and problem resolutions for community members affected by the construction for the entire project duration. The PIO will manage a 24 hour hotline phone number for citizens to call regarding questions or problems they may experience with respect to the construction activities. The PIO will field these calls, provide answers to questions, research issues with the project team or appropriate agencies and follow up each complaint in a timely manner. The PIO will maintain a daily diary of call and/or interactions with the community, as well as a complaint log chronicling all issues and proposed resolutions.
2. The PIO will attend the monthly project progress meetings and provide the project team with a report of public issues for the previous month. The PIO will also disseminate roadway closures, sewer hookups, temporary and permanent restoration and other relevant construction information to the community, as well as, when appropriate, to the media, emergency services personnel and other interested agencies.
3. The designated PIO shall have previous experience in providing similar services on Orange County Utilities, Orange County Public Works or FDOT construction projects. The PIO shall be bi-lingual (English and Hispanic) and physically capable of visitation to the construction site, meeting locations and affected resident's homes without special assistance.

B. TRAFFIC MAINTENANCE

1. **Maintain public highway traffic within the limits of the Project for the duration of the construction period, including any temporary suspensions of Work. Work shall also include construction and maintenance of any necessary detour facilities; furnishing, installing and maintaining of traffic control and safety**

- devices during construction, control of dust, or any other special requirements for safe and expeditious movement of vehicular and pedestrian traffic.
2. **Traffic Control shall be provided at the Contractor's expense by the Contractor's personnel or off-duty uniformed police officer, depending on and as required by the applicable traffic control requirements jurisdictional to the construction or road.**
 3. **The Contractor shall prepare and submit a Maintenance of Traffic plan (MOT) to the County/Professional and to the County Public Works Department for review and acceptance prior to commencing any Work on the site. The Traffic Control Plan shall detail procedures and protective measures proposed by the Contractor to provide for protection and control of traffic affected by the Work consistent with the following applicable standards:**
 - a. Standard Specifications for Road and Bridge Construction, Latest Edition including all subsequent supplements issued by the Florida Department of Transportation, (FDOT Spec.).
 - b. Manual of Traffic Control and Safe Practices for Street and Highway Construction, Maintenance and Utility Operations, FDOT.
 - c. Right-of-Way Utilization Regulations, Orange County, Florida, latest edition. All references to the respective agency in the above referenced standards shall be construed to also include the County for this Work.
 - d. The cost of any required road permits shall be borne by the Contractor.
 - e. The Contractor will notify the public one (1) week in advance of any scheduled work via the use of portable message boards. The message boards shall be located at each approach to the construction area.
 4. **Before closing any thoroughfare, the Contractor shall give written notice to, and if necessary, obtain a permit or permits from the duly constituted public authority having jurisdiction over the thoroughfare. Notice shall be given no less than 72-hours in advance of the time when it may be necessary in the process of construction to close such thoroughfare, or as may be otherwise provided in the acceptable Maintenance of Traffic plan (MOT).**
 5. **The Contractor shall sequence and plan construction operations and shall generally conduct his work in such a manner as not to unduly or unnecessarily restrict or impede existing normal traffic through the streets of the local community.**
 6. **Insofar as it is practicable, excavated material and spoil banks shall not be located in such a manner as to obstruct traffic. The traveled way of all streets, roads and alleys shall be kept clear and unobstructed insofar as is possible and shall not be used for the storage of construction materials, equipment, supplies, or excavated earth, except when and where necessary.**
 7. **If required by duly constituted public authority, the Contractor shall, at his own expense, construct bridges or other temporary crossing structures over trenches so as not to unduly restrict traffic. Such structures shall be of adequate strength and proper construction and shall be maintained by the Contractor in such a manner as not to constitute an undue traffic hazard. Private driveways shall not be closed except when and where necessary, and then only upon due advance notice to the County and for the shortest practicable period of time consistent with efficient and expeditious construction. The Contractor shall be liable for**

- any damages to persons or property resulting from his work.
8. **The Contractor shall make provisions at all "open cut" street crossings to allow a minimum of one lane to be open for vehicular traffic at all times. Lane closing shall be as permitted by the local governing authority and shall be repaired to a smooth, safe driving surface immediately following the installation of pipe or conduit. Flagmen shall be required, in addition to barricades, signs and other protective devices at all lane closings.**
 9. **The Contractor shall make provisions at cross streets for the free passage of vehicles and pedestrians, either by bridging or otherwise, and shall not obstruct the sidewalks, gutters, or streets, nor prevent in any manner the flow of water in the latter, but shall use all proper and necessary means to permit the free passage of surface water along the gutters.**
 10. **The Contractor shall immediately cart away all offensive matter; exercising such precaution as may be directed by the County. All material excavated shall be so disposed of as to inconvenience the public and adjacent tenants as little as possible and to prevent injury to trees, sidewalks, fences and adjacent property of all kinds.**

C. BARRIER AND LIGHTS

1. **The Contractor shall exercise extreme care in the conduct of the Work to protect health and safety of the workmen and the public. The Contractor shall provide all protective measures and devices necessary, in conformance with applicable local, state and federal regulations regarding their need and use. Protective measures shall include but are not limited to barricades, warning lights/flashers and safety ropes.**
2. **All equipment and vehicles operating within 10-feet of the roadway shall have flashing strobe lights attached.**

D. DEWATERING AND FLOTATION

1. **The Contractor, with his own equipment, shall do all pumping necessary to dewater any part of the Work area during construction operations to insure dry working conditions. The Contractor shall be completely responsible for any tanks, wetwells or similar structures that may become buoyant during the construction and modification operations due to the ground water or floods and before the structure is put into operation. The proposed final structures have been designed against buoyancy; however the Contractor may employ methods, means and techniques during the various stages of construction (or other conditions), which may affect the buoyancy of structures. Should there be any possibility of buoyancy of a structure; the Contractor shall take the necessary steps to prevent its buoyancy either by increasing the structure's weight, by filling it with approved material or other acceptable methods. Damage to any structures due to floating or flooding shall be repaired or the structures replaced at the Contractor's expense.**
2. **Contractor shall be responsible for any required permits for the discharge of ground water.**

E. DUST AND EROSION CONTROL

1. **The Contractor shall prevent dust nuisance from his operations or from traffic by the use of water and deliquescent salts.**
2. **Erosion and Sedimentation Control**
 - a. Temporary erosion controls include, but are not limited to, grassing, mulching, netting, watering and reseeded on-site surfaces and soil and borrow area surfaces and providing interceptor ditches at ends of berms and at those locations which will ensure that erosion during construction will be either eliminated or maintained within acceptable limits as established by the County, FDEP and any other agency having jurisdiction.
 - b. Temporary sedimentation controls include, but are not limited to; silt dams, traps, barriers, and appurtenances at the foot of sloped surfaces which will ensure that sedimentation pollution will be either eliminated or maintained within acceptable limits as established by the County, FDEP and any other agency having jurisdiction.
 - c. The construction of temporary erosion and sedimentation control facilities shall be in accordance with the technical provision of section 104-6.4 of the 1991 Edition, FDOT Standard Specifications for Road and Bridge Construction.
 - d. Contractor is responsible for providing effective temporary erosion and sediment control measures during construction or until final controls become effective.

F. **LINES AND GRADES**

1. **All Work under this Contract shall be constructed in accordance with the lines and grades shown on the Drawings, or as given by the County/Professional. The full responsibility for keeping alignment and grade shall rest upon the Contractor.**
2. **The Contractor shall, at his own expense, establish all working or construction lines and grades as required from the project control points set by the County, and shall be solely responsible for the accuracy thereof.**
3. **Water main and forcemain shall have a minimum of 36-inches of cover over the top of the pipe. Cover shall vary to provide long uniform gradient or slope to pipe to minimize air pockets and air release valves. The stationing shown on the Drawings for air and vacuum release valve assemblies are approximate and the Contractor shall field adjust these locations to locate these valves at the highest point in the pipeline installed. All locations must be acceptable by the County.**
4. **To insure a uniform gradient for gravity pipe and pressure pipe, all lines shall be installed using the following control techniques as a minimum:**
 - a. Gravity lines; continuous control, using laser beam technology.
 - b. Pressure lines; control stakes set at 50-foot intervals using surveyors' level instrument.

G. **CUTTING AND PATCHING**

1. **The Contractor shall do all cutting, fitting or patching of his portion of the Work that may be required to make the several parts thereof join and coordinate in a manner satisfactory to the County and in accordance with the Drawings and Specifications.**
2. **Preparation:**

- a. Inspect the existing conditions of the Project, including elements subject to damage and/or movement during cutting and patching.
 - b. Provide adequate temporary support to assure the structural integrity of all facilities during completion of the Work.
3. **Performance:**
- a. Execute cutting and demolition by methods, which will prevent damage to other existing facilities and will provide proper surfaces to receive installation of equipment and repair.
 - b. Excavation and backfilling shall be performed in a manner, which will prevent settlement and/or damage to existing facilities.
 - c. All pipes, sleeves, ducts, conduits and other penetration through surfaces shall be made airtight.
 - d. Refinish entire surfaces as necessary to provide an even finish to match adjacent finishes.

H. TEMPORARY CONSTRUCTION

- 1. **Temporary fences: If, during the course of the Work, it is necessary to remove or disturb any fencing, the Contractor shall at his own expense, provide a suitable temporary fence which shall be maintained until the permanent fence is replaced. The County/Professional will be solely responsible for the determination of the necessity for providing a temporary fence and the type of temporary fence to be used.**
- 2. **Responsibility for Temporary Structures: In accepting the Contract, the Contractor assumes full responsibility for the sufficiency and safety of all temporary structures or work and for any damage which may result from their failure or their improper construction, maintenance or operation and will indemnify and save harmless the County from all claims, suits or actions and damages or costs of every description arising by reason of failure to comply with the above provisions.**

I. DAILY REPORTS

- 1. **The Contractor shall submit to the County's Representative daily reports of construction activities including non-work days. The reports shall be complete in detail and shall include the following information:**
 - a. Days from Notice to Proceed; Days remaining to substantial and final completion.
 - b. Weather information
 - c. Work activities with reference to the Critical Path Method (CPM) schedule activity numbers (including manpower, equipment and daily production quantities for each individual activity).
 - d. Major deliveries
 - e. Visitors to site
 - f. Test records
 - g. New problems, and
 - h. Other pertinent information
- 2. **A similar report shall be submitted for/by each Subcontractor.**
- 3. **The report(s) shall be submitted to the County Representative's Field Office within 2 days of the respective report date. Each report shall be signed by the**

Contractor's Superintendent or Project Manager. Pay request will not be processed unless daily reports are current.

4. **If a report is incomplete, in error, or contains misinformation, a copy of the report shall be returned by the County Representative to the Contractor's Superintendent or Project Manager with corrections noted. When chronic errors or omissions occur, the Contractor shall correct the procedures by which the reports are produced.**

J. CLEANING

1. **During Construction**

- a. During construction of the Work, the Contractor shall, at all times, keep the site of the Work and adjacent premises as free from material, debris and rubbish as is practicable and shall remove the same from any portion of the site if, in the opinion of the County, such material, debris, or rubbish constitutes a nuisance or is objectionable.
- b. Provide on-site containers for the collection of waste materials, debris and rubbish and remove such from the site periodically by disposal at a legal disposal area away from the site.
- c. Clean interior spaces prior to the start of finish painting and continue cleaning on an as-needed basis until painting is finished. Use only those cleaning materials which will not create hazards to health or property and which will not damage surfaces. Use only those cleaning materials and methods recommended by the manufacturer of the surface material to be cleaned. Schedule operations so that dust and other contaminants resulting from cleaning process will not fall on wet or newly coated surfaces.
- d. The Contractor shall remove from the site all surplus materials and temporary structures when no longer necessary to the Work at the direction of the County.

2. **Final Cleaning**

- a. At the conclusion of the Work, all equipment, tools, temporary structures and materials belonging to the Contractor shall be promptly taken away, and he shall remove and promptly dispose of all water, dirt, rubbish or any other foreign substances. Employ skilled workmen for final cleaning. Thoroughly clean all installed equipment and materials to a bright, clean, polished and new appearing condition. Remove grease, mastic, adhesives, dust, dirt, stains, fingerprints, labels, and other foreign materials from sight-exposed interior and exterior surfaces. Broom clean exterior paved surfaces; rake clean other surfaces of the grounds.
- b. The Work shall be left in a condition as shown on the Drawings and the remainder of the site shall be restored to a condition equal or better than what existed before the Work.
- c. Prior to final completion, or County occupancy, Contractor shall conduct an inspection of interior and exterior surfaces, and all work areas to verify that the entire Work is clean. The County will determine if the final cleaning is acceptable.

1.16 CONSTRUCTION NOT PERMITTED

A. USE OF EXPLOSIVES

- 1. No blasting shall be done except upon approval by the County and the governmental agency or political subdivision having jurisdiction. When the use of explosives is approved by the County as necessary for the execution of the Work, the Contractor shall use the utmost care so as not to endanger life or property, and assume responsibility for any such damage resulting from his blasting operations, and whenever directed, the number and size of the charges shall be reduced. All explosives shall be stored in a secure manner and all such storage places shall be marked clearly, "DANGEROUS EXPLOSIVES" and shall be in care of competent watchmen. All permits required for the use of explosives shall be obtained by the Contractor at his expense. All requirements of the governmental agency issuing permit shall be observed.**

PART 2 - PRODUCTS (NOT USED)

PART 3 - EXECUTION (NOT USED)

END OF SECTION

SECTION 01010
SUMMARY OF WORK

PART 1 - GENERAL

1.01 WORK COVERED BY CONTRACT DOCUMENTS

A. This Contract is for the rehabilitation of three (3) existing pump stations and the construction of two (2) new pump stations (including the subsequent demolition of the existing two (2) pump stations they are replacing), which includes furnishing all labor, equipment, and materials for the construction of the facilities consisting of, but not limited to the expansion of or improvements to the equipment and structures associated with the following:

1. Pump Station 3309 – Lena Street

Installation of a new protective liner within the existing wet well.

Installation of two (2) new wastewater submersible pumps.

Installation of a new wet well top slab with access hatch and vent, power cable, steel cable, float liquid level control sensors, discharge pipes and fittings.

Installation of a new valve vault top slab with access hatch and coating the interior of the valve vault.

Installation of new valve vault valves, piping and appurtenances.

Installation of an above ground emergency pump out connection and segment of force main.

Removal and replacement of electrical system including electrical service, a new control panel and reinstallation of the existing SCADA system.

Installation of 1-inch water service line, reduced pressure back flow preventer and hose bibb.

Installation of a concrete driveway and concrete pump station pad.

Installation of a concrete pump station curbing.

Installation of 4-inch FDOT #57 stone over 60-mil geofabric weed control liner on all unpaved exposed area within pump station curbing.

De-scale and CIPP line a segment of existing D.I. influent gravity sanitary sewer.

2. Pump Station 3365 – University at Rouse

Remove the existing wet well liner and install a new extended protective liner within the existing wet well.

Remove the existing valve vault, meter vault and associated fittings, valves and piping.

Raise and grade the pump station site and the adjacent ground to the elevations shown on the Drawings.

Raise the top elevation of the existing sanitary manhole to the elevation shown on the Drawings and coat the interior of the manhole.

Installation of two (2) new wastewater submersible pumps.

Installation a cast-in-place concrete riser and a new wet well top slab with liner, access hatch, above grade piping outlets, vent, power cable, steel cable, float liquid level control sensors, discharge pipes and fittings.

Installation of above grade discharge piping, concrete slab with pipe supports, piping, valves and appurtenances.

Installation of a 12-inch by 8-inch tapping sleeve and valve, above ground emergency pump out connection and segment of 8-inch force main.

Removal and replacement of electrical system including electrical service, a new control panel and reinstallation of the existing SCADA system.

Installation of a water meter, 1-inch water service line, reduced pressure back flow preventer and hose bibb.

Installation of concrete driveways, sidewalk, curb and gutter, and concrete pump station pad.

Installation of concrete pump station curbing.

Installation of black vinyl coated chain link fence inside concrete curbing with 4 inch reveal all around and double swing gate.

Installation of 4-inch FDOT #57 stone over 60-mil geofabric weed control liner on all unpaved exposed area within pump station curbing.

Installation of chain link fencing in areas outside the pump station site including a double swing gate at the storm water pond entrance driveway

Place the existing 8-inch force main out of service by grout filling and removing the 16-inch aerial crossing over the Little Econ. River.

De-scale and CIPP line two segments of existing D.I. influent gravity sanitary sewer.

3. **Pump Station 3887 – Greenview Pines**

Installation of a new six (6) foot diameter HDPE lined wet well.

Installation of two (2) new wastewater submersible pumps.

Installation of access hatch, power cable, steel cable, float liquid level control sensors, discharge pipes and fittings and wet well ventilation system.

Installation of an underground valve vault with above ground emergency pump out system.

Removal and replacement of electrical system including a new control panel.

Installation of approximately 10 lineal feet of 4-inch PVC forcemain.

Installation of 1-inch water service with reduced pressure back flow preventer.

Installation of a 14 foot driveway.

Installation of ± 73 lineal feet of 6 foot black vinyl coated chain link fence along the new concrete driveway.

Installation of ± 103 lineal feet of 6 foot black vinyl coated chain link fence inside concrete curb with 4 inch reveal all around and one (1) 14 foot wide double 7 foot panels swing gate.

Installation of 4-inch FDOT #57 stone over 60-mil geofabric weed control liner on all unpaved exposed area within pump station fence.

Rehabilitation of two (2) existing manholes.

Demolish existing pump station.

4. **Pump Station 3890 -Bradford Cove**

Clean and rehabilitate existing wet well with new elevation, protective liner and concrete top.

Installation of two (2) new wastewater submersible pumps.

Installation of access hatch, power cable, steel cable, float liquid level control sensors, discharge pipes and fittings and wet well ventilation system.

Installation of a new above ground valves with emergency pump out system.

Removal and replacement of electrical system including a new control panel.

Installation of approximately thirty (30) lineal feet of 4-inch PVC forcemain.

Installation of 1-inch water service with reduced pressure back flow preventer.

Installation of a 14 foot driveway.

Removal of 132 lineal feet of chain link fence with curb and one (1) 14 foot gate.

Installation of \pm 160 lineal feet of 6 foot black vinyl coated chain link fence inside concrete curb with 4 inch reveal all around and one (1) 14 foot wide double 7 foot panels swing gate.

Installation of 4-inch FDOT #57 stone over 60-mil geofabric weed control liner on all unpaved exposed area within pump station fence.

Rehabilitate one (1) existing manhole.

Demolish existing valve vault.

Raise and grade the site to elevations shown on the Drawings.

Grading of site to provide positive drainage as shown on the Drawings.

5. Pump Station 3893A – Allison Oaks (replacement for PS 3893)

Installation of a new six (6) foot diameter HDPE lined wet well.

Installation of two (2) new wastewater submersible pumps.

Installation of access hatch, power cable, steel cable, float liquid level control sensors, discharge pipes and fittings and wet well ventilation system.

Installation of an underground valve vault with above ground emergency pump out system.

Removal and replacement of electrical system including a new control panel.

Installation of approximately \pm 90 lineal feet of 4-inch PVC forcemain.

Installation of six (6) new manholes

Installation of approximately \pm 302 lineal feet of 8-inch PVC gravity main.

Installation of a two service lateral.

Installation of 1-inch water service with reduced pressure back flow preventer.

Installation of a 16 foot driveway.

Removal and installation of \pm 107 lineal feet of chain link fence.

Installation of 4-inch FDOT #57 stone over 60-mil geofabric weed control liner on all unpaved exposed area within pump station fence.

Rehabilitate two (2) existing manholes.

Clean, grout and plug approximately 293 lineal feet of existing 8-inch gravity main.

Clean, grout and plug approximately 120 lineal feet of existing 4-inch forcemain.

Demolition of one (1) existing manhole.

Demolish existing pump station

Pavement restoration

1.02 WORKING HOURS

- A. Working hours for the County Inspector are an 8-hour period between the hours of 7:00 a.m. and 4:00 p.m., Monday through Friday. Any work beyond the 8-hour period is to be requested in writing 48 hours prior and paid for by the Contractor. Any work required on Saturday, Sunday or Holidays shall be requested in writing 48 hours in advance. All requests must be submitted to the County and approved by the County in advance. Under emergency situations, a verbal request may be made with a follow-up written request.
- B. The Contractor shall pay the County for County Inspector time outside of normal Working Hours at a rate of \$51.00/hour. The Contractor agrees that the County shall deduct such charges from the Contract Amount by a deductive Change Order.

1.03 CONTRACTOR'S USE OF PREMISES

- A. The Contractor shall assume full responsibility for the protection and safekeeping of products and materials at the job site. If additional storage or work areas are required, they shall be obtained by the Contractor at no additional cost to the Owner.

1.04 SEQUENCE OF WORK

- A. The Contractor shall establish his work sequence based on the use of crews to facilitate completion of construction and testing within the specified Contract Time.
- B. The sequence of demolition and renovation of the existing facilities will be in accordance with the approved demolition and removal plan. Below is basic outline of project sequence at each of the pump stations which may be used as the basis for Contractor's detailed sequence of construction.

C.

1. **Pump Station 3309 – Lena Street**

Install silt fencing, and clear and grub pump station site and adjacent area.

Install new water service line, backflow preventer and hose bibb.

Install emergency pump out connection, upstream plug valve and connect to existing force main.

By-pass flow from wet well to emergency pump out connection.

De-scale and CIPP line segment of influent gravity sewer pipe.

Remove existing valve vault, top slab, valves and piping

Coat existing valve vault, install new valves, piping and appurtenances and install new top slab.

Remove existing wet well top slab, pumps, piping, rails and equipment.

Line existing wet well, install new pumps, piping and equipment; and install new top slab.

Install new electrical service and remove existing electrical system including rack and panels.

Install new electrical rack, panels and relocate existing SCADA panel.

Grade site, construct driveway, concrete pad and concrete curbing.
Install crushed stone, sod disturbed areas and remove silt fencing.

2. Pump Station 3365 – University at Rouse

Install silt fencing.

De-scale and CIPP line two segments of influent gravity sewer pipe.

Remove existing pump station and pond site fencing.

Clear and grub pump station site and adjacent area.

Raise elevation of existing sanitary manhole to final grade.

Wet tap existing 12-inch force main, install new 8-inch force main and install emergency pump out connection.

By-pass flow from wet well to emergency pump out connection.

Remove existing valve vault, meter vault, valves and piping.

Remove existing site pavement and driveways.

Remove existing electrical rack and panels.

Remove existing wet well top slab, equipment from wet well, remove existing liner from wet well.

Re-line and re-equip wet well, install new top slab and riser.

Fill pump station site and adjacent area to approximate final grades.

Install new electrical service, new electrical rack, control panel and relocate SCADA panel.

Install water meter, water service line, reduced pressure backflow preventer and hose bibb.

Final grade site, construct concrete pads, driveways, sidewalks, pump station fencing with gates and concrete curbing, and pond fencing with gates.

Install crushed stone, sod disturbed areas and remove silt fencing.

3. Pump Stations 3887 – Greenview Pines and PS 3890 – Bradford Cove

Install temporary bypass of pump stations by providing pumping systems at the upstream manholes for the two pump stations. Temporary force main from pumping system will discharge to the existing force mains downstream of the pump stations through a wet-tap connection.

Remove existing pumps, structures, control panels, piping, vaults and appurtenances.

Construct wet well and / or vault, influent gravity piping (if needed) and discharge piping improvements.

Install new electrical controls.

Complete start-up and testing of the pump station improvements

Discontinue bypass pumping and place modified pump stations in service.

Complete site work, entrance drive and fencing for the pump stations.

4. Pump Station 3893A – Allison Oaks (replacement of PS 3893)

Construct the proposed pump station wet well, valve vault, pumping system, influent gravity sewer, effluent force main, electrical and instrumentation and site work.

Complete start-up and testing for the new pump station 3893A.

Install bypass pumping from the existing upstream manhole of PS 3893 with temporary force main piping to tie into the proposed emergency pump connection and force main for PS 3893A.

Connection of gravity sewer piping to the PS 3893A and Demolition of PS 3893.

Discontinue bypass pumping and place PS 3893A in service.

Complete site work, entrance drive and fencing for PS 3893A.

1.05 PUBLIC UTILITY INSTALLATIONS AND STRUCTURES

- A. The Contractor shall give written notice to all governmental utility departments and other owners of public utilities of the location of the proposed construction operations, at least seventy-two hours in advance of breaking ground in any area or on any unit of the Work.
- B. Some of the utility contacts are listed on the plans for the Contractor's convenience.
- C. The maintenance, repair, removal, relocation or rebuilding of the public utility installation and structures, when accomplished by the Contractor as herein provided, shall be done by methods approved by the utility involved.

PART 2 - PRODUCTS (NOT USED)

PART 3 - EXECUTION (NOT USED)

END OF SECTION

SECTION 01021
SOILS REPORT AND OTHER INFORMATION

PART 1 - GENERAL

1.01 REQUIREMENTS INCLUDED

- A. Identification of reports of existing conditions.

Bidder's/Contractor's responsibilities for investigating and working with existing conditions.

1.02 LAND IN-ADDITION TO THE SITE

- A. Contractor is responsible for obtaining any lands, areas, properties, facilities and easements, in addition to those furnished by the County, that the Contractor considers necessary for temporary facilities, storage, disposal of spoil or waste material or other purposes the Contractor determines necessary to complete the Work. Contractor shall provide written documentation from owner to use such land or facilities. The County/Professional and the Geotech do not assume any responsibility for existing conditions at such lands, areas, properties, facilities and /or easements obtained by the Contractor.

1.03 SUBSURFACE CONDITIONS AND OTHER PHYSICAL CONDITIONS

- A. This Section identifies reports of explorations and tests of subsurface conditions, and drawings of physical conditions of existing surface and subsurface structures that have been used in the preparation of the Contract Documents. Contractor may rely upon any technical information and data in those reports found in Appendix A, "Geotechnical Report (includes geotechnical investigation and dewatering ground water quality values per Chapter 62-621, paragraph 62-621.300(2), F.A.C.)." The Report(s) in Appendix A is designated as Authorized Technical Data, but those reports and drawings are not part of the Contract Documents.
- B. Any conclusions or interpretations made by the Contractor based on any Authorized Technical Data will be at the Contractor's own risk. Contractor's reliance on any non-technical information, data, interpretations or opinions also will also be at Contractor's own risk. The County/Professional assume no responsibility for any understanding reached or representation made about subsurface conditions and physical conditions of existing structures, except as otherwise expressly shown in or represented by the Authorized Technical Data provided.

- C. The only information or data contained in the geotechnical report and used in the preparation of the Contract Documents that may be properly considered authorized technical data concerning subsurface conditions is found in Appendix A "Geotechnical Report". Such technical data are made available to allow the Contractor to have access to the same information available to the County. The County/Professional do not warrant the accuracy or completeness of any such information or that the Contract Documents identify all the existing relevant reports and/or documents.

1.04 UNDERGROUND UTILITIES

- A. Information or data about physical conditions of Underground Utilities, which have been used in the preparation of the Contract Documents, is shown or indicated in the Drawings and technical specifications. Such information and data is based on information and data obtained from record documents or furnished to the County by the owners of those Underground Utilities or by others.

PART 2 - PRODUCTS (NOT USED)

PART 3 - EXECUTION

3.01 EXISTING GROUND SURFACE AND UNDERGROUND CONDITIONS; GENERALLY

- A. Where existing ground conditions are shown on the plans hereto attached, the elevations are believed to be reasonably correct but are not guaranteed to be absolutely so, and, together with any schedule of quantities, are presented only as an approximation. The Contractor shall satisfy itself, however, by actual examination of the site of the Work, as to the existing elevations and the amount of work required under the Contract.
- B. Where test pits and borings have been dug, the results supplied to the County/Professional by the soils Engineer may be given on the plans or are on file in the County/Professional's office and available for review . The County does not guarantee the accuracy or correctness of this information. If the Contractor desires any additional information relating to the soils investigation, contact the County/Professional to obtain such information. County does not guarantee the accuracy or correctness of any such information supplied to the Contractor.

- C. If, upon notice of a differing subsurface or latent physical condition from the Contractor, the County determines there was no unforeseen condition and unnecessary tests and investigations were conducted solely at the Contractor's request, any unnecessary expenses may be deducted from the Final Payment for the Contract. No increase in Contract Amount or Contract Time will be made if the differing site conditions were known or could have been discovered by the types of examinations that the Contractor, as Bidder, was responsible for. Claims based on groundwater table conditions will not be considered unforeseen subsurface conditions and will not be allowed. Any information indicated in the Contract Documents as to the groundwater table conditions has been provided for general information purposes only and is not intended to represent that the same conditions will exist during the execution of the Work. Further, no increase in Contract Amount or Contract Time will be made for costs incurred prior to the Contractor's written notice as required by the Contract Documents. The County will be allowed at least 10-days to investigate any alleged differing site conditions and to take appropriate action, before the Contractor is entitled to any adjustment in Contract Amount or Contract Time for Delay.

3.02 UNDERGROUND UTILITIES:

- A. The Contractor will be responsible for the safety and protection of, and providing for the repair of any damage done to the Work and existing surface and subsurface structures. The Contractor will be responsible for any damages and injury resulting from the failure to excavate in a careful and prudent manner.
- B. Contractor shall have full responsibility for locating all underground pipelines, conduits, ducts, cables, wires, manholes, vaults, tanks, tunnels, or other such facilities or attachments, and any encasements containing such facilities, including those that convey electricity, gases, steam, liquid petroleum products, telephone or other communications, cable television, water, wastewater, stormwater, other liquids or chemicals, or traffic or other control systems, shown or indicated in the Contract Documents, in advance of construction, coordinating the Work with the actual locations found and making note of the actual locations on the record Drawings. Contractor shall exercise extreme caution when locating underground facilities to minimize the risk of damage from Contractor's activities. The Contractor will immediately notify the County and the owner of any Underground Utilities that are inaccurately identified or located on the Drawings.
- C. The Contractor will be responsible for any delay and all costs relating to the obligations set forth in this Section, except as provided by allowances specific to Underground Utilities.
- D. The Contractor will promptly notify the County, in writing, whenever the Contractor discovers that actual physical conditions of Underground Utilities differ materially from those indicated by the Contract Documents or Authorized Technical Data provided with the Contract Documents. Further, the Contractor promptly will notify the County, in writing, whenever the Contractor encounters Underground Utilities not shown or indicated in/through the Contract Documents, and which could not reasonably have been foreseen.

- E. The County and Contractor will follow the provisions of the General Conditions with respect to any conclusions reached by the County after the County compares the actual underground utility conditions with those included in the information provided to the Contractor.

3.03 ENVIRONMENTAL PROCEDURES FOR HAZARDOUS MATERIALS

- A. The Contractor will not, at any time, cause or permit any Hazardous Materials to be brought upon, stored, manufactured, blended, handled, or used in, on, or about the Project or the Site for any purpose except as lawful and necessary and in accordance with the Contract Documents. The Contractor will not cause or permit Hazardous Materials to be brought on Site unless they have been specifically pre-identified by the Contractor, and approved in writing in advance by the County.
- B. The Contractor will defend, save, indemnify and hold harmless the County, their agents and employees from and against all liabilities, claims, damages, losses and expenses including attorneys' fees, which arise at any time during or after completion of the Work as a result of or in connection with:
 - 1. The Contractor's breach of any prohibition or requirement set forth in this Section or,
 - 2. Any Hazardous Materials discharged, released, deposited or introduced in the soil or surface or groundwater in, on, under, or about the Work, the Site or other properties as a result of the activities of the Contractor, the Subcontractors and their respective agents and employees in connection with the Work.
- C. This Contractor's indemnity obligation includes without limitation, costs incurred in connection with any investigation of site conditions or any cleanup, remediation, removal, or restoration required by the County or any federal, State, or local Public Agency because of:
 - 1. The occurrence of any Hazardous Materials present in the soil or surface or groundwater in, on, under, or about the Work or the Site;
 - 2. The diminution in value of the Work or the Site;
 - 3. Damages for the loss or restriction on use of the Work or of any amenity of the Work or the Property; and/or
 - 4. Amounts paid in settlement of claims, penalties, attorneys' fees, court costs, consultant and laboratory fees and experts' fees.
- D. The Contractor will immediately notify the County in writing of any significant release of Hazardous Materials at the Project or the Site, specifying the nature and quantity of the release, the location of the release, and the measures taken to contain and clean up the release and ensure that future releases do not occur.
- E. The Contractor agrees that insulation and any other construction materials containing asbestos or urea formaldehyde will not be used on the Work, and that all Sub-agreements will prohibit the use of construction materials (including, but not limited to, insulation) containing asbestos or urea formaldehyde.

3.04 DIFFERING HAZARDOUS MATERIAL CONDITIONS:

- A. If the Contractor unexpectedly encounters material reasonably believed to be Hazardous Material, the Contractor will immediately stop all affected Work, give written notice to the County and take appropriate health and safety precautions. Unless the Contract Documents require otherwise, the Contractor will conduct an investigation. If upon due investigation, the Contractor determines the material a Hazardous Material that may present a danger to persons or the surroundings, the Contractor will recommend a solution to the County. In any such case, the affected Work will be considered to have been under a suspension of Work.
- B. If the Hazardous Material is not required Work under the Drawings and/or Specifications, the County will proceed to have the Hazardous Material removed or rendered harmless through a Change Order or by means of another contract or as the County otherwise deems expedient. Alternatively, the County will terminate the affected Work or Contract for the County's convenience.
- C. If the County did not elect termination, once the Hazardous Material has been removed or rendered harmless, the affected Work will be resumed as directed in writing by the County. Any determination by the Florida Department of Community Health or the Department of Environmental Quality that the Hazardous Material has been removed or rendered harmless will be binding upon the County and Contractor for the purposes of resuming the affected Work.
- D. If the Contractor is responsible for the Hazardous Material, the Contractor will bear its proportionate share of the delay and costs involved in cleaning up the Site and removing and rendering it harmless to the satisfaction of the County and all Political Subdivisions with jurisdiction. The Contractor will be solely responsible if the Hazardous Material was brought to the Site by the Contractor, or results in whole or in part from any violation by the Contractor of any applicable Laws.
- E. If the Contractor is responsible, but fails to take appropriate action, and the County acts accordingly, the Contractor will defend, save, indemnify and hold harmless the County from and against all claims arising from the County's exercise of appropriate action.
- F. If the Contractor is not responsible, the County will issue a Change Order with the necessary changes. The Change Order will adjust Contract Amount and/or Contract Time as made necessary by the changes and resulting unreasonable delay under the circumstances attributable to the County /Professional.

3.05 INCIDENTS WITH ARCHAEOLOGICAL FEATURES:

- A. The Contractor will immediately notify in writing, the County and all Federal, State and local agencies with jurisdiction of any Archaeological Feature deposits encountered or unearthed. The Contractor will protect such Archaeological Features in a proper and satisfactory manner. No further disturbance of the Archaeological Features will take place until work is allowed to resume in the affected areas.

- B. If the County concludes that the Contract Documents require changes because of Archaeological Feature deposits encountered, the County will issue a Change Order with the necessary changes in the Work. The Change Order also will adjust Contract Amount and/or Contract Time as made necessary by those changes and by any resulting unreasonable delay under the circumstances attributable to the County/Professional.

END OF SECTION

SECTION 01025
MEASUREMENT AND PAYMENT

PART 1 - GENERAL

1.01 REQUIREMENTS INCLUDED

This Section specifies administrative and procedural requirements to define pay items and determine payable amounts, and includes but is not limited to:

1. General Provisions
2. Work Not Paid for Separately
3. Measurement for Payment
4. Partial Payment for Stored Materials and Equipment

1.02 GENERAL PROVISIONS

This specification includes standard descriptions for all bid items. This Contract's specific bid items are listed in the Bid Schedule.

The total Contract Amount shall cover the Work required by the Contract Documents. All costs in connection with the successful completion of the Work, including furnishing all materials, equipment, supplies, and appurtenances; providing all construction, equipment, and tools; and performing all necessary labor and supervision to fully complete the Work, shall be included in the unit and lump sum prices bid. All Work not specifically set forth as a pay item in the Bid Form shall be considered a subsidiary obligation of the Contractor and all costs in connection therewith shall be included in the prices bid.

If used, all estimated quantities stipulated in the Bid Schedule or other Contract Documents are approximate and are to be used only (a) for the purpose of comparing the bids submitted for the Work, and (b) as a basis for determining an initial Contract Amount. The actual amounts of Work completed and materials furnished under unit price items may differ from the estimated quantities. The County does not expressly or by implication represent that the actual quantities involved will correspond exactly to the quantities stated in the Bid Schedule; nor shall the Contractor plead misunderstanding or deception because of such estimate or quantities or of the character, location or other conditions pertaining to the Work. Payment to the Contractor will be made only for the actual quantities of work performed or material furnished in accordance with the Drawings and other Contract Documents, and it is understood that the quantities may be increased or decreased as provided in the General Conditions.

If used, the unit prices listed in the Bid Schedule shall include all services, obligations, responsibilities, labor, materials, devices, equipment, royalties and license fees, supervision, temporary facilities, construction equipment, bonds, insurance, taxes, clean up, traffic control, control surveys, field offices, close out, overhead and profit and all connections, appurtenances and any other incidental items of any kind or nature, as are necessary to complete the Work in accordance with the Contract Documents.

Except for mobilization/demobilization and project record documents, payment for Work will be based on the percent of completed work of each item in the Schedule of Values, including stored materials, as determined by the County. Progress of work in each item of the Schedule of Values will be determined separately by the County. However, the County will issue a single payment certificate for progress on the Contract.

The Contractor agrees that it will make no claim for damages, anticipated profits, or otherwise because of any difference between the amounts of work actually performed and materials actually furnished and the estimated amounts therefore.

Where payment by scale weight is specified under certain items, the Contractor shall provide suitable weighing equipment which shall be kept in accurate adjustment at all times and certified. The weighing of all material shall be performed by the Contractor in the presence and under the supervision of the County.

All schedules included in the Contract Documents are given for convenience and are not guaranteed to be complete. The Contractor shall assume all responsibility for the making of estimates of the size, kind, and quantity of materials and equipment included in work to be done under this Contract.

Where pipe fittings are noted on the Drawings, such notation is for the Contractor's convenience and does not relieve the Contractor from laying and jointing different or additional items where required.

1.03 WORK NOT PAID FOR SEPARATELY

Delivery: Payment for equipment delivery, storage or freight shall be included in the pay items including their installation and no other separate payment will be made therefore.

Bonds: Payment for bonds required by the Contract shall be included in the pay items for the Work covered by the required bonds and no separate payment will be made.

Preparation of Site: Payment for preparation of site shall be included in pay items proposed for the various items of Work and no separate payment will be made therefore. Preparation of site includes setting up construction plant, offices, shops, storage areas, sanitary and other facilities required by the specifications or state law or regulations; providing access to the site; obtaining necessary permits and licenses; payments of fees; general protection, temporary heat and utilities including electrical power; providing shop and working drawings, certificates and schedules; providing required insurance; cleaning up; and all other work regardless of its nature which may not be specifically referred to in a Bid Item but is necessary for the complete construction of the project set

forth by the Contract.

Permitting & Permit Fees.

The County reserves the right to delete any item included in the Schedule of Values and decrease the Contract Price by the scheduled amount for the item deleted.

1.04 MEASUREMENT FOR PAYMENT

Methods of Measurement - Generally:

1. Units of measurement shall be defined in general terms as follows:
 - a. Linear Feet (LF)
 - b. Square Feet (SF)
 - c. Square Yards (SY)
 - d. Cubic Yards (CY)
 - e. Each (EA)
 - f. Sacks (SK)
 - g. Lump Sum (LS)
2. Unit Price Contracts/Items:
 - a. Linear Feet (LF) shall be measured along the horizontal length of the centerline of the installed material, unless otherwise specified. Pipe shall be measured along the length of the completed pipeline, regardless of the type of joint required, without deduction for the length of valves or fittings. Pipe included within the limits of lump sum items will not be measured.
 - b. Square Feet (SF), Square Yards (SY), Cubic Yards (CY), Each (EA) and Sacks (SK) shall be measured as the amount of the unit of measure installed and compacted within the limits specified and shown in the Specifications and Drawings. Slope angles and elevations shall be measured using land-surveying equipment. Contractor shall provide supporting documentation (i.e. drawings, delivery tickets, invoices, survey calculations, etc.) to verify actual installed quantities.

Lump Sum Contracts/Items - Generally:

3. Quantities provided in the Schedule of Values are for the purpose of estimating the completion status for progress payments. Payment will be made for each individual item on a percentage of completion basis as estimated by the Contractor and approved by the County.
4. Adjustments to costs provided in the accepted Schedule of Values may be made only by Change Order.
5. The County reserves the right to delete any item included in the Schedule of Values and decrease the Contract Price by the scheduled amount for the item deleted.

1.05 MEASUREMENT AND PAYMENT ITEMS

Only those bid items included in the Bid Schedule are applicable for this Contract. The County has standardized the measurement and payment items. Currently, there are approximately 100 measurement and payment items describing approximately 300 bid

items. The bid item numbering system comprises five sections that are divided into 23 subsections. The sections and subsections are listed below.

- 10. General Requirements
 - 10.1 General
- 11. Site Work
 - 11.1 Miscellaneous
 - 11.2 Road Work
 - 11.3 Install/Replace Fence or Wall
 - 11.4 Bypass Pumping
 - 11.5 Abandon or Remove Pipe/Structure
- 12. Pressure Pipes
 - 12.1 Pressure Pipe and Fittings and Restrained Joints
 - 12.2 Valves
 - 12.3 Tapping Sleeve and Valve Assembly
 - 12.4 Cut-in Connections to Existing Main
 - 12.5 Piping Appurtenances
 - 12.6 Directional Drill
 - 12.7 Pipe Bursting
- 13. Wastewater Collection System
 - 13.1 Cleaning Sanitary Sewers
 - 13.2 CCTV Sanitary Sewers
 - 13.3 Install/Replace Sanitary Sewer
 - 13.4 Install/Replace Sanitary Manholes
 - 13.5 Sanitary Manhole Rehabilitation
 - 13.6 Sanitary Service Laterals and Cleanouts
 - 13.7 Cured-in-Place Pipe (CIPP) Liner
 - 13.8 Sanitary Sewer Pipe Bursting
- 14. Pump Stations
 - 14.1 Wastewater Duplex Pump Station
 - 14.2 Wastewater Triplex Pump Station

All of the subsections have bid item measurement and payment descriptions. Several bid items in the Project Bid Schedule may be described with the same bid item measurement and payment description in Table A, "Measurement and Payment Items". The bid items in the Project Bid Schedule are related to the Section 01025 measurement and payment items as follows:

1. All of the bid items in the Project Bid Schedule have 8 numerical digits.
2. Table A, "Measurement and Payment Items" for each of the bid items there are five numerical digits followed by ".xxx".
3. The first 5 numerical digits of the bid item in the Project Bid Schedule designate the measurement and payment item found in Table A, "Measurement and Payment Items."

Table A

BID ITEM	Orange County Utilities MEASUREMENT AND PAYMENT ITEMS <small>Pg 1</small>
	14 PUMP STATION
	14.1 – Wastewater Duplex Pump Station
1	Reference ID 14.110.110 Duplex Pump Station (Allison Oaks PS #3893)
	<p>a. Measurement: Measurement for this item shall be based on satisfactory construction of the new Pump Station, demolition of the existing pump station, installation of new gravity sewer and manholes complete and ready for continuous operation as shown on the Drawings and specified herein.</p> <p>b. Payment: Payment of the applicable Contract lump sum price as stated in the proposal will be full compensation for furnishing all labor, materials, and equipment necessary to construct a pump station, demolish an existing pump station, install new gravity sewer and manholes, and provide bypass pumping as indicated on the Drawings. Work includes but is not necessarily limited to the following: pump station improvements including wetwell, top slab, valve vault, pumps, motors, control panel, SCADA control panel, SCADA pole, cables, rails, valves, water service connection, pressure piping and appurtenances as shown on the Drawings. All coordination with the electric power company, materials, equipment, tools, labor and fees to install an electrical service connection. Installation of all site and adjacent improvements noted on drawings including driveways and driveway connections, fencing with curb and gate, masonry walls and gates, asphalt and concrete paving, rock fill and sodding. All work required to construct, complete start-up testing and deliver a complete operational Pump Station without interruption of service.</p> <p>Payment for General Requirements (Section 01001) shall include bonds, permits, and required insurance, project signs, preconstruction audio-video documentation, maintenance of traffic, public information officer, and any other preconstruction expense necessary for the start of the work shall also be included. This Work also consists of the general project management of the Work including but not limited to, field supervision and office management, as well as other incidental cost for management of the Work during duration of the Contract. This work also includes maintenance of the field offices for the duration of the Contract.</p> <p>Measurement for various items covered under General Requirements, will not be made for payment, and all items shall be included in the lump sum price. This item will be paid upon each payment request made by the Contractor. The Contractor shall attach with the pay request invoices to substantiate the appropriate insurance and bonds have been obtained by the Contractor.</p>

	<p>Payment for Mobilization/Demobilization shall include Work consisting of the preparatory Work and operations in mobilizing for beginning Work on the Contract, including, but not limited to, movement of those personnel, equipment, supplied and incidentals to the project site, preparation of submittals, and for the establishment of temporary offices and buildings, safety equipment and first aid supplies, project signs, field surveys, sanitary and other facilities required by these specifications, and State and local laws and regulations. The Work specified in this item also consists of demobilization or the operations normally involved in ending Work on the project including, but not limited to termination and removal of temporary utility service and field offices; demolition and removal of temporary structures and facilities; restoration of the Contractor storage areas; disposal of trash and rubbish, and any other post-construction work necessary for the proper conclusion of the Work. This pay item may not exceed 5% of the Total Base Bid amount.</p> <p>Payment for Project Record Documents (Section 01720) shall be based on satisfactory progress of the Contractor to provide Project Record Documents including the certified as-built survey, in accordance with the County requirements and specifications. This pay item shall be a minimum of 1% of the Total Base Bid amount.</p> <p>Payment for Indemnification: In consideration of the Contractor's Indemnity Agreement as set out in the Contract Documents, County specifically agrees to give the Contractor \$20.00 and other good and valuable consideration, receipt of which is acknowledged upon signing of the Agreement.</p>
2	Reference ID 14.110.111 Duplex Pump Station (Greenview Pines PS #3887)
	<ol style="list-style-type: none"> a. Measurement: Measurement for this item shall be based on satisfactory construction of the new Pump Station, demolition of the existing pump station, installation of new gravity sewer and manholes complete and ready for continuous operation as shown on the Drawings and specified herein. b. Payment: Payment of the applicable Contract lump sum price as stated in the proposal will be full compensation for furnishing all labor, materials, and equipment necessary to construct a pump station, demolish an existing pump station, install new gravity sewer and manholes and provide bypass pumping as indicated on the Drawings. Work includes but is not necessarily limited to the following: pump station improvements including wetwell, top slab, valve vault, pumps, motors, control panel, SCADA control panel, SCADA pole, cables, rails, valves, water service connection, pressure piping and appurtenances as shown on the Drawings. All coordination with the electric power company, materials, equipment, tools, labor and fees to install an electrical service connection. Installation of all site and adjacent improvements noted on drawings including driveways and driveway connections, fencing with curb and gate, masonry walls and gates, asphalt and concrete paving, rock fill and sodding.

All work required to construct, complete start-up testing and deliver a complete operational Pump Station without interruption of service.

Payment for General Requirements (Section 01001) shall include bonds, permits, and required insurance, project signs, preconstruction audio-video documentation, maintenance of traffic, public information officer, and any other preconstruction expense necessary for the start of the work shall also be included. This Work also consists of the general project management of the Work including but not limited to, field supervision and office management, as well as other incidental cost for management of the Work during duration of the Contract. This work also includes maintenance of the field offices for the duration of the Contract.

Measurement for various items covered under General Requirements, will not be made for payment, and all items shall be included in the lump sum price. This item will be paid upon each payment request made by the Contractor. The Contractor shall attach with the pay request invoices to substantiate the appropriate insurance and bonds have been obtained by the Contractor.

Payment for Mobilization/Demobilization shall include Work consisting of the preparatory Work and operations in mobilizing for beginning Work on the Contract, including, but not limited to, movement of those personnel, equipment, supplied and incidentals to the project site, preparation of submittals, and for the establishment of temporary offices and buildings, safety equipment and first aid supplies, project signs, field surveys, sanitary and other facilities required by these specifications, and State and local laws and regulations. The Work specified in this item also consists of demobilization or the operations normally involved in ending Work on the project including, but not limited to termination and removal of temporary utility service and field offices; demolition and removal of temporary structures and facilities; restoration of the Contractor storage areas; disposal of trash and rubbish, and any other post-construction work necessary for the proper conclusion of the Work. This pay item may not exceed 5% of the Total Base Bid amount.

Payment for Project Record Documents (Section 01720) shall be based on satisfactory progress of the Contractor to provide Project Record Documents including the certified as-built survey, in accordance with the County requirements and specifications. This pay item shall be a minimum of 1% of the Total Base Bid amount.

Payment for Indemnification: In consideration of the Contractor's Indemnity Agreement as set out in the Contract Documents, County specifically agrees to give the Contractor \$20.00 and other good and valuable consideration, receipt of which is acknowledged upon signing of the Agreement.

3	Reference ID 14.120.110 Duplex Pump Station Rehabilitation (University at Rouse PS #3365)
	<p>a. Measurement: Measurement for this item shall be based on satisfactory rehabilitation of the existing Pump Station and the adjacent sanitary sewer collection system complete and ready for continuous operation. This item also includes the abandonment of the existing force main system by grout filling the 8-inch diameter segments of pipe and removing the 16-inch diameter aerial river crossing segments of pipe.</p> <p>b. Payment: Payment of the applicable Contract lump sum price as stated in the proposal will be full compensation for furnishing all labor, materials, and equipment necessary to rehabilitate the existing pump station and adjacent sanitary sewer collection system, in addition to abandoning the existing force main as indicated on the Drawings. Work includes but is not necessarily limited to the following: Rehabilitate the existing wet well including removing existing liner and installing new extended protective liner, install a cast-in-place concrete riser and a new lined wet well top slab, install an above grade discharge piping system, install all pumps, motors, control panel, cables, rails, valves, fittings, wet tap, pressure and gravity sanitary sewer piping and appurtenances as shown on the drawings. All maintenance of traffic, clearing and grubbing, fill material, grading, wastewater by-pass pumping, pumper trucks, erosion and sedimentation prevention and control. All demolition, removal, disposal, salvage and abandonment of existing facilities and structures including fencing, concrete driveways and pads, asphalt paving, the mechanical and electrical contents of the wet well and the damaged portions of the existing wet well liner, the existing wet well top slab, the existing valve vault, meter vault and associated piping, valves and fittings as noted in the Drawings including tie-ins, intercepts, removal and abandonment of piping, conduits and electrical services. All coordination, materials and equipment, tools, and labor to relocate the existing SCADA control panel, install a water meter, and water service connection. All coordination with the electric power company, materials, equipment, tools, labor and fees to install an electrical service connection. Installation of all site and adjacent improvements noted on drawings including concrete driveways and driveway connections, concrete sidewalk, fencing with curb and gates, concrete paving, rock fill and sodding. All materials, equipment, tools, and labor to de-scale and line (CIPP) the adjacent existing sanitary sewer collection system, and raise/ rehabilitate and coat the existing manhole indicated on the Drawings. All work required to construct, complete start-up testing, and deliver a complete operational Pump Station, rehabilitate the adjacent wastewater collection system, and abandon the existing force main without interruption of service.</p>

	<p>Payment for General Requirements (Section 01001) shall include bonds, permits, and any required insurance, project signs, pre-construction audio-video documentation, maintenance of traffic, public information officer, and any other preconstruction expense necessary for the start of the work shall also be included. This Work also consist of the general project management of the Work including, but not limited to, field supervision and office management, as well as other incidental cost for management of the Work during the duration of the Contract. This Work also includes maintenance of the field offices for the duration of the Contract. Measurement for various items covered under General Requirements, will not be made for payment, and all items shall be included in the lump sum price. This item will be paid upon each payment request made by the Contractor. The Contractor shall attach with the pay request invoices to substantiate the appropriate insurance and bonds have been obtained by the Contractor.</p> <p>Payment for Mobilization/Demobilization shall include Work consisting of the preparatory Work and operations in mobilizing for beginning Work on the Contract, including, but not limited to, movement of those personnel, equipment, supplies and incidentals to the project site, preparation of submittals, and for the establishment of temporary offices and buildings, safety equipment and first aid supplies, project signs, field surveys, sanitary and other facilities required by these specifications, and State and local laws and regulations. The Work specified in this item also consists of demobilization or the operations normally involved in ending Work on the project including, but not limited to, termination and removal of temporary utility service and field offices; demolition and removal of temporary structures and facilities; restoration of Contractor storage areas; disposal of trash and rubbish, and any other post-construction work necessary for the proper conclusion of the Work. This pay item may not exceed 5% of the Total Base Bid amount.</p> <p>Payment for Project Record Documents (Section 01720) shall be based on satisfactory progress of the Contractor to provide Project Record Documents including the certified as-built survey, in accordance with the County requirements and specifications. This pay item shall be a minimum of 1% of the Total Base Bid amount.</p> <p>Payment for Indemnification: In consideration of the Contractor's Indemnity Agreement as set out in the Contact Documents, County specifically agrees to give the Contractor \$20.00 and other good and valuable consideration, receipt of which is acknowledged upon signing of the Agreement.</p>
4	<p>Reference ID 14.120.111 Duplex Pump Station Rehabilitation (Lena Street PS #3229)</p>
	<p>a. Measurement: Measurement for this item shall be based on satisfactory rehabilitation of the existing Pump Station and adjacent sanitary sewer collection system complete and ready for continuous operation.</p>

b. Payment: Payment of the applicable Contract lump sum price as stated in the proposal will be full compensation for furnishing all labor, materials, and equipment necessary to rehabilitate the existing pump station and adjacent sanitary sewer collection system as indicated on the Drawings. Work includes but is not necessarily limited to the following: Rehabilitate and line the existing wet well, install lined wet well top slab, coat valve vault and install top slab, install pumps, motors, control panel, cables, rails, valves, fittings, pressure piping, and appurtenances as shown on the drawings. All maintenance of traffic, clearing and grubbing, fill material, grading, wastewater by-pass pumping, pumper trucks, erosion and sedimentation prevention and control. All demolition, removal, salvage and disposal of existing facilities and structures including driveway, wet well top slab, wet well mechanical and electrical contents, valve vault top slab, piping valves and fittings as noted in the Drawings including tie-ins, intercepts, conflicts, and abandonment of piping, conduits, and electrical services. All coordination, materials and equipment, tools, and labor to relocate the existing SCADA control panel, water service connection. All coordination with the electric power company, materials, equipment, tools, labor and fees to install an electrical service connection. Installation of all site and adjacent improvements noted on drawings including concrete driveway and driveway connections, concrete sidewalk, concrete paving, concrete curbing, rock fill and sodding. All materials, equipment, tools, and labor to de-scale and line (CIPP) the adjacent existing sanitary sewer collection system indicated on the Drawings. All work required to construct, test and deliver a complete operational Pump Station and rehabilitate the adjacent wastewater collection system without interruption of service.

Payment for General Requirements (Section 01001) shall include bonds, permits, and any required insurance, project signs, pre-construction audio-video documentation, maintenance of traffic, public information officer, and any other preconstruction expense necessary for the start of the work shall also be included. This Work also consist of the general project management of the Work including, but not limited to, field supervision and office management, as well as other incidental cost for management of the Work during the duration of the Contract. This Work also includes maintenance of the field offices for the duration of the Contract. Measurement for various items covered under General Requirements, will not be made for payment, and all items shall be included in the lump sum price. This item will be paid upon each payment request made by the Contractor. The Contractor shall attach with the pay request invoices to substantiate the appropriate insurance and bonds have been obtained by the Contractor.

	<p>Payment for Mobilization/Demobilization shall include Work consisting of the preparatory Work and operations in mobilizing for beginning Work on the Contract, including, but not limited to, movement of those personnel, equipment, supplies and incidentals to the project site, preparation of submittals, and for the establishment of temporary offices and buildings, safety equipment and first aid supplies, project signs, field surveys, sanitary and other facilities required by these specifications, and State and local laws and regulations. The Work specified in this item also consists of demobilization or the operations normally involved in ending Work on the project including, but not limited to, termination and removal of temporary utility service and field offices; demolition and removal of temporary structures and facilities; restoration of Contractor storage areas; disposal of trash and rubbish, and any other post-construction work necessary for the proper conclusion of the Work. This pay item may not exceed 5% of the Total Base Bid amount.</p> <p>Payment for Project Record Documents (Section 01720) shall be based on satisfactory progress of the Contractor to provide Project Record Documents including the certified as-built survey, in accordance with the County requirements and specifications. This pay item shall be a minimum of 1% of the Total Base Bid amount.</p> <p>Payment for Indemnification: In consideration of the Contractor's Indemnity Agreement as set out in the Contact Documents, County specifically agrees to give the Contractor \$20.00 and other good and valuable consideration, receipt of which is acknowledged upon signing of the Agreement.</p>
<p style="text-align: center;">5</p>	<p>Reference ID 14.120.112 Duplex Pump Station Rehabilitation (Bradford Cove PS #3890)</p>
	<p>a. Measurement: Measurement for this item shall be based on satisfactory rehabilitation of the existing Pump Station complete and ready for continuous operation.</p> <p>b. Payment: Payment of the applicable Contract lump sum price as stated in the proposal will be full compensation for furnishing all labor, materials, and equipment necessary to rehabilitate the existing pump station and provide bypass pumping as indicated on the Drawings. Work includes but is not necessarily limited to the following: Pump Station improvements and modifications including fencing and gates, masonry walls and gates, rehabilitate and line the existing wetwell, replacement of the top slab, pumps, motors, control panel, cables, rails, valves, pressure piping and appurtenances, as shown on the Drawings. All demolition, removal and disposal of existing facilities as noted in the Drawings including tie-ins, intercepts, conflicts and abandonment of piping, conduits or electrical services. All coordination, materials and equipment, tools, and labor to relocate the existing SCADA control panel, SCADA pole, water service connection, or extend an existing water service connection.</p>

All coordination with the electric power company, materials, equipment, tools, labor and fees to install an electrical service connection. Installation of all site and adjacent improvements noted on drawings including driveways and driveway connections, fencing with curb and gate, asphalt and concrete paving, rock fill and sodding. All work required to construct, complete start-up testing and deliver a complete operational Pump Station without interruption of service.

Payment for General Requirements (Section 01001) shall include bonds, permits, and required insurance, project signs, preconstruction audio-video documentation, maintenance of traffic, public information officer, and any other preconstruction expense necessary for the start of the work shall also be included. This Work also consists of the general project management of the Work including but not limited to, field supervision and office management, as well as other incidental cost for management of the Work during duration of the Contract. This work also includes maintenance of the field offices for the duration of the Contract.

Measurement for various items covered under General Requirements, will not be made for payment, and all items shall be included in the lump sum price. This item will be paid upon each payment request made by the Contractor. The Contractor shall attach with the pay request invoices to substantiate the appropriate insurance and bonds have been obtained by the Contractor.

Payment for Mobilization/Demobilization shall include Work consisting of the preparatory Work and operations in mobilizing for beginning Work on the Contract, including, but not limited to, movement of those personnel, equipment, supplied and incidentals to the project site, preparation of submittals, and for the establishment of temporary offices and buildings, safety equipment and first aid supplies, project signs, field surveys, sanitary and other facilities required by these specifications, and State and local laws and regulations. The Work specified in this item also consists of demobilization or the operations normally involved in ending Work on the project including, but not limited to termination and removal of temporary utility service and field offices; demolition and removal of temporary structures and facilities; restoration of the Contractor storage areas; disposal of trash and rubbish, and any other post-construction work necessary for the proper conclusion of the Work. This pay item may not exceed 5% of the Total Base Bid amount.

Payment for Project Record Documents (Section 01720) shall be based on satisfactory progress of the Contractor to provide Project Record Documents including the certified as-built survey, in accordance with the County requirements and specifications. This pay item shall be a minimum of 1% of the Total Base Bid amount.

Payment for Indemnification: In consideration of the Contractor's Indemnity Agreement as set out in the Contract Documents, County specifically agrees to give the Contractor \$20.00 and other good and valuable consideration, receipt

	of which is acknowledged upon signing of the Agreement.
--	---

PART 2 - PRODUCTS (NOT USED)

PART 3 - EXECUTION (NOT USED)

END OF SECTION

SECTION 01027
APPLICATIONS FOR PAYMENT

PART 1 - GENERAL

1.01 REQUIREMENT

- A. This Section specifies administrative and procedural requirements governing the Contractor's Applications for Payment.
- B. Prior to submitting a monthly payment application, the Contractor's progressive As-Built Drawings and As-Built Asset Attribute Data, Gravity Main, and Pipe Deflection Tables shall be accepted by the County.
- C. Progressive As-Built Drawings shall indicate the horizontal and vertical locations of all current constructed improvements with sufficient information and notes to easily determine if the improvements were constructed in conformance with the Contract Documents. The progressive As-Built Asset Attribute Data, Gravity Main, and Pipe Deflection Tables shall include a Surveyor's certified statement regarding the constructed improvements being within the specified accuracies or if not, indicating the variances as described in specification Section 01050 "Surveying and Field Engineering", Table 01050-1 Minimum Survey Accuracies.

1.02 FORMAT

- A. Format and Content: Use the accepted Schedule of Values.
 - 1. Arrange the Schedule of Values in a tabular form with separate columns to indicate the following for each item listed:
 - a. Generic name
 - b. Related Specification Section
 - c. Name of Subcontractor
 - d. Name of manufacturer or fabricator
 - e. Name of supplier
 - f. Dollar value
 - 2. Round amounts off to the nearest whole dollar. The total shall equal the Contract Amount.

1.03 PREPARATION OF APPLICATION

- A. Each Application for Payment shall be consistent with previous applications and payments as certified and paid for by the County.
 - 1. The initial Application for Payment: The Application for Payment at time of Substantial Completion and the final Application for Payment involve additional requirements.

- B. Payment Application Times: As stated in the General Conditions, Payment applications are to be submitted monthly on a day of the month to be established by the County at the Pre-Construction conference.
- C. Application Preparation: Complete every entry on the form, including notarization and execution by person authorized to sign legal documents on behalf of the Contractor. Incomplete applications will be returned without action.
1. Submit applications typed on forms provided by the County.
 2. Use data on Bid Form and approved Schedule of Values. Provide dollar value in each column for each line item for portion of Work performed and for stored products.
 3. List each authorized Change Order and an extension or continuation sheet, listing Change Order number and dollar amount as for an original item of work.
 4. Each item shall have an assigned dollar value for the current pay period and a cumulative value for the project to-date.
 5. Submit stored material log, partial waivers of claims and mechanic liens, and consent of surety with each application, as further explained below.
- D. Submit a stored material log with each application for payment which identifies the type, quantity and value of all stored material, and that tracks when the stored materials are installed and deducts them from stored quantity at that time. Include original invoices for all stored materials that payment is requested.
- E. Waivers of Claims and Mechanics Lien: With each Application for Payment submit waivers of claims and mechanics liens from Subcontractors or Sub-subcontractors and suppliers for the construction period covered by the previous applications.
1. Submit partial waivers on each item for the amount requested, prior to deduction for retainage, on each item.
 2. When an application shows completion of an item, submit final or full waivers.
 3. The County reserves the right to designate which entities involved in the Work must submit waivers.
 4. Submit final Application for Payment with or preceded by final waivers from every entity involved with performance of work covered by the application that could lawfully be entitled to a payment claim or lien.
 5. Waiver Forms: Submit waivers of claims and lien on forms and executed in a manner acceptable to the County.
- F. Transmittal: Submit four (4) executed copies of each Application for Payment to the County by means ensuring receipt within 24-hours. One (1) copy shall be complete, including waivers of lien and similar attachments when required.
1. Transmit each copy with a transmittal form listing attachments, and recording appropriate information related to the application in a manner acceptable to the County.
 2. The Contractor shall include a certification with each application stating that all previous payments received from the County under the Contract have been applied by the Contractor to discharge in full all obligations of the Contractor in connection with the Work by prior applications for payment, and all materials and equipment incorporated into the Work are free and clear of all liens, claims, security interest and encumbrances.

- G. Initial Application for Payment: Administrative actions and submittals that must precede or coincide with submittal of the first Application for Payment include the following:
1. List of Subcontractors
 2. List of principal suppliers and fabricators
 3. Schedule of Values
 4. Contractor's Construction Progress Schedule (accepted)
 5. List of Contractor's staff assignments
 6. Copies of building permits
 7. Copies of authorizations and licenses from governing authorities for performance of the Work
 8. Certificates of insurance and insurance policies
 9. Performance and Payment bonds (if required)
 10. Data needed to acquire County's insurance
- H. Monthly Application for Partial Payment: Administrative actions and submittals that must precede or coincide with submittal of Monthly Partial Payments include the following:
1. Relevant tests
 2. Progressive As-builts (one (1) paper copy and electronic copy)
 3. Table 01050-2 Asset Attribute Data Form Examples (one (1) paper copy and electronic copy)
 4. Table 01050-3 Pipe Deflection Table Example (one (1) paper copy and electronic copy)
 5. Table 01050-4 Gravity Main Table (one (1) paper copy and electronic copy)
 6. An electronic copy of all survey field notes
 7. Partial Release of lien
 8. Partial consent of surety
 9. Site photographs
 10. Updated Progress Schedule: submit one (1) electronic copy and five (5) copies
 11. Summary of Values
 12. Pay Request
 13. On-Site Storage
- I. Substantial Completion Application for Payment: Following issuance of the Certificate of Substantial Completion, submit an Application for Payment. This application shall reflect any Certificates of Partial Substantial Completion issued previously for County occupancy of designated portions of the Work.
1. Administrative actions and submittals that shall precede or coincide with this application include:
 - a. Occupancy permits and similar approvals
 - b. Warranties (guarantees) and maintenance agreements
 - c. Test/adjust/balance records
 - d. Maintenance instructions
 - e. Meter readings
 - f. Start-up performance reports
 - g. Change-over information related to the County's occupancy, use, operation and maintenance

- h. Final Cleaning
 - i. Application for reduction of retainage and consent of surety
 - j. Advice on shifting insurance coverage
 - k. List of incomplete Work, recognized as exceptions to County's Certificate of Substantial Completion
- J. Final Completion Application for Payment: Administrative actions and submittals which must precede or coincide with submittal of the final payment Application for Payment include the following:
- 1. Prior to submitting a request for final payment or the County issuing a Certificate of Completion for the Work, the Contractor shall submit the final Record Documents to the County for approval. Retainage funds will be withheld at the County's discretion based on the quality and accuracy of the final Record Documents.
 - 2. Completion of project close-out requirements
 - 3. Completion of items specified for completion after Substantial Completion
 - 4. Assurance that unsettled claims are settled
 - 5. Assurance that work not complete and accepted is now completed
 - 6. Transmittal of required project construction records to the County
 - 7. Proof those taxes, fees and similar obligations have been paid
 - 8. Removal of temporary facilities and services has been completed.
 - 9. Removal of surplus materials, rubbish and similar elements
 - 10. Change of door locks to County's access
 - 11. Execute certification by signature of authorized officer.
 - 12. Prepare Application for Final Payment as required in General Conditions.

1.04 SUBMITTAL PROCEDURES

- A. Submit four (4) copies of each Application for Payment at time stipulated in Agreement.
- B. Submit under transmittal letter.

1.05 SUBSTANTIATING DATA

- A. When the County requires substantiating information, submit data justifying line item amounts in question.
- B. Provide one (1) copy of data with cover letter for each copy of submittal. Show Application number and date, and line item by number and description.

PART 2 - PRODUCTS (NOT USED)

PART 3 - EXECUTION (NOT USED)

END OF SECTION

SECTION 01050
SURVEYING AND FIELD ENGINEERING

PART 1 - GENERAL

1.01 DESCRIPTION

- A. Professional Surveyor: Provide professional surveying and mapping work required for the execution of the contract, including verification of existing survey data, construction layout, and production of the As-Built Drawings. This Work shall be performed by a Surveyor that is licensed by the State of Florida as a Professional Surveyor and Mapper pursuant to Chapter 472, F.S.
- B. Professional Engineer: The Contractor shall provide the services of a Registered Professional Engineer currently licensed in the State of Florida for the following specific services as applicable to the Work.

1.02 REQUIREMENTS

A. Survey Services

- 1. The Contractor shall retain the services of a registered Surveyor and Mapper licensed in the State of Florida to provide professional surveying and mapping services, and maintain both a control survey and an as-built survey during construction. The Surveyor will identify control points (monuments and benchmarks noted on the Drawings). The construction layout survey shall be established from the control points shown on the Construction Drawings and confirmed. The method of field staking for the construction of the Work shall be at the option of Contractor. The accuracy of any method of staking shall be the responsibility of Surveyor. All staking shall be done to provide for easy verification of the Work by the County. The Contractor shall provide all surveys necessary for the construction of the Work.

B. Engineering Services

- 1. The Engineer shall be responsible for duties during Construction to include, but not limited to:
 - a. Inspections, testing, witnessing requiring a licensed Professional Engineer.
 - b. Design of temporary shoring, bridging, scaffolding or other temporary construction, formwork and protection of existing structures.
 - c. Other requirements as specified herein.
- 2. Engineering related designs, tests and inspections shall be signed by the licensed Professional Engineer as required by the County.

1.03 QUALIFICATIONS OF THE SURVEYOR

- A. The Surveyor, who is proposed by the Contractor to provide services for the Project, is subject to the approval of the County. Prior to any services being performed, the Contractor shall submit the name and address of any proposed Surveyor and a written acknowledgement from the Surveyor stating that he has the hardware, software and adequate scope of services in his agreement with the Contractor to fully comply with the requirements of this specification. These submittals shall be provided to the County prior to Notice to Proceed. It is recommended that the Surveyor attend the Pre-Construction meeting. Any Surveyor, who has not previously performed work for the County shall attend the Pre-Construction meeting.

1.04 SUBMITTALS

- A. Provide qualifications of the Surveyor or Engineer.
 - 1. A Florida Registered Professional Engineer or Registered Surveyor and Mapper, who is proposed by the Contractor to provide services for the Work, shall be acceptable to the County prior to field services being performed.
 - 2. A Professional Engineer shall be of the discipline required for the specific service for the Work.
 - 3. Submit name, address and telephone number of the Surveyor and/or Engineer, as appropriate to the County for acceptance before starting survey or engineering work.
- B. On request, submit documentation verifying accuracy of survey work.
- C. Surveyor shall certify all elevations and locations included in Table 01050- 2, 3, and 4.

PART 2 - PRODUCTS

2.01 SURVEY DOCUMENTS

- A. Survey documents shall comply with the Minimum Technical Standards of Chapter 5J-17 of the Florida Administrative Code (FAC) and Table 01050-1 Minimum Survey Accuracies, whichever are more stringent. All coordinates shall be geographically registered in the Florida State Plan Coordinate System using the contract Drawings control points for horizontal and vertical controls.
- B. The Surveyor shall not copyright any of their Work related to this project.

**Table 01050-1
Minimum Survey Accuracies**

Asset	Horizontal Accuracy (feet)	Elevation Accuracy (feet)	Location: Horizontal Center and Vertical Top, unless otherwise specified
Bench Marks	0.01	0.01	Point
Baseline Control Locational Accuracy	0.01	N/A	Point
Tract and Easement Corners	*	N/A	Survey Monuments
Mains at 100-foot maximum intervals	0.1	0.1	Pipe, Pipe at Valves, Pipe at Bore & Jack Casing
PVC pipe >16-inch at every pipe joint	0.1	0.1	Pipe, Pipe at Valves, Pipe at Bore & Jack Casing
Fittings, Sleeve, Tapping Saddle, and end of the pipe if Plugged or Capped.	0.1	0.1	Fitting
Restrained Pipe	0.1	N/A	Restrained Joint Limits
Connections	0.1	0.1	Pipe
Bore & Jack Casing	0.1	0.1	Top of Casing at the Casing Limits
Directional Drill	0.1	0.1	10-foot intervals during the directional drill operation
Hydrants	0.1	N/A	Operating Nut of Hydrant
Valves	0.1	0.1	Operating Nut
Air Release, Blow off, and Backflow Valves	0.1	N/A	Valve Enclosure
Master Meters, Deduct Meters & Wastewater Meters	0.1	N/A	Register
Meter Box	0.1	N/A	Meter Box
Clean out	0.1	N/A	Clean out
Manhole Rim	0.1	0.1	Manhole
Manhole Inverts	N/A	0.01	Pipe Inverts
Pump Station (Public & Private)	0.1	0.01	Wetwell and Pipe Inverts
Production Well or Monitoring Well	0.1	0.1	Well
Grease Interceptor	0.1	0.1	
Oil / Water Separators	0.1	0.1	
Demolished Pipe (abandoned in place or removed)	0.1	0.1	Limits of Abandoned or Removed Pipe
Existing Utilities water, wastewater, reclaimed water, and appurtenant structures **	0.1	0.1	Pipe or Structure
<p>* Shall conform to the requirements of the "Chapter 5J-17, 'Minimum Technical Standards', FAC", certified by a SURVEYOR.</p> <p>** Existing utilities including but not limited to water, wastewater, reclaimed water, stormwater, fiber optic cable, electric, gas and structures within the limits of construction.</p>			

TABLE 01050-2
Asset Attribute Data Form Examples

Hydrants Worksheet

	A	C	D	E	F	G	H	I
1	ID Number	Plan Sheet #	Easting	Northing	Elevation	Manufacturer	Model #	Comments
2	FH-1	C-7	518456.40	1483743.63	49.53	Brand B	XJ7-B	
3	FH-2	C-9	518477.68	1483758.95	54.23	Brand B	XJ7-B	

Valves Worksheet

	A	C	D	E	F	G	H	I	J
1	ID Number	Plan Sheet #	Easting	Northing	Elevation	Valve Type	Main Type	Valve Size	Valve Manufacture
2	ARV-1	C301	518060.09	1483231.33	81.72	ARV - Combination	Water Main	2	Brand H
3	ARV-1	C303	518083.55	1483280.50	81.15	ARV - Vacuum	Force Main	4	Brand G
4	BFP-1	C303	518086.00	1483282.88	78.21	Backflow Preventer	Reclaimed Water Main	8	Brand F
5	BO-9	C405	518088.83	1483289.43	78.20	Blowoff	Water Main	2	Brand E
6	BFV-1	C405	518088.11	1483295.00	81.95	Butterfly	Water Main	30	Brand D
7	GV-3	C405	518132.54	1483372.75	81.23	Gate	Water Main	16	Brand C
8	LS-W1	C405	576779.36	1539706.97	64.30	Line Stop	Water Main	16	Brand B
9	PV-22	C405	576880.60	1539718.32	64.52	Plug	Force Main	12	Brand A

	J	K	L	M	N	O	P	Q
1	Valve Manufacturer	Valve Model #	# of Turns to Close	Gear Actuator	Gear Ratio	Side Actuator	uator Manufact	Comments
2	Brand H	100XT						
3	Brand G	1000						
4	Brand F	2000 fgs						
5	Brand E	14 turbo						
6	Brand D	230 xls	200	Yes	3 to 1	Yes	Brand C	
7	Brand C	2225846	300	Yes	3 to 1	NO		
8	Brand B	7n6r44						
9	Brand A	Z100	200	Yes	3 to 1	Yes	Brand A	

Manhole Worksheet

	A	C	D	E	F	G	H	I	J	K	L	M	N	O
1	ID Number	Plan Sheet #	Easting	Northing	Rim Elevation	Invert Elev II	Invert Elev IE	Invert Elev E	Invert Elev SE	Invert Elev S	Invert Elev SW	Invert Elev W	Invert Elev IW	Manufacturer
2	MH-1	C-20	517999.15	1483092.24	82.96	76.96		76.96		76.91				Brand X
3	MH-2	C-20	517999.15	1483492.24	83.54	75.63				75.58				Brand X

Meter Worksheet

	A	C	D	E	F	G	H
1	ID Number	Plan Sheet #	Easting	Northing	Elevation	Main Type	Comments
2	MM-1	C-6	576533.64	1539520.08	58.01	Water Main	
3	RWMM-1	C-6	576937.42	1539598.78	64.84	Reclaimed Water Main	

Fitting Worksheet

Microsoft Excel - Example ContractorUploadSheet 2010-0326.xls								
	A	C	D	E	F	G	H	I
1	ID Number	Plan Sheet #	Easting	Northing	Elevation	Main Type	Fitting Type	Comments
2	FM-1	C-3	572399.28	1539339.13	46.27	Force Main	Bend 11 1/4°	
3	FM-2	C-3	574840.74	1539856.91	51.73	Force Main	Bend 22-1/2°	
4	FM-3	C-3	574844.01	1539856.71	52.48	Force Main	Bend 45°	
5	FM-4	C-3	574845.72	1539856.61	52.33	Water Main	Bend 90°	
6	FM-5	C-3	574845.85	1539858.77	51.98	Water Main	Cap	
7	RW-1	C-4	574884.06	1539849.64	51.75	Reclaimed Water Main	Cross	
8	RW-2	C-4	574887.22	1539849.56	48.98	Reclaimed Water Main	Reducer	
9	RW-3	C-4	574904.30	1539849.10	49.39	Reclaimed Water Main	Plug	
10	RW-4	C-4	574907.42	1539849.01	52.32	Reclaimed Water Main	Sleeve	
11	WM-1	C-5	574938.65	1539848.16	54.42	Water Main	Tapping Saddle	
12	WM-2	C-5	572532.38	1539337.10	45.27	Water Main	Tee	
13	WM-3	C-5	572631.00	1539338.00	44.13	Water Main	Wye	
14	WM-4	C-5	572731.00	1539334.00	43.77	Water Main	Tapping Sleeve	

Cleanout Worksheet

Microsoft Excel - Example ContractorUploadSheet 2010-0326.xls						
	A	C	D	E	F	G
1	ID Number	Plan Sheet #	Easting	Northing	Elevation	Comments
2	CO-1	C-6	576533.64	1539520.08	58.01	
3	CO-2	C-6	576937.42	1539598.78	64.84	

Pipes Worksheet

Microsoft Excel - Example ContractorUploadSheet 2010-0326.xls												
	A	C	D	E	F	G	H	I	J	K	L	M
1	ID Number	Plan Sheet #	Easting	Northing	Elevation	Main Type	Type of Shot	Instruction	Material	Pressure Class	Manufacturer	Color
2	CSNG-1	C-4	517827.57	1482195.46	78.83	Force Main	Bore & Jack (Casing)		PVC	DR18	Brand A	
3	CSNG-2	C-4	517848.20	1482195.31	78.38	Force Main	Bore & Jack (Casing)		PVC	DR18	Brand A	
4	RW-1	C-7	517731.98	1482237.24	80.42	Reclaimed Water Main	Restraint Joint Limit	Open Cut	DIP	Class 250	Brand B	
5	RW-2	C-7	517732.848	1482338.1	80.943	Reclaimed Water Main	Restraint Joint Limit	Open Cut	DIP	Class 250	Brand B	
6	WM-1	C-9	573309.068	1539372.9	56.10	Water main	Shot on Pipe	Open Cut	PVC	DR18	Brand C	
7	WM-2	C-9	573308.752	1539375	54.66	Water main	Shot on Pipe	Open Cut	PVC	DR18	Brand C	
8	FMDD-1	C-4	504345.94	1488969.2	114.14	Force Main	Shot on Pipe	Directional Drill	HDPE	DR17	Brand X	
9	FMDD-2	C-4	504360.86	1488970.5	112.74	Force Main	Shot on Pipe	Directional Drill	HDPE	DR17	Brand X	
10	FMDD-3	C-4	504377.19	1488971.2	106.14	Force Main	Shot on Pipe	Directional Drill	HDPE	DR17	Brand X	
11	FM-9	C-4	504480.47	1488982.9	105.24	Force Main	Shot on Pipe	Open Cut	PVC	DR18	Brand C	

Well Worksheet

Microsoft Excel - Example ContractorUploadSheet 2010-0326.xls						
	A	C	D	E	F	G
1	ID Number	Plan Sheet #	Easting	Northing	Elevation	Comments
2	PS-1	C-40	517914.346	1482906.562	83.912	

Easements Worksheet

	A	C	D	E	F	G	H
1	ID Number	Plan Sheet #	Easting	Northing	Elevation	Boundary Corner Type	Comments
2	Corner-1	C-8	463484.59	1511029.72		Pump Station Tract	N.W. CORNER
3	Corner-2	C-8	463523.24	1511040.01		Pump Station Tract	N.E. CORNER
4	Corner-3	C-8	463480.45	1511015.23		Pump Station Tract	S.W. CORNER
5	Corner-4	C-8	463526.97	1511025.49		Pump Station Tract	S.E. CORNER
6						Easement	
7						Property	

Existing OC Utility Crossing

	A	C	D	E	F	G	H	I
1	ID Number	Plan Sheet #	Easting	Northing	Existing Pipe Elevation	Proposed Crossing Elevation	Existing Main Type	Comments
3	Conf-1	C-750	463464.47	1511013.75	100.54	104.88	Water main	
4	Conf-2	C-750	463163.91	1510693.49	98.32	103.57	Storm Main	

Grease Interceptor

	A	C	D	E	F	G	H
1	ID Number	Plan Sheet #	Easting	Northing	Elevation	Volume (Gallons)	Comments
2	GI-1	C-400	508387.3	1487203.18	89.70	1000.00	

For ease of calculating pipe deflections in Table 01050-3, begin by providing a unique asset ID (top of pipe shots and fittings) for each utility and type, numbered sequentially along the pipe run (including changes in direction) from start to finish of the pipe in the Table 01050-2. Then branches and services of the same utility type can be numbered. It is recommended that each utility (water, wastewater or reclaimed water) numbering format be distinguishable from the other. This will allow organization and convenient sorting after the individual asset table worksheet tabs are combined in the spreadsheet program prior to copying and pasting to the deflection table spreadsheet.

**TABLE 01050-3
PIPE DEFLECTION TABLE EXAMPLE**

Project Contractor: Progress Mtg Date: Contract # Dwg Sheet # Utility Type Pipe Manufacturer Pipe size & material PVC Manufacturer Deflection County Allowable Deflection 75% Allowable Angle of Offset Allowable Radius of Curvature Laying Length of Pipe	FM National Pipe 16" PVC C905 6 inches 4.5 inches 1.5 degrees 764 feet 20 feet	
--	---	--

ID	Size and Type	Northing	Easting	Elev.	Calculations Including Elevation (XYZ)							
					Distance between points AB	Distance between points BC	Distance between points AC	Total Deflection Ø°	Radius of Curve ^A	Average Offset Angle ^{***}	Average Offset ^{****}	
					Length AB ft	Length BC ft	Length AC ft	XYZ (w elevation) degrees	XYZ (w elevation) ft	per laying length degrees	per laying length inches	
14041	16" FM	1505131.50	468948.53	107.68	-	-	-	-	-	-	-	-
7000	16" FM	1505059.60	468932.08	108.15	73.76	38.93	112.66	5.48	1,178.35	0.97	4.07	
2128	16" FM	1505022.11	468921.60	108.55	38.93	39.61	78.54	2.29	1,961.65	0.58	2.45	
2127	16" FM	1504983.85	468911.35	108.29	39.61	38.35	77.96	1.78	2,505.50	0.46	1.92	
2126	16" FM	1504946.67	468901.96	107.81	38.35	39.13	77.42	8.79	505.16	2.27	9.51	
2125	16" FM	1504908.11	468895.31	107.48								

Data that has been inputted
 Values in yellow are over spec

*Uses law of cosines to determine angle ABC and Ø.
 $\text{angle } ABC = \arccos((AB^2 + BC^2 - AC^2) / (2 * AB * BC))$
 $180 - \text{angle } ABC = \text{angle } \phi$
 Calculate the total deflection Ø.
 to the outer point (A or C) is equal in angle to the approach from the next point along the

** Uses law of sines, using the chord length AC and radius R.
 $\text{Since } \sin((\phi/2) * (\pi/180)) = (\text{Chord}/2) / R \text{ and length } AC = \text{Chord}$
 $R = AC / (2 * \sin(\phi * \pi / 360))$
 This calculation assumes an average radius over the bend between three points.

*** Adds the lengths of AB + BC / 20ft to get an approximate number of bends over the span.
 This value is divided by the total deflection angle to calculate the average bend angle of
 This assumes that the bend angle consistent across the entire length.

**** Uses average offset angle and laying length of pipe.

PART 3 - EXECUTION

3.01 SURVEY FIELD WORK

- A. Locate, reference, and preserve existing horizontal and vertical control points and property corners shown on the Drawings prior to starting any construction work. If the Surveyor performing the Work discovers any discrepancies that will affect the Project, the Contractor must immediately report these findings to the County. All survey work shall meet the requirements as defined in Florida Administrative Code 5J-17. Reference and preserve all survey points during Construction. If survey points are disturbed, it is the responsibility of the Contractor's Surveyor to reset the points at the Contractor's expense. Copies of the Surveyor's field notes and/or electronic files for point replacement shall be provided to the County.
 - 1. The Surveyor shall locate all improvements for the project As-Built Asset Attribute Data using State Plane Coordinates as the horizontal datum and the benchmark referenced on the Drawings as the vertical datum. The County will provide electronic files of the Drawings to be used by the Surveyor in complying with these specifications.
 - 2. The construction layout shall be established from the reference points shown or listed on the Drawings. The accuracy of any method of staking shall be the responsibility of the Contractor. All construction layout staking shall be done such as to provide for easy verification of the Work by the County.
- B. Only a Surveyor licensed in the State of Florida shall be employed for this Work. All control points shall be protected by the Contractor from disturbance. If the monuments are disturbed, any Work that is governed by these monuments shall be held in abeyance until the monuments are reestablished by the Contractor and approved by the County. The accuracy of all the Contractor's stakes, alignments and grades is the responsibility of the Contractor. However, the County has the discretionary right to check the Contractor's stakes, alignments, and grades at any time.
- C. Use survey control points to layout such work tasks including but not limited to:
 - 1. Clearing, grubbing, work limits, right-of-way lines and easements
 - 2. Locations for pipelines and all associated structures and appurtenances
- D. The Surveyor shall reference and replace any project control points, boundary corners, benchmarks, section corners, and right-of-way monuments that may be lost or destroyed, at no additional cost to the County. Establish replacement points based on the original survey control. Copies of all reference field notes and/or electronic files for point replacement shall be submitted to the County.

3.02 SURVEYING

- A. Locate and protect existing horizontal and vertical control points shown on the construction Drawings prior to starting any work. If the Surveyor performing the Work finds differences that will effect the Work, the Contractor must immediately report the findings to the County. Establish control points, lines and levels by instrumentation and similar appropriate means. The location of these points should minimize the number of sightings necessary to control the Work and the likelihood of the points being disturbed. Preserve and reference all permanent reference points during Construction. If permanent reference points are disturbed, it is the responsibility of the Contractor's Surveyor to reset the points at the Contractor's expense. Copies of the Surveyor's field notes shall be provided to the County.
 - 1. Record locations, with horizontal and vertical data, on project As-Built survey.
 - 2. Make no changes or relocations without prior written notice to the County or without receipt of written approval from the County.
 - 3. Report to the County when any control point is lost or destroyed or requires relocation because of necessary changes in grades or locations.
- B. Cover for water, reclaimed water and force mains shall vary to provide long uniform gradient or slope to pipe to minimize air pockets and air release valves. The locations shown on the Drawings for air and vacuum release valve assemblies are approximate and the Contractor shall field adjust these locations to locate these valves at the highest point in the pipeline installed.
- C. To insure a uniform gradient for gravity pipe and pressure pipe, all lines shall be installed using the following control techniques as a minimum:
 - 1. Gravity lines: Continuous control, using laser beam technology,
 - 2. Pressure lines: Control stakes set at 50 ft. intervals using Surveyor's level instrument.

3.03 SURVEY DOCUMENTS

- A. The Tables 01050-2 Asset Attribute Data, 01050-3 Pipe Deflection Table, and 01050-4 Gravity Main Table shall be signed, sealed and dated by the Surveyor with each pay request as specified in Section 01027 "Application for Payment" and the requirements of Section 01720 "Project Record Documents."

END OF SECTION

THIS PAGE LEFT BLANK INTENTIONALLY

SECTION 01065
PERMITS AND FEES

PART 1 - GENERAL

1.01 REQUIREMENTS

A. General

1. Upon Notice of Award, obtain and pay for all appropriate and applicable permits and licenses as provided for in the General Conditions, except as otherwise provided herein.
2. Schedule all inspections and obtain all written approvals of the agencies required by the permits and licenses.
3. Strictly adhere to the specific requirements of the governmental unit(s) or agency(cies) having jurisdiction over the Work. Whenever there is a difference in the requirements of a jurisdictional body and the Contract Documents, the more stringent shall apply.
4. A copy of the permits obtained by the County are furnished in Appendix C "Permits Obtained by County" of these specifications.
5. Unless otherwise specified, the cost of work specified in the various sections of Division 1, will not be paid for separately but the cost therefore shall be considered incidental to and included in the bid prices of the various Contract items.

B. Building Permit (Orange County)

1. The County will pay the general building permit fee and any related impact fees or assessments to be paid to Orange County for the issuance of that permit only.
2. The Contractor shall pay all fees associated with obtaining Orange County trade permits and any and all inspection fees for the Orange County Building Department providing inspections for this project. The Contractor shall apply for and obtain the building permits from Orange County and schedule and obtain final approval from the building inspectors.
3. Information on Orange County Building Department fees is included in the Instructions to Bidders in Division 0.
4. The Contractor shall be responsible for scheduling all permit inspections and obtaining inspection approval from Orange County, as required by the building and sub-discipline construction permits.

C. Construction Dewatering Permit

The Contractor shall apply and pay for all fees associated with obtaining Florida Department of Environmental Protection District Office construction dewatering permits, if required. The Contractor shall provide all materials and equipment to comply with the permit requirements at no additional cost to the County.

PART 2 - PRODUCTS (NOT USED)

PART 3 - EXECUTION (NOT USED)

END OF SECTION

SECTION 01070
ABBREVIATIONS AND SYMBOLS

PART 1 - GENERAL

1.01 REQUIREMENTS INCLUDED

- A. Reference to the following standards of any technical society, organization or body shall be construed to mean the latest standard, code or specification or tentative specification adopted and published at the date of advertisement for bids, even though reference has been made to an earlier standard. Such reference is hereby made a part of the Contract the same as if herein repeated in full and in the event of any conflict between any of these specifications, standard codes or tentative specifications and the Contract Documents, the most stringent shall govern.

AA	Aluminum Association
AASHTO	American Association of State Highway and Transportation Officials
ABPA	Acoustical and Board Products Association
ACI	American Concrete Institute
AFBMA	Anti-Friction Bearing Manufacturer's Association
AGA	American Gas Association
AGMA	American Gear Manufacturers Association
AI	The Asphalt Institute
AIA	American Institute of Architects
AIEE	American Institute of Electrical Engineers
AIMA	Acoustical and Insulating Materials Association
AISC	American Institute of Steel Construction
AISI	American Iron and Steel Institute
AMCA	American Moving and Conditioning Association
ANSI	American National Standards Institute
API	American Petroleum Institute
APWA	American Public Works Association
AREA	American Railway Engineering Association
ASA	American Standards Association (now ANSI)
ASCE	American Society of Civil Engineers
ASHRAE	American Society of Heating, Refrigerating, and Air Conditioning Engineers
ASME	American Society of Mechanical Engineers
ASSCBC	American Standard Safety Code for Building Construction
ASTM	American Society for Testing and Materials
AWPA	American Wood Preservers Association
AWBP	American Wood Preservers Board
AWS	American Welding Society
AWWA	American Water Works Association

CRSI	Concrete Reinforcing Steel Institute
CS	Commercial Standard
DOT Spec	Standard Specification for Road and Bridge Construction –
FDOT	Florida Department of Transportation
FAC	Florida Administrative Code
FS	Federal Standard
IEEE	Institute of Electrical and Electronic Engineers
IPCEA	Insulated Power Cable Engineers Association
NACE	National Association of Corrosion Engineers
NASSCO	National Association of Sewer Service Companies
NBFU	National Board of Fire Underwriters
NBS	National Bureau of Standards
NEC	National Electrical Code
NECA	National Electrical Contractor's Association
NEMA	National Electrical Manufacturers Association
NFPA	National Fire Protection Association
NPT	National Pipe Threads
NSF	National Science Foundation
OSHA	U.S. Department of Labor, Occupational Safety and Health Administration
PCA	Portland Cement Association
PCI	Prestressed Concrete Institute
PS	United States Products Standards
SAE	Society of Automotive Engineers
SDI	Steel Decks Institute
SJI	Steel Joists Institute
SMACNA	Sheet Metal and Air Conditioning Contractors National Association
SSPC	Structural Steel Painting Council
UL	Underwriter's Laboratories, Inc.
USASI	United States of American Standards Institute (Now ANSI)

B. UNITS OF MEASUREMENT

CU FT	cubic feet
CU IN	cubic inch(es)
CY	cubic yard(s)
DegC	degree(s) Centigrade
DegF	degree(s) Fahrenheit
F	Fahrenheit
FT	feet, foot
G	gram(s)
GA	gage
GAL	gallon(s)
GPH	gallon(s) per hour
GPM	gallon(s) per minute

GPS	gallon(s) per second
HR	hour(s)
IN	inch(es)
IPS	iron pipe size
KG	kilogram(s)
L	liter(s)
LB	pound(s)
LBF-IN	pound (force) inch
LF	linear foot, linear feet
MIN. min.	minute(s), minimum
ml	milliliter
MO	month(s)
OZ	ounce(s)
QT	quart
RH	relative humidity
SF	square foot, square feet
SQ IN	square inch(es)
YD	yard(s)
YR	year(s)

C. TERMINOLOGY

@	at
AB	anchor bolt
ADJ	adjust, adjustable
ADMIN	administration
AFG	above finished grade
AGGR	aggregate
AL	aluminum
ALT	alternate
APPX	appendix
APX	approximate
ART	article
ASPH	asphalt
ASSY	assembly
AUTO	automatic
AUX	auxiliary
AVE	avenue
AVG	average
AWG	American Wire Gauge
BAR	barrier
BCCMP	bituminous coated corrugated metal pipe
BL	base line
BLDG	building
BLKG	blocking
BM	beam

C to C	center to center
CCB	concrete block, masonry
CEM	cement
CIP	cast iron pipe, cast in place
CJ	construction joint
CL	center line, clearance
CM	Construction Manager
CMP	corrugated metal pipe
CO	cleanout
CONC	concrete
CONN	connection
CONST	construction
CONT	continuous
CONTR	contractor
CU, COP	copper
ORR	corridor
CRIT	critical
CTD	coated
CTR	center
CULV	culvert
d	delta
DBL	double
DEM	demolition, demolish
DEPT	department
DET	detail
DIA, D	diameter
DIAG	diagonal
DIM	dimension
DWG	drawing
FEM	female
FUT	future
FV	field verify
FM	force main
FH, HYD	fire hydrant
ID	inside diameter
MAS	masonry
MATL	material
MAX	maximum
MFD	manufactured
MFG	manufacturing
MFR	manufacturer
MH	manhole, metal hallide
MIN	minimum
MISC	miscellaneous
MTL	material

NAT	natural
NATL	national
NOM	nominal
NTS	not to scale
OD	outside diameter
PP	power pole
R	radius
Rd	road
REIN	reinforce
REL A	relief air
REQD	required
REV	revision
RR	railroad
R/W	right-of-way
RWM	reclaimed water main
RY	railway
SAN	sanitary
SCH	schedule
SECT	section
SLV	sleeve
SQ	square
SST	stainless steel
ST	street
STA	station
STD	standard
SURF	surface
SUSP	suspend(ed)
SYM	Symbol, symmetrical
SYS	system
TEMP	Temperature, temporary
TYP	typical
UTIL	utility
W	West
WLD	welded
WM	water main
W/O	without
WT	weight
YD	yard
YR	year
Y W	wye

END OF SECTION

THIS PAGE LEFT BLANK INTENTIONALLY

SECTION 01091
REFERENCE SPECIFICATIONS

PART 1 - GENERAL

1.01 GENERAL

- A. Applicable Publications: Whenever in these Specifications references are made to published specifications, codes, standards, or other requirements, it shall be understood that wherever no date is specified, only the latest specifications, standards, or requirements of the respective issuing agencies which have been published as of the date that the Work is advertised for bids, shall apply; except to the extent that said standards or requirements may be in conflict with applicable laws, ordinances, or governing codes. No requirements set forth herein or shown on the Drawings shall be waived because of any provision of or omission from said standards or requirements.

- B. Assignment of Specialists: In certain instances, specification test requires (or implies) that specific work is to be assigned to specialist or expert entities who must be engaged for the performance of the Work. Such assignments shall be recognized as special requirements over which the Contractor has no choice or option. These requirements shall not be interpreted so as to conflict with the enforcement of building codes and similar regulations governing the Work. They are not intended to interfere with local union jurisdiction settlements and similar conventions. Such assignments are intended to establish which party or entity involved in a specific unit of Work is recognized as "expert" for the indicated construction processes or operations. Nevertheless, the final responsibility for fulfillment of the entire set of Contract requirements remains with the Contractor.

1.02 REFERENCE SPECIFICATIONS, CODES, AND STANDARDS

- A. Without limiting the generality of other requirements of the Specifications, all Work specified herein shall conform to or exceed the requirements of such referenced documents which are not in conflict with the requirements of these Specifications or applicable codes.

- B. References herein to "Building Code" shall mean the Florida Building Code. The latest edition of the code shall apply to the Work herein, including all addenda, modifications, amendments, or other lawful changes thereto.

- C. In case of conflict between codes, reference standards, Drawings, and the other Contract Documents, the most stringent requirements shall govern. All conflicts shall be brought to the attention of the Engineer for clarification and directions prior to ordering or providing any materials or labor. The Contractor shall bid the most stringent requirements.

D. Applicable Standard Specifications: The Contractor shall construct the Work specified herein in accordance with the requirements of the Contract Documents and the referenced portions of those referenced codes, standards, and specifications listed.

PART 2 - PRODUCTS (NOT USED)

PART 3 - EXECUTION (NOT USED)

END OF SECTION

SECTION 01200
PROJECT MEETINGS

PART 1 - GENERAL

1.01 REQUIREMENTS INCLUDED

- A. Contractor participation in pre-construction conferences, progress meetings and specially called meetings.

1.02 MEETINGS CALLED BY THE COUNTY

- A. The County will schedule and administer a pre-construction conference, periodic progress meetings and specific topic meetings throughout the progress of the Work. The County will:
 - 1. Prepare and distribute a notification of the meeting to required attendees.
 - 2. Establish, prepare and distribute an agenda with the notification.
 - 3. Make physical arrangements for the meetings.
 - 4. Preside at meetings.
 - 5. Prepare and distribute minutes of meetings including significant proceedings and decisions, within 15 working days after each meeting. Minutes will be forwarded to all participants and to parties affected by decisions made at the meeting.
- B. Representatives of the Contractor, Subcontractors and suppliers attending meetings shall be qualified and authorized to act on behalf of the entity each represents.
- C. The meeting location will generally be a central site, convenient for all parties, designated by the County.

1.03 PRE-CONSTRUCTION CONFERENCE

- A. Attendance:
 - 1. County
 - 2. Contractor and superintendent
 - 3. Subcontractors as appropriate to the agenda
 - 4. Representatives of suppliers and manufacturers as appropriate to the agenda
 - 5. County MBE/WBE representative
 - 6. Other agency representatives (FDEP, EPA, City, etc.)
 - 7. Others as requested by the County or Contractor

B. Suggested Agenda:

1. Distribution and discussion of:
 - a. List of major Subcontractors and suppliers
 - b. Construction schedules
 - c. Contact information
2. Organizational arrangement of Contractor's forces and personnel, and those of Subcontractors, material and equipment suppliers, and the County
3. Critical work sequencing
4. Major equipment deliveries
5. Project coordination
 - a. Designation of responsible personnel
 - b. Channels and procedures for communication
6. Procedures and processing of:
 - a. Field decisions
 - b. Proposal requests
 - c. Submittals
 - d. Change orders
 - e. Applications for payment/Schedule of Values
 - f. Contractor quality control
 - g. Submittal of Shop Drawings, project data and samples
7. Adequacy of distribution of Contract Documents
8. Procedures for maintaining as built and record documents
9. Use of premises:
 - a. Office, work and storage areas
 - b. County's requirements
 - c. Housekeeping
10. Temporary construction facilities
11. Temporary utilities
12. Safety and first aid procedures
13. Rules and regulations
14. Security procedures
15. Place, date and time for regular progress meetings
16. Completion time for Contract and liquidated damages

1.04 PROGRESS MEETINGS

- A. The County will schedule progress meetings every month and as required by progress of the Work with the first meeting (one) 1-month after the pre-construction meeting. The Contractor will prepare and distribute the meeting minutes within 7 calendar days.
- B. Attendance:
 1. County
 2. Contractor
 3. Subcontractors as appropriate to the agenda
 4. Suppliers as appropriate to the agenda
 5. Others as appropriate

- C. The Contractor's representative is to attend the project meetings and have the authority to act on behalf of the entity represented on field related matters. Contractor's representative is to study previous meeting minutes and current agenda items, in order to be prepared to discuss pertinent topics and provide specific information including but not limited to:
 - 1. Status of submittals and actions necessary to expedite them
 - 2. Status of activities behind schedule and actions necessary to regain the approved schedule
 - 3. Status of materials and equipment deliveries and action necessary to expedite materials and equipment and maintain the approved schedule
 - 4. Status of open RFI's and actions necessary to address them

- D. To the maximum extent practicable, the Contractor is to assign the same personnel to represent the Contractor at Progress Meetings throughout the progress of the Work.

- E. The Contractor is to provide a current Shop Drawing submittal log at each progress meeting.

- F. The Contractor is to provide copies of the updated Progress Schedule at each project meeting in accordance with the General Conditions.

- G. Suggested Agenda:
 - 1. Review and approve minutes from previous meeting
 - 2. Review of Work progress since previous meeting to include current As-Builts
 - 3. Contractor's/Subcontractor's workforce and equipment
 - 4. Progressive As-Built Drawings
 - 5. Surveyor's submittals
 - a. As-Built Asset Attribute Data Table (see Table 01050-2)
 - b. Pipe Deflection Table (see Table 01050-3)
 - c. Gravity Main Table (see Table 01050-4)
 - 6. Field observations, problems and conflicts
 - 7. Construction progress and problems which impede construction schedule
 - 8. Shop Drawing submittal status
 - 9. Requests for Information (RFI) status
 - 10. Change order status
 - 11. Review of off site fabrication and delivery schedules
 - 12. Corrective measures and procedures to regain approved schedule
 - 13. Revisions to construction schedule
 - 14. Job progress and schedule for succeeding work period
 - 15. Coordination of schedules
 - 16. Maintenance of quality standards
 - 17. Review submittal schedule; expedite as required
 - 18. Pending requests for information, changes and substitutions
 - 19. Review proposed changes for effect on construction schedule and completion date
 - 20. Pay application status
 - 21. Other business

H. Revision to Minutes:

1. Unless minutes are challenged, in writing, prior to the next regularly scheduled Progress Meeting, they will be accepted as properly summarizing the discussions and decisions of the meeting.
2. Persons challenging minutes shall reproduce and distribute copies of the challenge to all indicated recipients of the particular set of minutes.
3. Challenge to minutes shall be settled as priority portion of "old business" at next regularly scheduled meeting.

PART 2 - PRODUCTS (NOT USED)

PART 3 - EXECUTION (NOT USED)

END OF SECTION

SECTION 01300

SUBMITTALS

PART 1 - GENERAL

Work completed without approved Shop Drawings and/or samples shall be considered installed at the Contractor's risk.

1.01 SHOP DRAWINGS AND DATA

- A. Shop Drawings defined in the General Conditions, shall complement design and construction Drawings, and shall contain sufficient detail to clearly define all aspects of the Construction. These Drawings shall be complete and detailed.
- B. Contractor and Supplier's catalog sheets, brochures, diagrams, illustrations and other standard descriptive data shall be clearly marked with specification title and numbers to identify pertinent materials, product or models. Delete information which is not applicable to the Work by striking or cross-hatching.
- C. If Shop Drawings show variations from Contract requirements because of standard shop practice or for other reasons, the Contractor shall describe such variations in the letter of transmittal. If acceptable, proper adjustment in the Contract shall be implemented where appropriate. If the Contractor fails to describe such variations, the Contractor shall not be relieved of the responsibility for executing the Work in accordance with the Contract, even though such Drawings have been reviewed.
- D. Data on materials and equipment shall include, without limitation, materials and equipment lists, catalog data sheets, cuts, performance curves, diagrams, verification of conformance with applicable standards or codes, materials of construction and similar descriptive material. Materials and equipment list shall, for each item, give the name and location of the Supplier or manufacturer, trade name, catalog reference, size, finish and all other pertinent data.
- E. For all equipment furnished, the Contractor shall provide a list including the equipment name and address and telephone number of the Supplier's representative and service company so that service and/or spare parts can be readily obtained.
- F. The Contractor will obtain an installation list from suppliers and equipment suppliers who propose to furnish equipment or products for submittal to County/Professional along with the required Shop Drawings. The installation list shall include at least 5 installations where identical equipment has been installed and has been in operation for a period of at least 1-year.

1.02 REVIEW OF SHOP DRAWINGS AND SAMPLES

- A. The County /Professional's review of Shop Drawings, Data, and Samples as submitted by the Contractor will be to determine if the items(s) generally conform(s) to the information in the Contract Documents and is/are compatible with the design concept. The County/Professional's review and exceptions, if any, will not constitute an approval of dimensions, connections, quantities, and details of the material, equipment, device, or item shown.
- B. The review of drawings and schedules will be general, and shall not be construed:
 - 1. As permitting any departure from the Contract Documents
 - 2. As relieving the Contractor of responsibility for any errors, including details, dimensions, and materials
 - 3. As approving departures from details furnished by the County/Professional, except as otherwise provided herein
- C. If the drawings or schedules as submitted describe variations and show a departure from the Contract Documents which the County/Professional finds to be in the interest of the County and to be so minor as not to involve a change in Contract Price or Contract Time, the County/Professional may return the reviewed drawings without noting an exception.
- D. "Approved As Noted": Contractor shall incorporate County/Professional's comments into the submittal before release to manufacturer. The Contractor shall send a letter to the County/Professional acknowledging the comments and their incorporation into the Shop Drawing.
- E. "Amend and Resubmit": Contractor shall resubmit the Shop Drawing to the County/Professional. The resubmittal shall incorporate the County/Professional's comments highlighted on the Shop Drawing.
- F. "Rejected": Contractor shall correct, revise and resubmit Shop Drawing for review by County/Professional.
- G. Resubmittals will be handled in the same manner as first submittals. For resubmittals the Contractor shall direct specific attention, in writing or on resubmitted Shop Drawings, to revisions other than the corrections requested by County/Professional on previous submissions. The Contractor shall make any corrections required by the County/Professional.
- H. If the Contractor considers any correction indicated on the Drawings to constitute a change to the Drawings or Specifications, the Contractor shall give written notice thereof to the County/Professional.

- I. When the Shop Drawings have been completed to the satisfaction of the County/Professional, the Contractor shall carry out the Construction in accordance therewith and shall make no further changes therein except upon written instructions from the County/Professional.
- J. No partial submittals will be reviewed. Submittals not deemed complete will be stamped "Rejected" and returned to the Contractor for resubmittal. Unless otherwise specifically permitted by the County/Professional, make all submittals in groups containing all associated items for:
 - 1. Systems
 - 2. Processes
 - 3. As indicated in specific Specifications Sections
All drawings, schematics, manufacturer's product data, certifications, and other Shop Drawing submittals required by a system specification shall be submitted at one time as a package to facilitate interfaces checking.
- K. Only the County/Professional shall utilize the color "red" in marking Shop Drawing submittals.
- L. Failure to comply with any of the above may result in the rejection of Shop Drawings.

1.03 PRODUCT DATA

- A. Submit not less than 6-copies, unless approved by the County/Professional. Mark each copy to identify applicable products, models, options and other data. Supplement manufacturers' standard data to provide information unique to the Work.

1.04 MANUFACTURERS' INSTRUCTIONS

- A. When required in an individual Specification Section, submit manufacturer's printed instructions for delivery, storage, assembly, installation, start-up, adjusting and finishing, in quantities specified for product data.

1.05 SAMPLES

- A. Submit full range of manufacturers' standard colors, textures and patterns for the County's selection. Submit samples for selection of finishes within 30-days after Award of Contract. All color and finish selections must be submitted by the Contractor in a single submission, properly labeled and identified.
- B. Submit samples to illustrate functional characteristics of the product, with integral parts and attachment devices. Coordinate submittal of different categories for interfacing work.

- C. Submit the number of samples specified in the respective Specification section, but no less than two (2). After review one (1) will be retained by the County. Reviewed samples that may be used in the Work are indicated in the Specification Section.
- D. Samples shall be delivered to the County as directed. The Contractor shall prepay shipping charges on samples. Materials or equipment for which samples are required shall not be used in the Work until approved by the County/Professional.
- E. Samples shall be of sufficient size to clearly illustrate:
 - 1. Functional characteristics of the product, with integrally related parts and attachment devices
 - 2. Full range of color, texture and pattern
 - 3. Each sample shall have a label indicating:
 - a. Name of Project
 - b. Name of Contractor and Subcontractor
 - c. Material or equipment represented
 - d. Place of origin
 - e. Name of product and brand (if any)
 - f. Location in Project
 - g. Specification title and number
 - h. Submittal number
 - i. Note: Samples of finished materials shall have additional marking that will identify them under the finished schedules.
- F. The Contractor shall prepare a transmittal letter, in triplicate (3) for each shipment of samples containing the information required in paragraph herein. The Contractor shall enclose a copy of this letter with the shipment and send a copy of this letter to the County/Professional. Approval of a sample shall be only for the characteristics or use named in such approval and shall not be construed to change or modify any Contract requirements.
- G. Approved samples not destroyed in testing shall be sent to the County or stored at the site of the Work. Approved samples of the hardware in good condition may be incorporated in the Work if requested in writing by the Contractor and approved in writing by the County/Professional. Samples that failed testing or were not approved will be returned to the Contractor at the Contractor's expense, if so requested at time of submission.

1.06 FIELD SAMPLES

- A. Provide field samples of finishes as required by individual Specifications sections. Install the sample completely and finished. Acceptable samples in place may be retained in completed Work.

1.07 DRAWINGS, PRODUCT DATA AND CERTIFICATES

- A. Each letter of transmittal shall identify each and every item transmitted by title, drawing number, revision number and date.

- B. The County generally will not check dimensions, quantities or schedules, except in cases where the information is lacking in the Specifications.
- C. The following is applicable to submitted drawings, data and certificates:
 - 1. Show relation to adjacent structures or materials.
 - 2. Clearly identify field dimensions.
 - 3. Show required dimensions and clearances.
 - 4. Performance characteristic and capabilities shall accompany original Shop Drawing submittals.
 - 5. Wiring diagrams and controls shall accompany original Shop Drawing submittals.
 - 6. Installation instructions shall accompany original Shop Drawing submittals.
 - 7. Each submittal shall identify applicable Standards, such as ASTM number or Federal Specification number.
 - 8. All information not pertinent shall be removed from the submittal, or shall be crossed out.
- D. When resubmission is required, the County/Professional will return only two (2) marked up copies. A third submission from the same manufacturer will not be accepted.

1.08 SUBSTITUTIONS

- A. The substitution requirements of this Section are in addition to the requirements of the General Conditions and Supplementary Conditions.
- B. When a particular product is specified or called for, it is intended and shall be understood that the proposal tendered by the Bidder includes those products in his Bid. Substitutions will only be considered in cases where original materials are unavailable or in an instance where substitute can be proven superior in its planned application
- C. The intent of these specifications is to provide the County with a quality facility without discouraging competitive bidding. For products specified only by reference standards, performance and descriptive methods, without naming manufacturer's products, the Contractor may provide the products of any manufacturer complying with the Contract Documents, subject to the review of product data by the County/Professional as specified herein.
- D. The County/Professional's approval is required for substitutions.
- E. The Contract is based on the materials, equipment and methods described in the Contract Documents.
- F. The County/Professional will consider proposals for substitution of materials equipment and methods only when such proposals are accompanied by full and complete technical data and all other information required by the County/Professional to evaluate the proposed substitution.

- G. Do not substitute materials, equipment or methods unless such substitution has been specifically approved for this Work by the County/Professional in writing. The Contractor must provide a submittal per this Section specifically requesting approval of the substitution. Failure to specifically identify the requested substitution may invalidate approval of a submittal.

1.09 AVAILABILITY OF SPECIFIED ITEMS

- A. Verify prior to bidding that all specified items will be available in time for installation during Construction for orderly and timely progress of the Work.
- B. In the event that specified items will not be available, notify the County/Professional prior to receipt of proposals.

1.10 OPERATING MANUALS

- A. Submit all manuals in accordance with requirements of Divisions 2 through 16 of the Contract Specifications and Section 01700 "Project Closeout."

1.11 WARRANTIES, GUARANTEES AND BONDS

- A. Provide as required by Technical Sections of the Specifications and Sections 01700 "Project Closeout" and Section 01740 "Warranties and Bonds."

1.12 CADD FILES

- A. The Professional's CADD files will be available on a limited basis to qualified firms at the County's prerogative. The procedure for requesting such files is noted elsewhere in these documents and there is a cost associated with handling and reproduction. Recipients are cautioned that these files may not accurately show actual conditions as constructed. Users are responsible to verify actual field conditions.
- B. The Professional's Drawings are to be used only for background information. If the Professional's Drawings are just reproduced and resubmitted (e.g. for ductwork drawings) they will be rejected.
- C. Copies of data furnished by the County/Professional to Contractor or Contractor to County/Professional that may be relied upon are limited to the printed copies (also known as hard copies). Files in electronic media format of text, data, graphics, or other types are furnished only for the convenience of the receiving party. Any conclusion or information obtained or derived from such electronic files will be at the user's sole risk. If there is a discrepancy between the electronic files and the hard copies, the hard copies govern.

- D. Because data stored in electronic media format can deteriorate or be modified inadvertently or otherwise without authorization of the data's creator, the party receiving electronic files agrees that it will perform acceptance tests or procedures within 60-days, after which the receiving party shall be deemed to have accepted the data thus transferred. Any errors detected within the 60-day acceptance period will be corrected by the transferring party.
- E. When transferring documents in electronic media format, the transferring party makes no representations as to long-term compatibility, usability, or readability of documents resulting from the use of software application packages, operating systems, or computer hardware differing from those used by the data's creator.

1.13 PROGRESS PHOTOGRAPHS

- A. Photographs and digital pictures shall be in color. Provide 1 copy of each digital picture on each of three (3) CDs and provide 1 print of each photograph in two (2) separate albums.
- B. Photographs shall be from locations to illustrate the condition of Construction and state of progress adequately.
- C. Provide up to 12 digital photographs of views randomly selected by the County, taken prior to any construction and prior to each scheduled Application for Payment.
- D. Deliver electronic images, prints, and negatives to the County.
- E. Each print shall be single weight paper with glossy finish and the overall dimension shall be 7-1/2-inch x 10-inches (19.05 x 25.4 cm). The print shall be clear, sharp and free of distortion after the enlargement from the negative.
- F. Provide loose-leaf albums for each set of photographs to hold prints with a maximum of 50-leaves per binder.
- G. Each print shall be protected by flexible, transparent acetate or plastic sheet protector leaves with metal reinforced holes. Two (2) extra leaves shall be provided in each binder.
- H. Capture and provide digital, ortho-rectified, true-color, aerial photographs of the complete project site prior to start of Construction and at final completion. A final 6-inch or less ground pixel resolution is required. If using traditional photography, the photos will need to be captured at an appropriate scale and scanned at a high enough dpi to yield a final ground pixel size of 6-inches or less. If captured digitally, a final 6-inches or less ground sample distance is required. The final orthorectified photos shall use a projection of NAD 27, State Plane West and all vertical reference shall be NAVD 88, US feet. All orthophoto mosaics shall meet a final accuracy of plus or minus 5-feet.

- I. Provide a total of four (4) true-color, color balanced orthophoto mosaic prints. Three (3) prints each of the pre and post construction (final completion) orthophoto mosaics, for a total of six (6). Each orthophoto mosaic print shall be on double-weight paper with glossy finish and shall have overall dimensions of 36-inches x 58-inches. Two (2) copies of each of the digital orthophoto mosaics shall be supplied in Geotiff format on disk for each time period (pre and post construction). The final color balanced, true-color orthophoto mosaics will be projected in NAD 27, State Plane West and all vertical reference shall be NAVD 88, US feet and shall meet a final accuracy of plus or minus 5-feet.
- J. The Contractor shall provide before and after photographs of each portion of the site. The below ground facilities shall include all equipment, walls, floor, piping, supports and entrance. At major locations, photographs shall include before, during, and after prints and all prints shall be placed in binders in ascending date order to show the Work as it progresses.
- K. Descriptive Information:
 - 1. Each photograph shall have a permanent title block on the back and shall contain the typed information and arrangement as follows:
 - a. ORANGE COUNTY, FLORIDA
 - b. (ENTER PROJECT NAME)
 - c. BID No. (Enter Bid Number)
 - d. CONTRACTOR: (Name of Contractor)
 - e. DATE: (When photo was taken)
 - f. PHOTO NO.: (Consecutive Numbers)
 - g. PHOTO BY: (Firm Name of Photographer)
 - h. LOCATION: (Description of Location and View)
 - 2. The Contractor shall provide the Professional with a written description of each photograph. This description shall be included in the binders and a copy shall be submitted with the CDs.

1.14 PROJECT RECORD DOCUMENTS

Project Record Documents shall be submitted in accordance with Section 01720 "Project Record Documents" of these specifications.

PART 2 - PRODUCTS (NOT USED)

PART 3 - EXECUTION

3.01 SUBMITTAL PROCEDURES

- A. Article 9 of the General Conditions contains additional provisions regarding submittals.

- B. Preliminary Shop Drawing Data: Within 20-days after the Award of the Contract or before the Pre-Construction Meeting, the Contractor shall submit to the County/Professional a complete listing of manufacturers for all items for which Shop Drawings are to be submitted.
- C. Shop Drawing Submittal Schedule: Within 30-days after the Notice to Proceed, the Contractor shall submit to the County/Professional a complete schedule of Shop Drawings submittals with the respective dates for submission, the beginning of manufacture, testing and installation of materials, supplies and equipment, noting those submittals critical to the progress schedule.
- D. Submittal Log: An accurate updated log of submittals will be maintained by the Contractor and subject to review by the County/Professional at each scheduled progress meeting.
- E. If the Contractor considers any correction indicated on the Drawings to constitute a change to the Contract Drawings or specifications, the Contractor shall give written notice thereof to the County/Professional. This does not constitute a change order until accepted by the County.
- F. Shop Drawing and submittal data shall be reviewed by the County/Professional for each original submittal and first resubmittal; thereafter review time for subsequent resubmittals shall be charged to the Contractor. The Contractor shall reimburse the County for services rendered by the County/Professional at the rate multiplied by the County's Professional multiplier based on the fee schedule provided to the County for this Project. If a County engineer is performing any portion of the review, this fee is based upon the hourly rate of the engineer times the County's multiplier for overhead, benefits, and expenses. The Contractor agrees that the County shall deduct such charges from the Contract Amount by a deductive Change Order.
- G. Contractor Shop Drawing and Sample submittals shall include 5 copies in addition to any other copies that the Contractor wants returned. The County will retain 5 copies of approved submittals.
- H. Identify Project, Project Number, date, dates of previous submittals, Contractor, Sub-Contractors, suppliers with their addresses, pertinent Drawings by sheet and detail number, and Specification Section number, as appropriate. Identify all deviations from the Contract Documents. Provide space for Contractor and Professional review stamps.
- I. Contractor's delivery of Shop Drawings for review shall follow a reasonable sequence, as is necessary to support the dates on the Progress Schedule and avoid an overload of Shop Drawings awaiting review at any one time. Coordinate submittal of related items.

- J. Submit Shop Drawings per the schedule of Shop Drawing submittals, inserted in 1 loose-leaf binder, with tabs and index to the County/Professional. All individual submittal sheets inserted in said binder must be clearly marked and referenced to proper paragraph and subparagraph of specifications. Cross out any items on sheets which constitute information not pertaining to equipment specified. Clearly mark all components that are provided as "optional" by manufacturer. Shop Drawings shall be approved by the Contractor prior to submittal to the County/Professional. Shop Drawings will be reviewed by the County/Professional. After County/Professional approval, reproduce and distribute in accordance with requirements herein.
- K. All submissions of Shop Drawings, brochures and catalog cuts shall be accompanied by a transmittal letter listing the Drawings submitted by number and title.
- L. When engineering calculations and/or professional certification of performance criteria of materials, systems, and/or equipment are required, the County is entitled to rely upon the accuracy and completeness of such calculations and certifications submitted by the Contractor. Calculations, when required, shall be submitted in a neat, clear and in an easy to follow format. Such calculations and/or certifications shall be signed and sealed by a Professional Engineer registered in the State of Florida.
- M. Distribute copies of reviewed submittals to concerned parties. Instruct recipients to promptly report any inability to comply with provisions.
- N. Prior to submission of Shop Drawings and samples, the Contractor shall stamp and sign the submittals. Any submission which, upon examination by the County, shows evidence of not having been thoroughly checked, or is not in compliance with the provisions of this Section will be returned to the Contractor for completion before it will be considered for review.
- O. Notify the County of the need for making any changes in the arrangement of piping, connections, wiring, manner of installation, etc., which may be required by the material or equipment Contractor proposes to supply.
- P. On resubmittals, direct specific attention in writing or on the revised Drawings or sample to revisions other than the corrections required by County on previous submissions.
- Q. All drawings, schematics, manufacturer's product data, certifications and other drawing submittals required for a system specification shall be submitted at one time as a package to facilitate interface checking.
- R. The County will distribute Shop Drawings as follows for the indicated action taken:

SHOP DRAWING SUBMITTAL DISTRIBUTION

Representative Party	No Exception Taken or Make Correction Noted			Rejected or Revise & Resubmit		
	Submittal Transmittal	Shop Drawing	Review Comment Sheet	Submittal Transmittal	Shop Drawing	Review Comment Sheet
Engineer	2 Copies	File Copy	1 Copy	Original	File Copy	1 Copy
Contractor (see Note 1)	2 Copies	1 Copy Each Submittal	1 Copy	1 Copy	All Copies Except Engineers	1 Copy
County	1 Copy	1 Copy Each Submittal	1 Copy	1 Copy	None	1 Copy
Inspector	2 Copies	1 Copy Each Submittal	1 Copy	1 Copy	None	1 Copy
Project Record Data (see Note 2)	1 Copy	1 Copy Each Submittal	1 Copy	1 Copy	None	1 Copy

NOTES:

1. Contractor shall distribute additional copies to Subcontractors as required.
2. Stored by Contractor to be furnished to County upon closeout.

- S. All Shop Drawings shall be accompanied with a transmittal letter providing the following information:
1. Project Title and Contract Number
 2. Date
 3. Contractor's name and address
 4. The number of each Shop Drawing, project data, and sample required
 5. Notification of Deviations from Contract Documents
 6. Submittal Log Number conforming to specification section numbers
 - a. Submit each specification section separately.
 - b. Identify each Shop Drawing item required under respective specification section.
 - c. Identify resubmittal using specification section followed by A (first resubmittal), B (second resubmittal)...etc.

3.02 CONTRACTOR'S REVIEW

- A. Contractor's Responsibility for Coordination: Where the dimension, size, shape, location, capacity or other characteristic affects another item, and where the Contractor selects, fabricates or installs related or adjacent products to be used, the Contractor shall be responsible for coordination of related items. The Contractor shall insure that a proper exchange of information takes place prior to or during preparation of each submittal and that submittals reflect such coordination. The notation "verify" or "coordinate" on the Drawings indicates the necessity for Contractor coordination in the particular instances used.

- B. Contractor's Checking: When checking submittals from Subcontractors and suppliers, the Contractor shall mark all sets, indicating his corrections and comments in blue or green. Copies marked in red may be returned for revision.
- C. The Contractor is responsible to deliver and pick-up all submittals in a timely manner at the County/Professional's designated office. The Contractor is responsible for all related costs and expenses for the transmittal of such submittals.

3.03 COUNTY'S / PROFESSIONAL'S REVIEW

- A. Corrections or comments made on Shop Drawings during review do not relieve the Contractor from compliance with the requirements of Drawings and Specifications. This check is only for review of general conformance with the design concept of this Project and general compliance with information given in Contract Documents. Any substitutions or changes shall be properly noted.
- B. No action will be taken on "rough-in" Shop Drawings for plumbing and electrical connections when the items of equipment are not included in the same submittal.
- C. Review Time:
 - 1. On a normal basis, each submittal will be returned to the Contractor within 15 working days of the date it is received. Some submittals may require additional time.
 - 2. If, for any reason, the above schedule cannot be met, the Contractor will be so informed within a reasonable period and the Schedule of Submittals revised. If the specific submittal affects the critical path, the Contractor shall immediately notify the County/Professional in writing. In the event of separate submittals of individual components of a system, these submittals may be held until all components of the system are submitted, and the Contractor will be so notified.

END OF SECTION

SECTION 01301
PRODUCT SUBSTITUTIONS

PART 1 - GENERAL

1.01 SUMMARY

A. General

1. Base all bids on materials and equipment specified in the Appendix D Orange County Utilities List of Approved Products.
2. Certain types of equipment and kinds of material are described in specifications by means of references to names of manufacturers and vendors, trade names, or catalog numbers.
 - a. When this method of specifying is used, it is not intended to exclude from consideration other products bearing other manufacturer's or vendor's names, trade names, or catalog numbers, provided said products are "or-equals," as determined by County/Professional.
3. Other types of equipment and kinds of material may be acceptable substitutions under the following conditions:
 - a. Or-equals are unavailable due to strike, discontinued production of products meeting specified requirements, or other factors beyond control of Contractor; or,
 - b. Contractor proposes a cost and/or time reduction incentive to the Owner.

1.02 QUALITY ASSURANCE

A. In making request for substitution or in using an approved product, Contractor:

1. Has investigated proposed product, and has determined that it is adequate or superior in all respects to that specified, and that it will perform the function for which it is intended.
2. Will provide same guarantee for substitute item as for product specified.
3. Waives all claims for additional costs related to substitution which subsequently arise.

1.03 DEFINITIONS

- A. Product: Manufactured material or equipment.

1.04 PROCEDURE FOR REQUESTING SUBSTITUTION

A. Substitution shall be considered only:

1. After award of Contract
2. Under the conditions stated herein

- B. Written request through Contractor only.

C. Transmittal Mechanics

1. Follow the transmittal mechanics prescribed for Shop Drawings in Specification Section 01300 "Submittals."
 - a. Product substitution will include in the transmittal letter, either directly or as a clearly marked attachment, the items listed in Paragraph D below.

D. Transmittal Contents

1. Product identification:
 - a. Manufacturer's name
 - b. Telephone number and representative contact name
 - c. Specification Section or Drawing reference of originally specified product, including discrete name or tag number assigned to original product in the Contract Documents.
2. Manufacturer's literature clearly marked to show compliance of proposed product with Contract Documents.
3. Itemized comparison of original and proposed product addressing product characteristics including but not necessarily limited to:
 - a. Size
 - b. Composition or materials of construction
 - c. Weight
 - d. Electrical or mechanical requirements
4. Product experience
 - a. Location of past projects utilizing product.
 - b. Name and telephone number of persons associated with referenced projects knowledgeable concerning proposed product.
 - c. Available field data and reports associated with proposed product.
5. Data relating to changes in construction schedule.
6. Data relating to changes in cost.
7. Samples
 - a. At request of County/Professional.
 - b. Full size if requested by County/Professional.
 - c. Held until substantial completion.
 - d. County/Professional is not responsible for loss or damage to samples.

1.05 APPROVAL OR REJECTION

- A. Written approval or rejection of substitution to be given by the Engineer.
- B. Engineer reserves the right to require proposed product to comply with color and pattern of specified product if necessary to secure design intent.
- C. In the event the substitution is approved, the resulting cost and/or time reduction will be documented by Change Order in accordance with the General Conditions.
- D. Substitution will be rejected if:
 1. Submittal is not through the Contractor with his stamp of approval.
 2. Request is not made in accordance with this Specification Section.

3. In the County/Professional's opinion, acceptance will require substantial revision of the original design.
 4. In the County/Professional's opinion, substitution will not perform adequately the function consistent with the design intent.
- E. Contractor shall reimburse the County for the cost of the evaluation whether or not substitution is approved.

PART 2 - PRODUCTS - (NOT USED)

PART 3 - EXECUTION - (NOT USED)

END OF SECTION

THIS PAGE LEFT BLANK INTENTIONALLY

SECTION 01310
PROGRESS SCHEDULES

PART 1 - GENERAL

1.01 REQUIREMENT

- A. The Contractor will submit precedence method cost loaded Critical Path Method (CPM) Progress Schedules to the County depicting the approach to prosecution and completion of the Work. This requirement includes, but is not limited to the Contractor's approach to Activity cost loading, recovering schedule and managing the effect of changes, substitutions and Delays on Work sequencing.
- B. The Progress Schedule shall show how the Contractor's priorities and sequencing for the Work (or Work remaining) conform to the Contract requirements and the sequences of Work indicated in or required by the Contract Documents; reflect how the Contractor anticipates foreseeable events, site conditions and all other general, local and prevailing conditions that may affect cost, progress, schedule, furnishing and performance of the Work; and show how the Contractor's Means and Methods translate into Activities and logic.
- C. The Progress Schedule will consist of the Initial Submittal, Payment Submittals and Revision Submittals. Upon acceptance by the County, the Initial submittal will become the As-Planned Schedule for the Work. Revision submittals upon acceptance will become the As-Planned Schedule for the Work remaining to be completed as of the submittal date for that Revision.
- D. References to the Critical Path Method (CPM) are to CPM construction industry standards that are consistent with the requirements of this Section.

1.02 GLOSSARY OF TERMS

- A. The following terms, whether or not already defined elsewhere in the Contract Documents, have the following intent and meanings within this Section:
 - 1. Activity Value (Value): That portion of the Contract Price representing an appropriate level of payment for the part of the Work designated by the Activity.
 - 2. As-Planned Schedule: The first, complete Initial Progress Schedule submitted by the Contractor with the intent to depict the entire Work as awarded and accepted by the County or returned as no resubmittal required.
 - 3. Contract Float: Days between the Contractors anticipated date for completion of the Work, or of a specified portion of the Work, if any, and the corresponding Contract Time.

4. CPM Schedule: The Progress Schedule based on the Critical Path Method (CPM) of scheduling. The term Critical Path means any continuous sequence of Activities in the Progress Schedule controlling, because of their sum duration, the Early Date of a pertinent, specified Contract Time.
5. Early/Late Dates: Early/late times of performance, based on CPM calculations, for an Activity in the Progress Schedule. Early Dates will be based on proceeding with all or part of the Work on the date when the corresponding Contract Time commences to run. Late Dates will be based on completing all or part of the Work on the corresponding Contract Time, even if the Contractor plans early completion.
6. Milestones: Key, pre-determined points of progress in the completion of a facility, denoting interim targets in support of the Contract Times. Milestones may pinpoint targets for key excavation and substructure events, significant deliveries, critical path transition from superstructure to piping and electrical rough in and building enclosure. Also, hook-up of mechanical and electrical equipment, availability of power for testing, equipment shakedown, training of County personnel, start -up, Substantial Completion and other events of like import.
7. Official Schedule: The Initial or most recent Revision Submittal accepted by the County or returned as no resubmittal required and the basis for Payment Submittals until another Revision Submittal is submitted and accepted. The accepted Initial Submittal is also the As-Planned Schedule.
8. Payment Submittal: A monthly Progress Schedule update reflecting progress and minor adjustments on the Activities, sequencing and restraints for Work remaining.
9. Total Float: Days by which an activity may slip from its Early Dates without necessarily extending a pertinent Contract Time. Total Float at least equals Contract Float. Total Float may also be calculated and reported in working Days. When an activity is delayed beyond Early Dates by its Total Float it becomes a Critical Path activity and if delayed further will impact a Contract Time.

1.03 QUALITY ASSURANCE

- A. The Contractor may self-perform the Work covered by this Section or employ a Subcontractor, subject to the County's consent. Employment of a scheduling Subcontractor shall not in any way alter or reduce the Contractor's obligations under the Contract Documents.
- B. The Contractor will obtain a written interpretation from the County, if the Contractor believes that the selection of activities, logic ties and/or restraints requires a written interpretation of the Contract Documents. With each submission, the Contractor will point out by specific, written notation, any Progress Schedule feature that may reflect variations from any requirements of the Contract Documents.
- C. It is the Contractor's responsibility to obtain information directly from each Subcontractor and Supplier when scoping their respective Activities, Values, logic ties and restraints.

- D. Neither Acceptance nor Review of any Progress Schedule will relieve the Contractor from the obligation to comply with the Contract Times and any sequence of Work indicated in or required by the Contract Documents and to complete, within the Contract Times, any Work omitted from that Progress Schedule.
- E. Neither Acceptance nor Review of any Progress Schedule will imply approval of any interpretation of or variation from the Contract Documents, unless expressly approved by the County through a written interpretation or by a separate, written notation on the returned Progress Schedule Submittal.

1.04 MILESTONES AND SCHEDULE RECOVERY

- A. The County will select Milestones and Milestone Dates on the basis of the As-Planned Schedule. As the Official Schedule is revised, Milestone Dates will be revised accordingly. Milestone Dates will serve as target dates.
- B. Whenever any Activity slips by 14 or more Days from the Late Date for an activity in the Official Schedule, Milestone Dates selected by the County, or a pertinent Contract Time, the Contractor will deliver a Revision Submittal documenting the Contractor's schedule recovery plan and/or a properly supported request for an extension in the Contract Time. The narrative will identify the Delay and actions taken by the Contractor to recover schedule, whether by adding labor, Subcontractors or construction equipment, activity re-sequencing, expediting of submittals and/or deliveries, overtime or shift Work, and so forth. Activity shortening and overlapping shall be explained as to their basis (and be supported by increases in resources).
- C. Upon evaluation of that Revision Submittal, if the County determines there is sufficient cause, the County may withhold liquidated damages or provide a notice of intent to do so, if schedule is indeed not recovered, and/or may give a notice of default.

1.05 PROGRESS SCHEDULE SOFTWARE

- A. The scheduling software employed by the Contractor to process the Progress Schedule will be the current version of Primavera P6.0®, or Primavera® Contractor 5.0 CPM scheduling software.
- B. If the Contractor intends to use companion schedule reporting, analysis or graphics software tools, the Contractor will furnish to the County descriptive materials and samples describing such software tools.

1.06 NON-PERFORMANCE

- A. The County may refuse to recommend all or any part of any payment, if the Contractor fails, refuses or neglects to provide the required Progress Schedule information on a timely basis. Partial payments without a properly updated Progress Schedule shall be returned to the Contractor as non-conforming.

- B. If justified under the circumstances, the County also may prepare alternate Progress Schedules, as appropriate, and deduct from the Contract Amount all related costs by Change Order and/or take other action commensurate with the breach.

1.07 REPORTS, SCHEDULES AND PLOTS

- A. Schedule Reports will include Activity (ID) code and description, duration, calendar, Early Dates, Late Dates and Total Float. Separate Schedule Reports will tabulate, for each Activity, all preceding and succeeding logic types and lead times, whether CPM Plots displaying logic ties are appended or not.
- B. CPM Schedule Plots will be plotted on a suitable time scale and identify the Contract Times, Critical Paths, phases and work areas on 24-inch x 36-inch or smaller sheets. Activities will be shown on the Early Dates with Total Floats noted by Late Date flags. For Payment and Revision Submittals plot a target comparison based on the current Official Schedule.
- C. The Activity Value report will tabulate Activity code and description and Activity Value, percent complete and earned value as calculated by the scheduling software. Cash flow plots shall be provided showing the monthly and cumulative actual and planned earned values with curves shown for Early and Late Dates in the schedules. For Payment and Revision Schedule submittals, the cash flow curves shall also plot the most current Official Schedule planned earnings curves.
- D. Each submittal shall include listings of all added and deleted activities, logic, constraints, Activity Value changes and update information vs. the previous Progress Schedule submittal. This list may be manually prepared or generated by accessory software that will generate such listings.

1.08 NARRATIVE REQUIREMENTS

- A. The Initial Submittal narrative will describe the Contractor's approach to prosecution of the Work and the basis for determination of activity durations, sequence and logic, including the Contractor's management of the site, e.g., lay down, staging, parking, etc.; Contractor's phasing of the Work; use of crewing and construction equipment; identification of non-work County/Professional's, shifts, weekend Work and multiple calendars applied to activities and an explanation of the basis for restraint dates.
- B. Revision and Payment Submittal narratives will explain any changes to the approach or planning referred to in Paragraph A above on account of any change, delay, schedule recovery, substitution and/or Contractor-initiated revision occurring since the previous submittal.
- C. Each narrative will list the Critical Path Activities and compare Early and Late Dates against Contract Times and Milestone Dates. Narratives shall also recap progress and Days gained or lost vs. the current Official Schedule, and identify delays, their extent and causes.

- D. The Initial Submittal narrative will describe all delays occurring since Contract Award and all pending and anticipated "or equal" and substitution proposals. Payment and Revision Submittal narratives will describe any new delays and shall certify that the Contractor has not been delayed, as of the cut off date, by any acts or omissions of the County, except as otherwise specifically stated.

1.09 ACTIVITY REQUIREMENTS

- A. Separate activities will identify permits, design when included in the Work, construction, Submittal preparation and review (and resubmission and re-review), deliveries (site or storage), testing, start-up, commissioning and Punch List.
- B. Activities will be detailed to the extent required to show the transition of trade Work. Activities will delineate the progression of the Work.
- C. Activities will not combine separate or non-concurrent items of Unit Price or lump sum Work.
- D. Activity durations will equal the Work Days required to sufficiently complete the Work designated by the Activity, (i.e., when finish-to-start successors could start, even if the Activity is not quite 100% complete). Installation Activities will last from 10 to 40 workdays. Submittal review activity durations shall conform to specified timeframes.
- E. Activities will be assigned consistent descriptions and identification codes. Sort codes will group Activities by meaningful schemes.
- F. Activities will be assigned Activity Values as appropriate and needed to reasonably allocate the Contract Amount to the time periods that they will be earned and eligible for payment based on the Progress Schedule and Schedule of Values. Separate pay activities may be used to simplify cost loading of the Progress Schedule. When used, pay activities shall be loaded with the cost of Work that is included, at no cost, in related (generally, concurrent) CPM activities. Pay activities shall not control the rate of progress; however, their start and finish dates shall be consistent with those of their related CPM activities to ensure accurate Early Date and Late Date cash-flow plots.

1.10 FLOAT TOLERANCES AND FLOAT OWNERSHIP

- A. Any Progress Schedule with Early Dates after a Contract Time will yield negative Total and Contract Floats, whether shown/calculated or not. Any Revision Submittal with less than negative 20-days of Float will be returned as "Revise and Resubmit," unless a time extension is requested or the County assesses liquidated damages or gives notice of intent to do so, in the event schedule is not recovered.
- B. Float calculated from the definitions given in this Section supersede any conflicting Float values in any early completion Progress Schedule.

- C. Neither the County nor the Contractor own the Float time, the Project owns the Float time. Neither the County nor the Contractor use of positive Total Float will impact a Contract Completion Date or justify an extension of Contract Time.

1.11 SUBMITTALS

- A. Each Progress Schedule Submittal will consist of a narrative, 5 copies of the required reports and plots and an optical ROM data disk with the Contractor's corresponding schedule and schedule layout files in Primavera ".XER" format.
- B. The County will review Progress Schedule Submittals and return a review copy within 14-days after receipt and the Contractor shall, if required, resubmit within 7-days after return of the review copy.
- C. Requirements for the Initial Submittal:
 - 1. Within 20-days after receipt of Notice to Proceed and prior to commencing Work on the Project, prepare and submit to the County the Initial Submittal of the Progress Schedule for the Work. The Initial Submittal will show the Work as awarded, without delays, Change Orders or substitutions.
 - a. Activity Values will prorate Schedule of Values costs and/or pay items through to Activities. Provide a cross-reference listing with two parts; a part that will list each activity with the respective amounts allocated from each Schedule of Values and Unit Price Item making up the total value of each activity and a second part that will list the Schedule of Values and Unit Price Items with the respective amounts allocated from each activity that make up the total value of each item.
 - 2. After the As-Planned Schedule is established, the County will select Milestones and record the Milestone Early and Late Dates. As the Official Schedule evolves, Milestone Dates will be revised accordingly.
 - 3. If the County refuses to endorse the Initial Submittal (or a resubmission) as "Resubmittal Not Required," the As-Planned Schedule will not be established. In that event, the Contractor will continue to submit Payment and Revision Submittals reflecting progress and the Contractor's approach to remaining Work. The County will rely on the available Payment and Revision Submittals, subject to whatever adjustments it determines appropriate.
- D. Requirements for Payment Submittals:
 - 1. Payment Submittals with progress up to the closing date and updated Early Dates and Late Dates for progress and remaining Activities will be due with each Progress Payment. As-built data will consist of actual dates, percent complete, earned payment, changes, Delays and other significant events occurring before the closing date.
 - 2. Activity percent complete and earned value should indicate a level of completion that corresponds to the Application for Progress Payment for the same period. The earned value should be calculated by the scheduling software as Activity Value times percent complete. Explanation should be provided whenever the cumulative earned value of activities in a Payment Submittal is not within 10% of the value of Work completed as represented in the corresponding Application for Progress for Payment.

3. At the Contractor's option, a Payment Submittal may overlay minor adjustments on activities and sequencing for Work remaining. This excludes Activity re-scoping to reflect Delays, changes, schedule recovery or substitutions.

E. Requirements for Revision Submittals:

1. Revision Submittals will be submitted when necessary because of major changes or delays affecting activities, sequencing or restraints for Work remaining and/or to put forth a schedule recovery plan. Revision Submittals may also be required because of Contractor-initiated re-planning, or when Contractor plans to perform Work ahead or out-of-sequence that will require additional testing or inspection personnel, or when requested by the County when Work is performed out-of-sequence from the current Official Schedule such that the number of Days gained or lost can not be determined or the scheduled dates of completion of the Work in a Payment Submittal are not viewed as reliable.
2. If requesting a time extension, the Revision Submittal should show the impact of the delay after incorporating reasonable mitigation to minimize the impact and illustrate how the number of Days requested time extension was determined. The delay should be determined as the change in the forecast Contract Completion Date(s) resulting solely from delays that entitle the Contractor to a time extension as provided in the General Conditions. Any and all Contractor slippage and delay occurring prior to and concurrent with the delay potentially entitling the Contractor to a time extension shall be incorporated in the Revision and explained such that the concurrent and non-concurrent periods of delay are indicated. If the Contractor does not follow the procedures contained in this Section or, if the Contractor's analysis is not verifiable by an independent, objective evaluation by the County using the electronic files and data furnished by the Contractor, any such extension in Contract Time will not be granted.

F. Retrospective Delay Analysis.

1. If the County/Professional refuses to endorse any Revision Submittal as "Resubmittal Not Required," the Contractor and County will use the latest Official Schedule when evaluating the effect of Delays on Contract Time and/or Contract Price. The procedure to be used will consist of progressively updating the latest Official Schedule at key closing dates corresponding to starting and finishing dates of the delays and/or dates the delays became critical or dates the Critical Path may have changed for other reasons. For each Progress Schedule iteration, slippage between actual Milestone Dates and Initial Milestone Dates will be correlated to Delays occurring solely in that iteration.
2. For each iteration, revisions in Activities, logic ties and restraints affecting Work after the closing date will be included in that Progress Schedule only if they meet any of the following conditions. First, they are Progress Schedule revisions that the County consented to contemporaneously (i.e., before the closing date) in writing. Second, they reflect comments or objections raised by or on behalf of the County and that were actually confirmed by the as-built progress. Lastly, they represent Contractor's schedule recovery plans or other Progress Schedule revisions that were actually confirmed by the as-built progress.

PART 2 - PRODUCTS (NOT USED)

PART 3 - EXECUTION (NOT USED)

END OF SECTION

SECTION 01370
SCHEDULE OF VALUES

PART 1 - GENERAL

1.01 DEFINITION

- A. Schedule of Values: Schedule that divides the Contract Amount into pay items, such that the sum of all pay items equals the Contract Amount for the Work, or for any portion of the Work having a separate specified Contract Amount.

1.02 REQUIREMENT

- A. The Schedule of Values established as provided in the General Conditions will serve as the basis for progress payments and will be incorporated into a form of Application for Payment acceptable to the County. Progress payments on account of Unit Price Work will be based on the number of units completed.
- B. No payment will be made for Work performed on a lump sum contract or a lump sum item until the appropriate Schedule of Values is approved by the County.
- C. The equitable value of Work deleted from a lump sum contract or lump sum item shall be determined from the approved Schedule of Values.

1.03 SUBMITTALS

- A. Submit 3 copies of a Preliminary Schedule of Values within 15-days after the recommended award of the Contract.
- B. Submit 3 copies of a proposed final Schedule of Values within 20-days after receipt of Notice to Proceed as per the General Conditions.
- C. Submit the Schedule of Values, typed, on EJCDC 1910-8-E form or Orange County forms or spreadsheets provided by County. The Contractor's standard form or electronic media printout will be considered for acceptability by the County.
- D. List installed value of each major item of Work and each subcontracted item of Work as a separate line item to serve as a basis for computing values for Progress Payments. Round off values to nearest dollar.
- E. Coordinate listings with the Progress Schedule.
- F. For items on which payments will be requested for stored materials or equipment, list sub-values for cost of stored products with taxes paid.
- G. Submit a sub-schedule for each separate stage of Work specified in Section 01010 "Summary of Work."

- H. The sum of values listed shall equal the total Contract Amount for the Work or the Contract Amount for a part of the Work with a separate Contract Amount provided for by the Contract Documents.
- I. When the County requires substantiating information, submit data justifying line item amounts in question.

1.04 UNIT PRICE CONTRACTS

- A. For unit price contracts, the bid item prices on the Project Bid Schedule shall be used as the basis for the schedule of values. The Contractor shall resubmit the bid item prices in the format described herein, and may, at its option, or if requested by the County, divide the items in the Project Bid Schedule into sub-items to provide a more detailed basis of payment.

1.05 LUMP SUM CONTRACTS

- A. For lump sum contracts, if the Work involves separate facilities, e.g. multiple pump stations, the cost of the Work shall be separated by each facility and into schedule of value items. Break principal subcontract amounts down into these items; The lump sum cost for each facility shall be submitted individually and split into the schedule of values listed in items 1 through 14.
 1. Demolition of existing pump station
 2. Bypass pumping
 3. Wetwell structure, liner, top slab, hatch covers and appurtenances
 4. Valve vault structure, hatch covers and appurtenances, drain piping and appurtenances
 5. Wetwell (mechanical): 316 stainless steel piping and appurtenances, pumps and base plates
 6. Valve vault (mechanical): piping, valves, and appurtenances
 7. Yard piping, fittings, valves, and appurtenances (outside of structures)
 8. Site work and access drive
 9. Chain link fence and gates
 10. Masonry walls and gates
 11. Odor control equipment, piping, monitoring equipment, etc
 12. Generator, fuel storage tank and related piping
 13. Electrical control panel, wiring, and connections
 14. Start-up and testing

PART 2 - PRODUCTS (NOT USED)

PART 3 - EXECUTION (NOT USED)

END OF SECTION

SECTION 01380
AUDIO – VISUAL DOCUMENTATION

PART 1 - GENERAL

1.01 PURPOSE AND DESCRIPTION OF WORK

- A. The purpose of the audio - visual documentation is to provide the County with regularly documented audio - visual records of the Construction process from the existing conditions through final completion.

1.02 PRE-CONSTRUCTION VIDEO REQUIREMENTS INCLUDED

- A. The Contractor shall employ a professional videographer to take a Pre-Construction video of the entire site including the areas of adjacent properties within 100-feet of the limits of Work and shall be made within 30-days of Work beginning. Special attention shall be made to show the existing paved roads, shoulders, signs, and other existing features.
- B. The Contractor shall submit a quality audio-video recording documenting Pre-Construction field conditions for the entire project. When the Work includes construction of water, wastewater, reuse, or other lines in the vicinity of any street or road, the Contractor shall take digital audio-video recordings of existing conditions along both sides of the street or road. The Pre-Construction video shall be submitted to the County and accepted prior to commencing any Work or using any Contractor laydown areas.
- C. Electronic digital photography shall also be used as necessary to record and facilitate resolution of on-site issues through the transmission of electronic photographs by e-mail from the site to the Professional's and County's offices.

PART 2 - PRODUCTS

2.01 AUDIO-VIDEO RECORDING

- A. Each audio-video recording shall be saved on appropriate DVD media viewable on standard DVD players or computer.

- B. Each DVD shall contain the following information and arrangement at the beginning as a title screen:
- Orange County, Florida
 - PROJECT NAME
 - PROJECT NUMBER
 - CONTRACTOR: (Name of Contractor)
 - DATE: (When photo was taken)
 - VIDEO BY: (Firm Name of Videographer)
 - LOCATION: (Description of Location(s) and View(s))
- C. Each DVD recording section shall begin with an audio description of the County's name, Contract name and number, Contractor's name, date and location information such as street name, direction of travel, viewing side, etc.
- D. Information appearing on the video recording must be continuous and run simultaneously by computer generated transparent digital information. No editing or overlaying of information at a later date will be acceptable.
- E. Digital information to appear in the upper left corner shall be as follows:
1. Name of Contractor
 2. Day, date and time
 3. Name of Project & Specification Number
- F. Time must be accurate and continuously displayed on the video record
- G. Written documentation must coincide with the information on the DVD so as to make easy retrieval of locations at a later date.
- H. The video system shall have the capability to transfer individual frames of video electronically into hard copy prints or photographic negatives.
- I. Audio shall be recorded at the same time as the video recording and shall have the same information as on the viewing screen. Special commentary shall be given for unusual conditions of buildings, sidewalks and curbing, foundations, trees and shrubbery, structures, equipment, pavement, etc.
- J. All DVDs and boxes shall bear labels with the following information:
1. DVD Number
 2. County's Name
 3. Date of Recording
 4. Project Name and Number
 5. Location and Standing Limit of Video

2.02 CONSTRUCTION PHOTOGRAPHS

- A. The Contractor shall employ a competent photographer to take construction record photographs periodically during the course of the Work.

- B. Prints: Date imprinted 8-inch x 10-inch high resolution glossy single weight color print paper; 5 sets, bound in 3-ring binders to be provided to the County with each respective Application for Payment and distributed by the County as follows:
1. County (2 sets)
 2. Engineer (1 set)
 3. Contractor (1 set)
 4. Project Record Data (1 set stored by Contractor to be furnished to County upon Closeout)

PART 3 - EXECUTION

3.01 VIDEO VIEWS REQUIRED

- A. Complete coverage shall include all surface features within 100-feet of the Work area to be used by the Contractor and shall be supported by appropriate audio description made simultaneously with video coverage. Such coverage shall include, but not be limited to, all existing driveways, sidewalks, curbs, ditches, roadways, landscaping, trees, culverts, headwalls, and retaining walls, equipment, structures, pavements, manholes, vaults, handrails, etc. located within the work zone. Video coverage shall extend to the maximum height of all structures within this zone.
- B. The video recorder shall take special efforts to point out and provide audio commentary on cracking, breakage, damage, and other defects in existing features.
- C. All video recording shall be done during times of good visibility. No video recording shall be done during periods of visible precipitation, or when more than 10% of the ground area is covered with standing water, unless otherwise authorized by County.
- D. Prior to commencement of audio-video recording, the Contractor shall notify the County in writing within 48-hours of the audio-video recording. The County may provide a designated representative to accompany and observe all video recording operations. Audio-video recording completed without a County Representative present will be unacceptable unless specifically authorized by the County.

3.02 AUDIO-VIDEO REQUIREMENTS

- A. Major Locations:
1. The Contractor shall provide color digital video of each major facility and structures and facilities adjacent to the Construction before construction starts.
 2. All videos shall be recorded with character generator operating with date, time, and location on screen. During video recording, the Contractor shall narrate video explaining what is being shown. All master videos shall be delivered to the County.

3. The audio and video portions of the recording shall maintain viewer orientation. To this end, overall establishing views of all visible house and business addresses shall be used. In areas where the proposed construction location will not be readily apparent to the video recording viewer, highly visible yellow flags shall be placed, by the Contractor, in such a fashion as to clearly indicate the proposed centerline of Construction. When conventional wheeled vehicles are used as conveyances for the recording system, the vertical distance between the camera lens and the ground shall not exceed 10-feet. The camera shall be firmly mounted such that transport of the camera during the recording process will not cause an unsteady picture.
4. All video recording shall be done during time of good visibility. No video recording shall be done during precipitation, mist or fog. The recording shall only be done when sufficient sunlight is present to properly illuminate the subjects of recording and to produce bright, sharp video recordings of those subjects.
5. The average rate of travel during a particular segment of coverage shall be directly proportional to the number, size and value of the surface features within that construction area's zone of influence. The rate of speed in the general direction of travel of the vehicle used during taping shall not exceed 44-feet per minute.

3.03 PHOTOGRAPHS

- A. A minimum of 3 views (top, upstream, and downstream) each shall generally be taken prior to backfilling pipelines or structures. Photographs shall be provided for:
 1. Utility conflicts/relocations
 2. Manholes
 3. Pump stations
 4. Boring and jacking
 5. Directional drilling pipe entrance and exit
 6. Valve installation
 7. Air release valve installation
 8. Fire hydrant assembly
- B. Photo Identification
 1. Name of Project
 2. Name of Structure
 3. Orientation of View
 4. Date & Time of Exposure
 5. Film numbered identification of exposure

END OF SECTION

SECTION 01400
QUALITY CONTROL

PART 1 - GENERAL

1.01 SITE INVESTIGATION AND CONTROL

- A. Contractor shall verify all dimensions in the field and check field conditions continuously during construction. Contractor shall be solely responsible for any inaccuracies built into the Work due to Contractor's failure to comply with this requirement.
- B. Contractor shall inspect related and appurtenant Work and report in writing to County any conditions which will prevent proper completion of the Work. Failure to report any such conditions shall constitute acceptance of all site conditions, and any required removal, repair, or replacement caused by unsuitable conditions shall be performed by the Contractor at Contractor's sole cost and expense.

1.02 INSPECTION OF THE WORK

- A. The Work shall be conducted under the general observation of representatives of the County acting on behalf of the County to ensure strict compliance with the requirements of the Contract Documents. Such inspection may include mill, plant, shop, or field inspection, as required. The County shall be permitted access to all parts of the Work, including plants where materials or equipment are manufactured or fabricated. Inspection by the County are in addition to the inspections required of Contractor by his QC Representatives.
- B. The presence of the County, however, shall not relieve the Contractor of the responsibility for the proper execution of the Work in accordance with all requirements of the Contract Documents. Compliance is a duty of the Contractor, and said duty shall not be avoided by any act or omission on the part of the County. Further, no requirement of this Contract may be waived or modified except by change order or formal (written) substitution approval.
- C. All materials and articles furnished by the Contractor shall be subject to rigid inspection, and no materials or articles shall be used in the Work until they have been inspected and accepted by the County. No Work shall be backfilled, buried, cast in concrete, hidden, or otherwise covered until it has been inspected. Any Work so covered in the absence of inspection shall be subject to uncovering. Where uninspected Work cannot be uncovered, such as in concrete cast over reinforcing steel, all such Work shall be subject to demolition, removal, and reconstruction under proper inspection and no additional payment will be allowed therefore.

- D. The Contractor is responsible for the Quality of his own work and shall designate a qualified individual, to be approved by the County, who will ensure that all work is performed in strict accordance with the Contract Documents. This quality representative shall inspect the work for the Contractor and provide to the County and the Contractor a report outlining all work accomplished, all inspections, and all testing performed for all days when work is performed. The objective of this report is to provide "Objective Evidence of Compliance" by the Contractor with the requirements of the Contract.

1.03 TIME OF INSPECTION AND TESTS

- A. Samples and testing required under these Specifications shall be furnished and prepared in ample time for the completion of the necessary tests and analyses before said articles or materials are to be used. Except as otherwise provided in the Contract Documents, performance of the required tests will be by the Contractor and all costs therefore will be borne by the Contractor at no cost to the County. Whenever the Contractor is ready to backfill, bury, cast in concrete, hide, or otherwise cover any Work under this Contract, the County shall be notified not less than 24-hours in advance to request inspection before beginning any such Work of covering. Failure of the Contractor to notify the County at least 24-hours in advance of any such inspections shall be reasonable cause for the County to order a sufficient delay in the Contractor's schedule to allow time for such inspection, any remedial, or corrective work required, and all costs of such delays, including its impact on other portions of the Work, shall be borne by the Contractor.

1.04 SAMPLING AND TESTING

- A. When not otherwise specified, all sampling and testing shall be in accordance with the methods prescribed in the current standards of the ASTM, as applicable to the class and nature of the article or materials considered. However, the County reserves the right to use any generally accepted system of inspection which, in the opinion of the County, will ensure the County that the quality of the workmanship is in full accord with the Contract Documents.
- B. Any waiver of any specific testing or other quality assurance measures, whether or not such waiver is accompanied by a guarantee of substantial performance as a relief from the specified testing or other quality assurance requirements as originally specified, and whether or not such guarantee is accompanied by a performance bond to assure execution of any necessary corrective or remedial work, shall not be construed as a waiver of any technical or qualitative requirements of the Contract Documents.
- C. Notwithstanding the existence of such waiver, the County shall reserve the right to make independent investigations and tests as specified in the following paragraph and, upon failure of any portion of the Work to meet any of the qualitative requirements of the Contract Documents, shall be reasonable cause for the County to require the removal or correction and reconstruction of any such Work.

- D. In addition to any other inspection or quality assurance provisions that may be specified, the County shall have the right to independently select, test, and analyze, at the expense of the County, additional test specimens of any or all of the materials to be used. Results of such tests and analyses shall be considered along with the tests or analyses made by the Contractor to determine compliance with the applicable specifications for the materials so tested or analyzed provided that wherever any portion of the Work is discovered, as a result of such independent testing or investigation by the County which fails to meet the requirements of the Contract Documents, all costs of such independent inspection and investigation and all costs of removal, correction, reconstruction, or repair of any such Work shall be borne by the Contractor.

1.05 RIGHT OF REJECTION

- A. The County shall have the right at all times and places to reject any articles or materials to be furnished hereunder which, in any respect, fail to meet the requirements of the Contract Documents, regardless of whether the defects in such articles or materials are detected at the point of manufacture or after completion of the Work at the site. If the County or inspector, through an oversight or otherwise, has accepted materials or Work which is defective or which is contrary to the Contract Documents, such material, no matter in what stage or condition of manufacture, delivery, or erection, may be rejected by County.
- B. Contractor shall promptly remove rejected articles or materials from the site of the Work after notification or rejection.
- C. All costs of removal and replacement of rejected articles or materials, as specified herein, shall be borne by the Contractor.
- D. If the Contractor fails to remove or replace defective work after notification to do so, the County may have the work removed and replaced by others and deduct all costs from the Contractor's pay requests.

1.06 TESTING LABS

- A. All geotechnical testing laboratory services for field testing will be paid by the County. The lab(s) shall function as independent lab(s) and report independently to the County and the Contractor. The test lab(s) may not approve or allow any deviation from the Contract Documents.

PART 2 - PRODUCTS (NOT USED)

PART 3 - EXECUTION (NOT USED)

END OF SECTION

THIS PAGE LEFT BLANK INTENTIONALLY

SECTION 01410
TESTING AND TESTING LABORATORY SERVICES

PART 1 - GENERAL

1.01 DESCRIPTION

A. Scope of Work:

1. County will employ, and pay for services of an Independent Testing Laboratory to perform Testing specifically indicated on the Contract Documents or specified in the Specifications and may at any other time elect to have materials and equipment tested for conformity with the Contract Documents.
2. Contractor shall cooperate with the laboratory to facilitate the execution of its required services.
3. Employment of laboratory by County shall in no way relieve Contractor's obligations to perform the Work of the Contract.

B. Related Requirements Described Elsewhere:

1. Conditions of the Contract.
2. Respective section of Specifications: Certification of products.
3. Each Specification section listed: Laboratory tests required, and standards for testing.

1.02 LABORATORY DUTIES: LIMITATIONS OF AUTHORITY

A. Submit 5 copies of inspection reports to the County. The reports shall include the following components:

1. Project title and County's project number
2. Testing laboratory name and address
3. Date of report issuance
4. Name and signature of field technician
5. Date of inspections, sampling, and/or testing
6. Record of weather conditions
7. Identification of product tested and associated specification section
8. Testing location
9. Description of testing performed
10. Observations made regarding compliance with the Contract Documents

B. Laboratory is not authorized to:

1. Release, revoke, alter, or enlarge on requirements of Contract Documents
2. Approve or reject any portion of Work
3. Perform any duties of the Contractor

1.03 CONTRACTOR'S RESPONSIBILITIES

A. Cooperate with County's personnel; provide access to Work and manufacturer's operations.

- B. Secure and deliver to the County adequate representational samples of materials proposed to be used and which require testing.
- C. Provide to the County the preliminary design mix proposed to be used for concrete, and other materials mixes which require control by the testing laboratory.
- D. Materials and equipment used in the performance of work under this Contract are subject to inspection and testing at the point of manufacturer or fabrication. Standard specifications for quality and workmanship are indicated in the Contract Documents. The County may require the Contractor to provide statements or certificates from the manufacturers and fabricators that the materials and equipment provided by them are manufactured or fabricated in full accordance with the standard specifications for quality and workmanship indicated in the Contract Documents. All costs of this testing and providing statements and certificates shall be a subsidiary obligation of the Contractor, and no extra charge to the County shall be allowed on account of such testing and certification.
- E. Contractor shall not have direct contact with laboratory or laboratory personnel. All testing shall be coordinated through County.
- F. Furnish incidental labor and facilities:
 - 1. To provide access to Work to be tested.
 - 2. To obtain and handle samples at the Project site or at the source of the product to be tested.
 - 3. To facilitate inspections and tests.
 - 4. For storage and curing of test samples.
- G. Notify County sufficiently in advance of operations to allow for laboratory assignment of personnel and scheduling of tests. When tests or inspections cannot be performed after such notice, reimburse County for laboratory personnel and travel expenses incurred due to Contractor's negligence.
- H. Employ and pay for the services of the same or a separate, equally qualified independent testing laboratory to perform additional inspections, sampling and testing required for the Contractor's convenience.
- I. If the test results indicate the material or equipment complies with the Contract Documents, the County shall pay for the cost of the testing laboratory. If the tests and any subsequent retests indicate the materials and equipment fail to meet the requirements of the Contract Documents, the Contractor shall pay for the laboratory costs directly to the County or the total costs shall be deducted from any payments due to the Contractor.

PART 2 - PRODUCTS (NOT USED)

PART 3 - EXECUTION (NOT USED)

END OF SECTION

SECTION 01516
COLLECTION SYSTEM BYPASS

PART 1 - GENERAL

1.01 SCOPE OF WORK

- A. The Work covered by this section consists of providing all temporary bypassing to perform all operations in connection with the flow of wastewater around pipe segment(s) or pump stations. The purpose of bypassing is to prevent wastewater overflows and provide continuous service to all wastewater customers. The Contractor will maintain wastewater flow in the construction area in order to prevent backup and/or overflow and provide reliable wastewater service to the users of the wastewater system at all times.

1.02 SUBMITTALS

- A. Prior to implementation of any bypass, the Contractor will submit and receive County acceptance of a bypass plan. The Contractor will submit to the County a comprehensive written plan for approval and acceptance that describes the intended bypass for the maintenance of flows during construction. The Contractor will also provide a sketch showing the location of bypass pumping equipment for each pump station or line segment(s) around which flows are being bypassed. The plan will include proposed tanker(s), pump(s), bypass piping, backup plan and equipment, work schedule, monitoring log for bypass pumping, monitoring plan of the bypass pumping operation, and maintenance of traffic plan.

PART 2 - PRODUCTS

2.01 GENERAL

- A. The Contractor will provide and maintain adequate equipment, piping, tankers, and other necessary appurtenances in order to maintain continuous and reliable wastewater service in all wastewater lines as required for construction. The Contractor will have tankers, backup pump(s), piping, and appurtenances ready to deploy immediately.
- B. All piping will be designed to withstand at least twice the maximum system pressure or a minimum of 50-psi, whichever is greater.
- C. When bypassing a pump station, 1 back-up pump equal to the primary unit will be provided by the Contractor. Bypass pumps must comply with sound requirements.

PART 3 - EXECUTION

3.01 GENERAL

- A. The Contractor shall have all materials, equipment and labor necessary to complete the repair, replacement, or rehabilitation on the job site prior to isolating the gravity main segment, manhole, or pump station. The Contractor will demonstrate that the temporary bypass pumping system is in good working order and is sufficiently sized to successfully handle flows by performing a test run for a period of 24-hours prior to beginning the Work.

3.02 TRAFFIC CONSIDERATIONS

- A. The Contractor shall locate bypass pumping suction and discharge lines so as to not cause undue interference with the use of streets, private driveways, and alleys, to include the possible temporary trenching of piping at critical intersections. Additional traffic maintenance requirements are found in Section 01570 "Maintenance of Traffic".

3.03 BYPASS OPERATION

The County shall accept the bypass plan prior to implementation of the bypass operation. Contractor will plug off and pump down the sewer manhole or line segment in the immediate work area and will maintain the wastewater system so that surcharging does not occur. A successful 3-day test period shall be performed during normal County workdays (no weekend).

- A. Where Work requires the line to be blocked after normal working hours and bypass pumping is being used, the Contractor shall be responsible for monitoring the bypass operation 24-hours per day, 7-days per week. Any electronic monitoring in lieu of on-site monitoring must be detailed in the comprehensive written plan and approved by the County.
- B. The Contractor shall ensure that no damage will be caused to private property as a result of bypass pumping operations. The Contractor will complete the Work as quickly as possible and satisfactorily pass all tests, inspections, repair all deficiencies prior to discontinuing bypassing operations, and returning flow to the sewer manhole or line segment.
- C. During bypassing, no wastewater will be leaked, dumped, or spilled in or onto, any area outside of the existing wastewater system.
- D. The Contractor shall immediately notify the County should a sanitary sewer overflow occur and take the necessary action to clean up and disinfect the spillage to the satisfaction of the County or other governmental agency. If sewage is spilled onto public or private property, the Contractor will wash down, clean up and disinfect the spillage to the satisfaction of the County and or other governmental agencies.

- E. When bypassing a pump station, 1 back-up pump equal to the primary unit shall be required. Bypass pumps shall have a maximum rating of 55 decibels for sound attenuation.
- F. The Contractor shall cease bypass operations and return flows to the new and/or existing sewer when directed by the County. When bypass operations are complete, all bypass piping shall be drained into the wastewater system prior to disassembly.

3.04 CONTRACTOR LIABILITY

- A. The Contractor shall be responsible for all required pumping, equipment, piping, and appurtenances to accomplish the bypass and for any and all damage that results directly or indirectly from the bypass pumping equipment, piping and/or appurtenances. The Contractor shall also be liable for all County personnel labor and equipment costs, penalties and fines resulting from sanitary sewer overflows. It is the intent of these specifications to require the Contractor to establish adequate bypass pumping as required regardless of the flow condition.

END OF SECTION

1

THIS PAGE LEFT BLANK INTENTIONALLY

SECTION 01560
EROSION AND SEDIMENTATION CONTROL

PART 1 - GENERAL

1.01 WORK INCLUDED

- A. The Work specified in this Section consists of designing, providing, maintaining and removing temporary erosion and sedimentation controls as necessary to protect the Work and prevent sedimentation from the Contractor's activities from entering water bodies or enter other parts of the County's or other property owners sites outside the Construction limits.
- B. Temporary erosion controls include, but are not limited to; grassing, mulching, netting, watering and reseeded on-site surfaces and soil and borrow area surfaces, and providing interceptor ditches at end of berms and at those locations which will ensure that erosion during Construction will be either eliminated or maintained within acceptable limits as established by the regulatory agencies having jurisdiction.
- C. Temporary sedimentation controls include, but are not limited to; silt dams, traps, barriers, and appurtenances at the foot of sloped surfaces which will ensure that sedimentation pollution will be either eliminated or maintained within acceptable limits as established by the regulatory agencies having jurisdiction.

1.02 REQUIREMENTS

- A. The Contractor is responsible for providing effective temporary erosion and sediment control measures during Construction or until final controls become effective.
- B. The Contractor shall be responsible for filing Notice of Intent for Construction Activities with regulatory agencies (SJRWMD, SFWMD, and FDEP) as required by law, if thresholds are expected to be exceeded.
- C. The areas of unstabilized soil cover shall be minimized at all times to limit erosion and sedimentation.

1.03 SUBMITTALS:

- A. The Contractor shall prepare and submit an Erosion and Sedimentation Control Plan (Stormwater Pollution Prevention Plan) for County review and approval. The Plan shall be in effect throughout the Construction duration.

PART 2 - PRODUCTS

2.01 EROSION CONTROL

- A. Seed: Scarified Argentine Bahia.
- B. Sod: Bermuda grass, Argentine Bahia grass, Pensacola Bahia grass or St. Augustine. Grassing and Sodding Materials: As specified in Section 981 FDOT Specification for Road & Bridge Construction.
- C. Netting: Polypropylene mesh netting 5/8-inch x 3/4-inch (16 x 19mm) mesh with interwoven curlex fibers as manufactured by American Excelsior Company or equal. Netting: Fabricated of material in conformance with Section 985 FDOT Specification for Road & Bridge Construction.

2.02 SEDIMENTATION CONTROL

- A. Bales: Clean, synthetic hay type. Minimum dimensions of 14-inch by 18-inch by 36-inches at the time of placement.
- B. Netting: Fabricated of material in conformance with Section 985 FDOT Specification for Road & Bridge Construction.
- C. Sediment Control Fencing (Silt Fencing): As manufactured by American Excelsior Company or equal.
- D. Filter stone: Crushed stone conforming to Florida Department of Transportation Specifications.
- E. Concrete block: Hollow, non-load bearing type.
- F. Concrete: Exterior grade not less than 1-inch thick.
- G. Turbidity Barriers: Floating or staked as required.

PART 3 - EXECUTION

3.01 TEMPORARY EROSION CONTROL

- A. See Section 02578 "Solid Sodding."

3.02 SEDIMENTATION CONTROL

- A. Install and maintain silt fences and dams, traps, barriers, and appurtenances as shown on the approved descriptions and working Drawings. Replace deteriorated hay bales and dislodged filter stone. Repair portions of any devices damaged at no additional expense to the County.

- B. Install all sediment control devices in a timely manner to ensure the control of sediment. At sites where exposure to sensitive areas is likely, complete installation of all sediment control devices before starting earthwork.
- C. Use approved temporary erosion control features to correct conditions that develop during Construction that were not foreseen when the Erosion and Sedimentation Control Plan was first approved.

3.03 PERFORMANCE

- A. Should any of the temporary erosion and sediment control measures employed by the Contractor fail to produce results that comply with the requirements of the Regulatory agency having jurisdiction, the County or the Professional, the Contractor shall immediately take whatever steps necessary to correct the deficiency at its own expense to protect the Work and any adjacent property to the site, as well as to prevent contamination of any river, stream, lake, tidal waters, reservoir, canal or other water impoundments.
- B. The side slope areas with unstabilized or unprotected soil cover shall be minimized at all times to limit erosion and sedimentation.
- C. Incorporate permanent erosion control features into the Project at the earliest practical time.
- D. Remove temporary erosion and sedimentation controls when the Work is complete and in accordance with the Erosion and Sedimentation Control Plan (Stormwater Pollution Prevention Plan) and the Notice of Intent for Construction Activities filed with regulatory agencies.

3.04 MAINTENANCE OF EROSION AND CONTROL FEATURES

- A. Provide routine maintenance of permanent and temporary erosion control features, at no expense to the County, until the Project is complete and accepted.

END OF SECTION

1

THIS PAGE LEFT BLANK INTENTIONALLY

SECTION 01570
MAINTENANCE OF TRAFFIC

PART 1 - GENERAL

1.01 DESCRIPTION

This section includes identifying safety hazards and then furnishing all necessary labor, materials, tools, and equipment including, but not limited, to signs, barricades, traffic drums, cones, flashers, construction fencing, flag persons, warning devices, temporary pavement markings, delineators, etc., to control vehicular and pedestrian traffic through and adjacent to the project area. These measures and actions shall be taken to safely maintain the accessibility of public and construction traffic by preventing potential construction hazards. This Work shall also include all costs associated with the erecting, maintaining, moving, adjusting, cleaning, relocating, and storing the materials necessary to ensure safe movement of vehicular and pedestrian traffic throughout the project area. The Contractor may request that the County approve the detouring of traffic around the Construction area if it is in the best interest of public safety and the County. Detouring shall be limited to normal construction hours and two-way traffic patterns shall be re-established at the end of each workday.

1.02 REQUIREMENTS

- A. Traffic planning and control for the maintenance and protection of pedestrian and vehicular traffic affected by the Contractor's Work includes, but is not limited to:
 - 1. Construction and maintenance of any necessary detour equipment and facilities.
 - 2. Providing necessary facilities for access to residences and businesses.
 - 3. Furnishing, installing, and maintenance of traffic control and safety devices (e.g. signage, barricades, barriers, message boards, etc.), and flag persons as appropriate during Construction.
 - 4. Control of water runoff, dust and any other special requirements for safe and expeditious movement of traffic.
- B. Planning, maintenance and control of traffic shall be provided at the Contractor's expense. The Contractor will bear all expense of maintaining the vehicle and pedestrian traffic throughout the work area.
- C. The Contractor will ensure all personnel involved in traffic control are properly trained and capable of communicating with the public during closures and detours. The Contractor may be required to hire off-duty uniformed police officers, in addition to flag persons, to direct and maintain traffic on heavily traveled thoroughfares on which traffic is subject to delays or detours caused by the Contractor's operations. Locations and conditions requiring such uniformed police officers shall be as directed by the County.

- D. The Contractor will remove temporary equipment and facilities when no longer required, restore grounds to original, or to specified conditions.

1.03 SUBMITTALS

- A. Submit at Contractor's own expense a Traffic Control Plan for approval by the County. Sequence the Work in a manner that will minimize disruption of vehicular and pedestrian access through and around the construction area.
- B. The Traffic Control Plan will detail procedures and protective measures proposed by the Contractor to provide for protection and control of traffic affected by the Work consistent with the following applicable standards:
 - 1. Standard Specifications for Road and Bridge Construction, latest edition including all subsequent supplements issued by the Florida Department of Transportation, (FDOT Spec.).
 - 2. Manual of Traffic Control and Safe Practices for Street and Highway Construction, Maintenance and Utility Operations, FDOT.
 - 3. Right-of-Way Utilization Regulations, Orange County, Florida, latest edition.
- C. All references to the respective agencies in the above referenced standards shall be construed to also include the municipality as applicable for this Work.
- D. The Traffic Control Plan will be signed and sealed by a Professional Engineer registered in the state of Florida and shall include proposed locations and time durations of the following, as applicable:
 - 1. Pedestrian and public vehicular traffic routing.
 - 2. Lane and sidewalk closures, other traffic blockage and lane restrictions and reductions anticipated to be caused by construction operations. Show and describe the proposed location, dates, hours and duration of closure, vehicular and pedestrian traffic routing and management, traffic control devices for implementing pedestrian and vehicular movement around the closures, and details of barricades.
 - 3. Location, type and method of shoring to provide lateral support to the side of an excavation or embankment parallel to an open travel-way.
 - 4. Allowable on-street parking within the immediate vicinity of worksite.
 - 5. Access to buildings immediately adjacent to worksite.
 - 6. Driveways blocked by construction operations.
 - 7. Temporary traffic control devices, temporary pavement striping and marking of streets and sidewalks affected by construction
 - 8. Temporary commercial and industrial loading and unloading zones.
 - 9. Construction vehicle reroutes, travel times, staging locations, and number and size of vehicles involved.

- E. Obtain and submit prior to erection, or otherwise impacting traffic, all required permits from all authorities having jurisdiction, including Orange County Public Works, if applicable.

PART 2 - PRODUCTS

2.01 MATERIALS AND EQUIPMENT

- A. The Contractor will furnish barricades, warning signs, delineators, pilot cars and other traffic control materials and equipment in accordance with the Manual of Uniform Traffic Control Devices for Streets and Highways published by the United States Government Printing Office.

2.02 FLAG PERSONS

- A. All flag persons used on this Project will adhere to the following requirements:
 1. Any person acting as a flag person on this Project will have attended a training session taught by a Contractor's qualified trainer before the start date of this Contract.
 2. The Contractor's qualified trainer will have completed a "Flag person Train the Trainer Session" in the 5-years previous or before the start date of this Contract and will be on file as a qualified flag person trainer.
 3. The flag person trainer's name and Qualification Number will be furnished by the Contractor at the Pre-Construction meeting. The Contractor will provide all flag persons with the Flag Person Handbook and will observe the rules and regulations contained therein. This handbook will be in the possession of all flag person while flagging on the Project.
 4. Flag persons will not be assigned other duties while working as authorized flag persons.
 5. Any person replacing flag person for break shall have the same training.

PART 3 - EXECUTION

3.01 NOTIFICATIONS

- A. The Contractor will notify individual owners, owner's agents, and tenants of buildings adjacent to worksite in writing, with copies to the county, 72-hours in advance of any disruption to their access to those buildings and/or use of public ways adjacent to the buildings or prohibiting the stopping and parking of vehicles.
- B. Before closing any vehicle or pedestrian thoroughfare, the Contractor will give written notice to the County. Notice will be given no less than 72-hours in advance of the proposed closure, or as may be otherwise provided in the accepted Traffic Control Plan, so that the final approval of such closings can be obtained at least 48-hours in advance.

- C. The Contractor is responsible for notifying Fire and Ambulance Departments whenever roads are impassable.
- D. The Contractor will immediately notify the County of any vehicular or pedestrian safety or efficiency problems incurred as a result of the construction of the Project.

3.02 GENERAL TRAFFIC CONTROL

- A. The Contractor will sequence and plan construction operations and will generally conduct Work in such a manner as not to unduly or unnecessarily restrict or impede normal traffic.
- B. Unless otherwise provided, all roads within the limits of the Work will be kept open to all traffic by the Contractor. The Contractor will keep the portion of the project being used by public traffic, whether it is through or local traffic, in such condition that traffic will be adequately accommodated.
- C. The Contractor will be responsible for installation and maintenance of all traffic control devices and requirements for the duration of the construction period. Necessary precautions for traffic control will include, but not be limited to, warning signs, signals, lighting devices, markings, barricades, canalizations and hand signaling devices.
- D. The Contractor will provide and maintain in a safe condition temporary approaches or crossings and intersections with trails, roads, streets, businesses, parking lots, residences, garages and farms.
- E. The Contractor will provide emergency access to all residences and businesses at all times. Residential and business access will be restored and maintained at all times outside of the Contractor's normal working hours.
- F. Traffic is to be maintained on one section of existing pavement, proposed pavement, or a combination thereof. Alternating one-way traffic may be utilized and limited to a maximum length of 500-feet during construction hours. Lane width for alternating one-way traffic will be kept to a minimum width of 10-feet, or as directed by the County.
- G. Travel lanes and pedestrian passways will be drained and kept reasonably smooth, and in a suitable condition at all times in order to provide minimum interference to traffic consistent with the prosecution of the Work.
- H. The Contractor will make provisions at all "open cut" street crossings to allow for free passage of vehicles and pedestrians, either by bridging or other temporary crossing structures. Such structures will be of adequate strength and proper construction and will be maintained by the Contractor in such a manner as not to constitute an undue traffic hazard.

- I. The Contractor will keep all signs in proper position, clean, and legible at all times. Care will be taken so that weeds, shrubbery, construction materials, equipment, and soil are not allowed to obscure any sign, light, or barricade. Signs that do not apply to construction conditions should be removed or adjusted so that the legend is not visible to approaching traffic.
- J. The County may determine the need for, and extent of, additional striping removal and restriping.
- K. Excavated material, spoil banks, construction materials, equipment and supplies will not be located in such a manner as to obstruct traffic, as practicable. The Contractor will immediately remove from the site all demolition material, exercising such precaution as may be directed by the County. All material excavated shall be disposed of so as to minimize traffic and pedestrian inconvenience and to prevent damage to adjacent property.
- L. During any suspension, the Contractor will make passable and open to traffic such portions of the Project and/or temporally roadways as directed by the County for accommodation of traffic during the anticipated period of suspension. Passable conditions will be maintained until issuance of an order for the resumption of construction operations. When Work is resumed, the Contractor will replace or renew any Work or materials lost or damaged because of such temporary use in every respect as though its prosecution had been continuous and without interferences.

3.03 TEMPORARY SHORING

- A. Use shoring to maintain traffic when it is necessary to provide lateral support to the side of an excavation or embankment parallel to an open travel-way. Provide shoring when a theoretical 2:1 or steeper slope from the bottom of the excavation or embankment intersects the existing ground line closer than 5-feet (1.5 m) from the edge of pavement of the open travel-way.
- B. The Contractor will furnish, install, and remove sheeting, shoring, and bracing necessary to maintain traffic at locations shown on the Traffic Control Plan and other locations determined during construction.

END OF SECTION

THIS PAGE LEFT BLANK INTENTIONALLY

SECTION 01580
PROJECT IDENTIFICATION AND SIGNS

PART 1 - GENERAL

1.01 REQUIREMENTS INCLUDED

- A. The Contractor shall furnish, install, and maintain all sign materials including sign posts, weighted stands, brackets, any required mounting hardware, and miscellaneous materials required for temporary signs for the purpose of:
 - 1. Project Identification.
 - 2. Informational signs to direct traffic
 - 3. On-site safety signs as appropriate for the Work
- B. Remove temporary signs on completion of Construction prior to obtaining Certificate of Occupancy and Substantial Completion.
- C. Allow no other signs to be displayed without written approval of the County.

1.02 SUBMITTALS

- A. Submit complete Shop Drawings identifying locations, material, layout, sign content, font type and size, and sample colors. Make sign and lettering to scale, clearly indicating condensed lettering if used. The sign details will be submitted to the County for approval prior to fabrication.
- B. Submit method of erection to include materials, fasteners, and other items to assure compliance with the requirements for wind pressures as required by the authorities having jurisdiction.
- C. Submit signs in accordance with any details provided in the Drawings.
- D. Prior to erection obtain and submit all required permits from the authorities having jurisdiction.

1.03 PROJECT IDENTIFICATION SIGN

- A. Provide 1 painted sign at the site, or at each end of the Work if a linear project, or at each of the separate sites of Work, if applicable. The sign will be not less than 32-square feet area, with a minimum dimension of 4-feet and painted graphics with content to include:
 - 1. Title of Project
 - 2. Orange County Government name and logo
 - 3. Names and titles of the Board of County Commissioners, County Administrator, Director of Orange County Utilities Department, the Consulting Engineer, and the Contractor

- B. Erect on the site at a lighted location of high public visibility, adjacent to main entrance to site, as approved by the County. The sign must be located 5-feet from all rights-of-way and 20-feet from all property lines.

1.04 INFORMATIONAL SIGNS

- A. All signs and other traffic control devices shall conform to the requirements for shape, color, size, and location as specified in the latest Manual on Uniform Traffic Control and Safe Streets and Highways and the Florida Manual of Traffic Control and Safe Practices for Street and Highway Construction, Maintenance and Utility Operations. Information as to the above may be obtained from FDOT Division engineers.

PART 2 - PRODUCTS

2.01 SIGN MATERIALS

- A. Structure and Framing: New construction grade lumber, structurally adequate and suitable for exterior application and specified finish.
- B. Sign Panels: New A-B Grade, exterior type, APA DF plywood with inset hardwood edges and mitered corners, standard large sizes to minimize joints.
 - 1. Thickness: As required by standards to span framing members, to provide even, smooth surface without waves or buckles, minimum 3/4-inch.
- C. Rough Hardware: Galvanized steel, of sizes and types to enable sign assemblies to resist wind pressures as required by the authorities having jurisdiction but not less than a wind velocity of 50-mph.
 - 1. Use minimum 1/2-inch diameter button head carriage bolts to fasten sign panels to supporting structures. Bolt heads to be painted to match sign face.
- D. Paint: Exterior quality, as specified in Division 9 or as a minimum as specified herein.
 - 1. Primer and finish coat: exterior, semi-gloss, alkyd enamel.
 - 2. Colors for structure, framing, sign surfaces, and graphics: As shown on the Drawings or as selected by the County.
- E. Safety Sign Number Tags
 - 1. Removable aluminum or galvanized steel, with 4-inch high, blue numerals and steel tag hooks.

PART 3 - EXECUTION

3.01 PROJECT IDENTIFICATION SIGN

- A. Install project identification signs within 10-days of the Notice to Proceed date. Failure to erect the signs may be reason to delay approval of the initial Application for Payment.

- B. Paint exposed surfaces of supports, framing, and surface material; one (1) coat of primer and two (2) coats of finish paint.
- C. Set signs plumb and level and solidly brace as required to prevent displacement during the Construction period. If mounted on posts, sink posts 3-feet to 4-feet below grade, leaving a minimum of 8-feet of each post above grade for mounting the sign.
- D. Install informational signs at a height for optimum visibility, on ground mounted poles or attached to temporary structural surfaces.

3.02 MAINTENANCE

- A. Maintain signs and supports in a neat, clean condition; repair damages to structure, framing, or sign.
- B. Relocate informational signs as required by the progress of the Work.
- C. Poorly maintained, defaced, damaged, or dirty signs shall be replaced, repaired, or cleaned without delay.
- D. Special care must be taken to ensure that construction materials and dust are not allowed to obscure the face of a sign.
- E. Signs not in effect shall be covered or removed.

3.03 REMOVAL

- A. Remove signs, framing, supports, and foundations at Substantial Completion of the Work.
- B. Leave areas clean and patch as required to remove any traces of temporary signs.

END OF SECTION

1

THIS PAGE LEFT BLANK INTENTIONALLY

SECTION 01590
CONSTRUCTION FIELD OFFICE

PART 1 - GENERAL

1.01 SECTION INCLUDES

- A. Contractor provision of temporary utilities to include electricity, lighting, internet connectivity, heat, ventilation, telephone service, water, and sanitary facilities.
- B. Contractor provision of temporary controls to include barriers, enclosures and fencing, and water control.
- C. Contractor provision of temporary facilities to include access roads, parking, and temporary buildings.
- D. Contractor provision of field offices for the County.
- E. Restrictions on the use of existing adjacent facilities.

1.02 TEMPORARY ELECTRICITY

- A. Provide and pay for power service required for Construction and testing from local utility source.
- B. Provide temporary electric feeder from existing electrical service at location as directed by utility company. Power consumption will not disrupt the County's need for continuous service. Coordinate with the County before making taps or disturbing existing service.
- C. Provide separate metering and pay for cost of energy used until substantial completion. If electric service is turned over to and paid for by the County prior to substantial completion, reimburse the County for energy used up to substantial completion.
- D. Provide power outlets for Construction operations, with branch wiring and distribution boxes located as required. Provide OSHA approved flexible power cords as required.
- E. Contractor-installed permanent convenience receptacles may be used during Construction.

1.03 TEMPORARY LIGHTING

- A. Provide and maintain adequate lighting for Construction operations to achieve a minimum lighting level of one (1) watt/sq ft.
- B. Provide and maintain two (2) foot-candle lighting to exterior staging and storage areas after dark for security purposes.

- C. Provide and maintain 0.25-watt/sq ft H.I.D. lighting to interior Work areas after dark for security purposes.
- D. Provide branch wiring from power source to distribution boxes with lighting conductors, pigtails, and lamps as required.
- E. Maintain lighting and provide routine repairs.
- F. Permanent building lighting may be used during Construction.

1.04 TEMPORARY HEAT AND COOLING

- A. Provide and pay for heating and cooling as required to maintain specified conditions for Construction operations or as required for proper conduct of operations included in the Work.
- B. Prior to operation of permanent equipment for temporary purposes, verify that installation is approved for operation, equipment is lubricated and temporary filters are in place. Provide and pay for operation, maintenance, and regular replacement of filters and worn or consumed parts.
- C. Maintain minimum ambient temperature of 50°F and maximum relative humidity of 50% in areas where Construction is closed in and final finishes are to be placed, unless indicated otherwise in specifications.

1.05 TEMPORARY VENTILATION

- A. Ventilate enclosed areas to assist cure of materials, to dissipate humidity, and to prevent accumulation of dust, fumes, vapors, or gases.

1.06 TEMPORARY WATER SERVICE

- A. Provide, maintain, and pay for suitable quality water service required for Construction operations. Coordinate with the County if water supply is not separately metered. Pay all costs and expenses associated with such use.
- B. Extend branch piping with outlets located so water is available by hoses with threaded connections.

1.07 TEMPORARY SANITARY FACILITIES

- A. Provide and maintain required facilities and enclosures on-site. Maintain daily in clean and sanitary condition. Adjacent County office building toilet facilities are not to be used by Contractor.

1.08 BARRIERS

- A. Provide barriers to prevent unauthorized entry to Construction areas and to protect existing facilities and adjacent properties from damage from Construction operations.

- B. Provide barricades required by governing authorities for public rights-of-way.
- C. Provide protection for plant life designated to remain. Replace damaged plant life.
- D. Protect non-owned vehicular traffic, stored materials, site and structures from damage.

1.09 FENCING

- A. Unless directed otherwise in other sections of the Contract Documents, provide a 6-foot high fence completely around Construction site; provided with hinged vehicular and pedestrian gates with locks. Fencing will be galvanized, 2-inch mesh, chain link with solid top rail. Provide line posts and end posts as needed to maintain stretched and uniform fencing with no sags.
- B. Fencing plan will be approved by the County for each phase of the project. Submit fencing layout diagram prior to the Pre-Construction meeting.
- C. Provide visual fabric barrier at least 6-foot high on all fencing separating parking areas from Construction activities. Submit barrier fabric for approval before starting fencing. Barrier fabric will be capable of retaining physical integrity and color during the entire Construction period.

1.10 ACCESS ROADS

- A. Provide and maintain uninterrupted public access to existing buildings. Construction activities will not interfere with access. If Contractor fails to maintain public access after 2 written notices within a 24-hour period, the County reserves the right to correct such situation and back charge the Contractor.
- B. Construct and maintain temporary roads accessing public thoroughfares to serve Construction area.
- C. Extend and relocate access roads as Work progress requires. Provide detours necessary for unimpeded traffic flow.
- D. Provide and maintain access to fire hydrants, free of obstructions.
- E. Designated existing on-site roads may be used for Construction traffic. Repair or restore any damaged areas caused as a result of Construction activity. Such repair will be to a like-new condition.

1.11 PARKING

- A. Provide temporary surface parking areas to accommodate Construction personnel.
- B. Do not allow Construction vehicle parking on existing pavement unless approved by County.

1.12 FIELD OFFICES (FOR UTILITIES DEPARTMENT)

- A. Promptly after starting Work, the Contractor will provide and maintain 1 field office for the use of the County until Substantial Completion.
- B. The field offices will be an appropriate size required for the use of the County, as well as contain two offices and three desks. The field office structure will be a minimum of 10-feet x 40-feet. The layout of the County's field office will include adequate space to hold project meetings (minimum seating for 15).
- C. Installation of the field offices will meet all local codes and ordinances. The Contractor will as a minimum install the structures on a level, well-drained area. Structures will be designed and installed to resist 130-mph winds or applicable State of Florida code, whichever is more stringent.
- D. The field offices will be provided with structurally sound and safe steps and landings for each door. The doors will have secure locks. Construct appropriate walkway and landings. Construct covers over each door that extends 3-feet from the building and the full width of the landing.
- E. The field offices will be designated as a "No Smoking Area."
- F. The windows will be arranged for cross ventilation with screens.
- G. Provide air conditioning and heating systems with thermostat control.
- H. Provide electric power for the duration of the Work.
- I. The Contractor will provide the following with the field office, at a minimum:
 - 1. Electric lights (fifty (50) foot-candles at desktop height) and power supply outlets.
 - 2. When available, provide high-speed Internet access to all desks for the duration of the Work.
 - 3. Acceptable toilet facilities with appropriate signage that meet all of the local and State health codes and regulations.
 - 4. Fire extinguisher (Halon type, minimum 4 lb. capacity).
 - 5. Water coolers, bottled water and paper cups.
 - 6. Tables for viewing the Project Drawings.
 - 7. Standard office supplies.
 - 8. Weekly janitorial services.

1.13 SPECIFIC REQUIREMENTS FOR THE FIELD OFFICES

Provide the following for the exclusive use of the County: (Unless otherwise noted, the quantity should be sufficient for the duration of the Work.)

- A. Office Furnishings: The furniture will be delivered and placed as directed by the County.
- B. Desks: Flat top, double pedestal, with one box and one file drawer in each pedestal, 60-inches by 30-inches. Total quantity will be three (3).

- C. Chairs: Three (3) office-type chairs, adjustable heights, on rollers, with armrests.
- D. Conference Table and Chairs: One (1) table (3-feet by 8-feet minimum), scratch and stain resistant and 15 meeting-type chairs.
- E. Drawing Table: Two (2) plywood or standard drawing tables, 3-feet by 6-feet, with all required appurtenances and 2 extended height stools suitable for use at the drawing tables.
- F. Printer: One(1) - All in one color inkjet printer capable of printing, scanning and coping Ledger, Legal and Letter sizes. Standard interfaces shall include Hi-Speed USB 2.0, Wireless (802.11b/g/n), Ethernet. Minimum requirements include: 35 page automatic document feeder, printing 20 color copies per minute at 6000 x 1200 dpi resolution, scan resolution 2400 x 2400 dpi, flat bed document glass size Ledger (11" x 17") with standalone copy features, minimum of 250 sheet input capacity cassettes and 2 additional complete set of ink cartridges. Brother MFC-J6710DW or equal. Printers to be retained by the County.. All warranties, maintenance, servicing and sufficient appropriate ink/toner cartridges and paper for the duration of the Work.
- G. One (1) each refrigerator, microwave, coffee machine, and toaster oven.
 - 1. Provide Internet connection in each of the four offices in the field trailer. The connection shall be at least 5.0 Mbps of download speed or greater. Provide office with a wireless network 802.11 n with minimum of 8 concurrent users in addition to the network requirements. Wireless network shall allow additional portable computers to gain internet access within the office.
- H. File Cabinets, Storage, Bookcases:
 - 1. Three (3) Lateral Files: HON 600 Series, or equal, 42-inch wide, four-drawer.
 - 2. Two (2) steel vertical, hanging mobile plan stands, with approximately 12-hanging clamps. Provide all required clamps, of sufficient length to hold the Contract Drawings.
 - 3. Storage: Two (2) industrial grade steel cabinets, locking handles, 36-inches wide by 18-inches deep by 72-inches high.
 - 4. Bookcases: Three (3) HON metal bookcases, or equal, 34-1/2-inches wide by 12-5/8-inches deep by 71-inches high, color to be selected by the Engineer.
- I. Miscellaneous Field Supplies:
 - 1. One (1) minimum/maximum digital thermometer, with batteries for the duration of the Work.
 - 2. One (1) rain gauge.

1.14 REMOVAL OF TEMPORARY UTILITIES, FACILITIES, AND CONTROLS

- A. Remove all temporary utilities, equipment, facilities, and materials prior to submitting Final Application for Payment.
- B. Remove temporary underground installations to minimum depth of 2-feet and re-grade site.
- C. Clean and repair damage caused by installation or use of temporary Work.

- D. Restore any existing facilities used during Construction to original condition, unless otherwise directed in other sections of Contract Documents. Restore existing landscaping, drainage, paving, etc. to an "as-was" condition, unless otherwise directed in other sections of Contract Documents.

PART 2 - PRODUCTS (NOT USED)

PART 3 - EXECUTION (NOT USED)

END OF SECTION

SECTION 01610
DELIVERY, STORAGE AND HANDLING

PART 1 - GENERAL

1.01 DESCRIPTION

- A. This Section specifies the general requirements for the delivery, handling, storage and protection for all items required in the construction of the Work.
- B. Deliver, handle and store products in accordance with manufacturer's recommendations and by methods and means that will prevent damage, deterioration, and loss including theft and protect against damage from climatic conditions. Control delivery schedules to minimize long-term storage of products at the site and overcrowding of construction spaces. In particular, provide delivery/installation coordination to ensure minimum holding or storage times for products recognized to be flammable, hazardous, easily damaged, or sensitive to deterioration, theft and other sources of loss. Damaged or defective items, in the opinion of the County, will be replaced at no cost to the County.

1.02 REQUIREMENTS

- A. The Contractor is responsible for all material, equipment and supplies sold and delivered to the County under this Contract until final inspection of the Work and acceptance thereof by the County.
- B. All materials and equipment to be incorporated in the Work will be handled and stored by the Contractor before, during and after shipment in a manner to prevent warping, twisting, bending, breaking, chipping, rusting, and any injury, theft or damage of any kind whatsoever to the material or equipment.
- C. All materials and equipment, which in the opinion of the County, have become so damaged as to be unfit for the use intended or specified, will be promptly removed from the site of the Work, and the Contractor will receive no compensation for the damaged materials or equipment or for its removal.
- D. In the event any such material, equipment and supplies are lost, stolen, damaged or destroyed prior to final inspection and acceptance, the Contractor will replace same without additional cost to the County.

1.03 DELIVERY

- A. Transport and handle items in accordance with manufacturer's instructions.

- B. The County and the Contractor's project superintendent must be on-site to accept all deliveries shipped directly to the job site. If the project superintendent is not present for a delivery, that delivery may be rejected by the County. If any delivery is rejected due to non-availability of the Contractor's project superintendent, delivery shall be rescheduled at no additional cost to the County.
- C. Schedule delivery to reduce long-term on-site storage prior to installation and/or operation. Under no circumstances will materials or equipment be delivered to the site more than 1-month prior to installation without written authorization from the County.
- D. Coordinate deliveries in order to avoid delay in, or impediment of, the progress of the Work.
- E. Schedule deliveries to the site not more than 1-month prior to scheduled installation without written authorization from the County.
- F. Coordinate delivery with installation to ensure minimum holding time for items that are hazardous, flammable, easily damaged or sensitive to deterioration.
- G. All items delivered to the site will be unloaded and placed in a manner that will not hamper the Contractor's normal construction operation or those of Subcontractors and other Contractors and will not interfere with the flow of necessary traffic.
- H. Deliver products in undamaged condition, in manufacturer's original containers or packaging, with identifying labels intact and legible. Maintain packaged materials with seals unbroken and labels intact until time of use.
- I. Immediately on delivery, inspect shipments with the County to ensure compliance with requirements of Contract Documents and accepted submittals, and that products are properly protected and undamaged. If the Contractor does not notify the County regarding the delivery and the County rejects any part of the delivery, there will be no additional cost to the County for the material to be returned. For items furnished by others (i.e. County), perform inspection in the presence of the County. Provide written notification to the County of any problems.
- J. Promptly remove damaged material and unsuitable items from the job site, and promptly replace with material meeting the specified requirements, at no additional cost to the County.

1.04 STORAGE AND HANDLING

- A. Provide equipment and personnel to handle products by methods recommended by the manufacturer to prevent soiling or damage to products or packaging, with seals and labels intact and legible.
- B. The Contractor is responsible for securing a location for on-site storage of all material and equipment necessary for completion of the Work. The location and storage layout will be submitted to the County at the Pre-Construction conference.

- C. Manufacturer's storage instructions will be carefully studied by the Contractor and reviewed with the County. These instructions will be carefully followed and a written record of this kept by the Contractor.
- D. All material delivered to the job site will be protected from dirt, dust, dampness, water, and any other condition detrimental to the life of the material from the date of delivery to the time of installation of the material and acceptance by the County.
- E. When required or recommended by the manufacturer, the Contractor will furnish a covered, weather protected storage structure providing a clean, dry, non-corrosive environment for all mechanical equipment valves, architectural items, electrical and instrumentation equipment, and special equipment to be incorporated into this Project.
- F. Arrange storage in a manner to provide easy access for inspection. Make periodic inspections of stored products to assure that products are maintained under specified conditions and free from damage or deterioration.
- G. Should the Contractor fail to take proper action on storage and handling of equipment supplied under this Contract within 7-days after written notice to do so has been given, the County retains the right to correct all deficiencies noted in previously transmitted written notice and deduct the cost associated with these corrections from the Contract Amount. These costs may be comprised of expenditures for labor, equipment usage, administrative, clerical, engineering, and any other costs associated with making the necessary corrections.

1.05 SPECIFIC STORAGE AND HANDLING

(Additional specific storage and handling requirements may be found in the specification sections addressing the material requirements.)

- A. All mechanical and electrical equipment and instruments subject to corrosive damage by the atmosphere if stored outdoors (even though covered by canvas) will be stored in a weather tight building to prevent damage. The building may be a temporary structure on the site or elsewhere, but it must be satisfactory to the County. The building will be provided with adequate ventilation to prevent condensation. Maintain temperature and humidity within range required by manufacturer.
 - 1. All equipment will be stored fully lubricated with oil, grease and other lubricants unless otherwise instructed by the manufacturer. Mechanical equipment to be used in the Work, if stored for longer than 90-days, will have the bearings cleaned, flushed and lubricated prior to testing and startup, at no extra cost to the County.
 - 2. Moving parts will be rotated a minimum of once weekly to ensure proper lubrication and to avoid metal-to-metal "welding." Upon installation of the equipment, the Contractor will start the equipment, at least half load, once weekly for an adequate period of time to ensure that the equipment does not deteriorate from lack of use.

3. Lubricants will be changed upon completion of installation and as frequently as required thereafter during the period between installation and acceptance. New lubricants will be put into the equipment at the time of acceptance. Prior to acceptance of the equipment, the Contractor will have the manufacturer inspect the equipment and certify that its condition has not been detrimentally affected by the long storage period. Such certifications by the manufacturer will be deemed to mean that the equipment is judged by the manufacturer to be in a condition equal to that of equipment that has been shipped, installed, tested and accepted in a minimum time period. As such, the manufacturer will guaranty the equipment equally in both instances. If such a certification is not given, the equipment will be judged to be defective. It will be removed and replaced at the Contractor's expense.
 4. Electric motors provided with heaters will be temporarily wired for continuous heating during storage. Upon installation of the equipment, the Contractor will start the equipment, at least half load, and once weekly for an adequate period of time to insure that the equipment does not deteriorate from lack of use.
- B. Store loose granular materials on solid flat surfaces in a well-drained area. Prevent mixing with foreign matter.
 - C. Cement and lime will be stored under a roof and off the ground and will be kept completely dry at all times.
 - D. Brick, block and similar masonry products will be handled and stored in a manner to minimize breakage, chipping, cracking and spilling to a minimum.
 - E. Precast Concrete will be handled and stored in a manner to prevent accumulations of dirt, standing water, staining, chipping or cracking.
 - F. All structural and miscellaneous steel and reinforcing steel will be stored off the ground or otherwise to prevent accumulations of dirt or grease, and in a position to prevent accumulations of standing water and to minimize rusting. Beams will be stored with the webs vertical.
 - G. Metals will be stored dry, all under cover and vented to prevent build-up of humidity, all off ground to provide air circulation.
 - H. Lumber will be stacked to provide air circulation. Store materials for which maximum moisture content is specified in an area where moisture content can be maintained.
 - I. Gypsum wallboard systems will be stored to protect all metal studs, furring, insulation boards, batts, accessories and gypsum board to prevent any type of damage to these materials. Rusted material components, damp or wet insulation or gypsum boards will not be accepted.

- J. Acoustical materials will be delivered to the job site in unbroken containers labeled and clearly marked. Materials will not be removed from containers until ready to install, but will be stored in dry area with cartons neatly stacked. Before installation, acoustical board will be stored for not less than 24-hours in the Work area at the same temperature and relative humidity.
- K. Linear items will be stored in dry area with spacers to provide ventilation. Stack linear items to prevent warping, complying with manufacturer's instructions.
- L. Paints and other volatile materials will be stored within approved safety containers. No glass jugs will be permitted. Storage areas will be equipped with not less than 2 fire extinguishers (CO2 type) sufficient to discharge a distance of 25-feet when fully charged and have current tags. No other building materials will be stored in this area. Used rags will be removed daily. Clean rags will be stored in metal closed containers.

PART 2 - PRODUCTS (NOT USED)

PART 3 - EXECUTION (NOT USED)

END OF SECTION

1

THIS PAGE LEFT BLANK INTENTIONALLY

SECTION 01650
PUMP STATION START-UP AND TESTING

PART 1 - GENERAL

1.01 SCOPE OF WORK

- A. The Contractor will conduct preliminary testing of pump station facilities, products and equipment. If the preliminary field tests disclose any items furnished under this Contract which do not comply with the requirements of the Contract Documents, the Contractor shall make all changes, adjustments and replacements required prior to Start-up Demonstration and Acceptance Testing.
- B. The Contractor shall arrange qualified instruction by the manufacturer's representative for the County's designated operating and maintenance personnel in operation, adjustment and maintenance of products, equipment and systems.
- C. The Contractor shall furnish all labor, fuel, energy, lubrication, water, and all other materials, equipment, tools and instruments necessary for the Start-up Demonstration and Acceptance Testing unless otherwise specified.
- D. The startup and final check out shall demonstrate and ensure to the County the complete operating pump station system. The Contractor shall provide documentation certifying proper installation, testing and operation of all prescribed equipment and systems.

PART 2 - PRODUCTS (NOT USED)

PART 3 - EXECUTION

3.01 PUMP STATION START-UP TESTING AND INSPECTION

- A. The Contractor shall notify the County at least 10 normal working days prior to start-up.
- B. The following shall have been successfully met prior to pump station start-up:
 - 1. A walk through letter of acceptance received
 - 2. All wire checks conducted
 - 3. Video of gravity main inspections completed
 - 4. FDEP Clearances received
 - 5. FDEP placard for fuel tank if applicable
 - 6. Completed Appendix B "Pump Station Start-Up" form
 - 7. Certified Boundary Survey and As-Built Survey
 - 8. The Contractor shall conduct preliminary testing of equipment prior to start-up testing and make all changes, adjustments and replacements required; and

9. The liner(s) shall meet the testing requirements of the Contract Documents and a letter or form signed by the County that testing was witnessed and approved.
- C. The intent of the start-up testing is for the Contractor to demonstrate to the County that the Work will function as a complete and operable system under normal as well as emergency operating conditions and the pump station is ready for acceptance.
- D. The Contractor shall furnish all labor, fuel, energy, lubrication, water and all other materials, equipment, tools, and instruments necessary for pump station start-up testing and inspection. All material used shall be listed on the Appendix D "List of Approved Products." All required certification letters, spare parts and supplies shall be provided to the County. Listed below is a partial checklist of requirements to be met.
1. The Contractor shall coordinate startup activities with the County, the manufacturer's representatives and Subcontractors. A factory representative knowledgeable in the mechanical and electrical equipment furnished shall inspect and supervise a start-up of their respective equipment. A minimum of 1 full business day shall be provided for the testing. Additional time may be necessary due to faulty or incomplete Work. Upon satisfactory completion of the equipment testing and inspection, the factory representative(s) shall issue the required manufacturer's warranty certificates.
 2. Initiate start-up of each system in accordance with the operation and maintenance manual. Demonstrate that all of the components of a system are operating under their own controls as designated without overheating or overloading any parts and without objectionable vibration as determined by the County.
 3. Observe the system operation and make adjustments as necessary to optimize the system performance. Coordinate with County for any adjustments desired or operational problems requiring debugging.
 4. All functions of the pump station mechanical and electrical equipment shall be tested and inspected for operation and workmanship. All equipment shall be properly installed and meet the design performance requirements.
 5. The pumps shall be flow tested at the pump station start-up to verify their performance meets the design requirements and the manufacturer's pump curve.
 6. Furnish 2 printed copies and 3 electronic copies in Acrobat "pdf" format of the Operation and Maintenance Manual for the pump station to the County.
 7. A pump station start-up report shall be completed. See Appendix B "Pump Station Start-Up Report Form."
 8. The Contractor shall bear the entire expense of rectifying Work installed.
 9. The Contractor shall furnish the County with a written certification signed by the Manufacturer's representative that the equipment has been properly installed and lubricated, is in accurate alignment, is free from undue stress imposed by piping or mounting bolts, and has been operated under full load conditions and that satisfactory operation has been obtained.

E. Re-testing

If the start-up testing does not meet the requirements, the deficiencies shall be corrected and the testing procedure will be rescheduled again.

F. FDEP fuel tank placard

When a generator fuel tank is required, the Contractor shall submit documentation that the facility has passed the FDEP fuel tank compliance inspection and that a properly completed "Storage Tank Facility Registration Form" has been submitted to the Florida Departmental of Environmental Protection including all applicable fees. The placard shall be provided to the County.

G. Acceptance

1. The pump station shall be accepted based on the pump station functioning as a complete and operable system under normal as well as emergency operating conditions, the approved construction documents have been met and any deficiencies that were observed and noted have been corrected.
2. The Contractor shall ensure all fuel, lubrication, and all other materials for operation are replenished.

END OF SECTION

1

THIS PAGE LEFT BLANK INTENTIONALLY

SECTION 01700
PROJECT CLOSEOUT

PART 1 - GENERAL

1.01 DESCRIPTION

The term "Project Closeout" is defined to include requirements near the end of the Contract Time, in preparation for Substantial Completion acceptance, occupancy by the County, release of retainage, final acceptance, final payment, and similar actions evidencing completion of the Work. Time of closeout is directly related to "Substantial Completion"; therefore, the time of closeout may be either a single period for the entire Work or a series of time periods for individual elements of Work that has been certified as substantially complete at different dates. This time variation, if any, will be applicable to the other provisions of this section.

1.02 SCOPE OF WORK

- A. This Section specifies administrative and procedural requirements for project closeout, including but not limited to:
 - 1. Final Cleaning
 - 2. Substantial Completion
 - 3. Final Acceptance

1.03 RELATED WORK

- A. Drawings and general provisions of the Contract, including General and Supplementary Conditions and other Division 1 Specification Sections, apply to this Section.
- B. Closeout requirements for specific construction activities are included in the appropriate Sections in Divisions 2 through 16.
- C. Section 01720 "Project Record Documents"
- D. Section 01740 "Warranties and Bonds"

1.04 PREREQUISITES FOR SUBSTANTIAL COMPLETION.

When the Contractor considers the Work as substantially complete, submit to the County a written notice stating so and requesting an inspection to determine the status of completion. The Contractor will attach to the notice a list of items known to be incomplete or yet to be corrected. Complete the following before requesting the County's inspection for certification of substantial completion.

- A. In the progress payment request that coincides with or is the first request following, the date substantial completion is claimed, show 100% completion or list incomplete items, the value of incomplete Work, and reasons for the Work being incomplete. Inspection procedures include supporting documentation for completion as indicated in these Contract Documents.
- B. Submit a statement showing an accounting of changes to the Contract Sum.
- C. Submit specific warranties, workmanship/maintenance bonds, maintenance agreements, final certifications and similar documents in accordance with Section 01740 "Warranties and Bonds."
- D. Obtain and submit lien releases enabling the County's full, unrestricted use of the Work and access to services and utilities.
- E. Consult with County before submitting Record Documents in accordance with Section 01720 "Project Record Documents."
- F. Submit Operation and Maintenance Manuals.
- G. Make final changeover of permanent locks. Submit keys and keying schedule.
- H. Deliver tools, spare parts, extra stock, and similar items.
- I. Complete final cleaning requirements necessary for Substantial Completion.

1.05 FINAL CLEANING.

Complete the following cleaning operations prior to Substantial Completion or Owner occupancy.

- A. Remove from job site all tools, surplus materials, construction equipment, storage sheds, debris, waste and temporary services.
- B. Clean the site, including landscape development areas, of rubbish, litter and other foreign substances. Sweep paved areas broom clean; remove stains, spills and other foreign deposits. Rake grounds that are neither paved nor planted, to a smooth even-textured surface.
- C. Structures:
 - 1. Visually inspect exterior surfaces and remove all traces of soil, waste materials, smudges and other foreign matter.
 - 2. Remove all traces of splashed materials from adjacent surfaces.
 - 3. Ensure exterior surfaces have a uniform degree of cleanliness.
 - 4. Visually inspect interior surfaces and remove all traces of soil, waste materials, smudges and other foreign matter.
 - 5. Remove paint droppings, spots, stains and dirt from finished surfaces.
 - 6. Remove labels that are not permanent labels.
 - 7. Clean transparent materials, including mirrors and glass in doors and windows. Remove glazing compound and other substances that are noticeable vision-obscuring materials. Replace chipped or broken glass and other damaged transparent materials.

8. Clean exposed exterior and interior hard-surfaced finishes to a dust-free condition, free of stains, films and similar foreign substances. Leave concrete floors broom clean.
9. Wipe surface of mechanical and electrical equipment. Remove excess lubrication and other substances. Clean light fixtures and lamps.
10. Clean permanent filters of ventilating systems and replace disposable filters if units were operated during construction. Clean ducts, blowers and coils if units were operated without filters during construction.

1.06 OPERATION AND MAINTENANCE MANUALS

- A. The Contractor will submit the proposed format, content and tab structure for all Operating and Maintenance Manuals for the County's review and approval. The tab structure for Operating and Maintenance Manuals will follow specification division format as accepted by the Construction Specification Institute. After the County approves the proposed format, content, and tab structure for the Operating and Maintenance Manuals, the Contractor will create and deliver 5 complete sets.
- B. Operation and Maintenance documentation is required for each piece of mechanical, electrical, communications, instrumentation and controls, pneumatic, hydraulic, conveyance, and special construction. If required by the technical specifications, provide Operation and Maintenance documentation for any other product not listed in the foregoing.
- C. The requirements of this Section are separate, distinct and in addition to product submittal requirements that may be established by other Sections of the Specifications. Owner's manuals, manufacturer's printed instructions, parts lists, test data and other submittals required by other Sections of the Specifications may be included in the Operating and Maintenance Manuals provided that they are approved and are formatted in a manner consistent with the requirements of this Section.
- D. Deliver Operation and Maintenance Manuals directly to the County.
- E. Operating and Maintenance Manual documents must include, but are not limited to, table of contents, approved submittals, manufacturer's operating and maintenance instructions, brochures, Shop Drawings, performance curves and data sheets annotated to indicate equipment actually furnished (e.g. identifying impeller size, model, horsepower, etc), procedures, wiring and control diagrams, records of factory and field tests and device/controller settings and calibration, program lists or data compact discs, maintenance and warranty terms and contact information, spare parts listings, inspection procedures, emergency instructions, and other Operating and Maintenance documentation that may be useful to the County. The material and equipment data required by this Section must include all data necessary for the proper installation, removal, normal operation, emergency operation, startup, shutdown, maintenance, cleaning, adjustment, calibration, lubrication, assembly, disassembly, repair, inspection, trouble-shooting, and warranty service of the equipment or materials.

- F. The Contractor must bind the Operating and Maintenance Manual documents in heavy-duty, 3-ring vinyl-covered binders including pocket folders for folded sheet information. Mark binder identification on both the front and spine of each binder. Binder information must list the project title, identify separate structures or locations as applicable, identify the general subject matter covered in the manual and must include the words "OPERATING AND MAINTENANCE INSTRUCTIONS".
 - 1. The Contractor must submit the Operating and Maintenance documents on three-hole punched, 8-1/2-inch x 11-inch sheets or on three-hole punched sheets that are foldable in multiples of 8-1/2-inch x 11-inch. The three-hole punched edge will be the left 11-inch edge.
 - 2. The Contractor may request waivers to the size requirement for specific instances. The Contractor's waiver request must be in writing to the County. The Contractor's waiver request must include a justification for seeking the waiver.

- G. The Contractor must provide an electronic version of the complete and final Operating and Maintenance Manuals in original electronic file format on compact disc or DVD. The Contractor must also provide one (1) electronic pdf file of each bound Operating and Maintenance Manual that represents each Manual's content. The electronic pdf file must match the Operating and Maintenance Manual content and organizational structure.

1.07 SUBSTANTIAL COMPLETION INSPECTION PROCEDURES

- A. Upon receipt of the Contractor's request for inspection, the County will either proceed with inspection or advise the Contractor of incomplete prerequisites.

- B. Following the initial inspection, the County will either prepare the certificate of Substantial Completion, or advise the Contractor of Work which must be performed before the certificate will be issued. The County will repeat the inspection when requested in writing and when assured that the Work has been substantially completed.

- C. Results of the completed inspection will form the initial "punch list" for final acceptance.

1.08 PREREQUISITES FOR FINAL ACCEPTANCE.

Complete the following before requesting the County's final inspection for certification of final acceptance, and final payment. List known exceptions, if any, in the request.

- A. Submit the final payment request with final releases and supporting documentation not previously submitted and accepted. Include certificates for insurance for products and completed operations where required.

- B. Submit written certification that:
 - 1. The County's final punch list of itemized Work to be completed or corrected, stating that each item has been completed or otherwise resolved for acceptance.
 - 2. The Contract Documents have been reviewed and Work has been completed in accordance with Contract Documents.

3. Equipment and systems have been tested in the presence of the County and are operational.
4. Work is completed and ready for final inspection.

C. Submit consent of surety.

D. Submit evidence of final, continuing insurance coverage complying with insurance requirements.

1.09 FINAL ACCEPTANCE INSPECTION PROCEDURES

A. The County will re-inspect the Work upon receipt of the Contractor's written notice that the Work, including punch list items resulting from earlier inspections, has been completed, except for those items for which completion has been delayed because of circumstances that are acceptable to the County.

B. Upon completion of re-inspection, the County will either prepare a certificate of final acceptance or advise the Contractor of Work that is incomplete or of obligations that have not been fulfilled, which are required for final acceptance.

C. If necessary, the re-inspection procedure will be repeated.

PART 2 - PRODUCTS (NOT USED)

PART 3 - EXECUTION (NOT USED)

END OF SECTION

1

THIS PAGE LEFT BLANK INTENTIONALLY

SECTION 01720
PROJECT RECORD DOCUMENTS

PART 1 - GENERAL

1.01 DESCRIPTION

- A. The purpose of the Project Record Documents is to provide the County with factual information regarding all aspects of the Work, both concealed and visible, to enable future location, identification and modification of the Work without lengthy and expensive site measurement, investigation or examination.
- B. These standards and procedures are for integration of digital engineering CAD drawings and attribute data into the database environments, while maintaining the integrity and positional accuracy of the data. The requirement for digital submittal of approved construction plans is to provide the County GIS with a parcel and utility base for field maintenance and operations.
- C. The location of the constructed improvements as depicted in the Contract Drawings is required. To insure the Work was constructed in conformance with the Contract Drawings, the following survey documents are required to be prepared and certified by the Surveyor:
 - 1. As-Built Asset Attribute Data Table (see Table 01050-2)
 - 2. Pipe Deflection Table (see Table 01050-3)
 - 3. Gravity Main Table (see Table 01050-4)
 - 4. Boundary Survey and Survey Map Report for pump stations and easements with constructed improvements.

1.02 DEFINITIONS

Except where specific definitions are used within a specific section, the following terms, phrases, words and their derivation shall have the meaning given herein when consistent with the context in which they are used. Words used in the present tense include the future tense, words in the plural number include the singular number and words in the singular number include the plural number.

- A. As-Built Drawings: Drawings prepared by the Contractor's Surveyor shall depict the actual location of installed utilities for the completed Work in a full size hard copy and an electronic AutoCAD file (dwg) format.
- B. Record Documents: All documents as required in subsections 1.04 and 2.02 in this specification section.
- C. Boundary Survey: Boundary survey, map and report certified by a Surveyor shall be provided that meets the requirements of Chapter 5J-17 'Minimum Technical Standards', FAC.

- D. Surveyor: Contractor's Surveyor that is licensed by the State of Florida as a Professional Surveyor and Mapper pursuant to Chapter 472, F.S.
- E. Survey Map Report: As a minimum the Survey Map Report shall identify any corners that had to be reset, measurements and computations made, pump station and easement boundary issues, locations of constructed improvements outside boundaries, and accuracies obtained.

1.03 QUALITY ASSURANCE

- A. Delegate the responsibility for maintenance of the Record Documents to one person on the Contractor's staff as approved by the County.
- B. Thoroughly coordinate changes within the Record Documents, making adequate and proper entries on each page of specifications and each sheet of Drawings and other documents where such entry is required to show progress and changes properly.
- C. Make entries within 24-hours after receipt of information has occurred.

1.04 RECORD DOCUMENTS AT SITE

- A. Maintain at the site and always available for County's use one (1) record copy of:
 - 1. Construction Contract, Drawings, Specifications, General Conditions, Supplemental Conditions, Bid Proposal, Instruction to Bidders, Addenda, and all other Contract Documents
 - 2. Change Orders, Verbal Orders, and other modifications to Contract
 - 3. Written instructions by the County as well as correspondence related to Requests for Information (RFIs)
 - 4. Accepted Shop Drawings, Samples, product data, substitution and "or-equal" requests
 - 5. Field test records, inspection certificates, manufacturer certificates and construction photographs
 - 6. Progressive As-Built Drawings
 - 7. Current Surveyor's tables for the As-Built Assets Attribute Data, Pipe Deflection Data, and Gravity Main Data
- B. Maintain the documents in an organized, clean, dry, legible condition and completely protected from deterioration and from loss and damage until completion of the Work, transfer of all record data to the final As-built Drawings for submittal to the County.
- C. Store As-Built Documents and samples in Contractor's office apart from documents used for construction. Do not use As-Built document for construction purposes. Label each document "AS-BUILT" in neat large printed letters. File documents and samples in accordance with CSI/CSC format.
- D. Record information concurrently with construction progress. Do not conceal any Work until required information is recorded.

PART 2 - PRODUCTS

2.01 AS-BUILT DRAWINGS

- A. Maintain the electronic As-Built Drawings to accurately record progress of Work and change orders throughout the duration of the Contract.
- B. Date all entries. Enter RFI No., Change Order No., etc. when applicable.
- C. Call attention to the entry by highlighting with a "cloud" drawn around the area affected.
- D. In the event of overlapping changes, use different colors for entries of the overlapping changes.
- E. Design call-outs shall have a thin strike line through the design call-out and all As-Built information must be labeled (or abbreviated "AB") and be shown in a bolder text that is completely legible.
- F. Make entries in the pertinent other documents while coordinating with the County for validity.
- G. Entries shall consist of graphical representations, plan view and profiles, written comments, dimensions, State Plane Coordinates, details and any other information as required to document field and other changes of the actual Work completed. As a minimum, make entries to also record:
 - 1. Depths of various elements of foundation in relation to finish floor datum and State Plane Coordinates and elevations.
 - 2. As-Built Asset Attribute Data Table shall be completed in the Drawings.
 - 3. When electrical boxes, or underground conduits and plumbing are involved as part of the Work, record true elevations and locations, dimensions between boxes.
 - 4. Actually installed pipe or other work materials, class, pressure-rating, diameter, size, specifications, etc. Similar information for other encountered underground utilities, not installed by Contractor, their owner and actual location if different than shown in the Contract Documents.
 - 5. Details, not on original Contract Drawings, as needed to show the actual location of the Work completed in a manner that allows the County to find it in the future.
 - 6. The Contractor shall mark all arrangements of conduits, circuits, piping, ducts and similar items shown schematically on the construction documents and show on the As-Built Drawings the actual horizontal and vertical alignments and locations.
 - 7. Major architectural and structural changes including relocation of doors, windows, etc. Architectural schedule changes according to Contractor's records and Shop Drawings.

2.02 RECORD DOCUMENTS

- A. Three (3) hard copy sets and three (3) digital media sets of the final Record Documents and shall include all of the documents described below under this subsection 2.02.

- B. The following documents shall be signed and sealed by the Surveyor:
1. As-Built Asset Attribute Data Table (see Specification Section 01050 "Surveying and Field Engineering," Table 01050-2 for an example)
 2. Boundary Survey of pump station and Survey Map Report
 3. Boundary Survey and Survey Map Report for the location of constructed pipes within any easements and right-of-way. As a minimum the Survey Map Report shall identify or describe the locations where the pipe centerline was constructed within 3-feet of the easement or right-of-way boundary, where the pipe was constructed outside the easement or right-of-way boundary, any corners that had to be reset, measurements and computations made, pump station boundary issues, and accuracies obtained. Survey map report shall be dated after the Work within the right-of-ways or easements have been completed.
 4. Gravity Main Table (see Specification Section 01050 "Surveying and Field Engineering", Table 01050-4 for an example)
 5. Pipe Deflection Table (see Specification Section 01050 "Surveying and Field Engineering" Table 01050-3 for an example). An electronic blank table will be supplied by the County.
- C. Digital sets of the final Record Documents including but not limited to:
1. Scanned digital copies of the final As-Built Drawings
 2. Electronic Survey documents electronically sealed by the Surveyor
 3. Final Record Documents information
 4. Digital As-Built Drawing in the Engineer's current version of AutoCAD file (dwg) format for the Contract Drawings, updated to match the final Record Drawing information
- D. Pump station site Boundary Survey and Map Report.
- E. New Boundary Survey to re-establish easement corners, right-of-way monuments, or pump station site corners with monuments if destroyed by the Work.
- F. Scanned Documents: Scan the Survey Documents and other Record Documents reflecting changes from the Bid Documents.
- G. The scanned "As-Built" Drawing sets shall be complete and include the title sheet, plan/profile sheets, cross-sections, and details. Each individual sheet contained in the printed set of the As-Built Drawings shall be included in the electronic drawings, with each sheet being converted into an individual tif (tagged image file). The plan sheets shall be scanned in tif format Group 4 at minimum of 400 dpi resolution to maintain legibility of each drawing. Then, the tif images shall be embedded into a single pdf (Adobe Acrobat) file representing the complete plan set. Review all Record Documents to ensure a complete record of the Project.

- H. Provide an encompassing digital AutoCAD file that includes all the information of the As-Built Drawings and any other graphical information in the As-Built Drawings. It shall include the overall Work, utility system layout and associated parcel boundaries and easements. Feature point, line and polygon information for new or altered Work and all accompanying geodetic control and survey data shall be included. The surveyor's certified As-Built Asset Attribute Data shall be added to the As-Built Drawings and Surveyor shall electronically seal the data in a comma-delineated ASCII format (txt).

PART 3 - EXECUTION

3.01 PRE-CONSTRUCTION MEETING

- A. Pre-construction Meeting: It is recommended that the Surveyor attend the Pre-construction meeting. At the pre-construction meeting the Contractor shall be provided with a blank electronic version of the spreadsheet for the tables: Asset Attribute Data and Pipe Deflection. The Contractor's surveyor shall use these tables to input the data and shall not alter the table format or formulas.

3.02 CONSTRUCTION PROGRESS MEETINGS

- A. Contractor shall provide progressive Record Documents described below:
1. Construction Contract, As-Built Drawings, Specifications, General Conditions, Supplemental Conditions, Bid Proposal, Instruction to Bidders, Addenda, and all other Contract Documents.
 2. Specifications and Addenda: Record manufacturer, trade name, catalog number and supplier of each product and item of equipment actually installed as well as any changes made by Field Order, Change Order or other.
 3. Change orders, verbal orders, and other modifications to Contract.
 4. Written instructions by the County as well as correspondence related to Requests for Information (RFIs).
 5. Accepted Shop Drawings, samples, product data, substitution and "or-equal" requests.
 6. Field test records, inspection certificates, manufacturer certificates and construction photographs.
 7. As-Built Asset Attribute Data Table: Surveyor shall obtain field measurements of vertical and horizontal dimensions of constructed improvements. The monthly submittal shall include the Surveyor's certified statement regarding the constructed improvements being within the specified accuracies as described in Specification Section 01050 "Surveying and Field Engineering", Table 01050-1 Minimum Survey Accuracies or if not, indicating the variances.
 8. Gravity Main Table: Surveyor shall prepare and update a Gravity Main Table to include as a minimum the pipe segment identification, pipe lengths, manhole inverts and tops, and slopes for gravity mains. Surveyor shall certify the data entered are correct and indicate if the minimum slopes have not been met.

9. Pipe Deflection Table: Surveyor shall input the type of pipe, pipe manufacturer, PVC manufacturer deflection allowance, allowable angle of offset and radius of curvature, laying length of pipe, and coordinates. Surveyor shall certify the data entered are correct and indicate if the deflection allowance, offset or radius of curvature exceeds the manufacturer's recommendations.

3.03 FINAL RECORD DOCUMENTS SUBMITTAL

- A. Submit the Final Record Documents within 20-days after Substantial Completion.
 1. Participate in review meetings as required and make required changes and promptly deliver the Final Record Documents to the County.

3.04 STORAGE AND PRESERVATION

- A. Store Record Documents and samples at a protected location in the project field office apart from documents used for construction.
 1. Provide files and racks for storage of documents
 2. Provide locked cabinet or secure space for storage of samples
- B. File documents and samples in accordance with CSI format with section numbers matching those in the Contract Documents.
- C. In the event of loss of recorded data, use means necessary to again secure the data to the County's approval.
 1. Such means shall include, if necessary in the opinion of the County, removal and replacement of concealing materials.
 2. In such cases, provide replacements of the concealing materials to the standards originally required by the Contract Documents.

END OF SECTION

SECTION 01730
PUMP STATION OPERATION AND MAINTENANCE MANUAL

PART 1 - GENERAL

1.01 REQUIREMENTS INCLUDED

- A. Section includes the submittal process for the operation and maintenance manual and the manual shall contain the technical information required for proper installation, operation and maintenance of process, electrical and mechanical equipment and systems.

1.02 SUBMITTAL SCHEDULE

- A. Operation and Maintenance Manual Schedule
 - 1. Initial submittal within 60-days after date Shop Drawings are approved.

1.03 PREPARATION OF SUBMITTALS

- A. General
 - 1. Materials are provided for County's use, reproduction and distribution as training and reference materials within County's organization.
 - 2. Applicable to hard copy or electronic media.
 - 3. Applicable to materials containing copyright notice as well as those with no copyright notice.
 - 4. Notify manufacturer of this intended use of materials provided under the Contract.
 - 5. Number each Operation and Maintenance Manual transmittal with the original root number of the associated Shop Drawing.
 - 6. Identify resubmittals with the original number plus a suffix letter starting with "A."
 - 7. Submittal format:
 - a. Interim submittals: Submit two (2) paper copies until manual is approved.
 - b. Final submittals:
 - (1) Within 30-days of receipt of approval, submit one (1) additional paper copy and two (2) electronic copies on Compact Disc (CD-ROM) in Portable Document Format (PDF).
 - 8. Compact discs to be secured in jewel cases.
 - 9. Electronic copies will be reviewed for conformance with the approved paper copy and the electronic copy (PDF) requirements of this Specification.
 - 10. Non-conforming CDs will be returned with comments.
 - 11. Provide final CDs within 30-days of receipt of comments.
 - 12. Paper copy submittals:
 - a. Submit Operation and Maintenance Manuals printed on 8-1/2 inch x 11 inch size heavy first quality paper with standard three-hole punching and bound in appropriately sized three-ring (or post) vinyl view binders with clear overlays front, spine and back.

- b. Provide binders with titles inserted under clear overlay on front and on spine of each binder.
 - c. As space allows, binder titles shall include, but not necessarily be limited to:
 - (1) Project Name
 - (2) Related Specification Number
 - (3) Equipment Name(s) and
 - (4) Project Equipment Tag Numbers
 - d. Provide a Cover Page for each manual with the following information:
 - (1) Manufacturer(s)
 - (2) Date
 - (3) Project Owner and Project Name
 - (4) Specification Section
 - (5) Project Equipment Tag Numbers
 - (6) Model Numbers
 - (7) Engineer
 - (8) Contractor
 - e. Provide a Table of Contents or Index for each manual.
 - f. Use plastic-coated dividers to tab each section of each manual per the manual's Table of Contents/Index for easy reference.
 - g. Provide plastic sheet lifters prior to first page and following last page.
 - h. Reduce Drawings or diagrams bound in manuals to an 8-1/2 inch x 11 inch or 11 inch x 17 inch size.
 - i. Where reduction is not practical to ensure readability, fold larger Drawings separately and place in vinyl envelopes which are bound into the binder.
 - j. Identify vinyl envelopes with Drawing numbers.
 - k. Mark each sheet to clearly identify specific products and component parts and data applicable to the installation for the Project.
 - l. Delete or cross out information that does not specifically apply to the Project.
- B. Electronic copy submittals:
- 1. Electronic copies of the approved paper copy Operation and Maintenance Manuals are to be produced in Adobe Acrobat's Portable Document Format (PDF) Version {5.0} or higher.
 - 2. Do *not* password protect and/or lock the PDF document.
 - 3. Drawings or other graphics must be converted to PDF format and made part of the PDF document.
 - 4. Scanning to be used only where actual file conversion is not possible.
 - 5. Rotate pages that must be viewed in landscape to the appropriate position for easy reading.
 - 6. Images only shall be scanned at a resolution of 300 dpi or greater.
 - 7. Perform Optical Character Recognition (OCR) capture on all images.
 - 8. Achieve OCR with the "original image with hidden text" option.
 - 9. Word searches of the PDF document must operate successfully to demonstrate OCR compliance.
 - 10. Create bookmarks in the navigation frame, for each entry in the Table of Contents/Index.

11. Normally three levels deep (i.e., "Chapter," "Section," "Sub-section").
12. Thumbnails must be generated for each PDF file.
13. Set the opening view for PDF files as follows:
 - a. Initial view: Bookmarks and Page.
 - b. Magnification: Fit in Window.
 - c. Page layout: Single page.
 - d. Set the file to open to the cover page of the manual with bookmarks to the left, and the first bookmark linked to the cover page.
 - e. All PDF documents shall be set with the option "Fast Web View" to open the first pages of the document for the viewer while the rest of the document continues to load.
14. File naming conventions
 - a. File names shall use a "ten dot three" convention (XXXXXX-YY-Z.PDF) where XXXXX is the Specification Section number, YY is the Shop Drawing Root number and Z is an ID number used to designate the associated volume.

Example 1:

Two (2) pumps submitted as separate Shop Drawings under the same Specification Section:

Pump 1 = 11061-01-1.pdf.

Pump 2 = 11061-02-1.pdf.

Example 2:

Control system submitted as one (1) Shop Drawing but separated into two (2) O&M volumes:

Volume 1 = 13440-01-1.pdf.

Volume 2 = 13440-01-2.pdf.

15. As a minimum, include the following labeling on all CD-ROM discs and jewel cases:
 - a. Project Name
 - b. Equipment Name and Project Tag Number
 - c. Project Specification Section
 - d. Manufacturer Name
 - e. Vendor Name
 - f. Binding
 - (1) Include labeled CD(s) in labeled jewel case(s).
 - (2) Bind jewel cases in standard three-ring binder Jewel Case Page(s), inserted at the front of the Final paper copy submittal.
 - (3) Jewel Case Page(s) to have means for securing Jewel Case(s) to prevent loss (e.g., flap and strap).

1.04 EQUIPMENT AND SYSTEMS

- A. Submission of Operation and Maintenance Manuals for equipment and systems is applicable but not necessarily limited to:
 1. Major equipment

2. Equipment powered by electrical, pneumatic or hydraulic systems
3. Specialized equipment and systems including instrumentation and control systems and system components for HVAC process system control
4. Valves and water control gates
5. Equipment function, normal operating characteristics, limiting operations
6. Assembly, disassembly, installation, alignment, adjustment, and checking instructions
7. Operating instructions for start-up, normal operation, control, shutdown, and emergency conditions
8. Lubrication and maintenance instructions
9. Troubleshooting guide
10. Parts lists
 - a. Comprehensive parts and parts price lists.
 - b. List of spare parts provided as specified in the associated Specification Section.
11. Outline, cross-section, and assembly Drawings; engineering data; and electrical diagrams, including elementary diagrams, wiring diagrams, connection diagrams, word description of wiring diagrams and interconnection diagrams.
12. Test data and performance curves.
13. As-constructed fabrication or layout Drawings and wiring diagrams.
14. Instrumentation or tag numbers assigned to the equipment by the Contract Documents are to be used to identify equipment and system components.
15. Additional information as specified in the associated equipment or system Specification Section.

1.05 COUNTY/PROFESSIONAL'S REVIEW ACTION

- A. County/Professional will review and indicate one of the following review actions:
 1. ACCEPTABLE
 2. REVISE AND RESUBMIT
- B. Acceptable paper copy submittals will be retained with the transmittal form returned with a request for one (1) additional paper copy and two (2) electronic copies on CD-ROM.
- C. Deficient submittals (paper copy and/or electronic copy) will be returned along with the transmittal form which will be marked to indicate deficient areas.

END OF SECTION

SECTION 01740
WARRANTIES AND BONDS

PART 1 - GENERAL

1.01 SCOPE OF WORK

- A. This Section specifies general administrative and procedural requirements for warranties and bonds required by the Contract Documents, including manufacturer's standard warranties on products and special warranties.

1.02 RELATED WORK

- A. Refer to Conditions of Contract for the general requirements relating to warranties and bonds.
- B. General closeout requirements are included in Section 01700 "Project Closeout."
- C. Specific requirements for warranties for the Work and products and installations that are specified to be warranted are included in the individual Sections of Division 2 through 16.

1.03 DEFINITIONS

- A. Standard Product Warranties are preprinted written warranties published by individual manufacturers for particular products and are specifically endorsed by the manufacturer to the County.
- B. Special Warranties are written warranties required by or incorporated in the Contract Documents, either to extend time limits provided by standard warranties or to provide greater rights for the County.

1.04 SUBMITTALS

- A. Submit written warranties to the County prior to requesting a Substantial Completion Inspection as outlined in Section 01700 "Project Closeout." If the Certificate of Substantial Completion designates a commencement date for warranties other than the date of Substantial Completion for the Work, or a designated portion of the Work, submit written warranties upon request of the County.
- B. When a designated portion of the Work is completed and occupied or used by the County, by separate agreement with the Contractor during the construction period, submit properly executed warranties to the County within 15-days of completion of that designated portion of the Work.

- C. When a special warranty is required to be executed by the Contractor, or the Contractor and a Subcontractor, supplier or manufacturer, prepare a written document that contains appropriate terms and identification, ready for execution by the required parties. Submit a draft to the County for approval prior to final execution.
- D. Refer to individual Sections of Divisions 2 through 16 for specific content requirements, and particular requirements for submittal of special warranties.
- E. Prior to Substantial Completion Inspection, submit to the County two (2) copies of each required warranty and bond properly executed by the Contractor, or by the Contractor, Subcontractor, supplier, or manufacturer. Organize the warranty documents into an orderly sequence based on the table of contents of the Project Manual.
 - 1. Bind warranties and bonds in heavy-duty, commercial quality, durable 3-ring vinyl covered loose-leaf binders, thickness as necessary to accommodate contents and sized to receive 8-1/2-inch by 11-inch three-hole punched paper.
 - 2. Table of Contents will be neatly typed, in the sequence of the Table of Contents of the Project Manual, with each item identified with the number and title of the specification Section in which specified and the name of the product or work item.
 - 3. Provide heavy paper dividers with celluloid covered tabs for each separate warranty. Mark the tab to identify the product or installation. Provide a typed description of the product or installation, including the name of the product and the name, address and telephone number of the installer, supplier and manufacturer.
 - 4. Identify each binder on the front and the spine with the typed or printed title "WARRANTIES AND BONDS", the project title or name and the name, address and telephone number of the Contractor.
 - 5. When operating and maintenance manuals are required for warranted construction, provide additional copies of each required warranty, as necessary, for inclusion in each required manual.

1.05 WARRANTY REQUIREMENT

- A. The Contractor will warrant all equipment in the Contractor's one-year warranty period even though certificates of warranty may not be required. For all major pieces of equipment, the Contractor shall submit a warranty from the equipment manufacturer. "Major" equipment is defined as a device having a 5 HP or larger motor or which lists for more than \$1,000.00.
- B. In the event that an equipment manufacturer or supplier is unwilling to provide a one-year warranty commencing at Substantial Completion, the Contractor will obtain from the manufacturer a warranty of sufficient length commencing at the time of equipment delivery to the job site, such that the warranty will extend to at least 1-year past substantial completion.
- C. If an individual specification section requires a particular warranty more stringent than that required by this Section or the General Conditions, the more stringent requirements will govern for the applicable portion of the Work.

- D. Related Damages and Losses: When correcting warranted Work that has failed, remove and replace other Work that has been damaged as a result of such failure or that must be removed and replaced to provide access for correction of warranted Work.
- E. Reinstatement of Warranty: When Work covered by a warranty has failed and been corrected by replacement or rebuilding, reinstate the warranty by written endorsement. The reinstated warranty will be equal to the original warranty with an equitable adjustment for depreciation.
- F. Replacement Cost: Upon determination that Work covered by a warranty has failed, replace or rebuild the Work to an acceptable condition complying with requirements of Contract Documents. The Contractor is responsible for the cost of replacing or rebuilding defective Work regardless of whether the County has benefited from use of the Work through a portion of its anticipated useful service life.
- G. County's Recourse: Written warranties made to the County are in addition to implied warranties, and will not limit the duties, obligations, rights and remedies otherwise available under the law, nor will warranty periods be interpreted as limitations on time in which the County can enforce such other duties, obligations, rights, or remedies.
- H. Rejection of Warranties: The County reserves the right to reject warranties and to limit selections to products with warranties not in conflict with requirements of the Contract Documents.
- I. The County reserves the right to refuse to accept Work for the project where a special warranty, certification, or similar commitment is required on such work or part of the Work, until evidence is presented that entities required to counter-sign such commitments are willing to do so.
- J. Disclaimers and Limitations: Manufacturer's disclaimers and limitations on product warranties do not relieve the Contractor of the warranty on the Work that incorporates the products, nor does it relieve suppliers, manufacturers, and Subcontractors required to countersign special warranties with the Contractor.

PART 2 - PRODUCTS (NOT USED)

PART 3 - EXECUTION

3.01 DELIVERABLES

- A. Assemble warranties, bonds and service and maintenance contracts, executed by each of the respective manufacturers, suppliers, and Subcontractors, and bind into a commercial quality standard 3-ring binder; submit 5 copies of the warranties and bonds to the County for review.
 - 1. The warranties and bonds shall include:
 - a. Equipment or product description
 - b. Manufacturer's name, principal, address and telephone number

- c. Contractor, name of responsible principal, address and telephone number
- d. Local supplier's or representatives name and address
- e. Scope of warranty or bond
- f. Proper procedure in case of failure
- g. Instances which might affect the validity of warranty or bond
- h. Date of beginning of warranty, bond or service and maintenance contract
- i. Duration of warranty, bond or service maintenance contract

B. Warranties

1. Furnish an extended warranty for sanitary sewer main liner certified by the manufacturer for specified material properties for a particular job. The manufacturer warrants the liner to be free from defects in raw materials for 1-year from the date of acceptance. During the warranty period, any defects which affect the integrity or strength of the pipe shall be repaired at the Contractor's expense in a manner acceptable to the County.
2. Furnish an extended warranty for sanitary lateral liner certified by the manufacturer for specified material properties for a particular job. The manufacturer warrants the liner to be free from defects in raw materials for 1-year from the date of acceptance. During the warranty period, any defects which affect the integrity or strength of the pipe shall be repaired at the Contractor's expense in a manner acceptable to the County.

END OF SECTION

SECTION 02050
DEMOLITION OF EXISTING STRUCTURES

PART 1 - GENERAL

1.01 DESCRIPTION

A. Scope of Work

1. This Section specifies the labor, materials, equipment, and incidentals required for the demolition, relocation, and/or disposal of all structures, building materials, equipment, and accessories to be removed as shown on the Drawings and as specified herein.
2. There may be existing and active stormwater, wastewater, water, and other facilities on site as indicated on the Drawings. It is essential that these facilities, when encountered, remain intact and in service during the proposed demolition. Consequently, the Contractor shall be responsible for the protection of these facilities and shall diligently direct all his activities toward maintaining continuous operation of the existing facilities and minimizing operational inconvenience.
3. Demolition generally includes:
 - a. Complete demolition and removal of manholes, valve vaults, wetwells, piping, and mechanical and electrical equipment related to the Work as shown on the Drawings and specified herein.
 - b. Complete demolition and removal of all above and below ground structures, concrete slabs and foundations, vaults, and underground utilities (water, wastewater, electrical, etc.) as shown on the Drawings and specified herein.
 - c. All material, equipment, rubble, debris, and other products of the demolition shall become the property of the Contractor for his disposal off-site in accordance with all applicable laws and ordinances at the Contractor's expense. The sale of salvageable materials by the Contractor shall only be conducted off-site. The sale of removed items on the site is prohibited by the County.
4. The Contractor shall examine the various Drawings, visit the site, determine the extent of the Work, the extent of work affected therein, and all conditions under which he is required to perform the various operations.
5. The Contractor shall fill and compact all voids left by the removal of pipe, structures, etc. with materials described herein to a grade that will provide for positive drainage of the disturbed area to drain run-off in direction consistent with the surrounding area. The Contractor shall provide all fill materials to the site as needed. Compaction of fill shall match the compaction of adjacent undisturbed material.

1.02 QUALITY ASSURANCE

- A. Permits and Licenses: Contractor shall obtain all necessary permits and licenses for performing the Work and shall furnish a copy of same to the County prior to commencing the Work. The Contractor shall comply with the requirements of the permits.

- B. Notices: Contractor shall issue written notices of planned demolition to companies or local authorities owning utility conduit, wires, or pipes running to or through the project site. Copies of said notices shall be submitted to the County.
- C. Utility Services: Contractor shall notify utility companies or local authorities furnishing gas, water, electrical, telephone, or sewer service to remove any equipment in the structures to be demolished and to remove, disconnect, cap, or plug their services to facilitate demolition.
- D. Contractor shall notify the Orange County Risk Management Department in writing prior to beginning any demolition work.

1.03 SHOP DRAWINGS AND SUBMITTALS

- A. Submittals shall be submitted to the County for review and acceptance prior to construction in accordance with the General Conditions and specifications Section 01300 "Submittals."
- B. Submit to the County for their approval, 2 copies of proposed methods and operations of demolition or relocation of the structures specified below prior to the start of Work. Include in the schedule the coordination of shut-off, capping, and continuation of utility service as required.
- C. Provide a detailed sequence of demolition and removal work to ensure the uninterrupted progress of the County's operations.
- D. Before commencing demolition work, all structure relocation, bypassing, capping, or modifications necessary will be completed. Actual work will not begin until the County has inspected and approved the prerequisite work and authorized commencement of the demolition work.
- E. The above procedure must be followed for each individual demolition operation.

1.04 SITE CONDITIONS

- A. Prior to demolition, the Contractor shall obtain written verification from the utility owner(s) that the existing utilities, including stormwater, wastewater, and/or water facilities, are not operational and are ready for demolition.
- B. The County assumes no responsibility for the actual condition of the structures to be demolished or relocated.
- C. Conditions existing at the time of inspection for bidding purposes will be maintained by the County insofar as practicable. However, variations within each site may occur prior to the start of demolition work.
- D. No additional payment will be made for pumping or other difficulties encountered due to water.

- E. Certain information regarding the reputed presence, size, character and location of existing underground structures, pipes and conduit has been shown on the Drawings. There is no certainty of the accuracy of this information, and the location of underground structures shown may be inaccurate and other obstructions than those shown may be encountered. The Contractor hereby distinctly agrees that the County is not responsible for the correctness or sufficiency of the information given; that in no event is this information to be considered as a part of the Contract; that he shall have no claim for delay or extra compensation on account of incorrectness of information regarding obstructions either revealed or not revealed by the Drawings; and that he shall have no claim for relief from any obligation or responsibility under this Contract in case the location, size, or character of any pipe or other underground structure is not as indicated on the Drawings, or in case any pipe or other underground structure is encountered that is not shown on the Drawings.

1.05 RESTRICTIONS

- A. No building, tank or structure, or any part thereof, shall be demolished until an application has been filed by the Contractor with the Building Department Inspector and a permit issued if a permit is required. The fee for this permit shall be the Contractor's responsibility. Demolition shall be in accordance with applicable provisions of the Building Code of the State of Florida.
- B. No explosives shall be used at any time during the demolition. No burning of combustible material will be allowed.
- C. Contractor shall notify the Orange County Risk Management Department prior to beginning any demolition work.

1.06 DISPOSAL OF MATERIAL

- A. All salvageable or useable material or equipment to be retained by the County shall be shown on Drawings, and shall be moved to a designated area by Contractor for pick up by County. The Contractor shall promptly remove all other materials from the site as indicated or shown on the Drawings.
- B. All materials not retained by the County shall become the Contractor's property and shall be removed off-site.
- C. The on-site storage of removed items is prohibited by the County. Off-site sale of salvageable material by the Contractor is acceptable.

1.07 TRAFFIC AND ACCESS

- A. Conduct work to ensure minimum interference with on-site and off-site roads, streets, sidewalks, and occupied or used facilities.

- B. Special attention is directed towards maintaining safe and convenient access to the existing facilities remaining in operation by plant personnel and plant associated vehicles, including trucks and delivery vehicles.
- C. Do not close or obstruct streets, sidewalks, or other occupied or used facilities without permission from the County. Provide alternate routes around closed or obstructed traffic in access ways.

1.08 PROTECTION

- A. Conduct operations to minimize damage by falling debris or other causes to adjacent buildings, structures, roadways, other facilities, and persons. Provide interior and exterior shoring, bracing, or support to prevent movement or settlement or collapse of structures to be demolished and adjacent facilities to remain.

1.09 DAMAGE

- A. Promptly repair damage caused to adjacent facilities by demolition operations as directed by the County at no cost to the County.

1.10 UTILITIES

- A. Maintain existing utilities as directed by the County to remain in service and protect against damage during demolition operations.
- B. Do not interrupt existing utilities serving occupied or operational facilities, except when authorized by County. Provide temporary services during interruptions to existing utilities as acceptable to the County.
- C. The Contractor shall cooperate with the County to shut off utilities serving structures of the existing facilities as required by demolition operations.
- D. The Contractor shall be solely responsible for making all necessary arrangements and for performing any necessary work involved in connection with the interruption of all public and private utilities or services.
- E. All utilities being abandoned shall be terminated at the service mains in conformance with the requirement of the utility companies or the municipality owning or controlling them.

1.11 EXTERMINATION

- A. If required, before starting demolition, the Contractor shall employ a certified rodent and vermin exterminator and treat the facilities in accordance with governing health laws and regulations. Any rodents, insects, or other vermin appearing before or during the demolition shall be killed or otherwise prevented from leaving the immediate vicinity of the demolition work.

1.12 POLLUTION CONTROL

- A. For pollution control, use water sprinkling, temporary enclosures, and other suitable methods as necessary to limit the amount of dust rising and scattering in the air to the lowest level of air pollution practical for the conditions of work. The Contractor shall comply with the governing regulations.
- B. Clean adjacent structures and improvements of all dust and debris caused by demolition operations as directed by the County. Return areas to conditions existing prior to the start of Work.

PART 2 - PRODUCTS (NOT USED)

PART 3 - EXECUTION

3.01 SEQUENCE OF WORK

- A. The sequence of demolition and relocation of existing facilities shall be in accordance with the approved critical path schedule as specified in paragraph 1.03 above.

3.02 REMOVAL OF EXISTING PROCESS EQUIPMENT, PIPING, AND APPURTENANCES

- A. Equipment to be retained by the County will be designated for retention by the County prior to bidding as specified in Paragraph 1.06 above. Subject to the constraints of maintaining existing facilities in operation as shown on the Drawings, all other process equipment, non-buried valving and piping, and appurtenances shall be removed from the site.

3.03 DEMOLITION PROCEDURES

The Contractor shall adhere to the following demolition procedures as referenced on the Drawings:

- A. **TO BE DEMOLISHED:** Demolition shall be the breaking up, cutting, filling of any holes resulting, final grading of the area, performing any other operations required, and the removal from the site of all structures and equipment (structures, substructures, floor slabs, equipment, tanks, pipes, fittings, electrical systems, light poles, wiring, underground conduits and wiring, isolated slabs, and sidewalks) as indicated on the Drawings. All pieces of concrete, metal, and any other demolished material shall be removed to a depth of at least 5-feet below existing grade. Broken pieces of concrete may be size reduced by an on-site crusher, but in any event must be removed from the project site.

Before commencing structural demolition, remove all mechanical, electrical, piping, and miscellaneous appurtenances. Completely remove the structure by thoroughly breaking up concrete into pieces no more than 2-feet across the largest dimension.

- B. TO BE REMOVED: Where indicated on the Drawings, the structures and equipment shall be completely removed from the site with all associated connecting piping or electrical service. The item shall be taken whole or in parts to be salvaged or disposed of by the Contractor.
- C. TO BE ABANDONED: Where indicated on the Drawings, the structures and equipment shall be left in place, drained, and the contents properly disposed. The upper 4-feet of the structure shall be cut and removed, including the cover slab and access port, frame, and cover. All structures to be abandoned with bottom slabs shall be drilled (2 holes minimum, 2.0-inch diameter each) or hole punched to prevent flotation and filled with common fill.
- D. PIPING TO BE REMOVED: Where indicated on the Drawings, pipe (and conduit) shall be drained and the contents properly disposed. The pipe (or conduit) shall then be completely removed from the site, including fittings, valves, and other in-line devices. Connections to existing piping to remain shall be plugged by mechanical means (M.J. plugs, tie-rods, or thrust blocks). Piping shall be removed in accordance with Specification Section 02080 "Abandonment, Removal and Salvage or Disposal of Existing Pipe."
- E. PIPING TO BE ABANDONED: Where indicated on the Drawings, piping (or conduit) shall be left in place. All such piping shall be drained and the contents properly disposed. The pipe (or conduit) shall then be filled with grout (flowable fill) and each end of the pipe (or conduit) shall be plugged using a concrete plug in a manner acceptable to the County. Piping shall be abandoned in accordance with Specification Section 02080 "Abandonment, Removal and Salvage or Disposal of Existing Pipe."
- F. TO BE PROTECTED: Where indicated on the Drawings, the utility service, fence, structure, tree, or device so designated shall be temporarily protected during the prosecution of the demolition work as specified in Division 1.
- G. TO REMAIN: Where indicated on the Drawings, the designated facilities shall remain intact and in service during the prosecution of the demolition work.

3.04 DEWATERING OF EXISTING PROCESS UNITS AND DISPOSAL OF RESIDUE

The Contractor shall notify the County prior to beginning the dewatering work on any existing process units which contain wastewater, grit, or sludge. The Contractor, at his own expense, shall remove the entire contents of each structure and dispose off site. The proper transport and disposal of all residues shall remain the responsibility of the Contractor.

END OF SECTION

SECTION 02080

ABANDONMENT, REMOVAL, AND SALVAGE OR DISPOSAL OF EXISTING PIPE

PART 1 - GENERAL

1.01 DESCRIPTION

- A. Scope of Work: This section specifies the furnishing of all labor, materials, equipment, and incidentals required to abandon, remove, salvage, and/or dispose of existing pipelines and appurtenances as shown on the Drawings and as specified herein.

1.02 QUALITY ASSURANCE

- A. Permits and Licenses: Contractor shall obtain and pay respective fees for all necessary permits and licenses for performing the Work and shall furnish a copy of same to the County prior to commencing the Work. The Contractor shall comply with the requirements of the permits. All removal or abandonment of asbestos pipe material shall be performed by a licensed asbestos abatement Contractor or Subcontractor registered in the State of Florida.
- B. Notices: Contractor shall issue written notices of planned Work to companies or local authorities owning utility conduit, wires, or pipes running to or through the project site. Copies of said notices shall be submitted to the County.
- C. Standards:
 - 1. Florida Administrative Code, Chapter 62-204.800
 - 2. National Emission Standards Hazardous Air Pollution (NESHAP), 40 CFR Part 61, Subpart M, latest revision
 - 3. Occupational Safety and Health Act, 29 CFR
 - 4. The Environmental Protection Agency (EPA) Asbestos Abatement Worker Protection Rule
 - 5. Florida Statute 455.300
 - 6. Asbestos pipe handling best management practices provided at the end of this section
- D. Quality Control
 - 1. It shall be the responsibility of the Contractor to provide supervision and inspections to ensure that the existing piping is removed and disposed, salvaged, or abandoned as designated in the Drawings and as specified herein.
 - 2. Asbestos Pipe
 - a. All removal or abandonment of pipe material containing asbestos shall be performed by a licensed asbestos abatement Contractor or Subcontractor.

- b. The asbestos abatement Contractor or Subcontractor shall contact the Orange County Environmental Protection Division (407-836-1400) prior to removal or abandonment of any asbestos material and shall obtain all required permits and licenses and issue all required notices as required by the Orange County Environmental Protection Division. The Contractor shall be responsible for all fees associated with permits, licenses, and notices to the governing regulatory agencies.
- c. The asbestos abatement Contractor shall perform Work in accordance with all applicable standards referenced in paragraph 1.02.C of this section.
- d. The asbestos abatement Contractor shall have experience performing asbestos removal similar to this Project.

1.03 SHOP DRAWINGS AND SUBMITTALS

A. Shop Drawings

1. Submittals shall be submitted to the County for review and acceptance prior to construction in accordance with the General Conditions and specifications Section 01300 "Submittals."
2. Shop Drawings shall be submitted to the County for review and acceptance prior to construction in accordance with these specifications for the following:
 - a. Grout
 - b. Caps and plugs
 - c. Credentials of licensed asbestos abatement Contractor including current certification.

PART 2 - PRODUCTS (NOT USED)

PART 3 - EXECUTION

3.01 REMOVAL, ABANDONMENT, SALVAGE, AND DISPOSAL

- A. General: Existing piping designated on the Drawings to be removed shall be exposed and removed by the Contractor.
- B. Removal and Disposal
 1. Pipe designated to be removed shall be completely drained and the contents properly disposed. The piping system including fittings and valves shall then be completely removed from the site.
 2. Existing services and/or connections not shown on the Drawings shall be removed in accordance with this section at no additional cost. Existing live services encountered shall be maintained.
 3. Asbestos: Pipe material containing asbestos shall be removed and disposed by a licensed asbestos abatement Contractor or Subcontractor.

4. Structures shall be removed in accordance with Section 02050 "Demolition of Existing Structures."

C. Removal of material to be salvaged

1. Pipe designated on the Drawings to be removed and salvaged shall be completely drained and the contents properly disposed. The pipe shall then be thoroughly pressure washed, palletized on wooden skids to a dimension not exceeding the recommendation of the manufacturer, and conveyed to the County at the location designated by the County.
2. Items to be salvaged:
 - a. Air release valves
 - b. Sanitary manhole rings and covers
 - c. Isolation valves
 - d. Valve boxes
 - e. Fire hydrant and valve assemblies

D. Abandonment

1. Pipe designated on the Drawings to be abandoned (or retired in place) shall be left in place, drained, and its contents properly disposed. Pipe requires end caps or plugs. All air release valves and vaults, valve boxes, fire hydrants, manholes, and manhole rings and covers shall be removed and disposed of or salvaged as specified above.
2. All pipe 4-inches or larger to be abandoned in place shall be completely filled with grout and each end of the pipe shall be plugged in a manner acceptable to the County.
3. Grout: Where designated on the Drawings, pipe to be abandoned shall be filled with grout in accordance with Section 03600 "Grouting."
4. Plugs: Pipe to be abandoned shall be capped or plugged with a mechanical joint fitting that will prevent soil or other deposits from entering the pipe.

E. Asbestos Pipe Handling Best Management Practices

1. Projects will require worker documentation before entering the regulated Work area. A copy of: their current training certificate (workers and their supervisor); current medical condition showing the doctor approved their working with asbestos and wearing a respirator; signed acknowledgment forms; and current record (6-months) of each workers respirator fit test will be required from all workers.
2. Projects also require air monitoring. OSHA will accept historic data on air monitoring within 12-months of the Project, provided the data is from a project of like material and conditions with a crew of the same experience, supervision, and training. Otherwise, monitoring is required throughout the Project. OSHA requires two (2) types of personnel air monitoring, full shift and 30-minute excursion level (when highest levels are anticipated).
3. Some provisions should be made for worker showering or otherwise washing following work before removing respirators, etc. Even if direct exposure is not anticipated, and at a minimum, a source of water to rinse the respirators, wash workers faces and hands, and (in the event of unanticipated direct exposure) some place to shower is required. The workers will also need a change room and some place to keep their street clothes and personal possessions.

4. Proposals to remove asbestos pipe sections by cutting must address how the cutting debris will be captured and kept from becoming airborne. Soil that could be considered contaminated may also have to be removed.
5. Licensed asbestos abatement Contractors or Subcontractors should have a pollution endorsement in their liability insurance in case of asbestos fiber release. A contingency plan, in case the project does not run as smoothly as expected, should be developed and include emergency phone numbers kept on site during the Project.
6. Daily logs of the asbestos removal work should be kept, and should include sign in sheets for the workers and whatever air monitoring was done. Accident reports and other reports or correspondence if something unusual happened should also be included.
7. Waste receipts must be kept through all stages of transport from the site to, and including, the acceptance at the dumpsite where the material will be abandoned. Amount of material removed must be equal to the amount of material to be turned into to the dump.
8. The primary Contractor will give "approval for tear down" at project completion, indicating that all asbestos removal operations are complete and whether there is a need for any air monitoring. Air monitoring, if not required by any governing agency or approved permit as discussed previously, may also be required by the County if documentation to the general public pertaining to contamination is deemed necessary. This air monitoring is normally done by collecting area samples downwind of the project at the barrier tape or just inside it. It requires a source of electricity to run the pumps, which is often provided by a generator.

END OF SECTION

SECTION 02100
TEMPORARY EROSION AND SEDIMENTATION CONTROL

PART 1 - GENERAL

1.01 DESCRIPTION

A. Scope of Work

1. The Work specified in this Section consists of designing, providing, maintaining and removing temporary erosion, sedimentation and turbidity controls as necessary.
2. Temporary erosion controls include, but are not limited to, grassing, mulching, setting, watering and reseeding on-site surfaces and soil and borrow area surfaces and providing interceptor ditches at ends of berms and at those locations which will ensure that erosion during construction will be either eliminated or maintained within acceptable limits as established by federal, state and local requirements and by the County.
3. Temporary sedimentation controls include, but are not limited to; silt fence, silt dams, traps, barriers, and appurtenances at the foot of sloped surfaces which will ensure that sedimentation pollution will be either eliminated or maintained within acceptable limits as established by federal, state and local requirements and by the County.
4. Temporary turbidity controls include, but are not limited to, floating or staked turbidity barriers which will ensure that turbidity pollution will be either eliminated or maintained within acceptable limits as established by Federal, state, and local requirements and by the County.
5. Contractor is responsible for providing effective temporary erosion, sediment, and turbidity control measures during construction or until permanent controls become effective.

- B. Related Work Described Elsewhere: South Florida Building Code and Standard Building Code, FDOT Standard Specifications for road and bridge construction and FDOT Design Standards.

PART 2 - PRODUCTS

2.01 EROSION CONTROL

- A. Netting Fence: fabricated of material acceptable to the County.
- B. Sod is specified in Section 02578, "Solid Sodding."

2.02 SEDIMENTATION CONTROL

- A. Bales: clean, seed-free cereal hay type.
- B. Netting: fabricated of material acceptable to the County.
- C. Filter stone: crushed stone conforming to Florida Department of Transportation specifications.

- D. Concrete block: hollow, non-load bearing type.
- E. Concrete: exterior grade not less than 1-inch thick.
- F. Rock Bags: conforming to FDOT Specifications.

2.03 TURBIDITY CONTROL

- A. Conforming to FDOT Design Standards Index 103 - Turbidity Barriers.

PART 3 - EXECUTION

3.01 EROSION CONTROL

- A. Minimum Procedures for Grassing Are:
 1. Scarify slopes to a depth of not less than 6-inches and remove large clods, rock, stumps and roots larger than 1/2-inch in diameter and debris.
 2. Sow seed within 24-hours after the ground is scarified with either mechanical seed drills or rotary hand seeders.
 3. Apply mulch loosely and to a thickness of between 3/4-inch and 1-1/2-inches.
 4. Apply netting over mulched areas on sloped surfaces.
 5. Roll and water seeded areas in a manner which will encourage sprouting of seeds and growing of grass. Reseed areas which exhibit unsatisfactory growth. Backfill and seed eroded areas.

3.02 SEDIMENTATION CONTROL

- A. Install and maintain silt fence, silt dams, traps, barriers and appurtenances as shown on the approved descriptions and working Drawings. Hay bales which deteriorate and filter stone which is dislodged shall be replaced.

3.03 TURBIDITY CONTROL

- A. Install and maintain turbidity barriers daily and as described in FDOT Index #103.

3.04 PERFORMANCE

- A. Should any of the temporary erosion and sediment control measures employed by the Contractor fail to produce results which comply with the requirements of the State of Florida, the Contractor shall immediately take whatever steps are necessary to correct the deficiency at his own expense.

END OF SECTION

SECTION 02140

DEWATERING

PART 1 - GENERAL

1.01 DESCRIPTION

- A. **Scope of Work:** This Section specifies the furnishing of equipment; labor and materials necessary to remove storm or subsurface waters from excavation areas in accordance with the requirements set forth, as shown on the Drawings, and/or geotechnical report.

1.02 QUALITY ASSURANCE

- A. **Qualifications:** The Contractor shall engage a Geotechnical Engineer registered in the State of Florida, to design the temporary dewatering system. The Contractor shall submit conceptual plan for the dewatering system prior to commencing work. The dewatering system installed shall be in conformity with the overall construction plan and certification of this shall be provided by the Geotechnical Engineer. The dewatering system shall be designed by a firm who regularly engages in the design of dewatering systems and who is fully experienced, reputable and qualified in the design of such dewatering systems.
- B. The dewatering of any excavation areas and the disposal of the water shall be in strict accordance with the latest revision of all local and state government rules and regulations.
- C. **Permits:** The Contractor shall obtain and pay respective fees for all local, state, and federal permits (including the Orange County, St. Johns River Water Management District, and/or South Florida Management District discharge permits) required for the withdrawal, treatment and disposal/discharge of water from the dewatering operation, prior to start of work.
- D. Comply with Florida Administrative Code, Chapter 62-621.300 (2).

1.03 SHOP DRAWINGS AND SUBMITTALS

- A. Submittals shall be submitted to the County for review and acceptance prior to construction in accordance with the General Conditions and specifications Section 01300 "Submittals."
- B. In accordance with FAC 62-621.300(2), submit analytical test results from a certified laboratory for the parameters listed in the FDEP "Generic Permit for the Discharge of Produced Ground Water from Any Non-Contaminated Site Activity" to the FDEP and the County. The submitted information shall show the location of the work, where the water will be going to, as well as an estimate for the amount, rate and duration of discharge being proposed.

- C. Provide notification to all jurisdictional permitting agencies in accordance with the requirements of the respective agency.
- D. Provide a detailed plan and operation schedule for dewatering of excavations.
 - 1. Provide descriptive literature of the dewatering system.
 - 2. Provide a plan for erosion and sedimentation control during dewatering.
 - 3. Provide copies of all permits/approvals for disposal/discharge of water during dewatering.

PART 2 - PRODUCTS (NOT USED)

PART 3 - EXECUTION

3.01 GENERAL

- A. The Contractor shall have on-site and available the analytical test results performed in accordance with the FDEP "Generic Permit for the Discharge of Produced Ground Water from Any Non-Contaminated Site Activity" (FAC 62-621.300(2)).
- B. The Contractor shall provide adequate equipment for the removal of storm or subsurface waters which may accumulate within the excavation.
- C. The Contractor's attention is directed to the water surface elevations discussed in the report(s) on subsurface investigations. Water levels will normally vary from season to season.
- D. The Contractor shall be required to monitor the performance of the dewatering system during the progress of the Work and make such modifications as may be required to assure that the systems will perform satisfactorily. The dewatering system shall be designed in such a manner as to preserve the undisturbed bearing capacity of the sub-grade soils at the bottom of the trench or excavation.
- E. Prior to excavation, the Contractor shall submit his proposed method of dewatering and maintaining dry conditions to the County. Approval of the dewatering plan shall not relieve the Contractor of the responsibility for the satisfactory performance of the system. The Contractor shall be responsible for correcting any disturbance of natural bearing soils or damage to structures caused by an inadequate dewatering system or by interruption of the continuous operation of the system as specified.
- F. If subsurface water is encountered, the Contractor shall utilize suitable equipment to adequately dewater the excavation. A wellpoint system or other County acceptable dewatering method shall be utilized if necessary to maintain the excavation in a dry condition for preparation of the trench bottom and for pipe laying. Within and adjacent to residential areas and other areas as required by the County, engines driving dewatering pumps shall be equipped with residential type mufflers and the noise shall not exceed 55 decibels within 50-feet.

3.02 DEWATERING AND DISPOSAL

- A. The Contractor shall construct and place all pipelines, structures, concrete work, structural fill, backfill and bedding material in-the-dry. In addition, the Contractor shall make the final 24-inches of excavation in-the-dry and not until the water level is a minimum of 2-foot below proposed bottom of excavation. For purposes of this Contract, in-the-dry is defined as $\pm 2\%$ of the optimum moisture content of the soil.
- B. The Contractor shall, at all times during construction, provide and maintain proper equipment and facilities to remove promptly and dispose of all water entering excavations. Contractor shall keep excavations dry so as to obtain a satisfactory undisturbed subgrade foundation condition until the fill, structure, or pipes have been completed to such extent that they will not be floated or otherwise damaged by allowing water levels to return to natural elevations.
- C. Dewatering shall at all times be conducted in such a manner as to preserve the natural undisturbed bearing capacity of the subgrade soils at proposed bottom of excavation.
- D. It is expected that dewatering will be required for pre-drainage of the soils prior to final excavation for most of the in-ground structures or piping and for maintaining the lowered groundwater level until construction has been completed so that the structure, pipeline or fill will not be floated or otherwise damaged.
- E. If wellpoints are used, Contractor shall adequately space wellpoints to maintain the necessary dewatering. Provide suitable filter sand and/or other means to prevent pumping of fine sands and silts. A continual check shall be maintained by the Contractor to ensure that the subsurface soil is not being removed by the dewatering operations. Pumping from wellpoints shall be continuous and standby pumps shall be provided.
- F. The Contractor's proposed method of dewatering shall include groundwater observation wells to determine the water level during construction. Observation wells shall be installed along pipelines as required to verify depth to water level and at locations approved by the County.
- G. At all times, site grading shall promote drainage. Surface runoff shall be diverted from excavations. Water entering the excavation from the surface shall be collected in shallow ditches around the perimeter of the excavation, drained to sumps, and pumped or drained by gravity to maintain an excavation bottom free from standing water.
- H. Flotation shall be prevented by the Contractor by maintaining a positive and continuous removal of water. The Contractor shall be fully responsible for all damages which may result from failure to adequately keep excavations dewatered.
- I. The Contractor shall dispose of water from the Work in a suitable manner without damage to adjacent properties or facilities. No water shall be discharged without appropriate treatment for adverse contaminants. No water shall be drained in work built or under construction without prior consent from the County. Water shall be filtered to remove sand and fine soil particles before disposal into any drainage system.

- J. Dewatering of excavations shall be considered incidental to the construction of the Work and all costs shall be included in the various Contract prices in the Bid Form, unless a separate bid item has been established for dewatering.

3.03 GROUNDWATER TREATMENT (IF REQUIRED)

- A. If concentrations of tested groundwater quality parameters exceed those allowable in the FDEP Generic Permit for the Discharge of Produced Groundwater from any Non-Contaminated Site Activity (62-621.300(2), F.A.C.), the Contractor shall treat the effluent.
- B. The Contractor shall immediately notify the County and discuss the parameters that exceed allowable limits.
- C. The Contractor shall meet with the FDEP to determine alternatives that are acceptable to the FDEP.
- D. The Contractor shall apply for and obtain any and all permits and/or treatment approvals that FDEP requires including but not limited to:
 - 1. Generic Permit for Discharges from Petroleum Contaminated Sites (62-621.300(1)). Allows discharges from sites with automotive gasoline, aviation gasoline, jet fuel, or diesel fuel contamination; or
 - 2. Permit for all Other Contaminated Sites (62-04; 62-302; 62-620 & 62-660). The coverage is available only through the individual NPDES permit issued by FDEP, allows discharges from sites with general contaminant issues i.e. ground water and/or soil contamination other than petroleum fuel contamination; or
 - 3. Generic Permit for the Discharge of Produced Ground Water from Any Non-Contaminated Site Activity (62-621.300(2), F.A.C.); or
 - 4. Generic Permit for Stormwater Discharge from Large or Small Construction Activities (62-621.300(4)(a), F.A.C.); or
 - 5. An Individual Wastewater Permit (62-604.300(8) (a))
- E. The Contractor shall implement the appropriate treatment that is acceptable to FDEP and County to attain compliance for all excess limits encountered during dewatering activities. Treatment may include, but is not limited to: Chemical, Biological, Electrolysis or any combination of the three.
- F. The Contractor shall make every effort to minimize the spread of contamination into uncontaminated areas. Provide for the health and safety of all workers at the job site and make provisions necessary for the health and safety of the public that may be exposed to any potentially hazardous conditions. Ensure provision adhere to all applicable laws, rules or regulations covering hazardous conditions and will be in a manner commensurate with the level of severity of the conditions.
- G. If necessary, provide contamination assessment and remediation personnel to handle site assessment, determine the course of action necessary for site security and perform the necessary steps under applicable laws, rules and regulations for additional assessment and/or remediation work to resolve the contaminations issue.

- H. Delineate the contamination area(s) and any staging or holding area required and develop a work plan that will provide the schedule of projected completion dates for the final resolution of the contamination issue.
- I. Maintain jurisdiction over activities inside any delineated contamination areas and any associated staging or holding areas. Be responsible for the health and safety of workers within the delineated areas. Provide continuous access to representatives of regulatory or enforcement agencies having jurisdiction.

3.04 REMOVAL

Immediately upon completion of the dewatering system, the Contractor shall remove all of his equipment, materials, and supplies from the site of the Work, remove all surplus materials and debris, fill in all holes or excavations, and grade the site to elevations of the surface levels which existed before work started. The site shall be thoroughly cleaned and approved by the County.

END OF SECTION

1

THIS PAGE LEFT BLANK INTENTIONALLY

SECTION 02215
FINISH GRADING

PART 1 - GENERAL

1.01 DESCRIPTION

- A. Scope of Work: Provide finish grading to all areas within the limits of construction.
- B. Grade sub-soil. Cut out areas to receive stabilizing base course materials for paving and sidewalks. Place, finish grade, and compact topsoil.

1.02 PROTECTION

- A. Prevent damage to existing fencing, trees, landscaping, natural features, benchmarks, pavement, and utility lines. Correct damage at no cost to the County.

1.03 SHOP DRAWINGS AND SUBMITTALS

- A. Submittals shall be submitted to the County for review and acceptance prior to construction in accordance with the General Conditions and specifications Section 01300 "Submittals."

PART 2 - PRODUCTS

2.01 MATERIALS

- A. All material supplied shall be one of the products specified in Appendix D "List of Approved Products" appended to these technical specifications.
- B. Topsoil: Friable loam free from subsoil, roots, grass, excessive amount of weeds, stones, and foreign matter; acidity range (pH) of 5.5 to 7.5; containing a minimum of 4% and a maximum of 25% organic matter. The topsoil shall be suitable for the proposed plant growth shown on the Drawings and specified. Use topsoil stockpiles on site if conforming to these requirements. If there is not sufficient topsoil available at the project site, the Contractor shall furnish additional topsoil as required to complete the Work at no additional cost to the County.

PART 3 - EXECUTION

3.01 SUB SOIL PREPARATION

- A. Rough grade sub-soil systematically to allow for a maximum amount of natural settlement and compaction. Eliminate uneven areas and low spots. Remove debris, roots, branches, stones, etc. Remove sub-soil that has been contaminated with petroleum products.

- B. Cut out areas to subgrade elevation which are to receive stabilizing base for paving and sidewalks.
- C. Bring sub soil to required levels, profiles, and contours. Make changes in grade gradual. Blend slopes into level areas.
- D. Slope grade away from building a minimum of 2-inches in 10-feet unless indicated otherwise on the Drawings.
- E. Cultivate subgrade to a depth of 3-inches where topsoil is to be placed. Repeat cultivation in areas where equipment used for hauling and spreading topsoil has compacted sub-soil.

3.02 PLACING TOPSOIL

- A. Place topsoil in areas where seeding, sodding, and planting is to be performed. Place to the following minimum depths, up to finished grade elevations.
 - 1. 6-inches for seeded areas
 - 2. 4-1/2-inches for sodded areas
 - 3. 24-inches for shrub beds
 - 4. 18-inches for flower beds
- B. Use topsoil in relatively dry state. Place during dry weather.
- C. Fine grade topsoil eliminating rough and low areas to ensure positive drainage. Maintain levels, profiles, and contours of subgrades.
- D. Remove stones, roots, grass, weeds, debris, and other foreign material while spreading.
- E. Manually spread topsoil around trees, plants, and buildings to prevent damage which may be caused by grading equipment.
- F. Lightly compact placed topsoil.

3.03 SURPLUS MATERIAL

- A. Remove surplus sub soil and topsoil from site.
- B. Leave stockpile areas and entire job site clean and raked, ready to receive landscaping.

END OF SECTION

SECTION 02220
EXCAVATING, BACKFILLING, AND COMPACTING

PART 1 - GENERAL

1.01 DESCRIPTION

- A. Scope of Work: Excavate, backfill, and compact as required for the construction of the utility system consisting of piping and appurtenances, and structural construction as shown on the Drawings and specified herein. The Contractor shall furnish all labor, materials, equipment, and incidentals necessary to perform all excavation, backfill, compaction, grading, and slope protection to complete the Work. The Contractor shall be responsible for having determined to his satisfaction, prior to the submission of his bid, all under ground utilities locations and appurtenances shown on the construction Drawings.
- B. Definitions:
1. Maximum Density: Maximum weight in pounds per cubic foot of a specific material as determined by AASHTO T-180 (ASTM D155).
 2. Optimum Moisture: Percentage of water in a specific material at maximum density.
 3. Rock Excavation: Excavation of any hard natural substance which requires the use of explosives and/or special impact tools such as jack hammers, sledges, chisels, or similar devices specifically designed for use in cutting or breaking rock, but exclusive of trench excavating machinery.
 4. Suitable: Suitable materials for fills shall be non-cohesive, non-plastic granular local sand and shall be free from vegetation, organic material, marl, silt, or muck. The Contractor shall furnish all additional fill material required.
 5. Unsuitable: Unsuitable materials are highly organic soil (peat or muck) classified as A-8 in accordance with AASHTO Designation M 145.
- C. Plan For Earthwork: The Contractor shall be responsible for having determined to his satisfaction, prior to the submission of his bid, the conformation of the ground, the character and quality of the substrata, the types and quantities of materials to be encountered, the nature of the groundwater conditions, the prosecution of the Work, the general and local conditions, and all other matters which can in any way affect the Work under this Contract. Prior to commencing the excavation, the Contractor shall submit a plan of his proposed operations, including maintenance of traffic, to the County for review. The Contractor shall consider, and his plan for excavation shall reflect, the equipment and methods to be employed in the excavation. The prices established in the Proposal for the Work to be done will reflect all costs pertaining to the Work.

1.02 QUALITY ASSURANCE

- A. Testing laboratory employed by the County will make such tests as are deemed advisable. The Contractor shall schedule his work to permit a reasonable time for testing before placing succeeding lifts and shall keep the laboratory informed of his progress. Costs for initial testing shall be paid by the County; however, tests which have to be repeated because of the failure of the tested material to meet specification shall be paid for by the Contractor and the cost of re-testing shall be deducted from payments due the Contractor.
- B. Standards
 - 1. AASHTO: American Association of State Highway and Transportation Officials
 - 2. ANSI: American National Standards Institute
 - 3. ASCE: American Society of Civil Engineers
 - 4. ASTM: American Society for Testing and Materials
 - 5. AWWA: American Water Works Association
 - 6. OSHA 29 CFR Subpart P – Excavations and Trenches a) 1926.650, 1926.651, 1926.652
 - 7. OSHA 29 CFR Subpart J - a) 1910.146 for Confined Space Entry

1.03 JOB CONDITIONS

- A. Existing Utilities
 - 1. The Contractor is responsible for subsurface verification of existing utilities prior to construction. Locate existing utilities in the area of work in accordance with Sunshine State One Call regulations, Chapter 556, "Underground Facility Damage Prevention and Safety Act", FS.
 - 2. Should uncharted or incorrectly charted piping or other utility be encountered during excavation, notify the County. Keep all facilities in operation and repair damaged utilities to the satisfaction of the County.
 - 3. Damage and repair costs to such piping or utilities are the Contractor's responsibility.
 - 4. If utilities are to remain in place, the Contractor shall provide adequate means of protection.
- B. Test borings and the sub-surface exploration data if previously done on the site will be made available upon request and are for the Contractor's information only.

1.04 PROTECTION

- A. Sheeting and Bracing
 - 1. Requirements of the Trench Safety Act shall be adhered to at all times.

2. Furnish, put in place, and maintain such sheeting and bracing as may be required to support the sides of excavations, to prevent any movement which could in any way diminish the width of the excavation below that necessary for proper construction, to protect adjacent structures and power poles from undermining, and to protect workers from hazardous conditions or other damage. Such support shall consist of braced steel sheet piling, braced wood lagging and soldier beams or other acceptable methods. If the County is of the opinion that at any point sufficient or proper supports have not been provided, the County may order additional supports put in at the expense of the Contractor, and compliance with such order shall not relieve or release the Contractor from his responsibility for the sufficiency of such supports. Care shall be taken to prevent voids outside of the sheeting, but if voids are formed, they shall be immediately filled and compacted. Where soil cannot be properly compacted to fill a void, lean concrete shall be used as backfill at no additional expense to the County.
3. The Contractor shall construct the sheeting outside the neat lines of the foundation unless indicated otherwise for the method of operation. Sheeting shall be plumb and securely braced and tied in position. Sheeting and bracing shall be adequate to withstand all pressure to which the structure or trench will be subjected. Any movement or bulging which may occur shall be corrected by the Contractor at their own expense so as to provide the necessary clearances and dimensions.
4. Where sheeting and bracing is required to support the sides of excavations for structures, the Contractor shall engage a Professional Geotechnical Engineer, registered in the State of Florida, to design the sheeting and bracing. The sheeting and bracing installed shall be in conformity with the design, and the Professional Engineer shall provide certification of this.
5. The installation of sheeting, particularly by driving or vibrating, may cause distress to existing structures. The Contractor shall evaluate the potential for such distress and, if necessary, take all precautions to prevent distress of existing structures because of sheeting installation.
6. The Contractor shall leave in place to be embedded in the backfill all sheeting and bracing not shown on the Drawings but which the County may direct him in writing to leave in place at any time during the progress of the Work for the purpose of preventing damage to structures, utilities, or property, whether public or private. The County may direct that timber used for sheeting and bracing be cut off at any specified elevation.
7. All sheeting and bracing not left in place shall be carefully removed in such manner as not to endanger the construction or other structures, utilities, or property. All voids left or caused by withdrawal of sheeting shall be immediately refilled with sand by ramming with tools especially adapted to that purpose, or otherwise as may be directed by the County.
8. The right of the County to order sheeting and bracing left in place shall not be construed as creating any obligation on the County's part to issue such orders, and their failure to exercise this right shall not relieve the Contractor from liability for damages to persons or property occurring from or upon the Work occasioned by negligence or otherwise, growing out of a failure on the part of the Contractor to leave in place sufficient sheeting and bracing to prevent any caving or moving of the ground.

9. No wood sheeting is to be withdrawn if driven below mid-diameter of any pipe, and under no circumstances shall any wood sheeting be cut off at a level lower than 1-foot above the top of any pipe.

B. Pumping and Drainage:

1. The Contractor shall at all times during construction provide and maintain proper equipment and facilities to remove all water entering excavations, and shall keep such excavations dry so as to obtain a satisfactory undisturbed subgrade foundation condition until the fills, structures, or pipes to be built thereon have been completed to such extent that they will not be floated or otherwise damaged by allowing the water level to return to the natural level as stipulated in Section 02140 "Dewatering." The Contractor shall engage a Professional Geotechnical Engineer registered in the State of Florida to design the dewatering systems. The Contractor shall submit to the County for a plan for dewatering systems prior to commencing work. The dewatering system installed shall be in conformity with the overall construction plan, and the Professional Engineer shall provide certification of this. The Professional Engineer shall be required to monitor the performance of the dewatering systems during the progress of the Work and require such modifications as may be required to assure that the systems are performing satisfactorily.
2. Dewatering shall at all times be conducted in such a manner as to preserve the undisturbed bearing capacity of the subgrade soils at the proposed bottom of excavation and to preserve the integrity of adjacent structures. Dewatering by trench pumping will not be permitted if migration of fine grained natural material from bottom, sidewalls, or bedding material will occur.
3. Water entering the excavation from surface runoff shall be collected in shallow ditches around the perimeter of the excavation, drained to sumps, and pumped from the excavation to maintain a bottom free from standing water.
4. The Contractor shall take all additional precautions to prevent uplift of any structure during construction.
5. Permission to use any storm sewers or drains for water disposal purposes shall be obtained from the authority having jurisdiction. Any requirements and costs for such use shall be the responsibility of the Contractor. However, the Contractor shall not cause flooding by overloading or blocking up the flow in the drainage facilities, and he shall leave the facilities unrestricted and as clean as originally found. Any damage to facilities shall be repaired or restored as directed by the County or the authority having jurisdiction, at no cost to the County.
6. The Contractor shall prevent flotation by maintaining a positive and continuous operation of the dewatering system. The Contractor shall be fully responsible and liable for all damages which may result from failure of this system.
7. Removal of dewatering equipment shall be accomplished after compaction/density testing has been completed and the system is no longer required. The Contractor shall remove the material and equipment constituting the system.
8. The Contractor shall take all necessary precautions to preclude the accidental discharge of fuel, oil, or other contaminants in order to prevent adverse effects on groundwater quality.

1.05 TESTING AND INSPECTION SERVICE

- A. The County will provide a geotechnical testing and inspection service. The services include testing soil materials and quality control testing during filling and backfilling operations. Samples of soil materials shall be furnished to the testing service by the Contractor. The County shall pay costs of initial geotechnical testing. The Contractor shall pay for any subsequent testing required due to failure and laboratory stand-by charges incurred.
- B. The Contractor shall provide monthly density testing reports to the County during backfilling activities. Density testing reports not submitted in a timely manner shall result in rejection of the pipe installed and rejection of the density testing reports until such time that density re-testing is coordinated and repeated at the Contractors expense.
- C. Density testing scheduled subsequent to backfilling activities shall be coordinated with, and witnessed by the County. Failure by the Contractor to coordinate or have the County present shall result in rejection of the submitted density testing reports and re-testing at the Contractor's expense.
- D. Dewatering systems shall not be removed until compaction/density testing has been completed.

PART 2 - PRODUCTS

2.01 MATERIALS

- A. General:
 - 1. All fill material shall be subject to the review and acceptance of the County.
 - 2. All fill material shall be free of organic material, trash, or other objectionable material. The Contractor shall remove excess or unsuitable material from the job site.
- B. Common Fill Material: Common fill shall consist of mineral soil, substantially free of clay, organic material, muck, loam, wood, trash, and other objectionable material which may be compressible or which cannot be compacted properly. Common fill shall not contain stones larger than 3-1/2-inches in any dimension in the top 12-inches or 6-inches in any dimension in the balance of fill area. Common fill shall not contain asphalt, broken concrete, masonry, rubble or other similar materials. It shall have physical properties that allow it to be easily spread and compacted during filling. Additional common fill shall be no more than 12 % by weight finer than the No. 200 mesh sieve, unless finer material is approved for use in a specific location by the County. Select Common Fill shall be as specified as above from common fill, except that the material shall contain no stones larger than 1/2-inches in largest dimension, and shall be no more than 5 % by weight finer than the No. 200 mesh sieve.

C. Structural Fill: Structural fill shall be reasonably well graded sand to gravelly sand having the following gradation:

US Sieve Size	Percent Passing By Weight
No. 1	100
No. 4	75 - 100
No. 40	15 - 80
No. 100	0 - 30
No. 200	0 - 12

D. Class 1 Soils*: Manufactured angular, granular material, 1/4 to 1-1/2-inches (6 to 4 mm) size, including materials having significance such as crushed stone or rock, broken coral, crushed slag, cinders, or crushed shells. Sieve analysis for crushed stone is given below separately.

Crushed Stone: Crushed stone shall consist of clean mineral aggregate free from clay, loam or organic matter, conforming to ASTM C33 stone size No. 89 and with particle size limits as follows:

U.S. Sieve Size	% Passing By Weight
1/2	100
3/8	100
No. 4	20 - 25
No. 8	5 - 30
No. 16	0 - 10
No. 50	0 - 2

E. Class II Soils**:

1. GW: Well graded gravels and gravel-sand mixtures, little or no fines. Fifty percent or more retained on No. 4 sieve. More than 95 % retained on No. 200 sieve. Clean.
2. GP: Poorly graded gravels and gravel-sand mixtures, little or no fines. Fifty percent or more retained on No. 4 sieve. More than 95 % retained on No. 200 sieve. Clean.
3. SW: Well graded sands and gravelly sands, little or no fines. More than passes No. 4 sieve. More than 95 % retained on No. 200 sieve. Clean.
4. SP: Poorly graded sands and gravelly sands, little or no fines. More than 50 % passes No. 4 sieve. More than 95 % retained on No. 200 sieve. Clean.

*Soils defined as Class I materials are not defined in ASTM D2487.

**In accordance with ASTM D2487, less than 5 % pass No. 200 sieve.

- F. Coarse Sand: Sand shall consist of clean mineral aggregate with particle size limits as follows:

U.S. Sieve Size	Percent Passing By Weight
3/8	100
No. 10	85 – 100
No. 40	20 – 40
No. 200	0 - 12

- G. Other Material: All other material, not specifically described, but required for proper completion of the Work shall be selected by the Contractor and acceptable by the County.

PART 3 - EXECUTION

3.01 PREPARATION

A. Clearing:

1. The construction areas shall be cleared of all obstructions and vegetation including large roots and undergrowth within 10-feet of the lines of the excavation.
2. Strip and stockpile topsoil on the site at the location to be determined by the County.

3.02 EXCAVATION

- A. General: Excavations for roadways, structures, and utilities must be carefully executed in order to avoid interruption of utility service.

B. Excavating for Roadways/Structures/Utilities:

1. Excavation shall be made to such dimensions as will give suitable room for building the foundations and the structures, for bracing and supporting, for pumping and draining, and for all other work required.
 - a. Excavation for precast or prefabricated structures shall be carried to an elevation 2-feet lower than the proposed outside bottom of the structure to provide space for the select backfill material. Prior to placing the select backfill, the excavation shall be measured by the County to verify that the excavation has been carried to the proper depth and is reasonably uniform over the area to be occupied by the structure.
 - b. Excavation for structures constructed or cast in place in dewatered excavations shall be carried down to the bottom of the structure where dewatering methods are such that a dry excavation bottom is exposed and the naturally occurring material at this elevation leveled and left ready to receive construction. Material disturbed below the founding elevation in dewatered excavations shall be replaced with Class B concrete.
 - c. Footings: Cast-in-place concrete footing sides shall be formed immediately after excavation.
2. Immediately document the location, elevation, size, material type and function of all new subsurface installations, and utilities encountered during the course of construction.

3. Excavation equipment operators and other concerned parties shall be familiar with subsurface obstructions as shown on the Drawings and should anticipate the encounter of unknown obstructions during the course of the Work.
4. Encounters with subsurface obstructions shall be hand excavated.
5. Excavation and dewatering shall be accomplished by methods that preserve the undisturbed state of subgrade soils. Subgrade soils which become soft, loose, "quick" or otherwise unsatisfactory for support of structures as a result of inadequate dewatering or other construction methods shall be removed and replaced by crushed stone as required by the County at the Contractor's expense.
6. The bottom of excavations shall be rendered firm and dry before placing any piping or structure.
7. All pavements shall be cut with saws or approved power tools prior to removal.
8. Excavated material shall be stockpiled in such a manner as to prevent nuisance conditions. Surface drainage shall not be hindered. Excavated material not suitable for backfill shall be removed from the site and disposed of by the Contractor.

3.03 DRAINAGE

- A. The Contractor shall at all times during construction provide and maintain proper equipment and facilities to remove promptly and dispose of properly all water entering excavations, and keep such excavations dry so as to obtain a satisfactory undisturbed subgrade foundation condition. The dewatering method used shall prevent disturbance of earth below grade.
- B. All water pumped or drained from the Work shall be disposed of in a suitable manner without undue interference with other work, without damage to surrounding property, and in accordance with pertinent rules and regulations.
- C. No construction, including pipe laying, shall be allowed in water. No water shall be allowed to contact masonry or concrete within 24-hours after being placed. The Contractor shall constantly guard against damage due to water and take full responsibility for all damage resulting from his failure to do so.
- D. The Contractor will be required at his expense to excavate below grade and refill with crushed stone (gradation 57 or 89) or other acceptable fill material if the County determines that adequate dewatering has not been provided.

3.04 UNDERCUT

- A. If the bottom of any excavation is below that shown on the Drawings or specified because of Contractor error, convenience, or unsuitable subgrade due the Contractor's excavation methods, he shall refill to normal grade with fill at his own cost. Fill material and compaction method shall be approved by the County.

3.05 FILL AND COMPACTION

- A. Compact and backfill excavations and construct embankment according to the following schedule. (Modified Proctor standard shall be ASTM D-1557):

STRUCTURES AND ROADWORK

Area	Material	Compaction
Beneath Structures	Structural Fill	12-inch lifts, compacted to 98% maximum density as determined by AASHTO T-180. Fill Should not be placed over any in-place soils until those deposits have been compacted to 98% Modified Proctor.
Around Structures	Structural Fill	12-inch lifts, 95% of maximum density as determined by AASHTO T-180. Rubber Tire or vibratory plate compactors shall be used
Beneath Paved Surfaces	Common Fill	12-inch lifts, 98% by maximum density as determined by AASHTO T-180 or as required by the FDOT Standards.
Open Areas	Common Fill	12-inch lifts, 95% by maximum density as determined by AASHTO T-180.

- B. Pipe shall be laid in open trenches unless otherwise indicated on the Drawings or elsewhere in the Contract Documents.
- C. Excavations shall be backfilled to the original grade or as indicated on the Drawings. Deviation from this grade because of settling shall be corrected. The backfill operation shall be performed to comply with all rules and regulations and in such a manner that it does not create a nuisance or safety hazard.
- D. Embankments shall be constructed true to lines, grades, and cross sections shown on the plans or ordered by the County. Embankments shall be placed in successive layers of not more than 8-inches in thickness, loose measure, for the full width of the embankment. As far as practicable, traffic over the Work during the construction phase shall be distributed so as to cover the maximum surface area of each layer.
- E. If the Contractor requests approval to backfill material utilizing lifts and/or methods other than those specified herein, such request shall be in writing to the County. Acceptance will be considered only after the Contractor has performed tests, at the Contractor's expense, to identify the material used and density achieved throughout the backfill area utilizing the method of backfill requested. The County's acceptance shall be in writing.
- F. One compaction test location shall be required for each 300 linear feet of pipe and for every 100 square feet of backfill around structures as a minimum. The County may determine that more compaction tests are required to certify the installation depending on field conditions. The locations of the compaction tests within the trench shall be in conformance with the following schedule:
1. At least one test at the spring line of the pipe.

2. At least one test for each 12-inch layer of backfill within the pipe bedding zone for pipes 24-inches and larger.
3. One test at an elevation of 1-foot above the top of pipe.
4. One test for each 2-feet of backfill placed from 1-foot above the top of the pipe to finished grade elevation.
5. Density testing is required for sanitary sewer manholes. Tests shall be staggered around the manhole within 3-feet of the structure's outside diameter.
 - a. First test shall be 1-foot above the structure base.
 - b. Second test shall be 2-feet above the first test and subsequent tests every 2-feet up the finished grade.
6. The Contractor shall provide additional compaction and testing prior to commencing further construction if the County's testing reports and inspection indicate that the fill has been placed below specified density.
7. The Contractor shall coordinate testing with the County approved testing laboratory and shall provide monthly test results to the County in a timely manner during construction activities. Density testing scheduled subsequent to backfilling activities shall be coordinated with the County and witnessed by the County representative. Failure by the Contractor to coordinate or have the County representative present shall result in rejection of the submitted density testing reports and re-testing at the Contractor's expense. Density testing reports not submitted in a timely manner shall result in rejection of the pipe installed and rejection of the density testing reports until such time that density re-testing is coordinated and repeated at the Contractor's expense as deemed necessary by the County's representative.
8. Dewatering systems shall not be removed until compaction/density testing has been completed.

END OF SECTION

SECTION 02576
CONCRETE SIDEWALKS AND DRIVEWAYS

PART 1 - GENERAL

1.01 DESCRIPTION

- A. Scope of Work: Constructing new concrete sidewalks, driveways, and curb and gutters as shown on the Drawings.

1.02 QUALITY ASSURANCE

- A. Codes and Standards: Comply with applicable sections of F.D.O.T. Specifications and local governing regulations.
- B. The mixture, placement, and curing of all concrete work shall be in accordance with F.D.O.T. Specifications.

1.03 SHOP DRAWINGS AND SUBMITTALS

- A. Submittals shall be submitted to the County for review and acceptance prior to construction in accordance with the General Conditions and specifications Section 01300 "Submittals."
- B. Furnish manufacturer's product data, design mixes, test reports, and materials certifications.

1.04 JOB CONDITIONS

- A. Traffic Control: Maintain access for vehicular and pedestrian traffic as required for other construction activities, as specified under Section 01570 "Maintenance of Traffic."
- B. Utilize flagman, barricades, warning signs, and warning lights as required.

1.05 GUARANTEE

- A. All restored areas within the public right-of-way shall be guaranteed for 1-year after final acceptance. In the event of cracked or broken concrete surfaces, the Contractor shall make the necessary repairs to restore the concrete within 10-calendar days after notification by the County. The cost of such repairs shall be paid by the Contractor.

PART 2 - PRODUCTS

2.01 GENERAL

- A. All material supplied shall be one of the products specified in Appendix D "List of Approved Products" appended to these technical specifications.

2.02 CONCRETE MATERIALS

- A. Forms: Steel or wood for each type of use of size and strength to resist movement during concrete placement and to retain horizontal and vertical alignment until removal. Use straight forms, free of distortion and defects.
 - 1. Use flexible spring steel forms or laminated boards to form radius bends as required.
 - 2. Coat forms with a non-staining form release agent that will not discolor or deface the surface of the concrete.
- B. Fibermesh Reinforcement: Fibermesh reinforcement fibers shall be 2-inches to 3-inches collated polypropylene fibers. Fibers shall be in strict accordance with the manufacturer recommendations and within the time as specified in ASTM C94, Type III 4.13 and applicable building codes.
- C. Concrete Materials: Comply with requirements of F.D.O.T. Section 347 for concrete materials, admixtures, bonding materials, curing materials, and others as required.
- D. Epoxy Resin Grout: Type N as specified in F.D.O.T. Section 926.
- E. Aggregate, brick, or other material required to match existing driveway or walk shall be as approved by the County.

2.03 CONCRETE MIX, DESIGN, AND TESTING

- A. Comply with requirements of applicable F.D.O.T. Section 347 for concrete mix design, sampling and testing, and quality control, and as herein specified.
- B. Design the mix to produce standard weight concrete consisting of Portland cement, aggregate, air entraining admixture, and water to produce the following properties.
 - 1. Compressive Strength: Class B, 3,000 psi for walks and curbs.
 - 2. Compressive Strength: Class A, 4,000 psi for driveways.
 - 3. Air Content: 3% to 6% .
- C. Concrete slump shall not exceed plus or minus 1-inch from approved design slump.

PART 3 - EXECUTION

3.01 CONCRETE SIDEWALK, DRIVEWAY, AND CURB AND GUTTER

A. Surface Preparation:

1. Remove loose material from the compacted sub base surface immediately before placing concrete.
2. Proof-roll prepared sub base surface to check for unstable areas and the need for additional compaction. Do not begin paving work until such conditions have been corrected and are ready to receive paving.

B. Form Construction:

1. Set forms to the required grades and lines, rigidly braced and secured. Install sufficient quantity of forms to allow continuous progress of the Work and so that forms can remain in place at least 24-hours after concrete placement.
2. Check completed form work for grade alignment to the following tolerances:
 - a. Top of forms not more than 1/8-inch in 10-feet.
 - b. Vertical face on longitudinal axis, not more than 1/4-inch in 10-feet.
3. Clean forms for reuse immediately after use, and coat with form release agent as often as required to ensure separation from concrete without damage.

C. Concrete Placement:

1. Do not place concrete until sub base and forms have been checked for line and grade. Moisten if required to provide a uniform dampened condition at the time concrete is placed. Do not place concrete around manholes or other structures until they are completed to required finish elevation and alignment. Use special colors or aggregate as required to match existing material.
2. Place concrete using methods which prevent segregation of the mix. Consolidate concrete along the face of forms and adjacent to transverse joints with an internal vibrator. Keep vibrator away from joint assemblies, reinforcement, or side forms. Use only square-faced shovels for hand spreading and consolidation. Consolidate with care to prevent dislocation of reinforcing, dowels, and joint devices. Do not use vibrators to push or move concrete in forms or chute.
3. Deposit and spread concrete in a continuous operation between transverse joints, as far as possible. If interrupted for more than 1/2-hour, place a construction joint.
4. An automatic machine may be used for sidewalk or curb and gutter placement at Contractor's option. If machine placement is to be used, submit revised mix design and laboratory test results which meet or exceed the minimum herein specified. Machine placement must produce sidewalks and/or curbs and gutters to the required cross-section, lines, grades, finish, and jointing as specified for formed concrete. If results are not acceptable, remove and replace with formed concrete as specified.

5. Joints: Construct expansion, weakened-plane (contraction), and construction joints true-to-line with face perpendicular to surface of the concrete, unless otherwise indicated. Construct transverse joints at right angles to the centerline, unless otherwise indicated. When joining existing structures place transverse joints to align with previously placed joints, unless otherwise indicated.
 - a. Weakened-Plane Joints: Provide weakened-plane (contraction) joints sectioning concrete into areas as shown on the Drawings. Construct weakened plane joints for a depth equal to at least 1/4 concrete thickness, by sawing within 24-hours of placement or formed during finishing operations. Place joints at intervals not to exceed 10-feet if not otherwise indicated.
 - b. Construction Joints: Place construction joints at the end of all pours and at locations where placement operations are stopped for a period of more than 1/2-hour, except where such pours terminate at expansion joints. Construction joints shall be as shown or, if not shown, use standard metal keyway-section form of appropriate height.
 - c. Expansion Joints:
 - (1) Provide premolded joint filler for expansion joints abutting concrete curbs, catch basin, manholes, inlets, structures, walks, and other fixed objects, unless otherwise indicated.
 - (2) Locate expansion joints at 12-feet on center for concrete walks unless otherwise indicated.
 - (3) Extend joint fillers full-width and depth of joint, and not less than 1/2-inch below finished surface where joint sealer is indicated. If no joint sealer, place top of joint filler flush with finished concrete surface.
 - (4) Furnish joint fillers in one-piece lengths for the full width being placed, wherever possible. Where more than one length is required, lace or clip joint filler sections together. Pieces shorter than 4-inches shall not be used unless specifically shown as such.
 - (5) Protect the top edge of the joint filler during concrete placement with a metal cap or other temporary material. Remove protection after concrete has been placed on both sides of joint.
 - (6) Fillers and Sealants: Comply with the requirements of these specifications for preparation of joints, materials installation, and performance, and as herein specified.

D. Concrete Finishing:

1. After striking-off and consolidating concrete, smooth the surface by screening and floating. Use hand methods only where mechanical floating is not possible. Adjust the floating to compact the surface and produce a uniform texture.
2. After floating, test surface for trueness with a 20-foot straightedge. Variations exceeding 1/3-inch for any two points within 10-feet shall not be acceptable. Distribute concrete as required to remove surface irregularities, and refloat repaired areas to provide a continuous smooth finish.
3. Work edges of slabs, gutters, back top edge of curb, and formed joints with an edging tool, and round 10-1/2-inch radius, unless otherwise indicated. Eliminate any tool marks on concrete surface.

4. After completion of floating and when excess moisture or surface sheen has disappeared, broom finish sidewalks by drawing a fine-hair broom across concrete surface, perpendicular to a line of pedestrian traffic. If the existing material has another finish, match existing finish.
5. Do not remove forms for 24-hours after concrete has been placed. After form removal, clean ends of joints and point up any minor honeycombed areas.

E. Curing:

Protect and cure finished concrete paving and walks, complying with applicable requirements of F.D.O.T. Section 350. Use moist-curing methods for initial curing of approved concrete curing compounds whenever possible.

F. Repairs and Protections:

1. Repair or replace broken or defective concrete, as directed by the County.
2. Drill test cores where directed by the County, when necessary to determine magnitude of cracks or defective areas. Fill drilled core holes in satisfactory pavement areas with Portland cement concrete bonded to pavement with epoxy resin grout.
3. Protect concrete from damage until acceptance of work. When construction traffic is permitted, maintain pavement as clean as possible by removing surface stains and spillage of materials as they occur.
4. Sweep concrete pavement and wash free of stains and discolorations, dirt, and other foreign material just prior to final inspection.

3.02 FIELD QUALITY CONTROL

- A. General: Repair or remove and replace unacceptable concrete sidewalk, driveways, or curb and gutter as directed by the County.
- B. Surface Elevation: Actual surface elevations shall be within ± 0.05 feet of specified or indicated elevations at any given point. Surface elevations between any 2 given points shall be interpolated from a direct line between the 2 points. Surfaces exceeding actual elevation tolerances of more than ± 0.05 feet at any 2 points within a distance of 15-feet will not be acceptable.

END OF SECTION

1

THIS PAGE LEFT BLANK INTENTIONALLY

SECTION 02578
SOLID SODDING

PART 1 - GENERAL

1.01 DESCRIPTION

- A. Scope of Work: Establishing a stand of grass by furnishing and placing grass sod. Included are fertilizing, watering, and maintenance as required to assure a healthy stand of grass. Solid sodding shall be placed on all slopes greater than 4:1, within 10-feet of all proposed structures, and in all areas where existing grass or sod (regardless of it's condition) is removed or disturbed by Contractor's operation unless otherwise specified or shown on the Drawings.

1.02 SHOP DRAWINGS AND SUBMITTALS

- A. Submittals shall be submitted to the County for review and acceptance prior to construction in accordance with the General Conditions and specifications Section 01300 "Submittals."
 - 1. A certification of sod quality by the producer shall be delivered to the County ten days prior to use.

PART 2 - PRODUCTS

2.01 GENERAL

- A. All material supplied shall be one of the products specified in Appendix D "List of Approved Products" appended to these technical specifications.

2.02 GRASS SOD

- A. Grass sod for the road rights-of-way shall be of variety to match the existing adjacent area and shall be well matted with grass roots. The sod shall be taken up in rectangles, preferably 12-inch by 24-inch, shall be a minimum of 2-inches in thickness, and shall be live, fresh, and uninjured at the time of planting.
- B. Grass sod for restoration of new construction sites and/or areas disturbed by construction on existing sites shall be St. Augustine well matted with grass roots. The sod shall be taken up in rectangles, preferably 12-inch by 24-inch, shall be a minimum of 2-inches in thickness, and shall be live, fresh, and uninjured at the time of planting.

- C. It shall be reasonably free of weeds and other grasses and shall have a soil mat of sufficient thickness adhering firmly to the roots to withstand all necessary handling. The sod shall be planted as soon as possible after being dug and shall be shaded and kept moist until it is planted.

2.03 FERTILIZER

- A. Commercial fertilizers shall comply with the state fertilizer laws.
- B. The numerical designations for fertilizer indicate the minimum percentages (respectively) of (1) total nitrogen, (2) available phosphoric acid, and (3) water-soluble potash contained in the fertilizer.
- C. The chemical designation of the fertilizer shall be 6-6-6. At least 50% of the nitrogen shall be derived from organic sources. At least 50 % of the phosphoric acid shall be from normal super phosphate or an equivalent source, which will provide a minimum of two units of sulfur. The amount of sulfur shall be indicated on the quantitative analysis card attached to each bag or other container.

2.04 WATER FOR GRASSING

- A. The water used in the sodding operations shall be by the Contractor as approved by the County.

PART 3 - EXECUTION

3.01 PREPARATION OF GROUND

- A. The area over which the sod is to be placed shall be scarified or loosened to a depth and then raked smooth and free from debris. Where the soil is sufficiently loose and clean, the County, at its discretion, may authorize the elimination of ground preparation.

3.02 APPLICATION OF FERTILIZER

- A. Before applying fertilizer, the soil pH shall be brought to a range of 6.0 - 7.0.
- B. The fertilizer shall be spread uniformly over the area to be sodded at the rate of 700-pounds per acre, or 16-pounds per 1,000 square feet, by a spreading device capable of uniformly distributing the material at the specified rate. Immediately after spreading, the fertilizer shall be mixed with the soil to a depth of approximately 4-inches.
- C. On steep slopes, where the use of a machine for spreading or mixing is not practicable, the fertilizer shall be spread by hand and raked in and thoroughly mixed with the soil to a depth of approximately 2-inches.

3.03 PLACING SOD

- A. The sod shall be placed on the prepared surface, with edges in close contact and shall be firmly and smoothly embedded by light tamping with appropriate tools.
- B. Where sodding is used in drainage ditches, or on slopes of 4:1 or greater, the setting of the pieces shall be staggered to avoid a continuous seam along the line of flow. Along the edges of such staggered areas, the offsets of individual strips shall not exceed 6-inches. In order to prevent erosion caused by vertical edges at the outer limits, the outer pieces of sod shall be tamped so as to produce a featheredge effect.
- C. On slopes greater than 2:1, the Contractor shall, if necessary, prevent the sod from sliding by means of wooden pegs driven through the sod blocks into firm earth at suitable intervals.
- D. Sod which has been cut for more than 72-hours shall not be used unless specifically authorized by the County after the inspection thereof. Sod which is not planted within 24-hours after cutting shall be stacked in an approved manner, maintained, and properly moistened. Any pieces of sod that, after placing, show an appearance of extreme dryness shall be removed and replaced by fresh, uninjured pieces.
- E. Sodding shall not be performed when weather and soil conditions are, in the County's opinion, unsuitable for proper results.

3.04 WATERING

- A. The areas on which the sod is to be placed shall contain sufficient moisture, as determined by the County, for optimum results. After being placed, the sod shall be kept in a moist condition to the full depth of the rooting zone for at least 2-weeks. Thereafter, the Contractor shall apply water as needed until the sod roots and starts to grow for a minimum of 60-days (or until final acceptance, whichever is latest).

3.05 MAINTENANCE

- A. The Contractor shall maintain, at his expense, the sodded areas in a satisfactory condition until final acceptance of the Project. Such maintenance shall include repairing of any damaged areas and replacing areas in which the establishment of the grass stand does not appear to be developing satisfactorily.
- B. Replanting or repair necessary due to the Contractor's negligence, carelessness, or failure to provide routine maintenance shall be at the Contractor's expense.

END OF SECTION

1

THIS PAGE LEFT BLANK INTENTIONALLY

SECTION 02661
WASTEWATER FORCE MAINS

PART 1 - GENERAL

1.01 WORK INCLUDED

- A. The work under this Section includes providing a complete system for wastewater transmission pressure piping and appurtenant items.

1.02 QUALITY ASSURANCE

A. Design Requirements

1. Piping shall be laid with a minimum cover of 36-inches below finished grade, unless otherwise indicated.
2. Pipelines shall be constructed of the materials indicated on the Drawings.
3. All force mains shall be installed with a continuous insulated 10-gauge copper wire. Wire shall terminate at the top of each valve and be capable of extending 18-inches above the top of the box.
4. All PVC force mains shall be solid green. All lettering shall appear legibly on the pipe and shall run the entire length of the pipe. Lettering shall read as is acceptable for the intended use.
5. Flanged ductile iron used in valve vaults or above ground piping at pump stations shall be Protecto 401 lined and coated per specification Section 09901, "Coatings and Linings." Flanged DIP shall be epoxy coated from the factory and shall not be coated with bitumastic or asphaltic exterior coatings.

- B. Pipe Inspection: The Contractor shall obtain from the pipe manufacturers a certificate of inspection to the effect that the pipe and fittings supplied for this contract have been inspected at the plant and that they meet the requirements of these specifications. All pipe and fittings shall be subjected to visual inspection at time of delivery and just before they are lowered into the trench to be laid. Joints or fittings that do not conform to these specifications will be rejected and must be removed immediately by the Contractor. The entire product of any plant may be rejected when, in the opinion of the County, the methods of manufacture fail to secure uniform results, or where the materials used produce inferior pipe or fittings.

- C. Prevention of Electrolysis: Where shown on Drawings or deemed necessary, electrolytic action through the contact of dissimilar metals shall be prevented by either;

1. The separation of one material from the other by means of an insulating or dielectric coupling (polyethylene wrap), or
2. The use of alternative materials, as directed by the County

1.03 SHOP DRAWINGS AND SUBMITTALS

- A. Submittals shall be submitted to the County for review and acceptance prior to construction in accordance with the General Conditions and specifications Section 01300 "Submittals."
 - 1. Certified test reports on pipe
 - 2. Details of restrained and flexible joints
 - 3. Detailed laying schedule for pipe
 - 4. Valves and valve boxes
- B. Acceptance of Material: The County reserves the right to sample and test any pipe or fitting after delivery and to reject all pipe and fittings represented by any sample which fails to comply with the specified requirements.

1.04 JOB CONDITIONS

- A. Water in Excavation: Water shall not be allowed in the trenches while the pipes are being laid and/or tested. The Contractor shall not open more trenches than the available pumping facilities are able to dewater to the satisfaction of the County. The Contractor shall assume responsibility for disposing of all water so as not to injure or interfere with the normal drainage of the territory in which he is working. In no case shall the pipelines being installed be used as drains for such water, and the ends of the pipe shall be kept properly and adequately blocked during construction by the use of acceptable stoppers and not by improvised equipment. All necessary precautions shall be taken to prevent the entrance of mud, sand, or other obstructing matter into the pipelines. If on completion of the Work any such material has entered the pipelines, it must be cleaned as directed by the County so that the entire system will be left clean and unobstructed.

PART 2 - PRODUCTS

2.01 GENERAL

- A. All material supplied shall be one of the products specified in Appendix D "List of Approved Products" appended to these technical specifications.

2.02 MATERIALS

- A. Pipe Fittings, Valves, and Ancillary Equipment shall be installed as shown on the Drawings and as specified in Division 15.
- B. Additional Work: Additional items of construction, necessary for the complete installation of the systems, shall conform to specific details shown on the Drawings and shall be constructed of first-class materials conforming to the applicable portions of these specifications.

PART 3 - EXECUTION

3.01 PREPARATION

- A. Bedding: Upon satisfactory installation of the pipe bedding material as specified in Section 02220 "Excavating, Backfilling and Compacting", a continuous trough for the pipe barrel and recesses for the pipe bells or couplings shall be excavated by hand digging. The pipe shall be laid in the prepared trench, true to line and grade, the pipe barrel shall receive continuous, uniform support and no pressure will be exerted on the pipe joints from the trench bottom.
- B. Cleanliness: The interior of the pipes shall be thoroughly cleaned of all foreign matter before being gently lowered into the trench and shall be kept clean during laying operations by means of plugs or other methods acceptable by the County. During suspension of work for any reason at any time, a suitable stopper shall be placed in the end of the pipe last laid to prevent mud or other foreign material from entering the pipe.

3.02 INSTALLATION

- A. Pipe Identification/Location
 1. All PVC wastewater mains shall be solid green in color. All lettering shall appear legibly on the pipe and shall run the entire length of the pipe. Lettering shall read as is acceptable for the intended use.
 2. All HDPE wastewater mains shall be either a solid green or black with four co-extruded equally spaced green stripes of the same material as the pipe. Stripes painted on the pipe outside surface shall not be acceptable.
 3. If main is located over 30-feet from the edge of the pavement or in an easement, the Contractor shall install 4-inch diameter schedule 80 PVC utility pipe line markers over the pipe alignment at 1,000-foot intervals, at all valves, and at all locations where fittings deflect the pipe alignment in the horizontal plane. Utility pipeline markers shall include a decal and shall be colored purple for reclaimed water service.
 4. All mains (PVC and HDPE) shall be installed with a continuous, insulated 10-gauge copper wire installed directly above the pipe for location purposes. Locate wire shall terminate in a test station box and be capable of extending 12-inches above the top of the box. Directionally drilled pipe shall be installed with two insulated 10-gauge copper wires.
- B. Pipe:
 1. Gradient: Lines shall be laid straight, and depth of cover shall vary to provide uniform gradient or slope to pipe, whether grading is completed or proposed at time of pipe installation. When a grade or slope is shown on the Drawings, batter boards with string line paralleling design grade, or other previously approved means, shall be used by the Contractor to assure conformance to required grade.

2. Pipe Joint Deflection: No joint deflection or pipe bending is allowed in PVC pipe. The maximum allowable tolerance in the joint due to variances in installation is 0.75° (degrees), (3-inches per joint per 20-ft stick of pipe). No bending tolerance in the pipe barrel shall be acceptable. Alignment changes shall be made with sleeves and fittings as shown in Drawings. Deflection in fittings and sleeves shall not exceed 75% of the limits recommended by the fitting manufacturer.
3. Rejects: Any pipe found defective shall be immediately removed from the site and replaced with sound pipe at the Contractor's expense.
4. Joint Compounds: No sulfur base joint compound shall be used.
5. Thrust restraints shall be accomplished by the use of mechanical restraining devices unless specifically identified otherwise on the Drawings or herein. Restraining devices are specified in Section 15064 "Polyvinyl Chlorine Pipe and Fittings", respectfully.

C. Installing Valves and Boxes

1. Valves: Valves shall be carefully inspected, opened wide and then tightly closed and the various nuts and bolts shall be tested for tightness. Plug valves shall have the disc shaft installed horizontally with the plug rotating upward to the top of the valve. Any valve that does not operate correctly shall be removed and replaced.
2. Valve Boxes: Valve boxes and riser shall be centered over the operating nuts of the valves with a centering ring or disc so as to permit a valve key to be fitted easily to the operating nut. In unpaved areas, valve boxes shall be set to conform to the level of the finished surface and held in position by a concrete collar placed under the support flange as shown on the Drawings. The valve box shall not transmit surface loads to the pipe or valve. Extensions or risers for valve boxes shall be an integral part of the box. No cut sections of D.I. or PVC pipe shall be used in extending the box to its proper height. Care shall be taken to prevent earth and other material from entering the valve box. Any valve box which is out of alignment or whose top does not conform to the finished ground surface shall be dug out and reset. Before final acceptance of the Work all valve boxes shall be adjusted to finish grade.

D. Concrete Encasement

1. Concrete encasement shall be constructed in accordance with details shown on the Drawings and shall be constructed of Class C concrete. Encasement shall be constructed where
 - a. As indicated on the Drawings
 - b. As directed by the County
2. The points of beginning and ending of pipe encasement shall be not more than 6-inches from a pipe joint to protect the pipe from cracking due to uneven settlement of its foundation or the effects of superimposed live loads.
3. Concrete Collar: Each valve installed in an unimproved area (outside of pavement, driveways or sidewalks) shall require a 24-inch x 24-inch x 6-inch concrete pad or collar as shown in the Drawings.

- E. Flush Out Connections: Flush out connections shall be installed at the locations as determined by the County and be full pipe size to accommodate a full diameter flush for pipes 12-inches and smaller or a swab for pipes greater than 12-inches.

- F. Backfilling: Backfilling shall be in accordance with Section 02220 "Excavating, Backfilling and Compacting" of these specifications.

3.03 CLEANING

- A. General: At the conclusion of the Work the Contractor shall thoroughly clean the new pipe lines by flushing with water or other means to remove all dirt, stones or other material which may have entered the line during the construction period.
- B. Flushing 12-inch pipes and less: Flushing to remove all sand and other foreign matter from pipelines shall only be permitted for mains 12-inches and smaller. Flushing shall be accomplished through full pipe size connections at full pipe depth. The velocity of the flushing water shall be at least 4-feet per second. Flushing shall be terminated at the direction of the County. The Contractor shall dispose of the flushing water without causing a nuisance or property damage. The Contractor shall arrange and pay for the source of flushing water with the County or others.
- C. Swabbing in lieu of flushing: New mains may be hydraulically or pneumatically cleaned with a polypropylene swabbing device to remove dirt, sand and debris from main. If swabbing access and egress points are not provided in the design drawings, it will be the responsibility of the Contractor to provide temporary access and egress points for the cleaning, as required. Passage of cleaning poly swabs through the system shall be constantly monitored, controlled and all poly swabs entered into the system shall be individually marked and identified so that the exiting of the poly swabs from the system can be confirmed. Cleaning of the system shall be done in conjunction with the initial filling of the system for its hydrostatic test. After initial slow-fill, pipe shall sit full for 24 hours to facilitate cleaning and collection of debris from interior of pipe. The Contractor shall insert flexible polyurethane foam swabs (2-pounds per cubic foot density) complete with rear polyurethane drive seal, into the first section of pipe. The swabs shall remain there until the pipeline construction is completed. The line to be cleaned shall only be connected to the existing distribution system at a single connection point. Locate and open all new in-line valves beyond the point of connection on the pipeline to be cleaned during the swabbing operation. At the receiver or exit point for the poly swab, the Contractor is responsible for creating a safe environment for collection of debris, water and the swab. Considerations shall be made for protecting surrounding personnel and property and safe retrieval of the swab. Only County personnel shall operate the supply valve from the existing distribution system. Cleaning and flushing shall be accomplished by propelling the swab down the pipeline to the exit point with potable water. Flushing shall continue until the water is completely clear and swab is retrieved.

3.04 FIELD QUALITY CONTROL

- A. Correction of Non-Conforming Work: All non-conforming work shall be repaired or replaced by the Contractor at no additional expense to the County. Non-conforming work shall be defined as failure to adhere to any specific or implied directive of this Project Manual and/or the Drawings, including but not limited to pipe not laid true to the lines and grades as shown on the Drawings, damaged or unacceptable materials, misalignment or diameter ring deflection in pipe due to bedding or backfilling, visible or detectable leakage and failure to pass any specified test or inspection.
- B. Pressure and Leakage Tests of Pressure Piping
1. General: The Contractor shall perform hydrostatic pressure and leakage tests on all pressure piping. Tests shall be conducted on segments between valves and no more than 2,000 linear feet is to be tested at one time unless otherwise acceptable by the County.
 2. Standard: AWWA C600, Section 5 (DI pipe) and AWWA C605 Section 7 (PVC pipe) with the exceptions required herein and the exception that the Contractor shall furnish all gauges, meters, pressure pumps and other equipment needed to test the lines.
 3. Hydrostatic Pressure Test
 - a. Test Pressure: Test pressure will be 50% above the normal working pressure, but not less than 100-psi, unless otherwise noted on the Drawings.
 - b. Test Duration: Test shall be for a period of 2-hours. If during the test, the integrity of the tested line is in question, the County may require a 6-hour pressure test.
 - c. Air Release: Corporation cocks at least 3/4-inch in diameter, pipe riser and angle globe valves shall be provided at each dead-end to bleed air from the line.
 4. Hydrostatic Leakage Test
 - a. General: Following the pressure test, the Contractor shall perform the leakage test. The line shall be filled with water and all air removed for the test. The Contractor shall provide a pump to maintain the test pressure for the entire test period.
 - b. Test Pressure: Maximum operating pressure as determined by the County but not less than 100-psi unless otherwise noted.
 - c. Test duration: 2-hours.
 - d. Allowable leakage:
$$L = \frac{SD(P)^{0.5}}{148,000}$$

L = Allowable leakage (gallons per hour)
S = Length of pipe tested (feet)
D = Nominal diameter of pipe (inches)
P = Average test pressure maintained (psig)
 - e. Visible Leakage: All leaks evident at the surface shall be repaired and leakage eliminated regardless of the measured total leakage.
 - f. Leakage Measurement: The amount of water required to maintain the test pressure is the leakage.

END OF SECTION

SECTION 02761
CLEANING SANITARY SEWER SYSTEMS

PART 1 - GENERAL

1.01 SCOPE OF WORK

- A. The Work covered in this section consists of cleaning sewer lines and manholes prior to the internal television inspection(s) for new or existing wastewater systems.
- B. Gravity Main and Sewer Lateral Cleaning: The intent of gravity main cleaning is to remove debris that may be causing a reduction in flow capacity, potential sewer backups, or that limits the ability to evaluate the structural condition of the pipe segment. On all sewers, the Contractor shall perform sewer-cleaning work to an acceptable level as necessary to perform a thorough television inspection of the sewer. An acceptable level is defined as the removal of all debris throughout the pipe segment cleaned. If the pipe condition is such that cleaning may cause a potential collapse, then the pipe shall be televised without attempting to clean it pending approval by the County.
- C. Water for Cleaning: The Contractor will be responsible for obtaining a transient water meter and paying for water used during course of cleaning.
- D. Recovering of Equipment: The Contractor will be responsible for recovering any equipment that becomes lodged or lost in the pipeline. The Contractor will be responsible for all costs associated with required evacuation, restoration of roads and easements, and repairs to pipes and manholes as needed to restore the pipeline and appurtenances back to their original conditions.

1.02 CLEANING EQUIPMENT

- A. Hydraulically Propelled Equipment: The equipment used shall be of a movable dam type and be constructed in such a way that a portion of the dam may be collapsed at any time during the cleaning operation to protect against flooding of the sewer. The movable dam shall be equal in diameter to the pipe being cleaned and shall provide a flexible scraper around the outer periphery for grease removal. Special precautions to prevent flooding of the sewers and public or private property shall be taken at all times.
- B. High-Velocity Jet (Hydro-Cleaning) Equipment: All high-velocity sanitary sewer cleaning equipment shall be constructed for ease and safety of operation. The equipment shall have a selection of 2 or more high-velocity nozzles. The nozzles shall be capable of producing a scouring action from 15° to 45° (degrees) in all size mains. Equipment shall also include a high-velocity gun for washing and scouring manhole walls and floor. The gun shall be capable of producing flows from a fine spray to a solid stream. The equipment shall carry its own water tanks, auxiliary engines, pumps, and hydraulically driven hose reel.

- C. Mechanically Powered Equipment: Bucket machines shall be in pairs with sufficient power to perform the Work in an efficient manner. Machines shall be belt operated or have an overload device. Machines with direct drive that could cause damage to the pipe will not be used. A power rodding machine shall be either a sectional or continuous rod type capable of holding a minimum of 750-feet of rod. The rod shall be heat-treated steel. To ensure safe operation, the machine shall be fully enclosed and have an automatic safety clutch or relief valve.
- D. Vacuum machines may be used for removal of materials from manholes when other cleaning equipment is used to dislodge and transport material to the access point.
- E. Combination Cleaner: For cleaning small and large diameter sewer, the Contractor may use a combination hydraulic high volume water and solids separation system. Water volume of up to 250-gpm at or above 2,000-psi will move solids to the downstream manhole in high flow conditions. The separation system will dewater solids to 95 % (passing a paint filter test) and transfer them to a dump truck, if needed, for transport to a water reclamation facility, approved landfill, or other location specified by the County or designee. Wash water will be filtered to a point where it can be used in the pump for continuous cleaning. No bypassing of sewer flows will be necessary. The unit shall be capable of 24-hour operation and the unit shall not leave the manhole until a section is fully cleaned.

1.03 SHOP DRAWINGS AND SUBMITTALS

- A. Submittals shall be submitted to the County for review and acceptance prior to construction in accordance with the General Conditions and specifications Section 01300 "Submittals."
- B. A daily log shall be maintained to record the location of the manholes and sewer lines, lengths of the lines cleaned, method of cleaning, line sizes, identify type of cleaning (light, medium, or heavy), and type of debris moved. Observations are to be recorded on a cleaning report form.

PART 2 - PRODUCTS (NOT USED)

PART 3 - EXECUTION

3.01 GENERAL

- A. All material supplied shall be one of the products specified in Appendix D "List of Approved Products" appended to these technical specifications.
- B. The equipment shall remove dirt, grease, rocks, sand, other materials, and obstructions from the sewer mains, laterals, and manholes.

- C. A high-velocity sewer cleaner will be used for the majority of the cleaning work. Other equipment, such as bucket machines, rod machines, hydraulic root cutters, vacuum trucks and balling equipment shall be available.

3.02 CLEANING PRECAUTIONS

- A. All necessary precautions shall be taken to protect the sewer from damage during all cleaning and preparation operations. Precautions shall also be taken to ensure that no damage is caused to public or private property adjacent to or served by the sewer or its branches. The Contractor shall pay for and restore, at no additional costs to the County, any damage caused to public or private property because of such cleaning and preparation operations.
- B. Satisfactory precautions shall be taken in the use of cleaning equipment. When hydraulically propelled cleaning tools (which depend upon water pressure to provide their cleaning force) or tools which retard the flow in the sewer line are used, precautions shall be taken to ensure that the water pressure created does not damage or cause flooding of public or private property being served by the sewer. No fire hydrant shall be obstructed in case of a fire in the area served by the hydrant. All requirements shall be met when accessing a fire hydrant including but not limited to meters, backflow preventers, and properly trained personnel. It shall be the Contractor's responsibility to meet all state and local requirements.

3.03 CLEANING

- A. If cleaning of an entire sewer section cannot be successfully performed from one manhole, the equipment shall be set up on the other manhole and cleaning attempted again. If results of the cleaning are favorable, the Contractor will proceed with the TV inspection. All sludge, dirt, sand, rocks, and other solid or semisolid materials resulting from the cleaning operation shall be removed from the downstream manhole of the section being cleaned. The Contractor shall not be responsible for removing mortar or other material that is securely attached to the pipe walls or joints.
- B. Materials shall be disposed of from the site at least once at the end of each workday. The Contractor will be responsible for the disposal of materials removed from the sewer system. All sewer-cleaning efforts shall require documentation of all quantities and types of materials removed during cleaning.
- C. The designated sewer manhole sections shall be cleaned using hydraulically propelled, high-velocity jet, or mechanically powered equipment approved by the County. Cleaning shall consist of normal hydraulic jet cleaning to facilitate the internal CCTV inspection.
 - 1. Types of cleaning of sanitary sewers:
 - a. Light cleaning of sewers consists of a maximum of 1 pass of the jet nozzle. Light cleaning of laterals will consist of flushing water into a cleanout.
 - b. Medium cleaning of sewers consists of 2 to 4 passes of the jet nozzle. Medium cleaning of laterals will consist of 1 to 4 passes with a jet nozzle.

- c. Heavy cleaning consists of 5 or more passes of the jet nozzle such as removing heavy grease, debris, and roots.
 - d. Descaling of Ductile Iron pipe: Multiple passes with mechanical equipment to remove scale build up to restore pipe to original inside diameter.
2. Selection of the equipment used shall be based on the conditions of lines at the time the Work commences. The equipment and methods selected shall be satisfactory to the County. The equipment shall be capable of removing dirt, grease, rocks, sand, debris, other materials, and obstructions from the sewer lines, laterals, and manholes.
 3. If cleaning of an entire section cannot be successfully performed from one manhole, the equipment shall be set up on the other manhole and cleaning again attempted. The intent of preparatory cleaning is to provide sufficient cleaning to ensure camera passage and the internal conditions of the pipeline can be fully assessed.
 4. If the County establishes that a particular section of the pipeline cannot be adequately cleaned due to broken, collapsed, or void areas, then the inspection will be attempted up to the obstruction.

3.04 ROOT REMOVAL

- A. Roots shall be removed in the designated sections and manholes where root intrusion is a problem and where authorized by the County. Special attention should be used during the cleaning operation to remove roots from the joints. Any roots that could prevent the proper application of chemical sealants, or could prevent the proper seating and application of cured-in-place liners shall be removed. Procedures may include the use of mechanical equipment such as, rodding machines, bucket machines, winches using root cutters, porcupines, and equipment such as high-velocity jet cleaners. Chemical root treatment shall be used before or following the root removal operation, depending on the manufacturer's recommendation. The Contractor shall capture and remove all roots from the line.

3.05 CHEMICAL ROOT TREATMENT

- A. To aid in the removal of roots, manhole sections that have root intrusion shall be treated with an acceptable herbicide. The application of the herbicide to the roots shall be done in accordance with the manufacturer's recommendations and specifications in such a manner to preclude damage to surrounding vegetation. Any damaged vegetation, so designated by the County, shall be replaced by the Contractor at no additional cost to the County. All safety precautions as recommended by the manufacturer shall be adhered to for handling and application of the herbicide.

3.06 MATERIAL REMOVAL AND DISPOSAL

- A. All sludge, dirt, sand, rocks, grease, roots, and other solid or semisolid material resulting from the cleaning operation shall be removed at the downstream manhole of the section being cleaned. Contractor shall provide appropriate screening to stop passing of materials into downstream sewers. All solid or semisolid materials dislodged during cleaning operations shall be removed from the sewer by Contractor at the downstream manhole of the sewer section being cleaned. The passing of dislodged materials downstream of the sewer segment being cleaned shall not be permitted. In such an event, as observed or detected by the County or any third party, Contractor shall be responsible for cleaning the affected downstream sewers in their entirety, at no additional cost to the County.
- B. These materials shall become the property of the Contractor, shall be removed from the site at the end of each workday, and shall be disposed of by the Contractor. Copies of records of all disposals shall be furnished to the County, indicating disposal site, date, amount, and a brief description of material disposed. Disposal manifests from the licensed disposal facility shall be submitted with invoices.
- C. The Contractor shall keep his haul route and work area(s) neat, clean, and reasonably free of odor, and shall bear all responsibility for the cleanup of any spill.

3.07 ACCEPTANCE OF CLEANING OPERATION

- A. Acceptance of sanitary sewer cleaning shall be made upon the successful completion of the television inspection and shall be to the satisfaction of the County. If television inspection shows the cleaning to be unsatisfactory, the Contractor shall be required to re-clean and re-inspect the sewer line at no additional cost until the cleaning is shown to be satisfactory.
- B. In addition, on all sanitary sewers which have sags or dips, to an extent that the television camera lens becomes submerged during the television inspection, the Contractor shall use a high pressure cleaner to draw the water out of the pipe, or other means, to allow the full circumferential view of the pipe and identification of pipe defects, cracks, holes, and location of service connections.

END OF SECTION

THIS PAGE LEFT BLANK INTENTIONALLY

SECTION 02762
TELEVISIONING SANITARY SEWER SYSTEMS

PART 1 - GENERAL

1.01 SCOPE OF WORK

The Work covered within this Section is for the internal closed circuit television (CCTV) inspection of sanitary sewer pipes. The Contractor shall perform sewer-televising work as necessary to thoroughly document the condition of all sewers, service lateral connections, and manhole corbel, barrel and cone-sections in the study area. The sanitary sewer and service laterals shall be carefully inspected to determine alignment, grade variations, separated joints, location and extent of any deterioration, breaks, obstacles, obstructions, debris, quantities of infiltration/inflow and the locations of service connections.

The quality of all Work specified in this Section shall meet or exceed the requirements of the National Association of Sewer Service Companies (NASSCO) Recommended Specifications for Sewer Collection System Rehabilitation (latest edition), except as described in this Section. Applicable portions of this Section that inadvertently fall below those standards shall be corrected and maintained at the NASSCO standards as a minimum requirement, at no additional cost to the County.

1.02 REQUIREMENTS

- A. The Contractor shall inspect the sewer interior using a color closed circuit television camera (CCTV) and document the inspection on a digital recorder. All inspection video shall be captured in either MPEG or Windows Media Video (.WMV) file format and saved portable hard drives for submittal. Each inspected main line sewer reach, referenced manhole to manhole, and each inspected sewer lateral referenced to the property address and corresponding sewer main should have an associated MPEG or WMV file. Digital photographs (.JPG files), inspection reports (.PDF files) and any handwritten inspection logs or field maps shall accompany the video inspections for each sewer reach (manhole-to-manhole) or lateral inspected.
- B. Contractor shall provide inspection video, data and reports in accordance with the requirements specified herein. Contractor shall provide all video on portable hard drive as specified. All Work will conform to current NASSCO Pipeline Assessment Certification Program (PACP) coding conventions and all software used by the Contractor will be PACP compliant. An electronic database will be provided by the Contractor in a PACP exported format approved by the County.
- C. The Contractor shall provide comments as necessary to fully describe the existing condition of the sewer on the inspection forms.

- D. Contractor shall be responsible for modifications to equipment and/or inspection procedures to achieve report material of acceptable quality.
- E. No Work shall commence prior to approval of the submitted material by the County. Once accepted, the report material shall serve as a standard for the remaining Work.

1.03 QUALITY ASSURANCE

- A. Refer to Section 01101-"Special Requirements (Gravity Inspection Only)" for Contractor's Qualification requirements.
- B. Each CCTV field inspection supervisor shall be NASSCO PACP certified. Use of PACP certified technicians to review/document defects in the office (post process) is not acceptable.
- C. The inspection Contractor must have an internal quality assurance/quality control program in place and all inspection data shall be subjected to the procedures prior to submittal to the County. The County will perform QA/QC audits on submitted data.
- D. QA/QC shall be performed by NASSCO PACP certified personnel.

1.04 SUBMITTALS

- A. Submittals shall be submitted to the County for review and acceptance prior to construction in accordance with the General Conditions and specifications Section 01300 "Submittals."
- B. The following deliverables shall be submitted on a portable hard drive at the completion of inspection:
 - 1. Inspection videos saved in MPEG format or Windows Media video format
 - 2. Electronic version (.pdf) of the pipe inspection reports
 - 3. PACP export pipe inspection database (.mdb)
 - 4. Inspection digital photographs in JPEG format
 - 5. Map of sub area depicting area inspected, inspection status, asset identification numbers and mark ups
 - 6. QA/QC report
- C. The above deliverables shall be submitted monthly to the County for approval. Application for payment shall be made after review and approval by the County.
- D. The sewer inspection video, report documents, and sewer inspection database shall be in accordance with County data standards and NASSCO PACP.

1.05 NOTIFICATION

Contractor shall notify the County a minimum of 48-hours prior to performing any inspection work. No payment will be made for inspections performed without proper notification.

PART 2 - PRODUCTS

2.01 EQUIPMENT

- A. Closed Circuit Television Camera: The television camera used for the inspection shall be one specifically designed and constructed for sanitary sewer inspection. Lighting for the camera shall be suitable to allow a clear picture of the entire periphery of the pipe. The camera shall be operative in 100 % humidity/submerged conditions. The CCTV camera equipment will provide a view of the pipe ahead of the equipment and of features to the side of the equipment through turning and rotation of the lens. The camera shall be capable of tilting at right angles along the axis of the pipe while panning the camera lens through a full circle about the circumference of the pipe. The lights on the camera shall also be capable of panning 90° (degrees) to the axis of the pipe.

The radial view camera must be solid-state color and have remote control of the rotational lens. The camera shall be capable of viewing the complete circumference of the pipe and manhole structure, including the cone-section or corbel. Cameras incorporating mirrors for viewing sides or using exposed rotating heads are not acceptable. The camera lens shall be an auto-iris type with remote controlled manual override.

If the equipment proves to be unsatisfactory, it shall be replaced with adequate equipment. The camera unit shall have sufficient quantities of line and video cable to inspect 2 complete, consecutive sewer reaches with access approximately 750-feet apart.

The camera, television monitor, and other components of the video system shall be capable of producing picture quality to the satisfaction of the County. The television camera, electronic systems and monitor shall provide an image that meets the following specifications, or approved equal:

1. The gray scale shall show equal changes in brightness ranging from black to white with a minimum of five stages.
2. With the monitor control correctly adjusted, the 6-colors; Yellow, Cyan, Green, Magenta, Red, and Blue, plus black and white shall be clearly resolved with the primary colors in order of decreasing luminance. The gray scale shall appear in contrasting shades of gray with no color tint.
3. The picture shall show no convergence or divergence over the whole of the picture. The monitor shall be at least 13-inches diagonally across the picture tube.
4. The live picture on the CCTV monitor shall be capable of registering a minimum of 470 lines horizontal resolution and be a clear, stable image with no interference.
5. Lighting intensity shall be remote controlled and shall be adjusted to minimize reflective glare. Lighting and camera quality shall provide a clear in-focus picture of the entire inside periphery of the sewers and laterals for all conditions except submergence. Under ideal conditions (no fog in the sewer) the camera lighting shall allow a clear picture up to 5 pipe diameter lengths away for the entire periphery of the sewer. The lighting shall provide uniform light free from shadows or hot spots.
6. The camera light head shall include a high-intensity side viewing lighting system to allow illumination of internal sections of lateral sewer connections.

7. Camera focal distance shall be remotely adjustable through a range of 6-inches to infinity.
8. Picture quality and definition shall be to the satisfaction of the County.
9. The monitor and software shall also be able to capture and save screen images of typical sewer details and all defects. Screen images shall be embedded into the pipe inspection report document submitted with the inspection video.
10. The video camera shall be capable of displaying on screen data as specified in paragraph 3.08 herein.
11. Depth gage: The camera shall have a depth gage or approved method to measure deflection in the pipe and joint separation approved by the County.
12. The camera shall have zoom capabilities to be able to view the entire depth of a 20-foot deep manhole from the bottom during inspection.

B. Lateral Video Camera

Lateral cameras may be push type or launched from the sewer main line. Lateral cameras shall be color, shall be self-leveling, and equipped with a footage counter to provide on-screen display of footage measurement. Monitor resolution shall be as specified above in paragraph 2.01 A Close Circuit Television Camera, or approved equal

C. Video Capture System

The video and audio recordings of the sewer inspections shall be made using digital video equipment. A video enhancer may be used in conjunction with, but not in lieu of, the required equipment. The digital recording equipment shall capture sewer inspection on DVD disks or hard drive, with each sewer reach inspection recorded as an individual movie file (.MPEG, .MPG, or .WMV) or approved equal. The video files will be named in accordance with the County file naming convention contained in paragraph 3.11 herein.

1. The video file names will be referenced in the inspection database and in an inspection report generated in PDF format. The pipeline collection and real time video capture and data acquisition systems shall be provided.
2. The system shall use the most current PACP compliant application software and shall be fully object oriented or approved equal. It shall be capable of printing pipeline inspection reports with captured images of defects or other related significant visual information on a standard color printer.
3. The imaging capture system shall store digitized color picture images and be saved in digital format on a DVD, hard drive or approved equal. Also, this system shall have the capability to supply the County with inspection data reports for each line segment.
4. The Contractor shall have the ability to store the compressed video files in industry standard and approved County format and be transferable with the PACP compliant inspection database.
5. The Contractor's equipment shall have the ability to "Link". "Linking" is defined as storing the video time frame code with each observation or defect with the ability to navigate from/to any previously recorded observation or defect instantaneously.
6. The system shall be able to produce data reports to include, at a minimum, all observation points and pertinent data. All data reports shall match the defect severity codes in accordance with PACP naming conventions

7. The data-sorting program shall be capable of sorting all data stored using generic sort key and user defined sort fields.
8. Camera footage, date & manhole numbers shall be maintained in real time and shall be displayed on the video monitor as well as the video character generators illuminated footage display at the control console.
9. Digital video shall be defined as ISO-MPEG Level 1 (MPEG-1) coding having a resolution of 352 pixels (x) by 240 pixels (y) (minimum) and an encoded frame rate of 29.97 frames per second. The digital recording shall include both audio and video information that accurately reproduces the original picture and sound of the video inspection. The video portion of the digital recording shall be free of electrical interference and shall produce a clear and stable image. The audio portion shall be sufficiently free of background and electrical noise so as to produce an oral report that is clear and discernible.
10. Inspection software shall be PACP compliant versions of CUES Granite XP, WinCan, Flexidata, or approved equal.
11. The CCTV equipment/software shall be capable of producing digitized images of all sewer line defects, manhole defects, and sewer line service connections in .jpeg format. Contractor shall plan to take digital still images of each defect, construction features and service connection to clearly depict it. More images may be necessary depending upon the condition of the pipe.

2.02 REPORTING CAPABILITIES

- A. The CCTV system shall be capable of printing pipeline inspection reports with pipeline schematics and captured images of defects and other related significant visual information. The system shall have the ability to display any combination of the following formats and features simultaneously.

The following information is mandatory for all inspections:

1. Inspection Information: Refers to the area of pipe to be inspected between 2 manholes or the address of the lateral to be inspected.
 - a. Project Name
 - b. Surveyed by (Operator/Surveyor's name)
 - c. Operator/Surveyor Certificate number
 - d. System Owner
 - e. Date
 - f. Drainage Area (tributary pump station number)
 - g. Time
 - h. Sheet number (report sheet number)
 - i. Street Name and Number
 - j. Locality (Orange County)
 - k. Additional Location Information (e.g. backyard, parking lot, etc)
 - l. Upstream Manhole Number (County standard Asset Number)
 - m. Upstream MH rim to invert (depth)
 - n. Downstream Manhole Number (County standard Asset Number)
 - o. Downstream MH rim to invert (depth)
 - p. Direction of inspection (Upstream or Downstream)

- q. DVD Identification Number
 - r. Flow control (e.g. plugged, lift station, bypassed, not controlled)
 - s. Type of Pipe
 - t. Pipe Height
 - u. Pipe Width
 - v. Pipe Shape
 - w. Pipe Material
 - x. Lining Material (for lined sewers)
 - y. Pipe Joint Length
 - z. Purpose of Inspection (new line, year-end warranty, CIP R/R project, etc.)
 - aa. Pre Cleaning (jetter, heavy cleaning, no pre-cleaning)
 - bb. Media Number (Video file name)
 - cc. Weather
 - dd. Additional information/Comments
2. Observation Data: Refers to the portion of pipe where an observation is discovered. Observations shall be noted by text descriptions and defect code number using PACP defects codes, still frame pictures and video clips captured and recorded. Each observation shall include the following:
 - a. Actual observation footage
 - b. Video reference
 - c. Location of defect; clock position
 - d. Code (Group/Descriptor/Modifier/Severity)
 - e. Whether it is a continuous defect
 - f. Whether the defect occurs at a joint
 - g. Severity level
 - h. DVD Identification number
 - i. DVD counter
 - j. Final footage
 - k. Video clip ID for each observation
 - l. Image reference (file name of photos)
 - m. Remarks (as appropriate or needed)
 3. Formats: Standard and/or custom designed reports shall have the following formats available and shall be able to be produced in hard copy or viewed on the monitor.
 - a. Site Observation: Displays detailed site observation reports in landscape or portrait views.
 - b. Directory Report: Displays a list of all the projects sorted by pump station number and manhole number.
 - c. Picture Reports: Displays site data and include full size single photos or half size double photos of discrepancies.
 - d. Pipe Run: Displays a graphical display of the site indicating footage, observations, and comments.
 - e. Project Data: Displays the project, client, and Contractor information.
 - f. Custom Sort: Creates user-defined reports of selected site, project, and observation data.

PART 3 - EXECUTION

3.01 GENERAL

- A. Prior to inspection the Contractor shall obtain pipe and manhole asset identification numbers from the County to be used during inspections. Inspections performed using identification numbers other than the County assigned numbers will be rejected.
- B. Inspection shall not commence until the sewer section to be televised has been completely cleaned in conformance with Specification Section 02761 "Cleaning Sanitary Sewer Systems."
- C. Inspection of newly installed sewers (not yet in service) shall not begin prior to completion of the following:
 - 1. Pipe air testing
 - 2. All manhole work, including installation of inverts
 - 3. Installation of all lateral services
 - 4. Vacuum tests of all manholes
- D. After the sewer main and/or lateral cleaning operation is completed, the line sections shall be visually inspected internally by means of color closed-circuit television. The television inspection shall be performed one line section at time.
- E. CCTV inspection shall require a minimum of 2 certified personnel with PACP certifications.
 - 1. One (1) person shall have PACP certification that will lead or supervise each field CCTV crew for inspection and a minimum of 2-years in the role of a lead person.
 - 2. One (1) person shall have PACP certification serving in the role as a QA/QC management supervisor
- F. Contractor shall perform sewer-televising work within 24-hours of said sewer being cleaned. If said sewer is not televised within the required 24-hour time limit, the sewer shall be re-cleaned prior to televising at no additional expense to the County.
- G. The Contractor shall also inspect and document all manholes included in this Work. The video recording shall begin as the camera is lowered down the manhole all the way to the preset footage and continuously throughout the pipe reach until the down stream manhole is reached.
- H. The Contractor shall lower the camera into the start manhole and record the camera entry into the sewer, observing the manhole as the camera enters.
- I. The camera shall pan the periphery of the start and finish manhole from casting to invert. To achieve this, the CCTV camera operator shall pan and zoom the manhole to obtain the best possible image of the manhole, including the wall, cone and chimney section(s).
- J. The depth of each manhole shall be measured to the nearest 1/10th of a foot and documented on the inspection forms. Estimates of manhole depths will not be accepted.

- K. The CCTV camera shall be positioned as close to the spring line as possible while maintaining the required equipment stability.
- L. Wherever possible the inspections shall be performed in the upstream to downstream direction. All sewer segments shall be recorded in a logical order in the same direction they are cleaned and televised.
- M. In the event that access to some manholes is restricted, permission may be granted by the County to direct the camera through the sewer in an upstream direction, against the flow.
- N. When sewer conditions prevent forward movement of the camera, the camera shall be withdrawn, and Contractor shall televise the line from the opposite direction.
- O. The camera shall be directed through the sewer in a downstream direction, with the flow, at a uniform, slow rate. In no case will the video camera record while moving at a speed greater than 30-feet per minute. If, during the course of the Project, the inspection is rejected due to camera speeds exceeding 30-feet per minute, the inspection recordings shall be redone, at no additional cost to the County.
- P. If a new manhole is discovered in the field that was not on current maps, a new manhole identification number will be assigned by County. The County shall assign the manhole the next number above the highest manhole number within the sub area. The data / video files shall then be re-named to include the new MH ID, and a new CCTV inspection shall be started from the new MH ID. Contractor shall consult with the County for assignment of new manhole identification numbers. Contractor shall note in the inspection form comments that a new manhole ID has been assigned as well as provide a marked up map indicating the newly found manhole and assigned manhole ID.
- Q. Flow levels within existing sewers to be inspected shall not exceed 5% of the pipe diameter. If water levels prevent adequate televising of the sewer, then conducting the Work during low flow periods or other methods like plugging and bypass pumping shall be implemented.
- R. For inspection of new sewers (not yet in service), the Contractor shall introduce clean water into the upstream manhole and keep water flowing until flow is observed at the downstream manhole location.
- S. The survey unit shall be slowed, stopped, or backed up to perform detailed inspections of significant features. The camera shall be stopped at all defects, changes in material, water level, size, side connections, manholes, junctions, or other unusual areas. When stopped at the defect or feature, the operator shall pan the camera to the area and along the circumference of the pipe.
- T. The camera unit shall be paused long enough at areas suspected of leaking to determine if a leak exists currently or if deposits have occurred.
- U. The operator shall also record audio of the type of defect or feature, clock position, footage, extent or other pertinent data.

- V. Digital photographs or screen captures shall be taken at all laterals; defects and general condition photographs shall be taken at least every 200-feet.
 - W. At the Contractor's discretion or direction of the County, the camera shall be stopped or backed up (when conditions allow) to view and analyze conditions that appear to be unusual or uncommon for a sound sewer. The lens and lighting shall be readjusted, if need be, in order to ensure a clear, distinct, and properly lighted feature.
 - X. Audio shall be recorded during each inspection by the operating technician, electronic voice text recognition or approved equal on the inspection video as the sewer is inspected and shall include the sewer location, identification of beginning and terminating manholes including location (address or cross streets), inspection direction, length of inspection, side sewer identification, flow information, complete descriptions of the sewer line conditions as they are encountered, description of the rehabilitation work, reason for termination, and other relevant commentary to the inspections. Voice descriptions should be made:
 - 1. At points of pipe failure or weakness
 - 2. At points of infiltration
 - 3. At the location of service connections
 - 4. At points where unusual conditions are noted, and
 - 5. At points where digital still photos are taken.
- In addition, the audio reports shall include the distance traveled on the specific run, a description of abnormal conditions in the sewer and side sewer connections as they are encountered, explanations for pausing, backing up, or stopping the survey, and the final measured center to center distances between consecutive manholes. The audio portion of the composite video shall be sufficiently free from electrical interference and background noise to provide complete intelligibility of the oral report. Audio dubbing after the inspection is prohibited.
- Y. Video recordings shall include a continuous video display/readout of similar information, as described in paragraph 3.08 herein. A separate digital video file shall be made for each pipe reach inspected.
 - Z. Contractor shall coordinate with the County prior to commencement of Work to ensure inspection is accomplished in a manner acceptable to the County.
 - AA. If the video and/or audio recording is of poor quality, the County has the right to require a re-submittal of the affected sewer sections and no payment will be made until an acceptable video and audio recording is made, submitted to, and accepted by the County.
 - BB. Measurement for location of defects and actual length of pipe shall be by means of a calibrated meter on the camera with a digital readout on the video monitor. This readout shall be included in the video recording. Marking on cable, or the like, which would require interpolation for depth of manhole, will not be allowed. Measurement will be accurate to 1-foot per 100-feet of inspected pipe.

- CC. The Contractor inspection units shall be equipped with adequate back up equipment and spare parts so field repairs to equipment can be made and down time is minimized.
- DD. The Contractor shall be responsible for all traffic control measures required to perform the Work.
- EE. Lateral inspections shall be performed from the main line using a lateral launch camera or shall be pushed from cleanouts to the sewer main using sewer rods. Lateral camera travel measurements shall be displayed on screen and on the captured video.
- FF. If lateral inspections are performed from the sewer main as part of the main line inspection, the lateral shall be logged in the main line inspection report per PACP requirements and the "comment" field of the main line inspection report shall be used to document the lateral identification number, defects observed, footage of all lateral defects, connecting pipes and clean outs. If lateral inspections are not performed as part of the main sewer inspection, a separate PACP pipe inspection record shall be created for each lateral. Refer to paragraph 3.10 for numbering requirements.

3.02 PRE-CONSTRUCTION INSPECTION

A. Procedure

1. Prior to any repair work, the entire sewer line (from manhole to manhole) shall be televised. The pre-construction inspection shall be used to determine whether the line has been cleaned sufficiently; to confirm the location and nature of defects; and to confirm that the proposed method of repair is proper method for the defects observed.
2. The camera shall be moved through the line in either direction at a moderate rate, stopping when necessary to permit documentation of the sewer's condition. In no case will the television camera be pulled at a speed greater than 30-feet per minute. Manual winches, power winches, TV cable, and power rewinds or other devices that do not obstruct the camera view or interfere with proper documentation of the sewer conditions shall be used to move the camera through the sewer line. If, during the inspection operation, the television camera will not pass through the entire manhole section, the Contractor shall set up his equipment so that the inspection can be performed from the opposite manhole (reverse set-up).
3. When manually operated winches are used to pull the television camera through the line, telephones, radios or other suitable means of communication shall be set up between the 2 manholes of the section being inspected to insure good communication between members of the crew.
4. The importance of accurate distance measurements is emphasized. The location of defects shall be within ± 2 feet.
5. During the internal inspection the television camera shall be temporarily stopped at each defect along the line. The Contractor shall record the nature and location of the defect. Where defects are also active infiltration sources, the rate of infiltration in gallons per minute shall be estimated by the Contractor and recorded. The camera shall also be stopped at active service connections where flow is discharging. Flows from service connections that are determined to be infiltration/inflow shall also be recorded.

B. Documentation of Television Inspection

1. Television Inspection Logs: Printed location records shall be kept by the Contractor and will clearly show the location in relation to an adjacent manhole of each infiltration point observed during inspection. In addition, other points of significance such as locations of building sewers, unusual conditions, roots, storm sewer connections, broken pipe, presence of scale and corrosion, and other discernible features will be recorded and a copy of such records will be supplied to the County. The Contractor shall record all visual observations on a "Television Inspection Report" form.
2. Once recorded, the digital data shall be labeled and become the property of the County. The Contractor shall have all readings and necessary playback equipment readily accessible for review by the County during the Project.

3.03 POST CONSTRUCTION INSPECTION

A. Procedure

1. After the sewer line rehabilitation has been completed, the entire sewer line from manhole to manhole shall be televised. The post construction inspection shall be used to determine whether or not all of the approved sewer line defects and infiltration sources previously located have been fully repaired to the satisfaction of the County.
2. The camera shall be moved through the line in either direction at a moderate rate, stopping when necessary to permit documentation of the sewer's condition. In no case will the television camera be pulled at a speed greater than 30-feet per minute. Manual winches, power winches, TV cable, power rewinds or other devices that do not obstruct the camera view or interfere with proper documentation of the sewer conditions shall be used to move the camera through the sewer line. If, during the inspection operation, the television camera will not pass through the entire manhole section, the Contractor shall set up his equipment so that the inspection can be performed from the opposite manhole or direction.(reverse-setup)
3. When manually operated winches are used to pull the television camera through the line, telephones, radios or other suitable means of communication shall be set up between the 2 manholes of the section being inspected to insure good communication between members of the crew.
4. The importance of accurate distance measurements is emphasized. The location of defects shall be within 1-foot.
5. During the internal inspection the television camera shall be temporarily stopped at each repair. The camera shall also be stopped at any unnoticed or non-repaired point source of infiltration.

3.04 SEWER BYPASSING AND DEWATERING

Contractor shall be responsible for bypassing sewer flow around his work and dewatering of sewer lines in accordance with the requirements of Section 01516 "Collection System Bypass". Where sags or submerged sections of the sewer are encountered during TV inspection, the Contractor shall first complete inspection of the entire reach to determine the extent of such areas prior to dewatering the sewer. Dewatered sections of the sewer shall then be TV inspected.

On all sewer mains which have sags or dips, to an extent that the television camera lens becomes submerged during the television inspection, the Contractor shall use a high pressure cleaner to draw the water out of the pipe, or other means, to allow inspection of the pipe and identification of pipe defects, cracks, holes and location of service connections.

3.05 LINEAR MEASUREMENT

The CCTV camera location footage counter shall be zeroed at the beginning of each inspection. The survey unit location entered on the footage counter at the start of the inspection shall allow for the distance from the accepted start of the length of the sewer to the initial point of observation of the camera (pre-set footage). In the case of resuming an inspection at an intermediate point within a sewer reach, the footage counter shall be set to start at the distance from the upstream maintenance hole to that point, as previously recorded by the counter. The Contractor shall ensure that the footage counter starts to register immediately when the survey unit starts to move.

The lateral camera shall be pushed from cleanouts to the sewer main and be equipped with a footage counter to display and record inspection footage. Maximum rate of travel shall be 30-feet per minute when recording.

Prior to commencing inspections, the Contractor shall demonstrate compliance with the linear measurement tolerance specified below:

- A. The equipment shall measure the location of the camera unit in 1-foot increments from the beginning (upstream end) of each continuous section. This footage location must be displayed on the CCTV monitor and recorded on the videotapes.
- B. The accuracy of the measured location shall be within + 0.5% of the actual length of the sewer-reach being surveyed, or 1-foot, whichever is greater.

3.06 MEASUREMENT OF SAGS

The CCTV camera shall be equipped with a measuring device capable of accurately measuring the depth of standing water up to 3-inches. The measuring device shall be mounted to the front of the unit and be capable of being read as the unit advances through the pipe.

3.07 CCTV MONITOR DISPLAY

The images displayed on the CCTV monitors will be a view of the pipe above the water surface as seen by the CCTV camera as the unit is conveyed through the sewer.

The camera lighting shall be fixed in intensity prior to commencing the survey and the white balance set to the color temperature emitted. In order to ensure color constancy, no variation in illumination shall take place during the survey.

The video equipment shall be checked using an approved test card with a color bar prior to commencing each day's survey. The camera shall be positioned centrally and parallel to the test card at a distance where the full test card just fills the monitor screen. The card shall be illuminated evenly and uniformly without any reflection.

3.08 DATA DISPLAYS

- A. The CCTV images shall include an initial data display that identifies the sewer reach being surveyed and a survey status display that provides continuously updated information on the location of the survey unit as the survey is being performed. These data displays shall be in alphanumeric form. The size and position of the data shall not interfere with the main subject of the monitor picture.
- B. The on-screen display should be white during inspections where the background behind the display is dark and, conversely, black where the background is light.
- C. At the beginning of each reach of sewer being inspected, the following information shall be electronically generated and displayed on the CCTV monitors as well as included in the audio track:
 - 1. Date of survey
 - 2. Inspection company name and inspector
 - 3. Street name or location
 - 4. Manhole number to manhole number (in order of inspection)
 - 5. Direction of survey (upstream or downstream)
 - 6. Time of start of survey
- D. During inspections, the following information shall be electronically generated, automatically updated, and displayed on the CCTV monitors:
 - 1. Survey unit location in the sewer line in feet and tenths of feet from adjusted zero
 - 2. Sewer diameter
 - 3. Upstream and downstream manholes reference numbers as per approved Drawings or County GIS.
 - 4. During Lateral inspections the video display shall contain the lateral location and the footage of the camera within the lateral.

3.09 PHOTOGRAPHS

During CCTV inspections, screen captures will be taken from the monitor images and saved electronically by the in-sewer inspection crew of typical conditions every 200-feet and at all defects, construction features, manholes and laterals. The screen capture shall have the pipe reach (identified by the upstream and downstream manholes), survey direction, footage, and date when photograph was taken. The annotation shall be clearly visible and in contrast to its background, shall have a figure size no greater than 1/4-inch, and shall be type-printed. The annotation shall be positioned on the front of the photograph so as to not interfere with the subject of the photograph. Photograph files shall be named by the video capture system and automatically referenced to the logged defect.

The image of the sewer shall fill the photographic image. Photographs must clearly and accurately show what is displayed on the monitor, which shall be in proper adjustment. Where significant features exist within 6-feet of each other, 1 photograph shall be made to record these features. Where there is a continuous feature, photographs shall not be taken at intervals of less than 6-feet unless absolutely necessary to show a change in the feature.

The images shall be kept electronically, copied to a hard drive, and submitted with the inspection videos, database and reports.

3.10 MANHOLE NUMBERING, INSPECTION FORMS AND DEFECT CODES

- A. The Contractor will be required to use the manhole numbering as shown on sewer maps provided by the County when performing the inspections for this project.
- B. The County inspection forms and standard defect codes shall be used. The defect codes, inspection forms, inspection database and inspection protocols shall be in accordance with the National Association of Sewer Service Companies (NASSCO) Pipeline Assessment and Certification Program (PACP).
- C. When lateral inspections are performed as part of the main sewer inspection, lateral numbers shall be referenced in the "comment" field of the main sewer PACP report. The lateral number shall be as follows:

<Upstream Manhole ID>_<footage>_<clock position>_<L>

Example: 39550020_212_02_L

- D. When lateral inspections are not performed as part of the main sewer inspection, the main sewer inspection shall be performed first to obtain the footage and clock positions needed to identify the lateral.

3.11 DELIVERABLES

The Contractor will be required to submit the following deliverables at the completion of the post construction video inspection. The pre-construction video inspection deliverables shall be as defined in 3.02 of this specification.

- A. Inspection Reports to include:
 - 1. Inspection session header information (see required fields above)
 - 2. Defect log report including photo captures from CCTV video
 - 3. Schematic drawing of pipe showing defects
 - 4. Format:
 - a. Adobe Acrobat PDF files: 1 report PDF per pipe
 - b. Main sewer inspection report file name:

<upstream MH ID>_<downstream MH ID>_<Date (year_mo_day format)>.PDF

Example: 30060002_30060001_2010_02_16.pdf

c. Lateral inspection report file name:

<upstream MH ID>_<footage>_<clock position>_<L>_<Date (year_mo_day format)>.PDF_

Example: 30060002_210_02_L_2010_02_16.pdf

B. Inspection video files on portable hard drive, typed labels shall be attached to the face of each hard drive. The typed index labels shall include the following information:

1. Content (CCTV)
2. Contractor name
3. Purpose of Survey
4. Tributary Pump station number
5. Reaches included (from Manhole Number ## to Manhole Number ##)
6. Date of survey
7. Contract Number / Delivery Order Number (if applicable)

C. Main sewer video files shall be MPEG or Windows Media File named according to the following standard:

<Upstream MH ID>_<Downstream MH ID>-<Inspection>_<Date (year month day)>.wmv

Example: 39540008-39540007_20090805.wmv

In instances where a reverse set up is necessary to perform or complete the inspection the file name shall incorporate a "R" at the end of the file name to indicate "reverse" direction. Using the file example above, if the inspection from the upstream end was halted due to an obstruction and the pipe was televised from the opposite end, the video file from the downstream to upstream direction would be assigned the following file name:

Example:39540008-39540007_20090805_R.wmv

D. Lateral connection inspection video files shall be MPEG or Windows Media File named according to the following standard:

<Upstream MH ID>_<footage>_<clock position>_<L>_<date (year_mo_day format)>.wmv

Example: 39540008_145_10_L_2009_08_05.wmv

E. Electronic Inspection Data stored and exported in a NASSCO Pipeline Assessment and Certification Program (PACP) compliant Microsoft Access database (.MDB) version 4.4 or newer delivered on DVD or portable hard drive.

F. Inspection photograph digital files (jpeg) indexed to NASSCO PACP compliant database.

G. Map of sub area depicting area inspected, inspection status, asset identification numbers and mark ups,

H. Acceptable media for the video recordings portable hard drive.

- I. Inspection data noted above shall be provided to the County weekly throughout the inspection work.
- J. Contractor Quality Control report detailing data validation performed, pipe inspection records reviewed and results.
- K. All inspection data shall be submitted on a portable hard drive. Each hard drive shall be filled with as much data as practical to minimize the number of hard drives submitted. Sections of a single segment of sewer main shall not be recorded to more than 1 hard drive. Video footage of recorded segments shall be grouped by area and shall be submitted in sequential order relating to the area mapping designation.
- L. Upon approval by the County of all, or portions of, the data delivered via the portable hard drives, the approved CCTV data shall be delivered to the County on a portable hard drive labeled with project information. The hard drive shall clearly indicate the date of the inspection, the designated segment(s) of sewer mains(s) contained on the disk, the name of the project, the project CIP number, the pump station number, and Contractor name. The hard drive shall contain separate digital files for each manhole-to-manhole section.
- M. The database shall be comprehensive for the entire project, and additional data shall be added to the database each week.

3.12 ACCEPTANCE

- A. Inspection deliverables will be validated to check conformance with the specified requirements for file names, formats, quantity, resolution, data table references, in addition to checks for null fields, asset numbers, duplicate records, connectivity, material, size, and depth. Any data not passing the data validation checks will be returned to the Contractor for resubmittal.
- B. Inspection submittals will be reviewed for quality control. A minimum of 5% of the submitted inspections will be randomly reviewed. A quality control check will be performed for each CCTV operator and each operator must exceed 90% accuracy. Reference Section 01101 "Special Requirements (Gravity Inspection Only)."
- C. Throughout the duration of the project, should the County discover inaccuracies in data or quality issues with any of the videos, Contractor shall re-inspect those segments at no additional cost to the County. The County will provide comments regarding acceptance of the data within 21-days of receiving the data from the Contractor. Neither the CCTV inspections nor the WORK inspected is accepted by the County until such time that an acceptance letter is issued by the County.

END OF SECTION

SECTION 02771
CURE-IN-PLACE PIPE FOR SANITARY SEWER RENEWAL

PART 1 - GENERAL

1.01 REQUIREMENTS

- A. The Work within this Section consists of the installation and testing cured-in-place pipe (CIPP) lining by installation of a resin impregnated flexible felt tube into the existing sanitary sewer pipe utilizing a vertical inversion standpipe and hydrostatic head, pulled in place, or other approved method and curing by circulating hot water or other approved means to produce a hard, impermeable pipe.
- B. The finished liner shall extend over the installation length in a continuous, tight fitting, watertight pipe-within-a-pipe and shall be fabricated from materials which, when installed, will be chemically resistant to withstand internal exposure to domestic sewage. The Contractor shall confirm through field measurements the actual length, diameter and depth of the sewer pipe to be rehabilitated prior to fabricating the liner.

1.02 INSTALLER EXPERIENCE AND QUALIFICATIONS

- A. The installer must have sufficient experience in the commercial installation of the liner and must have installed a minimum of 50,000 lineal feet. The inability to document such experience may be grounds for rejecting the proposed installer.
 - 1. Superintendent's resume of projects. Each reference project shall include the pipe dimensions, length of installation, size/type of flow control required to perform the Work, description of the actual work performed including installation method, owner's name, telephone number and contact person, date of installation. The Contractor shall submit the name(s) and qualifications for each scheduled superintendent for this project. It is required that the Superintendent(s) named are the Superintendent(s) assigned to this project and on site during construction. The Contractor is required to have at least 1 qualified Superintendent on site at all times during the construction activities. All referenced experience shall be for projects completed within the United States or Canada and shall have used the same installation method, CIPP liner and resin combination proposed for this project. References will be checked.
 - 2. The proposed Superintendent must have a minimum of 3-years of CIPP lining supervisory field experience on projects totaling a minimum of 50,000 LF of 8-inch or greater CIPP liner installation using the methods and materials proposed for this Work, as documented by verifiable references.

3. Installation Crew: At least 1 person other than the Superintendent from the CIPP installation crew shall have a minimum of 1-year of CIPP experience totaling at least 20,000 lineal feet of 8-inch or greater installed liner. The crewmember with listed qualifications must be on the project site during all installation activities.
4. Boiler Technician: Contractor shall provide the name and information for the boiler technician who will perform the actual Work. The boiler technician must have a minimum of 2 projects totaling at least 10,000 lineal feet of CIPP lining in which a similar position was held.
5. Lateral Cutter Technician: Contractor shall provide the name and information for the technician who will perform the actual Work. The lateral cutter technician must have a minimum of 2 projects totaling at least 10,000 lineal feet of CIPP lining in which a similar position was held.
6. The final decision to accept or reject the product, manufacturer, and/or installer lies solely with the County. The named Manufacturer, Field Superintendent, CIPP Installer, Lateral Cutter, and Boiler Technician must be employed to perform the Work, unless changes are specifically authorized by the County.

1.03 REFERENCES

A. Codes, Specifications, and Standards

1. Codes, specifications, and standards referred to by number or title shall form a part of this specification to the extent required by the references thereto. Latest revisions shall apply, unless otherwise shown or specified.
2. All pipe materials incorporated in the project shall be approved by the Florida Environmental Protection Division for the application to be used, prior to receipt of bids.
3. American Society for Testing and Materials (ASTM) Standards
 - a. D 638 - Test Method for Tensile Properties of Plastics
 - b. D 790 - Test Methods for Flexural Properties of Un-reinforced and Reinforced Plastics and Electrical Insulating Materials
 - c. D 1222 - Determining Dimensions of Thermoplastic Pipe and Fittings
 - d. D 2837 - Obtaining Hydrostatic Design Basis for Thermoplastic Pipe Materials
 - e. F 1216-98 - Rehabilitation of Existing Pipelines and Conduits by Inversion and Curing of a Resin-impregnated Tube
 - f. F 1743-96 - Rehabilitation of existing pipelines and conduits by pulled-in-place installation of cured-in-place thermo setting resin pipe

1.04 RESPONSIBILITY FOR OVERFLOWS AND SPILLS

- A. It shall be the responsibility of the Contractor to schedule and perform his work so as to result in no overflows or spills of sewage or combined sewage from the system. If sewage flows are such that they interfere with the Contractor's ability to perform work, the Contractor shall be responsible for scheduling his work during low flow periods or provide bypass pumping. Bypass pumping shall be provided only with the specific written approval of the County.

- B. In the event of overflows caused by the Contractor's work activities, the Contractor shall immediately take appropriate action to contain and stop the overflow, clean up the spillage, disinfect the area affected by the spill, and notify the County in a timely manner.
- C. Contractor will indemnify and hold harmless the County for any fines or third-party claims for personal or property damage arising out of a spill or overflow that is fully or partially the responsibility of the Contractor. Should fines subsequently be imposed as a result of any overflow for which the Contractor is fully or partially responsible, the Contractor shall pay all such fines and all of the County's legal, engineering, and administrative costs in defending such fines and claims associated with the overflow.

1.05 SHOP DRAWINGS AND SUBMITTALS

- A. Submittals shall be submitted to the County for review and acceptance prior to construction in accordance with the General Conditions and specifications Section 01300 "Submittals."
- B. Submit the following:
 - 1. The Qualifications of the installer shall be submitted 1-week prior to Pre-Construction conference.
 - a. Name: business address and telephone number of the Contractor
 - b. Name(s) of personnel and experience for Field Superintendent, CIPP Installer, Lateral Cutter, and Boiler Technician to be directly involved with this project
 - c. The Contractor shall sign and date the information provided and certify that to the extent of his knowledge, the information is true and accurate, and that the supervisory personnel will be directly involved with and used on this project. Substitutions of personnel and/or methods will not be allowed without written authorization of the County.
 - d. Specialty technicians shall be certified by the equipment manufacturer and/or its authorized representative. Certifications shall be submitted to the County/Professional.
 - e. The Contractor shall provide his references of previous project lists going back 3-years including his customer's names, owner's contact name, phone number, owner's project number, owner's project name and the list must include the linear feet of liner installed.
 - 2. Manufacturer's Certificate of Compliance certifying compliance with the applicable specifications and standards, a minimum of 500,000 linear feet of liner installed in U.S.
 - 3. The Manufacturer shall warrant the liner to be free from defects in materials and installation for an extended 5-years from the date of Final Acceptance.
 - 4. Certified copies of test reports of factory tests required by the applicable standards and this Section.
 - 5. Manufacturer's installation instructions and procedures.
 - 6. Contractor's procedures and materials for service renewal including time and duration of sewer service unavailability.

7. Data, measurements, assumptions and calculations for sizing liners, signed and sealed by a Professional Engineer registered in the state of Florida and certified by the manufacturer as to the compliance of his materials to the values used in the calculations.
 8. Sampling procedures and locations for obtaining representative samples of the finished liner.
 9. List of primary and backup equipment to be utilized on the job.
 10. Contractor shall submit manufacturer's detailed procedures for repairing liners that have been installed incorrectly or that have failed during installation.
 11. The Contractor shall submit a wastewater pre-treatment plan including data, measurements, assumptions, calculations and procedures for the pre-treatment of CIPP process wastewater containing regulated chemicals.
- C. A final certificate of compliance with this specification shall be provided by the manufacturer for all lining material furnished. Tests for compliance by an independent laboratory shall be made according to the applicable ASTM specification and the manufacturer's quality control program.
- D. As part of the design calculation submittal, the liner manufacturer shall submit a tabulation of time versus temperature. This tabulation shall show the lengths of time that exposed portions of the liner will endure without self-initiated cure or other deterioration beginning. This tabulation shall be at 5°F (degrees Fahrenheit) increments ranging from 70°F to 100°F. The manufacturer shall also submit his analysis of the progressive effects of such "pre-cure" on the insertion and cured properties of the liner. This information shall be submitted in a timely fashion prior to construction. The minimum liner thickness is for materials with characteristics as shown. Bidders with materials with other characteristics must supply complete information in their bids of the values as listed for ascertaining minimum thickness.
- E. Approval of Products
1. A product will be considered for approval if a minimum of 500,000 lineal feet of the proposed pipe liner has been installed in sewer collection pipes in the United States. An acceptable third party testing facility shall perform all tests. These tests shall be based on the following standards:
 - a. Materials tested shall be identical to those proposed for installation from samples of materials in final resting place after the trauma of installation and/or reforming of the product. Testing shall be in accordance with applicable ASTM standards. Laboratory samples will not be acceptable.
 - b. Short-term tests can be extrapolated using actual short-term test data and applicable ASTM standards for plastic pipe.
 - c. An independent third party qualified in these testing procedures shall validate all test data (whether theoretically extrapolated or actual).
 - d. The manufacturer shall submit all ASTM standards for installation and/or materials on their product. Foreign standards will not be accepted.

- e. Manufacturer shall submit an engineering design guide and quality control procedures for product manufacturer and for product installation, including detailed inspection, testing of physical properties, retention of product samples, taking of and testing of field samples.
- f. Manufacturer shall submit statements as to country of manufacturer of all major components used to produce the final installed product.
- g. Manufacturer and installer shall submit evidence of installer training, testing and/or certification of being trained to install the product by the manufacturer.
- h. Manufacturer shall provide detailed installation procedures, detailed procedures for reconstruction of existing laterals and for new service connections. This shall include an itemized list of the tasks to be performed and the estimated times for each task. Manufacturer shall include the estimated number of excavations, if any, required for each line segment to be installed.
- i. Manufacturer shall submit detailed procedures of repairing its own product in the event of failure.
- j. In the event change in the product (material) occurred within the past 3-years, the manufacturer shall disclose in writing, the date each change occurred, what change occurred, the reason for the change, the number of lineal feet installed within each change period, the last date since a change occurred, and the number of lineal feet installed since the last change. The County reserves the right to require additional detailed information on the product (material) in the event changes have occurred.

1.06 DELIVERY, STORAGE, AND HANDLING

- A. The Contractor shall be responsible for the delivery, storage, and handling of products. No products shall be shipped to the job site without the approval of the County.
- B. Keep products safe from damage. Promptly remove damaged products from the job site. Replace damaged products with undamaged products.

1.07 LINE OBSTRUCTIONS

- A. It shall be the responsibility of the Contractor to clear the line of obstructions such as solids and roots that will prevent the insertion of CIPP. If pre-installation inspection reveals an obstruction such as protruding service connection, dropped joint, or a collapse that will prevent the inversion process, that was not evident on the video and it cannot be removed by conventional sewer cleaning equipment, the County will be notified immediately.

PART 2 - PRODUCTS

2.01 GENERAL

- A. All material supplied shall be one of the products specified in Appendix D "List of Approved Products" appended to these technical specifications.

- B. Pipe lining products pre-approved by the County include: Insituform (CIPP Liner), National Liner (CIPP Liner), LMK Enterprises (Performance Liner), Steven's Technologies (CIPP Liner 2 part 100% epoxy), Inner Cure Technologies (Reichold/Dion CIPP Liner), Lanzo Lining (Lanzo CIPP Lining System), and Premier Pipe (Premier Pipe CIPP Lining System). All other products must meet the specification herein and will require approval, as specified prior to installation.
- C. The materials used shall be designed, manufactured, and intended for sanitary sewer pipe relining and the specific application in which they are used. The materials shall have a proven history of performance in sewer relining and rehabilitation. All materials shall be stored and handled in accordance with recommendations of the manufacturer. All materials shall be installed in accordance with the manufacturer's written instructions.
- D. The finished pipe liner in place shall be fabricated from materials which when complete are chemically resistant to and will withstand internal exposure to domestic sewage having a pH range of 5 to 11 and temperatures up to 150°F.
- E. Take all necessary field measurements of the existing pipe (including diameter, ovality and length) prior to manufacturing liners.
- F. The minimum length shall be that deemed necessary by the Contractor to effectively span the distance from the inlet to the outlet of the respective manholes unless otherwise specified. The Contractor shall verify the lengths in the field before manufacturing.

2.02 STRUCTURAL REQUIREMENTS

- A. The liner shall be fabricated to a size that when installed will neatly fit the internal circumference of the conduit to be repaired as specified by the County.
- B. The minimum required structural CIPP wall thickness shall be based on the physical properties described above and in accordance with the design equations in the appendix of ASTM F 1216, and the following design parameters:

Design Considerations	Criteria
Tube Design	ASTM F 1216 Appendix X1
Hydrostatic Buckling	ASTM F 2561 Section 6.1 and 6.1.1
Design Safety Factor	2.0
Retention Factor for Long Term Flexural Modulus to be used in Design	50 %
Ovality	2 %
Groundwater Depth = Pipe Depth (above invert)*	100% depth from pipe to surface
Lining enhancement factor	7 maximum
Soil Modulus	1,000 psi
Soil Density	120 pcf
Live Load	One (1) H20 passing truck
Design Condition	Fully deteriorated

- C. The Contractor shall submit the structural design of the liner for sewers and laterals, signed and sealed by a Professional Engineer in the state of Florida, subject to review by the County.
 - 1. Design may be based on material properties of the liner that exceed the minimum values specified in ASTM F1216. However, the initial flexural modulus used in structural design calculations shall not exceed 400,000-psi.
- D. Each CIPP shall be designed to withstand internal and/or external loads as dictated by the site and pipe conditions. When not specified by the County in the contract documents, the design thickness of the CIPP shall be arrived at using standard engineering methodology as found in ASTM F1216. In no case shall the finished thickness of the cured liner be less than six millimeters. The long-term modulus shall not exceed 50 percent of the short-term value for the resin system and shall be verifiable through testing.
- E. When multiple layers are present, the layers of the finished CIPP shall be uniformly bonded. It shall not be possible to separate any two layers with a probe or point of a knife blade so that the layers separate cleanly or such that the knife blade moves freely between the layers. If separation of the layers occurs during testing of the field samples, new samples will be cut from the work. The composite of the materials will, upon installation inside the host pipe, exceed the minimum test standards specified by the American Society for Testing Methods. The CIPP design for the lateral tube shall assume no bonding to the original pipe, in accordance with ASTM F1216. Any reoccurrence may be cause for rejection of the work. The cured liner shall meet TABLE 02771 - 1 Minimum Physical Properties.

**Table 02771 - 1
Minimum Physical Properties**

Property	Standard	PSI
Tensile Strength	ASTM D638	4,000
Flexural Strength	ASTM D790	5,000
Flexural Modulus of Elasticity	ASTM D790	400,000
Modulus of Elasticity	ASTM D2990	150,000
Minimum Long-Term is 50-years		

2.03 CURED-IN-PLACE LINER

- A. All cured-in-place lining products shall comply with ASTM F-1216 or intent thereof as determined by the County.
- B. The flexible tube shall be fabricated to a size that when installed will neatly fit (minimum 99.75%) the internal circumference of the existing sanitary sewer lines (including services). Allowance shall be made for circumferential stretching during insertion so that the final cured product is snug against the wall of the host pipe.

- C. Unless otherwise specified, the Contractor will use a polyester filter felt tube and a resin and catalyst system compatible with the inversion process and having the physical properties for the cured pipe identified in Table 02771 - 1 Physical Properties.
- D. Resin Components
1. The resin system shall be a corrosion resistant epoxy vinyl ester or polyester that when properly cured within the tube composite meets the minimum requirements given herein or those that are to be utilized in the design of the CIPP for this project. The catalyst system may be accelerated to promote curing.
 2. The resin used shall not contain non-strength enhancing fillers.
 3. The Contractor shall submit the resin characteristics, including filler identification, to the County for approval prior to lining activities.
- E. CIPP liner systems using resins containing styrene or other regulated chemicals that will be discharged into the wastewater system shall require a pre-treatment plan to remove the regulated chemicals to acceptable levels prior to discharge.
- F. The Contractor shall submit the pre-treatment plan including design calculations to the County for approval prior to discharge. The information required shall include:
1. MSDS for all chemicals used in the process and that will be discharged into the wastewater system.
 2. Representative analytical data that was performed in the past for the proposed process, as collected from the wastewater stream.
 3. The addresses and mapped locations of the discharge.
 4. The total duration of discharge request.
 5. The anticipated discharge temperature. Discharges in excess of 140°F are not permitted.
 6. The Contractor shall submit for approval a summary table of pre-treatment design calculations in Excel containing the following information:
 - a. Dates of discharge of each section
 - b. Lining section numbers using the OCUD numbering system
 - c. Length and diameter of each section
 - d. Volume (in gallons) of inversion water of each section
 - e. Volume (in gallons) of cool down water of each section
 - f. Total volume (in gallons) of inversion and cooling water of each section
 - g. Regulated chemical (in pounds) in discharge volume of each section
 - h. Reduction chemical (in pounds) to meet post-treatment concentration limit
 - i. Reaction time period (in hours) to achieve post-treatment concentration limit
 - j. Cool down time period (in hours)
 - k. Regulated chemical post-treatment concentration limit (in PPM)
 7. The Contractor shall provide pre-treatment and post-treatment sampling and laboratory analysis of the process wastewater and submit the results to the County for verification.

PART 3 - EXECUTION

3.01 PREPARATION

- A. The following installation procedures shall be adhered to unless otherwise approved by the County.
- B. Prior to any lining of a pipe so designated, it shall be the responsibility of the Contractor to remove all internal debris and clean the existing sewer line and/or lateral in accordance with the recommendations of the liner manufacturer and in accordance with Section 02761 "Cleaning Sanitary Sewer Systems." Both mainline and lateral line shall be cleaned.
 1. It shall be the responsibility of the Contractor to remove all internal debris and clean the existing sewer line and/or lateral in accordance with the recommendations of the liner manufacturer prior to installation of the liner.
 - a. Preparation of the interior surface shall be accomplished by a thorough high-pressure water-jet cleaning. The pipe shall be left free of all loose sand, rock, or other deleterious materials. Any roots in the pipe shall be either removed or cut off flush with the interior.
 - b. If conditions such as broken pipe and major blockages are found that will prevent proper cleaning or where additional damage would result if cleaning is attempted or continued, the Contractor shall notify the County immediately. The County will determine what course of action will be taken to complete the project.
 - c. Precautions shall be taken by the Contractor to ensure that no damage or flooding of public or private property is caused by the cleaning operation.
 - d. The County shall inspect the prepared pipe for cleanliness and smoothness before the Contractor is authorized to proceed with pipe lining operations.
 2. Experienced personnel trained in locating breaks, obstacles and service connections by closed circuit television shall perform inspection of existing sewer lines. The interior of the line shall be carefully inspected in accordance with Section 02762 "Televising Sanitary Sewer Systems" to determine the location of laterals in any condition that may prevent proper installation of the liner pipe into the lines. Such conditions shall be noted so they can be corrected. A digital data video and a suitable log shall be prepared by the Contractor during the Work and provided to the County a minimum of two weeks prior to liner installation.
 3. The Contractor shall provide for the flow of sewage around the section or sections of pipe designated for lining as specified in Section 01516 "Collection System Bypass."
 - a. Flow control shall be exercised as required to ensure that no flowing sewage comes into contact with sections of the sewer under repair.
 - b. A sewer line plug shall be inserted into the sewer upstream from the section to be repaired. The plug shall be so designed that all or any portion of the sewage flows can be released. During the review, testing and installation portion of the operation, flows shall be shut off in order to properly install the cured-in-place pipe lining. The upstream manholes shall be constantly monitored for degree of surcharging. After the installation is complete, flows shall be restored to normal level.

- c. Wherever lines are blocked off and the possibility of backing up the sewage and causing harm to public and private property is foreseen, it shall be the Contractor's responsibility to bypass flow from manhole to manhole.
 - d. Bypassing shall be accomplished using sewer plugs with pump connections, by pumping down surcharged manholes, or by other methods acceptable to the County. All bypassed flow must be discharged to a sanitary sewer. Bypassed flow shall not be allowed to enter any storm line, drainage ditch or street gutter.
 - e. During a bypass operation, the pump shall be manned continuously; the Contractor shall maintain the pump and bypass equipment; and shall be responsible for any damages to public or private property due to the malfunction of same.
4. The Contractor shall clear the line of obstructions such as solids, dropped joints, protruding service connections or collapsed pipe that will prevent the insertion of the liner pipe. If inspection reveals an obstruction that cannot be removed by conventional sewer cleaning equipment, then the County shall be notified immediately.
 5. Do not install liner if ground water temperatures and/or ambient temperatures are excessive for the product installation procedures.
 6. Notification of Public or Customers: Customers shall be notified by the Contractor with door hanger advising the customers of when the Work will begin, expected date of completion, the type of work and contact person for any questions.
 7. Traffic Control: The Contractor shall provide all traffic control measures required for the safety of the public, workers and equipment during the Work and in accordance with FDOT and the County.
 8. The contractor shall provide critical backup equipment to insure that the lining operation progresses without interruption. Required backup equipment shall include at a minimum 1 additional lateral cutter system and 1 additional CCTV camera system.

3.02 PRE-TREATMENT OF REGULATED CHEMICALS TO DISCHARGE INTO SEWER

- A. CIPP liner systems using resins containing styrene or other regulated chemicals that will be discharged into the wastewater system shall require a pre-treatment plan to remove the regulated chemicals to acceptable levels prior to discharge. The Contractor shall submit the pre-treatment plan to the County for approval prior to discharge. The information required shall include:
 1. MSDS for all chemicals used in the process and that will be discharged into the wastewater system
 2. Representative analytical data that was performed in the past for the proposed process, as collected from the wastewater stream
 3. The addresses and mapped locations of the discharge
 4. The total duration of discharge request
 5. The anticipated discharge temperature. Discharges in excess of 140°F are not permitted
 6. The Contractor shall submit for approval a summary table of pre-treatment design calculations in Excel containing the following information:
 - a. Dates of discharge of each section

- b. Lining section numbers using the OCUD numbering system
 - c. Length and diameter of each section
 - d. Volume (in gallons) of inversion water of each section
 - e. Volume (in gallons) of cool down water of each section
 - f. Total volume (in gallons) of inversion and cooling water of each section
 - g. Regulated chemical (in pounds) in discharge volume of each section
 - h. Reduction chemical (in pounds) to meet post-treatment concentration limit
 - i. Reaction time period (in hours) to achieve post-treatment concentration limit
 - j. Cool down time period (in hours)
 - k. Regulated chemical post-treatment concentration limit (in PPM)
7. The Contractor shall provide pre-treatment and post-treatment sampling and laboratory analysis of the process wastewater and submit the results to the County for verification.

3.03 INSTALLATION

A. General

1. Alternative methods of liner insertion, pressurization, and processing may be used for products and processes approved by the County, and when the final liner product meets the intent of ASTM installation procedures as determined by the County. Installation shall be in accordance with manufacturer's recommendations, which shall be available for verification by the inspector. Should there be any difference between the requirements, the more stringent shall govern. Prior to construction, the Contractor shall submit to the County such written information which shall include, but not be limited to, storage and handling of liner before installation, preparing liner for installation, installing the liner in the sewer pipe, temperature and pressure requirements for inverting and setting the liner, curing and cool down procedures, end seals and service connections. The Contractor shall also submit to the County, a description of his methods for avoiding liner stoppage due to conflict and friction at such locations as the manhole entrance and the bend into the pipe entrance. The Contractor shall also present plans for dealing with a liner stopped by snagging within the pipe.
2. Seal the area where the line enters or leaves each manhole. Finish the inside of the manhole with a quick set cement grout to raise the invert to the grade of the liner pipe. Also use this grout to dress up around the end of the liner. This space may be sealed with a mechanical seal, chemical seal, or combination of both. The Contractor shall seal the liner at all manhole reconnections with an approved product, compatible with the liner, to completely seal any annular space present.
3. If the pipe liner fails to make a tight seal due to broken or misaligned pipe at the manhole wall or other reason, the Contractor shall apply a seal at that point.
4. The temperature of water discharged to the sewer system from processing liners shall not exceed 100°F maximum or the level allowed by State or Local standards. When draining water, care shall be exercised not to create a vacuum in the line.

5. After the liner has been installed, all active, existing services shall be temporarily reinstated to 100% of the original opening. This shall be done without excavation in pavement areas, and in the case of non-man-entry pipes, from the interior of the pipeline by means of a 360° (degree) television camera and a cutting device that re-establishes the service connection. When a remote cutting device is used and a cleanout is available, then a mini-camera down the service may also be used to assist the operator in cutting or trimming. All coupons shall be recovered at the downstream manhole and removed.
6. The Contractor shall immediately notify the County of any construction delays taking place during the insertion operation. Such delays shall possibly require sampling and testing by an independent laboratory of portions of the cured liner at the County's discretion. The cost of such test shall be borne by the Contractor and no extra compensation will be allowed. Any failure of sample tests or a lack of immediate notification of delay shall be automatic cause for rejection of that part of the Work at the County's discretion.
7. The cost for maintaining sanitary sewer service for the property owners during construction shall be included in the prices bid and no additional compensation will be allowed. Prior to construction, the Contractor shall submit to the County for review a complete description of the methods he intends to use to reconnect the existing laterals.

B. Cured-In-Place Liner

1. The Contractor shall designate a location where the reconstruction tube will be vacuum impregnated prior to installation. The Contractor shall allow the County to inspect the materials and "wet out" procedure. A catalyst system compatible with the resin and reconstruction tube shall be used. Sufficient excess resin will be provided to insure excretion into cracked pipe and or joints of the hot pipe after curing.
2. The wet out reconstruction tube shall be inserted through an existing manhole or other approved access by means of an inversion process, pulled in place process, or other approved method, and the application of a hydrostatic head, or equivalent pressure sufficient to fully extend it to the next designated manhole or termination point. The reconstruction tube shall be inserted into the vertical inversion standpipe with the impermeable plastic membrane side out. At the lower end of the inversion standpipe, the reconstruction tube shall be turned inside out and attached to the standpipe so that a leak proof seal is created. The inversion head will be adjusted to be of sufficient height to cause the impregnated tube to invert from manhole to manhole and hold the tube tight to the pipe wall, produce dimples at side connections and flared ends at the manholes. The use of a lubricant is recommended. Care shall be taken during the elevated curing temperature so as not to overstress the felt fiber.

3. After inversion is completed the Contractor shall supply suitable heat source and recirculation equipment. The equipment shall be capable of delivering the heat source throughout the section uniformly to raise the temperature above the temperature required to affect a cure of the resin. This temperature shall be determined by the resin/catalyst system employed. The system, together with the manufacturer's approval, shall be submitted to the County for review prior to lining operations. Temperatures shall be monitored and recorded throughout the installation process to ensure that each phase of the process is achieved at the manufacturer's recommended temperature levels. Copies of these records shall be given to the County at the completion of each installation.
4. The heat source shall be fitted with suitable monitors to gauge the temperature of the incoming and outgoing heat source. Another such gauge shall be placed between the impregnated reconstruction tube and the pipe invert at the remote manhole to determine the temperatures during cure. The resin manufacturer shall recommend temperature in the line during the cure period.
5. Initial cure shall be deemed to be completed when inspection of the exposed portions of cured pipe appear to be hard and sound and the remote temperature sensor indicates that the temperature is of a magnitude to realize an exotherm. The cure period shall be of a duration recommended by the resin manufacturer, as modified for the cured-in-place inversion process, during which time the recirculation of the heat source and cycling of the heat exchanger to maintain the temperature continues. Contractor shall retain a resin-impregnated sample (wick) to provide verification of the curing process taking place in the host pipe.
6. The Contractor shall cool the hardened pipe to a temperature below 100°F before relieving the static head in the inversion standpipe. Cool-down may be accomplished by the introduction of cool water into the inversion standpipe to replace water being drained and disposed per the approved pre-treatment plan. Care shall be taken in the release of the static head so that a vacuum will not be developed that could damage the newly installed pipe.

C. Service Lateral Renewal

1. The exact location and number of service connections or side sewers shall be verified during the initial television inspection. It shall be the Contractor's responsibility to accurately field locate all existing service connections or side sewers and establish means for access for flow control. The Contractor shall reconnect all service connections or side sewers to the liner pipe as indicated in accordance with the Contract Documents.
2. The Contractor shall be responsible for restoring/correcting, without any delay, all missed or faulty reconnections, as well as any damage caused to property owners for not reconnecting the services soon enough or for not giving notice to the property owners.
3. Any lateral not initially reinstated by the Contractor that proves to be active shall be reinstated by the Contractor at no additional cost to the County and the Contractor shall be responsible for any resulting property damage of floods.

4. All existing service connections shall be reconnected by a remote controlled cutting device directed internally by a television camera or by internal manual cutting. Cuts shall be made by experienced operators so that no blind attempts or holes are made in the liner pipe. Locations shall be verified carefully to match earlier tapes for accurate lateral location, especially where dimples are not well defined. The County reserves the right to require service connection by excavation at the Contractor's expense at any location if the quality or workmanship of the cut is not satisfactory.
5. A 2-pass process of utilizing a cutter to open the lateral followed by wire brush (or similar) attachment to complete the cutting flush with the lateral walls should be utilized, or approved alternate. It shall be properly aligned, invert to invert, to the existing connection with no obstructions to the flow. Resin slugs shall be removed as necessary from reinstated service connections. Any mis-cuts shall be repaired at no cost to the County and shall be performed utilizing an additional thinner liner to prevent water from entering behind the liner to the full satisfaction of the County. All coupons cut from the liner for reopening of lateral connections shall be retrieved from the sewer, accounted for by the Contractor, and turned over to the County.
6. All service connections and side sewers to be reconnected to the main sewer, shall be cleaned up to a length of 1-foot from the inside face of the existing wall of the main pipe. All deposits within the first foot of the service connection or side sewer in the service connections shall be removed and laterals reinstated.
7. Contractor shall provide a sound, smooth transition from laterals/side sewers to the main sewer. Any gaps between the liner and face of lateral/side sewer connections shall be completely filled and sealed with epoxy material compatible with the liner and host pipe. After installation of the liner and reinstatement of the lateral/side sewer, all repaired lateral/side sewer connections shall be sealed with 1/4-inch thickness epoxy material compatible with the liner and repair material from the liner connection to 1-foot from the inside face of the main sewer.
8. For PVC laterals or laterals that have been previously lined with cured-in-place pipe the Contractor shall take care during the reinstatement to avoid damage to the lateral pipe. A 2 pass process of utilizing a cutter to open the lateral followed by wire brush (or similar) attachment to complete the cutting flush with the lateral walls should be utilized, or approved alternate.

3.04 POST INSTALLATION

- A. Where liners of any type are installed in 2 or more continuous manhole segments, the liner invert through the intermediate manholes shall be left intact. Final finishing of the installation in those intermediate manholes shall require removal of the top of the exposed liner and neat trimming of the liner edge where it touches the lip of the manhole bench.
- B. Portions of any piece of liner material removed during installation shall be available for inspection and retention by the County.

- C. Reinstate openings for all drop assemblies after relining mainline sewer. Everywhere possible, outside drop assemblies shall be lined with a cured-in-place liner compatible with the mainline liner, for the full length of the drop assembly and bend. The vertical pipe shall be lined, at a minimum. Drop assemblies inside of manholes are not required to be relined, unless directed by the County.
- D. Each line segment lined shall be TV inspected in accordance with Section 02762 "Televising Sanitary Sewer Systems" as soon as practical after processing to assure complete curing. The liner shall be continuous and free of all visual and material defects except those resulting from pre-lined conditions (such conditions shall be brought to the attention of the County prior to lining). There shall be no damage, deflection, holes, delaminating, uncured resin or other visual defects in the liner. The liner surface shall be smooth and free of waviness throughout the pipe. No visible leakage through the liner or at manhole or service lateral connections will be allowed. Any defects located during the inspection shall be corrected by the Contractor to conform to the requirements of the specifications and to the satisfaction of the County. The Contractor shall not reactivate any section of lined sewer pipe until authorized to do so by the County. Segments not fully conforming to these Specifications must be immediately brought to the County's attention with a proposed method of correction.

3.05 TESTING

- A. After completing the lining, service renewals where required, and manhole rehabilitation/replacement, every liner and manhole shall be CCTV inspected as per Section 02762 "Televising Sanitary Sewer Systems."
- B. The Contractor shall have an independent testing lab analyze finished liner samples taken from manhole cutoffs, service coupons, etc.
 - 1. A minimum of 1 sample shall be taken of the first segment installed, or as directed by the County.
 - 2. A minimum of 2 samples shall be taken for each 2,500 lineal feet of liner material installed or for each manufacturing lot, if less, or as directed by the County.
 - 3. A minimum of 6 samples per project shall be taken for each type of liner furnished, or as directed by the County.
 - 4. Tests in accordance with ASTM standards for Tensile Properties, Flexural Modulus and wall thickness shall be conducted.
 - 5. The Contractor shall determine sampling location and procedures to ensure representative samples are obtained from the finished liner, subject to approval by the County.
 - 6. The Contractor shall furnish removable sizing sleeves, when possible, to collect liner samples, which accurately replicate the host pipe diameter.

3.06 ACCEPTANCE

- A. It is the intent of these specifications that the completed liner with all appurtenances shall be essentially equivalent in final quality and appearance to new sewer installation.

- B. The finished liner shall be continuous over the entire segment between manholes and homogenous throughout.
- C. The finished liner shall be fully rounded and as free as commercially practicable from visible defects, including but not limited to damage, deflection, holes, delamination, ridges, cracks, uncured resin, foreign inclusions or other objectionable defects.
- D. There shall be no visible infiltration through the liner, around the liner at manhole connections, at lined service connections or in lined services. Contractor shall repair any visible leaks.
- E. Where a defect in the liner requires removal of a section of the liner in the County's opinion, the Contractor shall make all repairs as required by the County and shall install a segmental liner, compatible with the liner, to accomplish a continuous finished liner. No separate payment will be made for such defect repair or for the post-repair segmental liner.
- F. The pipe shall be neatly and smoothly cut off at each manhole. The manhole trough shall be raised to the invert of the liner to preclude snagging and shoaling of debris.
- G. Service Connections
 1. The CIPP lateral lining shall not inhibit the CCTV post video inspection of the mainline or service lateral pipes.
 2. Reinstatement of all building sewer connections shall be done neatly and smoothly.
 3. The Contractor shall install any missing clean outs at the road right-of-way.

3.07 CLEAN-UP AND RESTORATION

- A. The Contractor shall not allow the site of the Work to become littered with trash and waste material, but shall maintain the site in a neat and orderly condition throughout the construction period.
- B. On or before completion, the Contractor shall clean and remove from the site of the Work all surplus and discarded materials, temporary structures, stumps and portions of trees, and debris of any kind. He shall leave the site of work in a neat and orderly condition, similar or equal to that prior to construction.
- C. All private and public property along or adjacent to the Work disturbed by construction operations shall be restored to a condition similar or equal to that existing prior to construction.
- D. Before final acceptance by the County, the Contractor shall replace and/or restore any water, sewer, drain, and gas lines and appurtenances; electrical, telephone, telegraph conduits and wires, both underground and aboveground, and appurtenances; traffic signals, fire and police alarm systems and appurtenances; sidewalks, curbs, gutter, drainage ditches and pavements and all other public utility facilities and appurtenances along or adjacent to the Work that may have been disturbed by construction operations.

- E. Conditions permitting, property cleanup and restoration shall begin and be prosecuted to completion on a timely basis as set forth herein.

3.08 PRIVATE SEWER LATERAL SHUTDOWN

- A. When it is necessary to shutdown a private sewer lateral while work is in progress and before the laterals are reconnected, the residents are to be notified by the Contractor at least 1-day prior to the shutdown. No sewer or water service is to remain shutdown for more than a period of 8-hours unless the Contractor provides substitute services for the residents. Commercial sewer services shall be maintained at all times that the business is open. No sewage from the services or main line shall be discharged on the ground or in waterways. Holding pits or tanks are not allowed unless permitted by the State. Contractor shall coordinate pump stations, force main and sanitary sewer operation, bypass and shutdown control with the County.

3.09 PROSECUTION OF WORK

- A. The Contractor is cautioned that only those sewer services that are live and active shall be repaired or reinstated after the sewer main has been lined or replaced.
- B. The Contractor shall note that not all sewer lines segments have been televised in their entirety due to obstructions blocking further entry, etc. These obstructions shall be cleared to allow TV viewing of the entire segment length before lining is commenced.
- C. The number of service connections on some sewer segments may exceed the number of buildings actually served. It is the Contractor's responsibility to determine through dye testing, or other acceptable methods, the services that are live and require reinstatement prior to commencing lining of the sewer main. Services that are confirmed to be inactive shall not be reconnected. Services that are inactive, but reinstated, shall be plugged at the Contractor's expense.
- D. Inactive services to vacant parcels shall be renewed, unless otherwise directed by the County.

3.10 WARRANTY INSPECTION

- A. The County shall conduct the warranty television inspection within 1-year after the date of acceptance. Any defective sections of liner located during the inspection shall be promptly repaired or replaced by the Contractor as directed by the County. In the event that a sewer liner or service connection is found to be leaking during the inspection, the Contractor shall be required to promptly replace it with a new section of pipe or liner or, if approved by the County, to eliminate the leak(s) by other means of repair.

END OF SECTION

THIS PAGE LEFT BLANK INTENTIONALLY

SECTION 02774
WASTEWATER GRAVITY COLLECTION SYSTEM

PART 1 - GENERAL

1.01 DESCRIPTION

- A. Scope of Work: Construction of sanitary sewers, sewer connections and appurtenances as shown on the Drawings or specified herein.

1.02 QUALITY ASSURANCE

- A. Storage: PVC pipe shall be stored on level ground, preferably turf or sand, free of sharp objects which could damage the pipe. Stacking of the PVC pipe shall be limited to a height that will not cause excessive deformation of the bottom layers of pipes. Where necessary, due to ground conditions, the pipe shall be stored on wooden sleepers, spaced suitably and of such width as not to allow deformation of the pipe at the point of contact with the sleeper or between supports.
- B. Tests: Certified records of tests made by the manufacturer or by a reliable commercial laboratory shall be submitted with each shipment of pipe. All pipe shall be inspected upon delivery and that which does not conform to the requirements of these specifications shall be rejected and must be immediately removed by the Contractor. The Contractor shall furnish and provide samples of pipe for the performance of such additional tests as the County may deem necessary.

1.03 SHOP DRAWINGS AND SUBMITTALS

- A. Submittals shall be submitted to the County for review and acceptance prior to construction in accordance with the General Conditions and specifications Section 01300 "Submittals."
 - 1. Precast manholes
 - 2. Manhole frames, covers, and other castings
 - 3. Manufacturer's certified test report on castings
 - 4. Certification of admix installation from pre-caster
 - 5. Certified test records for polyvinyl chloride pipe
 - 6. Mill Test Certificates on ductile iron pipe
 - 7. Manhole pipe connections
 - 8. Coal tar epoxy
 - 9. Special interior linings
- B. Record Information: The Contractor shall submit to the County the elevations of the center of the manhole covers and inverts of all pipes in the manholes.

PART 2 - PRODUCTS

2.01 GENERAL

- A. All material supplied shall be one of the products specified in Appendix D "List of Approved Products" appended to these technical specifications.

2.02 MATERIALS

- A. Ductile Iron Pipe and Fittings: Ductile iron pipe shall meet the requirements of Section 15062 "Ductile Iron Pipe and Fittings."
- B. Polyvinyl Chloride Pipe and Fittings: Polyvinyl Chloride (PVC) Pipe shall meet the requirements of Section 15064 "Polyvinyl Chloride Pipe and Fittings."
- C. Precast Concrete Manholes
 - 1. Precast manholes shall conform to the requirements of ASTM Designation C 478.
 - a. The minimum shell thickness shall be 5-inches.
 - b. Lifting holes through the structures are not permitted.
 - c. The design of the structure shall include a precast base of not less than 8-inches in thickness poured monolithically with the bottom section of the manhole walls.
 - d. Where drop structures are required, the design of the structure shall include a precast base, for the drop structure, of not less than 8-inches in thickness poured monolithically with the bottom section of the manhole walls.
 - e. New manholes shall contain a crystalline waterproofing concrete admix. Crystalline waterproofing concrete admix shall be added to the concrete during the batching operation. Admix concentration shall be added based upon manufacturer design percent concentration of admixture to the required weight of cement. The amount of cement shall remain the same and not be reduced. A colorant shall be added to verify the admix was added to the concrete for all precast manholes. Colorant shall be added and provided at the admix manufacturing facility, not at the concrete batch plant. Contractor shall provide certification from the pre-caster that the admix was installed in accordance with the manufacturers recommendations.
 - 2. Top sections shall be eccentric, except that concrete top slab shall be used where shallow cover requires a top section less than 3-feet deep.
 - 3. New manholes shall be lined with Interior Linings where shown on the Drawings.
- D. Concrete and Reinforcing Steel: Concrete and reinforcing steel shall conform to the requirements of Division 3 - Concrete. Concrete classes for the various purposes shall be as follows:
 - 1. Manhole bottoms, Class A
 - 2. Precast manholes, Class A (4,000-psi)
 - 3. Pipe and riser encasement, Class C
 - 4. Protective slabs, Class C

- E. Castings: Gray iron castings for manhole frames, covers, adjustment rings, and other items shall conform to the ASTM Designation A 48, Class 30. Castings shall be true to pattern in form and dimensions and free of pouring faults and other defects in positions which would impair their strength, or otherwise make them unfit for the service intended. No plugging or filling will be allowed. Lifting or "pick" holes shall be provided, but shall not penetrate the cover. Casting patterns shall conform to those shown or indicated on the Drawings. The words SANITARY and ORANGE COUNTY, FLORIDA shall be cast in all manhole covers as shown on the Drawings. All manhole frames and covers shall be traffic bearing to meet AASHTO H-20 loadings unless otherwise specified.
- F. Brick: Brick for manhole construction shall be dense, hard burned, shale, or clay brick conforming to ASTM Designation C 32, Grade MM or C 62, Grade MW, except that brick absorption shall be between 5 and 25-grams of water absorbed in 1-minute by dried brick, set flat face down, in 1/8-inch of water.
- G. Cement Mortar: Cement mortar for manhole construction shall comply with ASTM Designation C 270, Type M, except that the cement shall be Portland Type II only. No mortars that have stood for more than 1-hour shall be used.
- H. Pipe Adapter: Connection of PVC gravity sewer lines to precast manholes and wetwells shall be made by using a flexible boot type manhole coupling adapter.
- I. Interior Linings (existing structures): Interior surfaces of existing manholes and wetwells shall be coated or lined to resist corrosion where shown on the Drawings. Coatings and linings shall meet the requirements of Section 09901 Coatings and Linings.
- J. Interior Linings (proposed structures): Interior surfaces of new wetwells shall be lined. Interior surfaces of new manholes shall be lined where shown on the Drawings. Coatings and linings shall meet the requirements of Section 09901 Coatings and Linings.
- K. Joint Sealer: Joint sealer material for precast manhole structures shall be pre-formed flexible plastic conforming to Federal Specification SS-S-00210 (GSA-FSS). Seal all exterior joints with Portland Type II cement after setting of joint sealer and placement of manhole section to form a watertight joint.
- L. Non-Shrink Mortar: Non-shrink mortar shall be used for filling annular spaces and holes in precast manholes and wetwells.
- M. Manhole Encapsulation: Manhole cones, riser rings, iron frame, cover, and all joints shall be encapsulated with a heat shrink-wrap with a minimum thickness of 98-mils (2.5-mm).
 - 1. Wrap shall have a cross-linked polyolefin backing coated with a protective heat activated adhesive. The wrap shall effectively bond to the substrate via primer provided by the manufacturer. The wrap shall be applied with a high intensity propane torch.
 - 2. Heat shrink-wrap for all barrel section joints of manholes shall be a minimum 9-inch width. Corbel section, riser rings, and ring and cover shall have a minimum 12-inch width wrap.
 - 3. Adhesive tap materials shall not be allowed.

PART 3 - EXECUTION

3.01 PREPARATION

- A. Upon satisfactory excavation of the pipe trench, as specified in Section 02220 "Excavating, Backfilling and Compacting" a continuous trough for the pipe barrel and recesses for the pipe bells shall be excavated by hand digging so that, when the pipe is laid in the trench, true to line and grade, the pipe barrel will receive continuous uniform support and the bell will receive no pressure from the trench bottom.
- B. The interior of all pipe shall be thoroughly cleaned of all foreign material before being lowered in the trench and shall be kept clean during laying operations by means of plugs or other approved methods.

3.02 INSTALLATION

A. Sewer Pipe

1. General

- a. Laying of pipe shall proceed upgrade with spigot ends pointing in the direction of flow. Before pipe is joined, gaskets shall be cleaned of all dirt, stones, and other foreign material. The spigot ends of the pipe and/or pipe gaskets shall be lubricated lightly with a lubricant as specified by the pipe manufacturer and approved by the County. Sufficient pressure shall be applied to the pipe so as to properly seat the socket into the bell of the pipe. Any damage to the pipe due to over-exertion shall be replaced at the Contractor's expense. All pipe shall be laid straight, true to the lines and grades shown on the Drawings.
- b. Variance from established line and grade, at any point along the length of the pipe, shall not be greater than 1/32-inch per inch of pipe diameter and not to exceed 1/2-inch, provided that any such variation does not result in a level or reverse sloping invert.
- c. Any pipe, which is disturbed or found to be defective after installation, shall be taken up and relayed or replaced at the Contractor's expense.
- d. Approved utility crossing signs shall be placed on the pipe alignment at each side of any waterway crossing.

2. PVC Pipe

- a. Handling PVC pipe: The handling of PVC pipe shall be in such a manner that the pipe is not damaged by dragging it over sharp and cutting objects. Sections of pipe with deep cuts and gouges shall be removed and discarded at no expense to the County.
- b. Lowering pipe into trench: Care shall be exercised when lowering pipe into the trench to prevent damage to or twisting of the pipe.

3. Building Laterals/Service Connections

- a. Service connections shall be constructed in accordance with the details as indicated on the Drawings.
- b. Sewer lateral pipe shall be extended to the right-of-way and plugged at the right-of-way line to avoid leakage (unless otherwise indicated on the Drawings). All connections and changes of direction shall be made using standard fittings designed for that purpose.
- c. Locator balls shall be placed under all sanitary sewer service cleanouts.

- d. On curbed streets, the exact location for each service connection shall be marked by etching or cutting an "S" in the concrete curb. Where no curb exists or is planned, locations shall be marked by a method approved by the County.
4. PVC C-900 DR 14 Pipe Section: PVC C-900 DR 14 pipe shall be substituted for the specified PVC pipe where:
 - a. The sewer or service pipe is to be constructed with less than 30-inches of cover between the top of the pipe and the final top of pavement or ground line.
 - b. The PVC sewer main crosses over a water main, or is at a depth which results in less than 18-inches clear distance between pipes when crossing under a water main. The DR 14 pipe shall extend a minimum of 10-feet on each side of the point of crossing.
 - c. The lateral separation of the sewer pipe and potable water piping is less than 10-feet.

B. Manholes:

1. Manhole excavation and bedding at manhole junctions shall be performed in accordance with the provisions of Section 02220 "Excavating, Backfilling and Compacting" of these specifications.
2. The invert channels shall be smooth and accurately shaped to a semicircular bottom conforming to the inside of the adjacent sewer section using 2,500-psi concrete. Steep slopes outside the invert channels shall be avoided. Changes in size and grade shall be made gradually and evenly. Changes in the direction of the sewer or entering branch shall be a smooth curve with radius as long as practicable. Invert channels shall also be formed for pipe stubouts.
3. The first pipe joint outside the manhole shall be located a minimum distance of 24-inches from the outside surface of the manhole.
4. Precast manhole tops shall terminate at such elevations to permit laying brick courses under the manhole frame to make allowance for future street grade adjustments.
5. Frames and covers shall be set accurately to conform to the finished grade.
6. Outside drop connections shall be made in accordance with the details shown on the Drawings.
7. Drop connection base slab extensions on precast manholes shall be manufactured monolithically with the manhole elements at the casting yard. The manufacturer shall submit for approval the method of drop manhole construction.
8. Where additional pipe connections or modifications of existing factory made openings are required on new or existing precast concrete manholes or wetwells, all cutting relative thereto shall be performed only by a power driven abrasive wheel or saw. It is specifically noted that such connections to existing manholes or wetwells shall be installed in accordance with the details for new units shown on the Drawings, and shall be caulked watertight with non-shrink grout.
9. Connection of the pipe entering the manhole shall be made by using a flexible boot type manhole coupling adapter. At the entry into the manhole, no part of the horizontal pipe shall rest against the concrete.
10. Manholes shall be completed as the work progresses so that testing may be conducted as prescribed in paragraph 3.03 Field Quality Control.

- C. Concrete encasement: Class C concrete encasement shall be constructed in accordance with details shown on the Drawings.

1. The County may order the line encased when:
 - a. The sewer main crosses over a water main, or is at a depth which results in less than 18-inches clear distance between pipes when crossing under a water main. Encasement shall extend a minimum of 10-feet on each side of the point of crossing. In lieu of encasement, the sewer line may be constructed of PVC DR 14 pipe and shall be laid such that both joints will be a distance of 10-feet from the crossing.
 - b. The maximum width for trench excavations is exceeded. The Contractor shall construct concrete encasement around the pipe for the length of the excessive excavation. No payment will be made for the concrete encasement required due to excessive trench widths.
2. The points of beginning and ending of pipe encasement shall be not more than 6-inches from a pipe joint to protect the pipe from cracking due to uneven settlement of its foundation or the effects of superimposed live loads.

D. Concrete protective slabs: Concrete protective slabs as shown on the Drawings shall be constructed over gravity sewers that have less than 3-feet of cover from finished grade.

E. Connections to existing structures: Proposed sewer lines shall be connected to the existing manholes by core drilling the proper size opening and installing a flexible boot type manhole adapter as specified in paragraph 2.01.H of this Section.

F. Invert channels (benching) shall be provided for all new manholes and existing manholes which are connected into. No brick shall be allowed in construction of the manhole invert. Inverts shall be poured using 2,500-psi concrete.

3.03 FIELD QUALITY CONTROL

A. Workmanship: Sewers and appurtenances shall be built watertight. The sewage must be pumped for disposal and special care and attention must be paid to securing watertight construction. Upon completion, the sewers, or sections thereof, will be tested and gauged and if leakage is above the allowable limits specified, the sewer will be rejected.

B. Inspection: On completion of each block or section of sewer, or such other times as the County may direct, the block or section of sewer shall be cleaned, tested, and inspected.

1. Each section of the sewer shall show, on examination from either end, a full circle of light between manholes.
2. Each manhole or other appurtenance to the system shall be of the specified size and form, be watertight (no leakage allowed by visual inspection), and be constructed with the top set permanently to specified position and grade. All repairs shown necessary by the inspection shall be made; broken or cracked pipe replaced; all deposits removed and the sewer left true to line and grade, entirely clean and ready for use.
3. No pipe shall exceed a deflection of 5%. After the final backfill has been in place at least 30-days, the Contractor shall perform deflection testing using a rigid ball or mandrel with a diameter of not less than 95% of the base inside diameter or average inside diameter of the pipe, depending which is specified in the ASTM standard to which the pipe is manufactured. If the mandrel does not pass the completed section of sewer, the entire section of sewer will be rejected.

C. Closed Circuit Television Inspection:

1. Internal gravity sewer video inspection shall be performed by the Contractor to check for alignment and deflection. The television inspection shall also be used to check for cracked, broken, or otherwise defective pipe and overall pipe integrity.
2. The video internal inspection will be performed in 2 stages. The first inspection shall be within 30-days after the installation of the gravity sewer pipe provided the road base is in place and the manhole rings and covers are to grade. The second inspection of the gravity sewer pipe shall be before the end of the 1-year warranty period.
3. If the first or second video inspection reveals cracked, broken, or defective pipe, or pipe misalignment resulting in vertical sags in excess of 1-1/2-inch or a ring deflection in excess of 5%, the Contractor shall be required to repair or replace the pipeline. Successful passage of both the low-pressure air exfiltration test and video inspection is required before acceptance by the County.
4. Prior to repair or replacement of failed sewer pipe, the method of repair or replacement shall be submitted to the County for approval. Pressure grouting of pipe or manholes shall not be considered as an acceptable method of repair.

D. Low Pressure Air Exfiltration Testing:

1. The Contractor shall provide all labor, equipment, and materials and shall conduct all testing required under the direction of the County
2. Low pressure air testing shall conform to the requirements of UNI-B6-79 "Recommend Practice for Low-Pressure Air Testing of Installed Sewer Pipe", as published by UNI-Bell Plastic Pipe Association.
3. During sewer Construction, all service laterals, stubs, and fittings into the sewer test section shall be properly capped or plugged so as not to allow for air loss that could cause an erroneous air test result. Where necessary, the Contractor shall restrain caps, plugs, or short pipe lengths such that blowouts are prevented.
4. Each test section shall not exceed 400-feet in length and shall be tested between adjacent manholes.
5. Before testing, Contractor shall install monitoring wells at each manhole to determine groundwater level and adjust test pressure accordingly. In no case shall the test pressure exceed 9.0-psig. All pressurizing equipment shall include a regulator or relief valve set no higher than 9.0-psig to avoid over-pressurizing.
6. Low-pressure air shall be slowly introduced into the sealed line until the internal air pressure reaches 4.0-psig greater than the average backpressure of any groundwater above the invert of the pipe, but not greater than 9.0-psig.
7. When temperatures have been equalized and pressure stabilized at 4.0-psig greater than the average groundwater backpressure, the air hose from the control panel to the air supply shall be shut off or disconnected. The continuous monitoring pressure gauge shall then be observed while the pressure is decreased to no less than 3.5-psig greater than the average groundwater backpressure. At a reading of 3.5-psig greater than the average groundwater backpressure, timing shall commence with a stopwatch or other timing device that is at least 99.8% accurate.
8. If the time shown in the table, for the designated pipe size and length, elapses before the air pressure drops 1-psig; the section under-going test shall have passed. The test may be discontinued once the prescribed time has elapsed.

9. If the pressure drops 1-psig before the appropriate time shown in the table has elapsed, the air loss rate shall be considered excessive and the section of pipe has failed the test.
10. Should the section fail to meet test requirements, the Contractor shall determine the source or sources of leakage, and make all necessary repairs and shall repeat the test until the test section is within established limits. All corrective work shall be at the Contractor's expense.

E. Correction of Non-Conforming work:

1. All non-conforming work shall be repaired or replaced by the Contractor at no additional expense to the County. Non-conforming work shall be defined as failure to adhere to any specified or implied directive of these technical special provisions and/or the Drawings, including but not limited to pipe not laid straight, true to the lines and grades as shown on the Drawings, damaged or unacceptable materials, misalignment or diameter ring deflection in pipe due to bedding or backfilling, water standing in any pipe segment or structure, visible or detectable leakage, and failure to pass any specified test or inspection.

**Table 02774-1
Test Time Table**

TEST TIME: For sewer diameter between 8 inches and 36 inches inclusive, the pipe shall be tested between adjacent manholes. The test time for the air pressure to drop the specified one pound shall be as listed below:											
SPECIFICATION TIME REQUIRED FOR A 1.0 PSIG PRESSURE DROP											
1 Pipe Dia. (in.)	2 Minimum Time (min:sec)	3 Length for Minimum Time (ft)	4 Time for Longer Length (sec)	Feet							
				100	150	200	250	300	350	400	450
6	5:40	398	0.854 L	5:40	5:40	5:40	5:40	5:40	5:40	5:42	6:24
8	7:34	298	1.520 L	7:34	7:34	7:34	7:34	7:36	8:52	10:08	11:24
10	9:26	239	2.374 L	9:26	9:26	9:26	9:53	11:52	13:51	15:49	17:48
12	11:20	199	3.148 L	11:20	11:20	11:24	14:15	17:05	19:56	22:47	25:38
15	14:10	159	5.342 L	14:10	14:10	17:48	22:15	26:42	31:09	35:36	40:04
18	17:00	133	7.692 L	17:00	19:13	25:38	32:03	38:27	44:52	51:16	57:41
21	19:50	114	10.470 L	19:50	26:10	34:54	43:37	52:21	61:00	69:48	78:31
24	22:40	99	13.674 L	22:47	34:11	45:34	56:58	68:22	79:46	91:10	102:33
27	25:30	88	17.306 L	28:51	43:16	57:41	72:07	86:32	100:57	115:22	129:48
30	28:20	80	21.366 L	35:37	53:26	71:13	89:02	106:50	124:38	142:26	160:15
36	34:00	66	30.768 L	51:17	76:55	102:34	128:12	153:50	179:29	205:07	230:46

END OF SECTION

SECTION 02775
WASTEWATER MANHOLE REHABILITATION

PART 1 - GENERAL

1.01 DESCRIPTION

- A. Scope of Work: Sanitary sewer manhole rehabilitation including:
 - 1. Rehabilitation and leak proofing of manholes by coating with spray applied or centrifugally cast light-weight structural reinforced concrete, spray applied epoxy resin systems, or equal as determined by County.
 - 2. The repair and sealing of the manhole base, invert, walls, corbel/cone, and chimney of brick, block, or precast manholes, including the removal of any unsound material.
 - 3. The inspection and testing of the various types of work to insure compliance.

1.02 REFERENCES

- A. Codes, Specifications, and Standards (Not Used)
- B. Testing and Materials Standards
 - 1. American Society of Testing and Materials (ASTM)
- C. Related Sections
 - 1. Section 01516 "Collection System Bypass"
 - 2. Section 02774 "Wastewater Gravity Collection Systems"

1.03 DEFINITIONS (NOT USED)

1.04 RESPONSIBILITY FOR OVERFLOWS AND SPILLS

- A. It shall be the responsibility of the Contractor to schedule and perform his work so as to result in no overflows or spills of sewage from the system. If sewage flows are such that they interfere with the Contractor's ability to perform work, the Contractor shall be responsible for scheduling his work during low flow periods or provide bypass pumping. Bypass pumping shall be provided only with the specific written approval of the County.
- B. In the event of overflows caused by the Contractor's work activities, the Contractor shall immediately take appropriate action to contain and stop the overflow, clean up the spillage, disinfect the area affected by the spill, and notify County in a timely manner.

- C. Contractor will indemnify and hold harmless the County for any fines or third-party claims for personal or property damage arising out of a spill or overflow that is fully or partially the responsibility of the Contractor. Should fines subsequently be imposed as a result of any overflow for which the Contractor is fully or partially responsible, the Contractor shall pay all such fines and all of the County's legal, engineering, and administrative costs in defending such fines and claims associated with the overflow.

1.05 SHOP DRAWINGS AND SUBMITTALS

- A. Shop Drawings shall be submitted to the County for review and acceptance prior to starting construction in accordance with the General Conditions and 01300 "Submittals" for the following:
 - 1. Manhole Coating
- B. Submittals shall be submitted to the County for review and acceptance at least 14-days prior to starting manhole rehabilitation in accordance with the General Conditions and Division 1 for the following:
 - 1. Manufacturers' Certificate of Compliance certifying compliance with the applicable Specifications and Standards. The certifications shall list all materials furnished under this Section.
 - 2. Certified copies of factory tests required by the applicable Standards, the Manufacturer, and this Section.
 - 3. Manufacturer's handling, storage, and installation instructions and procedures.
 - 4. Recommended coating thickness design to withstand groundwater pressure as specified in Part 3 of this Section.

PART 2 - PRODUCTS

2.01 GENERAL

- A. Materials
 - 1. All materials furnished for this work shall be in accordance with the "List of Materials and Approved Manufacturers" as appended to these Specifications.
 - 2. The materials used shall be designed, manufactured, and intended for sewer manhole rehabilitation and the specific application in which they are used. The materials shall have a proven history of performance in sewer manhole rehabilitation. The materials shall be delivered to the job site in original unopened packages clearly labeled with the manufacturer's identification and printed instructions. All materials shall be stored and handled in accordance with recommendations of the manufacturer. All materials shall be mixed and applied in accordance with the manufacturer's written instructions.
 - 3. The Contractor shall warrant and hold harmless the County against all claims for patent infringement and any loss thereof.
 - 4. Handle and store all materials and dispose of all wastes in accordance with applicable regulations.

5. Each coating system shall be designed for application over wet surfaces (but not active running water) without degradation of the final product and/or the bond between the product and the manhole surfaces.
- B. The following shall be used for stopping active leaks in concrete and masonry manholes:
1. A premixed fast-setting, volume-stable waterproof cement plug consisting of hydraulic cement, graded silica aggregates, special plasticizing, and accelerating agents. It shall not contain chlorides, gypsum's, plasters, iron particles, aluminum powder, or gas-forming agents, or promote the corrosion of steel it may come in contact with. Set time shall be approximately 1-minute. Ten (10) minute compressive strength shall be approximately 500-psi.
 2. A silicate-based liquid accelerator field mixed with neat Portland cement. The set time shall be approximately 1-minute.
 3. The elastomeric polyurethane resin-soaked method, using dry twisted jute oakum, or resin-rod with polyurethane resin (water activated).
- C. The following shall be used for patching, repointing, filling, and repairing non-leaking holes, cracks, and spalls in concrete and masonry manholes:
1. A premixed non-shrink cement-based patching material consisting of hydraulic cement, graded silica aggregates, special plasticizing and accelerating agents, which has been formulated for vertical or overhead use. It shall not contain chlorides, gypsums, plasters, iron particles, aluminum powder, or gas-forming agents or promote the corrosion of steel with which it may come into contact. Set time (ASTM C-191) shall be less than 30-minutes. One-hour compressive strength (ASTM C-109) shall be a minimum of 200-psi and the ultimate compressive strengths (ASTM C-882-Modified) shall be a minimum of 1,700-psi.
- D. Spray applied or centrifugally cast structural reinforced cement manhole coating
1. The material applied to the surface of the manhole shall be a cementitious blend of calcium aluminate cement and manufactured calcium aluminate aggregates for constructing a coating that is impervious to the flow of water, is resistant to sulfide attack, and restores structural integrity to existing manhole walls.
 2. A monolithic coating shall be formed which covers all interior manhole surfaces and shall have the following minimum requirements at 28-days:

Compressive Strength (ASTM C-579B)	3,000-psi
Tensile Strength (ASTM C-496)	300-psi
Flexural Strength (ASTM C-293) (Modified)	600-psi
Shrinkage (ASTM C-596)	0% at 90% R.H.
Bond (ASTM C-321)	130-psi
Density, when applied	105± pcf
- E. Spray applied epoxy resin system manhole coating.
1. The material sprayed onto the surface of the manhole shall be an epoxy resin system formulated for application within a sanitary sewer environment. The resin will exhibit suitable corrosion resistance and enhance the structural integrity of the existing manhole.

F. Multi-component stress skin panel coating system.

1. The material applied onto the surface of the manhole shall be a multi-component stress skin panel coating system designed to withstand the effects of hydrogen sulfide without any deterioration to the coating. The coating shall be a solvent free, two-component polymeric, moisture/chemical barrier specifically developed for the wastewater environment.
2. The cured epoxy resin system shall conform to the following minimum Structural Standards:

Table 02775-1
Minimum Structural Standards

Cured Product	Test Method	Results
Tensile Stress	ASTM D-638	7,000-psi
Flexural Stress	ASTM D-790	13,000-psi
Flexural Modulus	ASTM D-790	500,000-psi
Compressive Strength	ASTM D-695	13,000-psi

PART 3 - EXECUTION

3.01 REHABILITATION OF MANHOLE STRUCTURE

A. General Procedures

1. Safety: The Contractor shall perform all work in strict accordance with all applicable OSHA, state, local, and manufacturer’s safety standards. Each method of manhole rehabilitation in this Section requires some degree of manhole entry by workers. Particular attention is drawn to those safety requirements regarding confined space entry and respiratory protection from airborne particulate materials during cleaning, product mixing, and application.
2. Cleaning: All concrete and masonry surfaces to be rehabilitated shall be clean. All grease, oil, laitance, coatings, loose bricks, mortar, unsound brick or concrete, and other foreign materials shall be completely removed. Water blasting utilizing a 210°F steam unit and proper nozzles shall be the primary method of cleaning; however, other methods such as wet or dry sandblasting, acid wash, concrete cleaners, degreasers, or mechanical means may be required to properly clean the surface. All surfaces on which these methods are used shall be thoroughly rinsed, scrubbed, and neutralized to remove cleaning agents and their reactant products. Debris resulting from cleaning shall be removed from the manhole and not discharged downstream.
3. Stopping Infiltration: After surface preparation and prior to the application of mortars and coatings, infiltration shall be stopped either by plugging with a waterstop compound or chemical grout sealing.
4. Patching: All large holes or voids around joints, or pipes and all spalled areas and all holes caused by missing or cracked brick shall be patched. All missing mortar shall be repointed using a non-shrink patching mortar. All cracked or disintegrated material shall be removed from the area to be patched or repointed, exposing a sound sub base. All cracks not subject to movement and greater than 1/16-inch in width shall be routed out to a minimum width and depth of 1/2-inch and patched with non-shrink patching mortar.

5. Flow Control: The Contractor shall be responsible for plugging or diverting the flow of sewage as needed for repair and coating of manhole inverts and benches.
6. Remove all loose grout and rubble from existing channel. Rebuild channel if required by reshaping and repairing slope of shelves or benches. Work shall include aligning inflow and outflow ports in such a manner as to prevent the deposition of solids at the transition point. All inverts shall follow the grades of the pipe entering the manhole. Changes in direction of the sewer and entering branch or branches shall have a true curve with the largest possible radius and shall be shaped to allow easy entrance of maintenance equipment including buckets or T.V. camera.
7. Each coating system shall be installed in accordance with the manufacturer's recommendation to withstand groundwater pressures. For manholes greater than 12-feet in depth, the coating shall withstand the pressures associated with a groundwater depth equal to the manhole depth. Coatings for all other manholes shall withstand the pressures associated with groundwater depth of 12-feet. Measure groundwater depth from manhole bench to top of ground surface.
8. Application of products shall be by factory certified applicators.

3.02 SPRAY APPLIED LIGHT-WEIGHT STRUCTURAL REINFORCED CEMENT

- A. The surface prior to spraying shall be damp without noticeable free water droplets or running water. Materials shall be spray-applied to a minimum uniform thickness to insure that all cracks, crevices, and voids are filled and a somewhat smooth surface remains after light troweling. The light troweling is performed to compact the material into voids and to set the bond.
- B. The first application shall have begun to take an initial set (disappearance of surface sheen, which could be 15-minutes to 1-hour depending upon ambient conditions) before the second application to assure a minimum total finished thickness of 1/2-inch. The final finished thickness may need to be greater than 1/2-inch as recommended by the manufacturer to withstand groundwater pressures. A depth gauge shall be used during application, at various locations, to verify the required thickness. The surface then shall be trowelled to smooth finish with care taken not to over trowel so as to bring additional water to the surface and weaken it. Manufacturer's recommendations shall be followed whenever more than 24-hours have elapsed between applications.
- C. The bench covers used to catch debris shall be removed and the bench and invert sprayed such that a gradual slope is produced from the walls to the invert with the thickness at the edge of the invert being no less than 1/2-inch. The wall-bench intersection shall be rounded to a uniform radius the full circumference of the intersection.
- D. No application shall be made to frozen surfaces or if freezing is expected to occur within the manhole for 24-hours after application. If ambient temperatures are in excess of 95°F, precautions shall be taken to keep the mix temperature at time of application below 90°F, using ice if necessary.
- E. The final application shall have a minimum of 4-hours cure time before being subjected to active flow.

3.03 CENTRIFUGALLY CAST STRUCTURAL REINFORCED CEMENT

- A. Application procedures shall conform to the recommendations of the manufacturer.
- B. The rotating casting applicator shall be positioned to evenly apply the material and be withdrawn at a rate to assure a final minimum thickness of 1-inch. The final finished thickness may need to be greater than 1-inch as recommended by the manufacturer to withstand groundwater pressures. A depth gauge shall be used during application, at various locations to verify the required thickness.
- C. The bench covers used to catch debris shall be removed and the bench and invert sprayed or hand applied so that a gradual slope is produced from the walls to the invert with the thickness at the edge of the invert being no less than 1/2-inch. The wall-bench intersection shall be rounded to a uniform radius the full circumference of the intersection.
- D. No application shall be made to frozen surfaces or if freezing is expected to occur within the manhole for 24-hours after application. If ambient temperatures are in excess of 95°F, precautions shall be taken to keep the mix temperature at time of application below 90°F.
- E. The final application shall have a minimum of 1-hour cure time as recommended by the manufacturer before being subjected to active flow.

3.04 SPRAYED APPLIED EPOXY RESIN SYSTEM

- A. Application procedures shall conform to the recommendations of the manufacturer.
- B. The epoxy resin shall be sprayed onto the surfaces of the manhole walls, benches, and inverts to produce a smooth coating and yield the required structural integrity and corrosion resistance. A depth gauge shall be used during application at various locations to verify the required thickness.
- C. The epoxy resin shall be applied to a minimum thickness of 0.125-inches (125-mils) at the top of the manhole and gradually thickened in accordance with manufacturer's recommendations to withstand groundwater pressures. The application shall have a minimum cure time as recommended by the manufacturer before being subjected to active flow.
- D. The sloped surface of the manhole bench shall be made non-skid by broadcasting aluminum oxide or sand into the surface prior to gelatin/set.

3.05 MULTI-COMPONENT COATING SYSTEM

- A. Application procedures shall conform to the recommendations of the manufacturer.

- B. The coating system shall be sprayed onto the surfaces of the manhole walls, benches, and inverts to produce a smooth surface. The spray equipment shall be specifically designed to accurately ratio and apply the coating system.
- C. Final installation shall be a minimum of 500-mils.
- D. The application shall have a minimum cure time as recommended by the manufacturer before being subjected to active flow.

3.06 SANITARY SEWER LATERAL CONNECTIONS TO MANHOLES

- A. Sanitary sewer lateral connections to rehabilitated manholes shall be reinstated to provide a seamless, leak free, and unobstructed flow connection between the new manhole lining or coating system and the lateral connection per 3.01A.
- B. Sanitary sewer laterals requiring rehabilitation shall be renewed per Section 02772 "Cured-In-Place Pipe (CIPP) For Lateral Renewal."

3.07 MANHOLE REHABILITATION ACCEPTANCE

- A. Test all rehabilitated manholes using the vacuum test method as per ASTM C 1244 "Standard Test Method for Concrete Sewer Manholes by the Negative Air Pressure (Vacuum) Test", following the manufacturer's recommendations for proper and safe procedures. Vacuum testing of manholes and structures shall be performed after curing of coatings. Any visible leakage in the manhole or structure before, during, or after the test shall be repaired regardless of the test results.
- B. All pipes for vacuum testing entering the manhole shall be installed at the top access point of the manhole. A vacuum of 10-inches of mercury (5.0-psi) shall be drawn on the manhole, and the time shall be measured for the vacuum to drop to 9-inches of mercury (4.5-psi). Manholes will be considered to have failed the air test if the time to drop 1-inch of mercury is less than what is shown in the following table:

**Table 02775-2
Vacuum Test Timetable**

Vacuum Test Timetable				
Manhole Diameter – Inches				
Depth – feet	48-inches	60-inches	72-inches	96-inches
4	30 sec.	30 sec.	30 sec.	30 sec.
8	30 sec.	30 sec.	32 sec.	38 sec.
12	30 sec.	39 sec.	48 sec.	57 sec.
16	40 sec.	52 sec.	64 sec.	76 sec.
20	50 sec.	65 sec.	80 sec.	95 sec.
24	60 sec.	78 sec.	96 sec.	114 sec.
+ Each 2'	+5 sec.	+6.5 sec.	+8.0 sec.	+9.5 sec.

- C. Manhole depths shall be rounded to the nearest foot. Intermediate values shall be interpolated. For depths above 24-feet, add the values listed in the last line of the table for each 2-feet of additional depth.
- D. If the manhole or structure fails the vacuum test, the Contractor shall perform additional repairs and repeat the test procedures until satisfactory results are obtained.
- E. After the manhole rehabilitation work has been completed, the manhole shall be inspected by the Contractor in the presence of the County and the work shall be accepted if found satisfactory to the County. No evidence of visible leaks shall be allowed. Non-uniformity, sagging, lamination, holidays or other defects will be cause for rejection of the coating. All surfaces shall be tested for the presence of holidays and pinholes via spark testing at 100-volts per millimeter. The Contractor shall provide the testing equipment and perform the testing in the presence of the County. Any holidays or pinholes found during the testing shall be repaired and the surface re-tested until the surfaces are completely free of holidays and pinholes.

3.08 CLEANUP

- A. After the installation work has been completed and the testing is acceptable, the Contractor shall clean up the entire project area. The Contractor shall dispose of all excess material and debris. The work area shall be left in a condition equal to or better than the prior condition.

3.09 WARRANTY

- A. The Contractor shall guarantee his work for a warranty period of 1-year from the date of acceptance.
- B. If at anytime during the warranty period any leakage, cracking, loss of bond, or other discontinuity is identified, the Contractor shall remove and replace the manhole coating with new material at no cost to the County. No field repair shall be approved.
- C. Furnish an extended warranty for manhole rehabilitation materials from the Contractor and coating manufacturer for a total of 5-years from date of final completion.

END OF SECTION

SECTION 02784
CHAIN LINK FENCES AND GATES

PART 1 - GENERAL

1.01 DESCRIPTION

- A. Scope of Work: This section specifies aluminum coated steel chain link fence, nominally 6-feet high, complete with gates to be constructed around the area indicated on the Drawings.

1.02 QUALITY ASSURANCE

- A. Chain link fences and gates shall be constructed in accordance with specified standards, as well as all pertinent codes and regulations. Where provisions of pertinent codes conflict with the specifications, the more stringent provisions shall govern.
- B. Chain link fences and gates shall be manufactured by established, reputable manufacturers that have been engaged in the manufacture of chain link fencing for at least 10-years.

1.03 SHOP DRAWINGS AND SUBMITTALS

- A. Submittals shall be submitted to the County for review and acceptance prior to construction in accordance with the General Conditions and specifications Section 01300 "Submittals."
- B. The Contractor shall submit layout drawings of all fence and gate installations along with details and manufacturer's literature of all fence and gate materials in the Project.
- C. The Contractor shall submit all motor data, connection diagrams, wiring diagrams, and O&M instructions for all gate operators in the Project.

PART 2 - PRODUCTS

2.01 GENERAL

- A. All material supplied shall be one of the products specified in Appendix D "List of Approved Products" appended to these technical specifications.

2.02 MATERIALS

- A. Fabric: The fabric shall be aluminum coated steel chain link, 72-inches high, No. 9-gauge wire woven in a 2-inch mesh. The fabric shall conform to the requirements of ASTM Designation A491. The aluminum coating shall be a minimum of 0.40-ounces per square foot of wire surface for No. 9-gauge fabric. The fabric shall have a minimum tensile strength of 75,000-psi. The weight of the coating shall be determined by the strip test as defined in ASTM Designation A428. The fabric shall be coated with an ultra violet stable black PVC coating which meets ASTM standards F688 Class I.
- B. Post and Other Appurtenances: All posts and other appurtenances used in the construction of this fence shall be hot dipped galvanized with a minimum of 1.8-ounces per square foot of surface. Pipe sections shall conform to the requirements of ASTM Designation A120. All posts, rails, and fittings shall be coated with an ultra violet stable black PVC coating which meets ASTM standards F688 Class I.
- C. Sizes of Posts, Gate Frames, and Rails:

COMPONENT	DIMENSIONS	
	Nominal Diameter	NPS Pipe Schedule
1. End, corner & pull posts	3-inch	40
2. Gateposts (one leaf width 8-feet or less)	3-inch	40
3. Intermediate posts	2-3/8-inch	40
4. Gate Frames	1-5/8-inch	40
5. Braces	1-5/8-inch	40
6. Top Rails	1-5/8-inch	20

D. Gates

1. Swing Gates: Gates shall be complete with latches, stops, keepers, and hinges. Gate frames shall be constructed of round tubular members continuously welded at all corners or assembled with fittings. Welds shall be painted with aluminum or zinc based paint prior to application of PVC coating. Gate filler shall be of the same fabric as specified for the fence and shall be attached securely to the gate frame with No. 9 tie wires at intervals not exceeding 12-inches. Hinges shall be of adequate strength for the gate and with large bearing surfaces for clamping in position. The hinges shall not twist or turn under the action of the gate. The gates shall be easily operable by one person. Latches, stops, and keepers for all gates, along with 1-inch stainless steel chain and padlock, shall be provided.
2. Sliding Gates: Sliding gates shall be complete with latches, stops, keepers, rollers, and roller tracks. Gate shall ride on a double wheel carrier. Gateposts shall be 3-inch Sch. 40 and frame shall be 1-5/8-inch Sch. 40. Slide pipe tracks shall be 1-5/8-inch Sch. 40. Safety post (outside of gatepost) shall be 3-inch Sch. 40. Fabric shall match fence.

3. Gate padlocks shall be the County standard, case brass, shackle-case hardened steel, 1-inch links with 12-inch chain, 606 finish and keyed alike when more than one.
- E. Top Rail: The top rail shall be provided with couplings approximately every 20-feet. Couplings are to be the outside sleeve type, at least 6-inches long.
- F. Concrete: Concrete shall have a minimum compressive strength of 2,500-psi at 28-days.
- G. Hardware: Miscellaneous hardware shall be of steel, malleable iron or ductile iron of standard design and conform to the requirements of the Chain Link Fence Manufacturer's Institute. All parts shall be galvanized except ties and clips may be aluminum.
- H. Power Gate Operators: The operators for sliding gates shall be Robot Industries, Inc. Model LSG-100, Venco Model SJH, or acceptable equal units designed for use on cantilever sliding gates. Operator motors shall be 1 horsepower and shall be wound for 208 volt, 3 phase, and 60 Hz power supply. Units shall provide gate speed of not less than 75-feet per minute. Units shall be arranged for ground level mounting on 6-inch concrete pads. A quick disconnect for manual operation with a padlock control shall be provided. The cover for the operator shall be of galvanized steel, and the units shall be provided with electric overload protection.

PART 3 - EXECUTION

3.01 ARRANGEMENT

- A. Posts: Posts shall be uniformly spaced, not to exceed 10-feet on centers. Intermediate posts shall have waterproof tops, which have integrally cast openings through which the top rails shall pass. Terminal posts shall consist of end, corner, and pull posts.
- B. Braces: Braces shall be provided at each gate, corner, pull, and end post.
- C. Top Rails: The top rails shall pass through the line post tops and form a continuous brace from end to end of each stretch of fence. The top rail shall be securely fastened to the terminal posts by heavy pressed steel brace bands and malleable end connections.
- D. Bottom Tension Wire: The bottom tension wire shall be No. 7-gauge aluminum coated spring coil or crimped wire. Minimum weight of aluminum coating shall be 0.40-ounces per square foot of wire surface. The tension wire shall be stretched taut between terminal posts and securely fastened to each intermediate post 2-inches above the finish grade line. Tension wire shall be attached to the fence fabric with aluminum hog rings every 24-inches.
- E. Stretcher Bars: Stretcher bars shall be no less than 3/16-inch by 3/4-inch in cross section and shall have minimum length 2-inches longer than the fabric height. Stretcher bars shall be used for attaching the fabric to all terminal posts by threading through the fabric and being attached to the posts with No. 9-gauge tension bands, or other positive mechanical means, spaced at 24-inch centers. One (1) stretcher bar shall be provided for each gate and end post and 2 for each corner and pull post.

- F. Ties and Clips: Fabric shall be fastened to all intermediate posts with 9-gauge tie wires, spacing not to exceed 12-inches apart. Fabric shall be tied to top rail with 9-gauge tie wires, spacing not to exceed 24-inches on centers.

3.02 INSTALLATION

- A. Post Setting: Line and terminal posts shall be set in holes 12-inches in diameter, 42-inches deep with 36-inch post embedment. After the post has been set and plumbed, the hole shall be filled with concrete. The exposed surface of the concrete shall be crowned to shed water.
- B. Terminal and Gateposts: Terminal and gateposts shall be set as specified above and shall be braced to the nearest post with a galvanized horizontal brace used as a compression member and a galvanized 3/8-inch steel truss rod and turnbuckle used as a tension member.
- C. Fabric: Fabric shall not be stretched until concrete footings have cured a minimum of 3-days. Chain link fabric shall be placed on the side designated by the County and shall be stretched taut approximately 2-inches above finish grade and securely fastened to all posts. Rolls of wire fabric shall be joined by weaving a single strand into the ends of the rolls to form a continuous mesh.

END OF SECTION

SECTION 03100
CONCRETE FORMWORK

PART 1 - GENERAL

1.01 DESCRIPTION

- A. Scope of Work: This Section specifies all labor, materials and equipment necessary for providing and installing formwork for concrete.
- B. Related Work Described Elsewhere:
 - 1. Section 03200 "Concrete Reinforcement"
 - 2. Section 03300 "Cast-in-Place Concrete"
- C. General Design: The Contractor shall be responsible for the design of all formwork and for safety in its construction, use and removal.

1.02 QUALITY ASSURANCE

- A. Qualifications: Formwork shall be constructed in accordance with the specified standards, as well as all pertinent codes and regulations. In cases where requirements of pertinent codes conflict with the requirements of these specifications, the more stringent shall govern.
- B. Standards: Unless otherwise indicated, all materials, workmanship and practices shall conform to the following standards:
 - 1. Standard Building Code
 - 2. ACI 347 "Recommended Practice for Concrete Formwork"
 - 3. Local codes and regulations

1.03 SHOP DRAWINGS AND SUBMITTALS

- A. Submittals shall be submitted to the County/Professional for review and acceptance prior to construction in accordance with the General Conditions and specifications Section 01300 "Submittals."
- B. Materials: Submit manufacturer's literature on form ties, spreaders, corner formers, form coatings and bond breakers.

PART 2 - PRODUCTS

2.01 GENERAL

- A. All material supplied shall be one of the products specified in Appendix D "List of Approved Products" appended to these technical specifications.

2.02 MATERIALS

- A. Form Lumber: Use form lumber when in contact with exposed concrete, conforming to the following or acceptable equivalent.
- B. Lumber: Douglas Fir/Larch No. 2 grade, seasoned, surfaced on four sides.
- C. Plywood: "Plyform", Class I or II, bearing the label of the Douglas Plywood Association. (Minimum 3/4-inch thickness).
- D. Form Ties: Use form ties which do not leave an open hole through the concrete and which permit neat and solid patching at every hole. Use embedded rods with integral waterstops and cones to provide a 1-inch breakback. Wire ties and wood spreaders will not be permitted.
- E. Form Coatings: Form release coating shall be a paraffin base oil or mineral oil coating which effectively prevents absorption of moisture; prevents bonding with concrete; is non-staining to concrete; and leaves the concrete with a paintable surface.
- F. Chamfer Strips: Chamfer strips shall be polyvinyl strips or acceptable equal, designed to be nailed in the forms to provide a 3/4-inch chamfer (unless indicated otherwise) at exposed edges of concrete members.

PART 3 - EXECUTION

3.01 INSTALLATION

- A. Construction of Formwork: Forms shall be sufficiently strong to withstand the pressure resulting from the placement and vibration of concrete and shall be sufficiently rigid to maintain specified tolerances. Forms shall be sufficiently tight to prevent loss of mortar, and shall be adequately braced against lateral, upward or downward movement.
- B. Coating of Forms: Apply form coating to board forms prior to placing reinforcing. Keep form coatings off steel reinforcing, items to be embedded, and previously placed concrete.
- C. Form Erection:
 - 1. Provide a means of holding adjacent edges, ends of panels, and ends of sections tightly together and in accurate alignment so as to prevent the formation of ridges, fins, offsets, or similar surface defects of the finished concrete. Insure that forms may be removed without damage to the surface of the finished concrete.
 - 2. Provide a positive means of adjustment of shores and struts. Insure that all settlement is taken up during concrete placing.
 - 3. Temporary openings shall be provided in wall forms to limit the free fall of concrete to a maximum of 6-feet unless an elephant trunk is used. Such openings shall be located to facilitate placing and consolidation and shall be spaced no more than 8-feet apart. Temporary openings shall also be provided in the bottom of the wall, column forms, and elsewhere as necessary to facilitate cleaning and observation immediately prior to placing.

4. Do not embed any form-tying device or part thereof other than metal in concrete.
5. Form surfaces of concrete members except where placement of the concrete is against the ground. The dimensions of concrete members shown on the Drawings apply to formed surfaces, except where otherwise indicated.

D. Form Reuse: Reuse only forms which maintain a uniform surface texture on exposed concrete surfaces. Apply light sanding between uses to obtain such a uniform texture. Plug unused tie rod holes with corks, shave flush, and sand the concrete surface side of the plug.

E. Removal of Forms

1. Forms and shoring for elevated structural slabs, girders, and/or beams shall remain in place until the concrete has reached a compressive strength equal to the specified 28-day compressive strength as determined by test cylinders. Do not remove supports and re-shore. The following table indicates the minimum allowable time after the last concrete is placed before forms, shoring, and/or bracing may be removed.

Structural Item	Minimum Allowable Time
Bottom side of slabs, girders, beams	When concrete reaches specified 28-day compressive strength
Vertical sides of girders, beams	48-hours
Walls not supporting vertical or horizontal loads	48-hours
Walls supporting vertical or horizontal loads	When concrete reaches specified 28-day compressive strength
Footings, pipe encasements, pipe supports	24-hours

2. Do not remove forms from concrete which has been placed with outside air temperature below 50° F without first determining if the concrete has properly set regardless of the minimum times specified in the table above. Do not apply heavy loading on recently poured concrete. Immediately after forms are removed, the surface of the concrete shall be carefully examined and any irregularities in the surface shall be repaired and finished as specified.

F. Formed Openings: Openings shall be of sufficient size to permit final equipment alignment without deflection or offsets of any kind. Where the items pass through the wall, allow space for packing to ensure watertightness. Provide openings with continuous keyways with waterstops where required. Provide a slight flare to facilitate grouting and the escape of entrained air during grouting. Provide reinforcement as indicated and specified. Reinforcing steel shall be at least 2-inches clear from the opening.

G. Embedded Items: Set anchor bolts and other embedded items accurately and hold securely in position in the forms until the concrete is placed and set. Check all special castings, channels, or other metal parts that are to be embedded in the concrete prior to and again after concrete pour. Check all nailing, blocks, plugs, and strips necessary for the attachment of trim, finish, and similar work prior to concrete pour.

H. Pipes and Wall Spools Cast in Concrete

1. Install wall spools, wall flanges, and wall anchors before placing concrete. Do not weld, tie or otherwise connect the wall spools to the reinforcing steel.
2. Support pipe and fabricated fittings to be encased in concrete on concrete piers or pedestals. Carry concrete supports to firm foundations so that no settlement will be possible during Construction.

I. Form Tolerances

1. Failure of the forms to produce the specified concrete surface tolerance shall be grounds for rejection of the concrete work. Rejected Work shall be repaired or replaced at no cost to the County.
2. The following table indicates tolerances or allowable variations from dimensions or positions of structural concrete work:

	Maximum Tolerance
Sleeves and inserts	+1/4-inch to -1/4-inch
Projected ends of anchors	+1/4-inch to -0.0-inch
Anchor bolt setting	+1/4-inch to -1/4-inch
Finished concrete	+ 1/4-inch to -1/4-inch in 10 feet of length

The planes or axes from which the above tolerances are to be measured shall be as follows:

Sleeves and inserts	Centerline of sleeve or insert
Projected ends of anchors	Plane perpendicular to the end of the anchor as located on the Drawings
Anchor bolt setting	Centerline of anchor bolts
Finished concrete	The concrete surface as located on the Drawings

3. Where equipment is to be installed, comply with manufacturer's tolerances if more stringent than above.

END OF SECTION

SECTION 03200
CONCRETE REINFORCEMENT

PART 1 - GENERAL

1.01 DESCRIPTION

- A. Scope of Work: This Section specifies reinforcing steel and welded wire mesh for cast-in-place or precast concrete structures.
- B. Related Work:
 - 1. Section 03100 "Concrete Formwork"
 - 2. Section 03300 "Cast-in-Place Concrete"
 - 3. Section 03410 "Precast Concrete Structures"

1.02 QUALITY ASSURANCE

- A. Standards: Unless otherwise indicated, all materials, workmanship, and practices shall meet all requirements of the current editions of the following standards:
 - 1. Standard Building Code
 - 2. ACI 318 Building Code Requirements for Reinforced Concrete
 - 3. ACI 315 Details and Detailing of Concrete Reinforcement
 - 4. CRSI Manual of Standard Practice, MSP-2

1.03 SHOP DRAWINGS AND SUBMITTALS

- A. Submittals shall be submitted to the County/Professional for review and acceptance prior to construction in accordance with the General Conditions and specifications Section 01300 "Submittals."
- B. Complete shop drawings shall be submitted for comment, including bar lists and placing drawings. Drawings shall show the type, spacing, and location of metal bar supports, the grade of the reinforcing and the name of the manufacturer. The type of coupler splice devices shall be designated.

PART 2 - PRODUCTS

2.01 GENERAL

- A. All material supplied shall be one of the products specified in Appendix D "List of Approved Products" appended to these technical specifications.

2.02 MATERIALS

- A. Reinforcing Bars: ASTM A615, Grade 60, deformed billet steel bars of a USA manufacturer.
- B. Welded Wire Fabric: ASTM A185, galvanized.
- C. Metal Bar Supports: CRSI MSP-2, Chapter 3, Class 2, Type B, Stainless Steel Protected Bar Supports.
- D. Coupler Splice Devices: Cadweld tension couplers capable of developing the ultimate strength of the bar, as manufactured by Erico Products, Incorporated, Solon, Ohio, or equal where acceptable to the County.

2.03 FABRICATION

- A. Fabrication shall meet all requirements of the specified standards. Unless otherwise indicated, the following shall apply:
 - 1. Hooks shall be standard hooks.
 - 2. Bottom bars shall extend a minimum of 6-inches into supporting members.
 - 3. Minimum cover shall be measured to the outermost stirrup, tie or bar.
 - 4. Splices are permitted only where indicated on the Drawings.

PART 3 - EXECUTION

3.01 INSTALLATION

- A. Supporting Reinforcing: Bar supports shall be provided as required by CRSI MSP-2 and AC1315. Top and bottom bars in slabs formed on earth shall be supported on precast concrete block supports except where such bars are properly supported from formwork. Precast concrete block supports are not required in slabs formed on tremie concrete but may be used at the Contractor's option.
- B. Placing Reinforcing: Placing of reinforcing steel and welded wire fabric shall conform to CRSI MSP-2, ACI 315, and the Drawings. Reinforcing shall be securely tied and supported to prevent displacement during concrete placement.
- C. Welded Wire Fabric: Splices in welded wire fabric shall be such that the overlap between outermost cross wires of each fabric sheet is not less than the spacing of the cross wires, plus 2-inches. Fabric shall not be extended through expansion joints or construction joints in slabs on grade except as otherwise indicated on the Drawings.
- D. Coupler Splice: Unless indicated on the Drawings or where conventional lap splices cannot be achieved, full positive tension connections shall be provided. Such devices shall be installed in accordance with the recommendations of the manufacturer.

- E. Dowels: Dowels shall be wired in position prior to placing concrete.
- F. Field Bending: Heat shall not be used to bend bars. Bars shall not be bent after being embedded in concrete.
- G. Welding: Welding of reinforcing will not be permitted.
- H. Place reinforcement a minimum of 2-inches clear of any metal pipe or fittings.

END OF SECTION

THIS PAGE LEFT BLANK INTENTIONALLY

SECTION 03300
CAST-IN-PLACE CONCRETE

PART 1 - GENERAL

1.01 DESCRIPTION

- A. Scope of Work: This Section specifies cast-in-place concrete including all materials, mixing and transport, and performing all labor for the proportioning, mixing, transporting, placing, consolidating, finishing, and curing of concrete.
- B. Related Work Described Elsewhere:
 - 1. Section 03100 "Concrete Formwork"
 - 2. Section 03200 "Concrete Reinforcement"

1.02 QUALITY ASSURANCE

- A. Standards: Unless otherwise indicated, all materials, workmanship and practices shall conform to the requirements of the following standards:
 - 1. Standard Building Code
 - 2. Local Codes and Regulations
 - 3. ACI 318-83, Building Code Requirements for Reinforced Concrete
- B. Plant Qualification: Plant equipment and facilities shall meet all requirements of the checklist for Certification of Ready Mixed Concrete Production Facilities of the National Ready Mixed Concrete Association and ASTM C 94.
- C. Evaluation and Acceptance of Concrete: Evaluation and acceptance of concrete will be in accordance with ACI-318, Chapter 4.

1.03 SHOP DRAWINGS AND SUBMITTALS

- A. Submittals shall be submitted to the County for review and acceptance prior to construction in accordance with the General Conditions and specifications Section 01300 "Submittals."
- B. Materials and Shop Drawings: The following information shall be submitted for review. No concrete shall be furnished until the County has reviewed submittal and no exceptions taken or other favorable response has been returned.
 - 1. Plant Qualification: Satisfactory evidence shall be submitted indicating that the plant and operators have sufficient experience in providing the applicable design mix.

2. Materials: Satisfactory evidence shall be submitted indicating those materials to be used (including cement, aggregates and admixtures) meet the specified requirements.
3. Design Mix: The design mix to be used shall be prepared by qualified persons and submitted for review. Submit affidavit as to design mix performance over the preceding 6-months. The design of the mix is the responsibility of the Contractor subject to the limitations of the Specifications. Acceptance of this submission will be required only as minimum requirements of the Specifications have been met. Such acceptance will in no way alter the responsibility of the Contractor to furnish concrete meeting the requirements of the Specifications relative to strength and slump.
4. Ready Mix Concrete: Provide delivery tickets or weigh master's certificate per ASTM C 94, including weights of cement and each size aggregate, amount of water in the aggregate, and amount of water added at the plant. The amount of water added on the job shall be written on the ticket.

PART 2 - PRODUCTS

2.01 GENERAL

- A. All material supplied shall be one of the products specified in Appendix D "List of Approved Products" appended to these technical specifications.

2.02 MATERIALS

A. Cement

1. Cement for all concrete shall be domestic Portland cement that conforms to the requirements of ASTM Designation C 150 Type I, Type II or Type III. All sanitary sewer manholes, wetwells, pumping stations, tanks and structures exposed to wastewater shall be constructed with Type II cement. Type III cement for high early strength concrete shall be used only for special locations and only with the review and acceptance of the County. Type I cement may be used for buildings and tremie concrete.
2. Only 1 brand of cement shall be used in any individual structure unless acceptable by the County. Cement that has become damaged, partially set, lumpy or caked shall not be used and the entire contents of the sack or container that contains such cement will be rejected. No salvaged or reclaimed cement shall be used.
3. Fly ash shall not be used in either Class A or Class B concrete.

B. Aggregates:

1. ASTM C 33. Coarse aggregates shall be size No. 57. Block cell fill shall be size No. 89.
2. In addition to requirements of ASTM C 33 for structures exposed to wastewater, the following shall apply:
 - a. Soft particles: 2% (2.0 percent)
 - b. Chert as a soft impurity (defined in Table 3 of ASTM C 33): 1% (1.0 percent)
 - c. Total of soft particles and chert as a soft impurity: 2% (2.0 percent)
 - d. Flat and elongated particles (long dimension > 5 times short dimension): 15%.

- C. Water: Clean and free from injurious amounts of deleterious materials.
- D. Air Entraining Admixture: ASTM C 260.
- E. Water Reducing and Retarding Admixture: ASTM C 494, Type D. Admixture shall not contain calcium chloride.
- F. Epoxy Bonding Agent: Sikastix 370, Sikadur Hi Mod, Concrevice 1001-LPL or acceptable equal.
- G. Waterproofing Material: Concrete admixture shall be manufactured and supplied by an approved manufacturer as shown in the Appendix D "List of Approved Products."

2.03 MIXES

A. General Requirements

1. Mix Design: Proportioning shall be on the basis of field experience and/or trial mixtures as specified in ACI 318, Section 4.3. Data on consecutive compression tests and standard deviation shall be submitted. Proportioning for small structures may be by the water/cement ratio under special review and acceptance by the County. Concrete mix design shall comply with the Standard Building Code requirements.
2. Air Content: 5% plus or minus (\pm) 1% (Class A and B).
3. Slump: 4-inches plus or minus (\pm) 1-inch. 8-inches plus or minus (\pm) 1-inch for tremie concrete.
4. Water/cement ratio = 0.45 maximum (all concrete exposed to hydrostatic loading), 0.50 maximum (all other concrete).
5. Minimum Compressive Strength at 28-days
 - a. Class A, 4,000-psi: Water and wastewater structures inclusive of tanks, ditches, pumping stations, tremie concrete and other structures in contact with process water.
 - b. Class B, 3,000-psi: Building structures, curb and gutters, slabs, walks, encasements, thrust blocks, and pipe supports, etc. not in contact with process water.
 - c. Class C, 2,500-psi: Mix wherever specified in the standard drawings such as A103, A112, A303, A406 and A407-2.

B. Production of Concrete

1. General: Concrete shall be ready mixed and shall be batched, mixed and transported in accordance with ASTM C 94, except as otherwise indicated.
2. Air Entraining Admixture: Air entraining admixture shall be charged into the mixture as a solution and shall be measured by means of an acceptable mechanical dispensing device. The liquid shall be considered a part of the mixing water.

3. Waterproofing admixture: New concrete structures shall contain a crystalline waterproofing concrete admixture. Crystalline waterproofing concrete admixture shall be added to the concrete during the batching operation. The admixture concentration shall be added based upon manufacturer design percent concentration of admixture to the required weight of cement. The amount of cement shall remain the same and not be reduced. A colorant shall be added to verify the admixture was added to the concrete for all precast structures. Colorant shall be added and provided at the admixture manufacturing facility, not at the concrete batch plant. It is recommended that the admixture be added first to the rock and sand and blended thoroughly before adding cement and water or per the manufacturer's recommendations. Concrete structures without crystalline waterproofing admixture or admixture without colorant for field verification shall be rejected. Contractor shall provide certification the admixture was installed in accordance with the manufacturer's recommendations.
 4. Water Reducing and Retarding Admixture: Water reducing and retarding admixture shall be added and measured as recommended by the manufacturer. The addition of the admixture shall be completed within 1-minute after addition of water to the cement has been completed, or prior to the beginning of the last 3/4 of the required mixing, whichever occurs first. Admixtures shall be stored, handled and batched in accordance with the recommendations of ACI 68.
- C. Delivery Tickets: In addition to the information required by ASTM C 94, delivery tickets shall indicate the cement content and the water/cement ratio.
- D. Temperatures: The temperature of the concrete upon delivery from the truck shall not exceed 90° F.
- E. Modifications to the Mix: No modifications to the mix shall be made in the plant or on the job which will decrease the cement content or increase the water/cement ratio beyond that specified.

PART 3 - EXECUTION

3.01 PREPARATION

- A. Preparations before Placing: No concrete shall be placed until the review and acceptance of the County has been received. Acceptance will not be granted until forms are clean and reinforcing and all other items required to be set in concrete have been placed and thoroughly secured. The County shall be notified a minimum of 24-hours before concrete is placed.
- B. Conveying:
1. General: Concrete shall be handled from the truck to the place of final deposit as rapidly as practicable by methods which will prevent segregation or loss of ingredients to maintain the quality of the concrete. No concrete shall be placed more than 90-minutes after mixing has begun for that particular batch.

2. Buckets and Hoppers: Buckets and hoppers shall have discharge gates with a clear opening equal to no less than 1/3 of the maximum interior horizontal area, or 5 times the maximum aggregate size being used. Side slopes shall be no less than 60° (degrees). Controls on gates shall permit opening and closing during the discharge cycle.
3. Runways: Extreme care shall be exercised to avoid displacement of reinforcing during the placing of concrete.
4. Elephant Trunks: Hoppers and elephant trunks shall be used to prevent the free fall of concrete of more than 6-feet.
5. Chutes: Chutes shall be metal or metal lined and shall have a slope not exceeding 1 vertical to 2 horizontal and not less than 1 vertical to 3 horizontal. Chutes more than 20-feet long and chutes not meeting the slope requirements may be used only if they discharge into a hopper before distribution.
6. Pumping Equipment: Pumping equipment and procedures shall conform to the recommendations contained in the report of ACI Committee 304 on "Placing Concrete by Pumping Methods," ACI 304.2R-71. The specified slump shall be measured at the point of discharge. The loss of slump in pumping shall not exceed 1-1/2-inches.
7. Conveying equipment Construction: Aluminum or aluminum alloy pipe for tremies or pump lines and chutes, except for short lengths at the truck mixer shall not be permitted.
8. Cleaning: Conveying equipment shall be cleaned at the end of each concrete operation.

3.02 APPLICATION

A. Placing:

1. General: Concrete shall be deposited continuously, or in layers of such thickness (not exceeding 2-feet in depth) that no concrete will be deposited on concrete that has hardened sufficiently to cause the formation of seams or planes of weakness.
2. Supported Elements: At least 2-hours shall elapse after depositing concrete in columns or walls before depositing in beams, girders, or slabs supported thereon.
3. Segregation: Concrete shall be deposited as nearly as practicable in its final position to avoid segregation due to rehandling or flowing. Concrete shall not be subjected to procedures that will cause segregation.
4. Concrete Underwater: All concrete, except that indicated on the Drawings as tremie concrete, shall be placed in the dry.

B. Seals and Tremie Concrete

1. General

- a. Wherever practicable, all foundation excavations shall be dewatered and the concrete deposited in the dry. Where conditions are encountered which render it impracticable to dewater the foundation before placing concrete, a concrete foundation seal shall be placed. The foundation shall then be dewatered, and the balance of the concrete placed in the dry.

- b. When seal concrete is required to be placed, the satisfactory performance of the seal in providing a watertight excavation for placing structural concrete shall be the responsibility of the Contractor. Seal concrete placed by the Contractor, which subsequently fails to perform properly, shall be repaired as necessary to perform its required function, at the expense of the Contractor.
 2. Method of Placing: Concrete deposited underwater shall be carefully placed in the space in which it is to remain by means of a tremie, a closed-bottom dump bucket of not less than 1-cubic yard capacity, or other approved method, and shall not be disturbed after it is deposited. All seal concrete shall be deposited in 1 continuous pour. No concrete shall be placed in running water. All formwork designed to retain concrete underwater shall be watertight, and the design of the formwork and excavation sheeting shall be by a Professional Engineer, registered in the State of Florida.
 3. Use of Tremie: The tremie shall consist of a tube having a minimum inside diameter of 10-inches, and shall be constructed in sections having tight joints. No aluminum parts that have contact with the concrete will be permitted. The discharge end shall be entirely seated at all times, and the tremie tube kept full to the bottom of the hopper. When a batch is dumped into the hopper, the tremie shall be slightly raised (but not out of the concrete at the bottom) until the batch discharges to the bottom of the hopper, after which the flow shall be stopped by lowering the tremie. The means of supporting the tremie shall be such as to permit the free movement of the discharge end over the entire top surface of the Work, and shall permit it being lowered rapidly when necessary to choke off or retard the flow. The flow shall preferably be continuous, and in no case shall be interrupted until the Work is completed. Special care shall be exercised to maintain still water at the point of deposit.
 4. Use of Bottom-dump Bucket: When the concrete is placed by means of a bottom-dump bucket, the bucket shall be lowered gradually and carefully until it rests upon the concrete already placed. The bucket shall then be raised very slowly during the discharge travel; the intent being to maintain, as nearly as possible, still water at the point of discharge and to avoid agitating the mixture. Aluminum buckets will not be permitted.
 5. Time of Beginning Pumping: Pumping to dewater a sealed cofferdam shall not commence until the seal has set sufficiently to withstand the hydrostatic pressure, and in no case earlier than 72-hours after placement of the concrete.
- C. Consolidating Concrete:
1. General: Concrete shall be consolidated by means of internal vibrators operated by competent workmen.
 2. Vibrators: Vibrators shall have a minimum head diameter of at least 2-inches, a minimum centrifugal force of 700-pounds and a minimum frequency of 8,000 vibrations per second.
 3. Vibrators for Confined Areas: In confined areas, the specified vibrators shall be supplemented by others having a minimum head diameter of 1-1/2-inches, a minimum centrifugal force of 300-pounds and a minimum frequency of 9,000 vibrations per second.

4. Spare Vibrator: One (1) spare vibrator for each 3 in use shall be kept on the site during all concrete placing operations.
 5. Use of Vibrators: Vibrators shall be inserted and withdrawn at points approximately 18-inches apart. The duration of each insertion shall be from 5 to 15-seconds. Concrete shall not be transported in the forms by means of vibrators.
- D. Protection: Rainwater shall not be allowed to increase the amount of mixing water, or to damage the surface finish. Concrete shall be protected from construction over-loads. Design loads shall not be applied until the specified strength has been attained.

3.03 CONCRETE FINISHING AND CURING

- A. All slabs exposed to view shall receive a steel trowel finish without local depressions or high points and apply a light hair-broom finish. Do not use stiff bristle brooms or brushes. Leave hair-broom lines parallel to the direction of slab drainage.
- B. All other slabs and footings shall receive a smooth steel trowel finish.
- C. All walls of structures or parts of buildings exposed to view shall receive the following:
 1. Repair defective concrete, remove fins, fill depressions 1/4-inch or deeper, and fill tie holes.
 2. Any surface not receiving a special applied finish, shall receive a slurry finish consisting of 1 part cement and 1-1/2 parts sand by damp loose volume. Dampen surfaces and then apply the slurry with clean burlap pads or sponge rubber floats. Remove any surplus by scraping and then rubbing with clean burlap.
 3. Surfaces that will receive a special applied finish shall be of even color, have no pits, pockets, holes, or sharp changes of surface elevation. Scrubbing with a stiff bristle fiber brush shall produce no dusting or dislodging of cement or sand.
- D. All concrete shall be wet cured a minimum of 7-days; or if not to receive special finishes, coatings or concrete toppings, an acceptable curing compound may be utilized.
- E. All surface defects shall be repaired by removing defective concrete down to sound concrete and repairing with patching mortar. Finished repair shall match adjacent concrete and be cured as specified.

3.04 TESTING

- A. A testing laboratory, acceptable by the County, shall perform required testing. The Contractor shall pay for all tests indicating a failure to comply with the Specifications. The Contractor shall keep the laboratory informed of his schedule.

- B. Standard laboratory compressive test cylinders shall be obtained by the laboratory when concrete is discharged at the point of placing (i.e., discharge end of pumping equipment), and cylinders shall be made and cured in accordance with the requirements of ASTM Designation C 31. A set of 4 cylinders shall be obtained for each 50-cubic yards, or fraction thereof, placed each day for each type of concrete. The cylinders shall be cured under laboratory conditions and shall be tested at 7 and 28-days of age in accordance with the requirements of ASTM Designation C 39.

- C. The testing laboratory shall make slump tests of Class A and Class B concrete as it is discharged from the mixer at the point of placing. Slump tests shall be made for each 25-cubic yards or "pour" of concrete placed. Slump tests may be made on any batch, and failure to meet specified slump requirements shall be sufficient cause for rejection of that batch.

END OF SECTION

SECTION 03410
PRECAST CONCRETE STRUCTURES

PART 1 - GENERAL

1.01 DESCRIPTION

- A. Scope of Work: This Section specifies the materials, labor and equipment required to construct manholes, wetwells, valve vaults, mitered end sections, meter boxes and all other precast concrete structures, as shown on the Drawings and as specified herein.

1.02 QUALITY ASSURANCE

- A. Standards: Unless otherwise indicated, all materials, workmanship and practices shall conform to the following standards.
 - 1. Standard Building Code
 - 2. Local Codes and Regulations
 - 3. ACI Building Code Requirements for Reinforced Concrete
 - 4. American Society for Testing and Materials (ASTM)
 - 5. American Concrete Institute (ACI)
- B. The forms, dimensions, concrete, and construction methods shall be acceptable to the County in advance of construction.

1.03 SHOP DRAWINGS AND SUBMITTALS

- A. Submittals shall be submitted to the County for review and acceptance prior to construction in accordance with the General Conditions and specifications Section 01300 "Submittals."
- B. The Contractor shall submit Shop Drawings to the County, showing all details of construction, reinforcing and joints.
- C. Submit manufacturer's data on certifications and testing for concrete waterproofing additive, joint mastic, gaskets and grout material to be used.

1.04 INSPECTION

- A. The quality of all materials, the process of manufacture, and the finished sections shall be subject to inspection and acceptance by the County. Such inspection may be made at the place of manufacture or at the site after delivery, or at both places, and the sections shall be subject to rejection at any time due to failure to meet any of the specification requirements; even though sample sections may have been acceptable as satisfactory at the place of manufacture. Sections rejected after delivery to the job shall be marked for identification and shall be removed from the job at once. All damaged sections will be rejected. If damaged sections have already been installed; they shall be acceptably repaired if authorized by the County, or removed and replaced at the Contractor's expense.
- B. At the time of inspection, the sections will be carefully examined for compliance with the ASTM designation specified and the acceptable manufacturer's drawings. All sections shall be inspected for general appearance, dimension, "scratch strength", blisters, cracks, roughness, and soundness. The surface shall be dense and close textured.
- C. Imperfections may be repaired subject to the review and acceptance of the County after demonstration by the manufacturer that strong and permanent repairs result. Repairs shall be carefully inspected before final review and acceptance. Cement mortar used for repairs shall have a minimum compressive strength of 4,000-psi at the end of 7-days and 5,000-psi at the end of 28-days, when tested in 3-inch by 6-inch cylinders stored in the standard manner. Epoxy mortar may be utilized for repairs subject to the review and acceptance of the County.

PART 2 - PRODUCTS

2.01 GENERAL

- A. All material supplied shall be one of the products specified in Appendix D "List of Approved Products" appended to these technical specifications.

2.02 PRECAST CONCRETE SECTIONS

- A. Precast concrete wetwell sections, manhole barrel and eccentric top sections shall conform to specifications for precast reinforced concrete manhole sections, ASTM Designation C478, except as otherwise specified below or as shown on the Drawings. Details of precast sections shown on the Drawings, including thickness and reinforcing, shall supersede ASTM C-478 when such details are more stringent than ASTM C-478. The method of construction shall conform to the detailed Drawings appended to these specifications and the following additional requirements:
 - 1. The minimum wall thickness for the various size barrel sections shall be 5-inches, or as indicated in the Drawings.
 - 2. Barrel sections shall have tongue and groove joints. Joints shall be sealed with cold adhesive preformed plastic gaskets set in double rows on the tongue and in the groove prior to setting the next section. Gaskets shall be K.T. Snyder "Ram-Nek", Conseal "CS-102" or acceptable equal. All extension joints shall be sealed with Portland Type II cement after setting of gasket and placement of manhole section into a watertight joint.

3. Type II cement shall be used except as otherwise accepted.
4. New concrete structures shall contain a crystalline waterproofing concrete admix for all new concrete structures including but not limited to manholes, ARV vaults, wetwells, and wetwell top slabs. Crystalline waterproofing concrete admix shall be added to the concrete during the batching operation. Admixture concentration shall be added based upon manufacturer's design percent concentration of admixture to the required weight of cement. The amount of cement shall remain the same and not be reduced. A colorant shall be added to verify the admixture was added to the concrete. Colorant shall be added and provided at the admixture manufacturing facility, not at the concrete batch plant. It is recommended that the admixture be added first to the rock and sand and blended thoroughly before adding cement and water or per the manufacturer's recommendations. Concrete structures without crystalline waterproofing admixture or admixture without colorant for field verification shall be rejected. Contractor shall provide certification from the pre-caster that the admixture was added in accordance with the manufacturer's recommendations. Concrete admixture shall be manufactured and supplied by an approved manufacturer as shown in Appendix D "List of Approved Products."
5. The date of manufacture and the name or trademark of the manufacturer shall be clearly marked on the inside of each precast section. Each section must be inspected and stamped by an accredited testing laboratory.
6. Sections shall be cured by an acceptable method for at least 28-days.
7. Manhole top sections shall be eccentric except that precast concrete slabs shall be used where cover over the top of the pipe is less than 4-feet for all manholes. Lift rings or non-penetrating lift holes shall be provided for handling precast manhole sections. Non-penetrating lift holes shall be filled with non-shrink grout after installation of the manhole sections.
8. Precast concrete slabs over top section, where required, shall be capable of supporting the overburden plus a live load equivalent to ASHTO H 20 loading.
9. The tops of bases shall be suitably shaped to mate with the adjoining precast section.
10. Precast leveling rings for setting cast iron frames over manholes shall be 2-inch thick and have 1 (one) Number 2 continuous reinforcing steel bar.
11. Concrete surfaces shall have form oil, curing compounds, dust, dirt, and other interfering materials removed by brush sand blasting and shall be fully cured prior to delivery.
12. Interior surfaces of manholes, wetwells and valve vaults shall be lined in accordance with Appendix D "List of Approved Products."
13. Manholes to be installed around existing gravity sewers shall consist of a cast-in-place concrete base slab and precast concrete barrel and top sections; lined per Section 3410 – 2.01.11. The base slab shall be as shown on the Drawings and include a joint which is compatible with the bottom barrel section and acceptable to the County. The bottom barrel section shall include an inverted "U-shaped" slot to allow installation of the section over existing pipes. Flow channels shall be provided within the manholes as shown on the Drawings. Annular space between the existing pipe and slot shall be made watertight with non-shrink grout. Existing pipes shall be removed within the manhole and outlets plugged watertight with non-shrink grout as shown on the Drawings.

14. The manholes shall have an invert channel shaped to correspond with the lower half of the pipe. The top of the shelf shall be at the elevation indicated and shall be sloped to drain toward the flowing through channel. Every effort shall be made by the Contractor to construct watertight structures.

PART 3 - EXECUTION

3.01 INSTALLATION

- A. All manholes and other precast structures shall be set in the dry.
- B. Manholes and other precast structures shall be constructed to the dimensions as shown on the Drawings and as specified herein.
- C. The base structure may be cast-in-place concrete as specified in Division 3. The concrete structure shall be placed on the required crushed stone base as shown in the Drawings over a dry sub base of structural fill that has been compacted to 95% (percent) of the maximum dry density as determined by the modified proctor test, ASTM D1557. The tops of the cast in place bases shall be shaped to mate with the precast barrel section and shall be adjusted in grade so that the top of the dome section is at the correct elevation.
- D. Precast bases conforming to all requirements of ASTM C478 and other requirements for precast sections may be used and shall be set on a sub base as described above.
- E. Precast concrete structure sections shall be set vertically with sections in true alignment with a 1/4-inch maximum tolerance per 5-feet of depth. The outside and inside joint shall be filled with a non-shrink mortar and finished flush with the adjoining surfaces. Allow joints to set for 24-hours before backfilling. Backfilling shall be accomplished bringing the fill up evenly on all sides. If leaks appear in the structures, the inside joints shall be caulked with non-shrink grout to the satisfaction of the County. The Contractor shall install the precast sections in a manner that will result in a watertight joint.
- F. Lift rings or non-penetrating lift holes shall be provided for handling pre-cast manhole sections. Non-penetrating lift holes shall be filled with non-shrink grout after installation.
- G. Where holes must be cut in the precast sections to accommodate pipes, cutting shall be done prior to setting them in place to prevent any subsequent jarring which may loosen the mortar joints.
- H. Cast iron frames shall be placed over precast concrete leveling rings, shimmed and set in cement mortar to the required grade. No more than 3 courses of leveling rings shall be used.

END OF SECTION

SECTION 03600

GROUTING

PART 1 - GENERAL

1.01 DESCRIPTION

- A. Scope of Work: This Section specifies the grouting of the annular space between the host pipe and the new liner and the grouting of the space left void in the abandonment of the existing pipelines and structures. The Work consists of furnishing all labor, equipment and materials, and performing all Work connected with the placement of the cementaceous grout to fill the void.

1.02 QUALITY ASSURANCE

- A. Grouting shall be performed by a crew under the direct supervision of a superintendent that has experience in grouting of this nature.
- B. Storage, mixing, handling and placement shall be in accordance with manufacturer's instructions and specifications.

1.03 SHOP DRAWINGS AND SUBMITTALS

- A. Submittals shall be submitted to the County for review and acceptance prior to construction in accordance with the General Conditions and specifications Section 01300 "Submittals."
- B. In addition, the following shall be submitted to the County for review and acceptance prior to construction.
 - 1. A detailed description of equipment and operational procedures to accomplish the grouting operation.
 - 2. Grout mixture design data, grout mixer type, grout samples, and test data.
 - 3. A detailed description of the grouting time schedule.

PART 2 - PRODUCTS

2.01 GENERAL

- A. All material supplied shall be one of the products specified in Appendix D "List of Approved Products" appended to these technical specifications.

2.02 GROUT MATERIAL

- A. The grout shall be a "flowable fill" consisting of a mixture of Type 1 Portland Cement, Type "F" Flyash (ASTM 618), sand and water.

The following is a suggested trial grout mixture for a 1-cubic yard yield:

Cement: 500-pounds
Fly Ash: 500-pounds
Water: 350-pounds (42-gallons)
Sand: 2,248-pounds
Darex (W.R. Grace): 3-ounces (Air Entrainment Additive or equivalent)

The actual grout mixture to be used shall meet the minimum requirements specified below.

- B. The mixture shall contain a minimum of 500-pounds cement and minimum of 400-pounds flyash per cubic yard of grout.
- C. Samples of the grout mixture when set aside in a standard concrete test mold shall show less than 1% of the mixture height of free water on the surface after standing not less than 12-hours.
- D. One (1) set of 3 (three) 3-inch by 6-inch sample test cubes shall be made for each mix preparation. The minimum 28-day strength shall be no less than 1,000-psi. The minimum required slump is 5-inches. The maximum allowable slump is 9-inches. Slump should be as low as practical to maintain viscosity, proper flow, and still retain the ability to pump.

2.03 EQUIPMENT

- A. All grout shall be mixed with a high shear, high-energy colloidal type mixer to achieve the best uniform density.
- B. The grout shall be pumped with a non-pulsating centrifugal or tri-plex pump.
- C. The mixer shall be capable of continuous mixing. Batch mixing shall not be permitted.

PART 3 - EXECUTION

3.01 GROUTING OF ABANDONED PIPE

- A. Where utility pipes are to remain in place (inactive) they shall be filled with a sand/cement grout as specified herein.
- B. The grouting program shall consist of pumping sand-cement grout with suitable chemical additives at pressures necessary to fill the pipe sections in order to prevent the potential for future collapse.

- C. Grouting of pipes shall be in sections not exceeding 300 linear feet.
- D. Grout shall be placed in a maximum of 3 stages, with the initial stage volume equal to or greater than 50% of the total volume for that section of pipe being grouted. The maximum time wait between grouting stages shall be 24-hours.
- E. For each stage, mix and pump the material in one continuous process so as to avoid partial setting of some grout material during that stage; thus, eliminating voids and possible subsequent surface damage due to cave-ins.
- F. Each section shall be grouted by injecting grout from the lowest point and allowing it to flow toward the highest point to displace water from the annulus and assure complete void-free coverage. Grout shall be placed through tubes installed in the bulkheads at the insertion pits or manholes. Grout tubes shall be at least 2-inch nominal diameter.
- G. After the ends of each section of pipe are exposed, the entire space, not to exceed 300 linear feet end to end, shall be sealed by controlled pumping of grout until it flows from the pipe at the opposite end of the grouting. Grouting shall be carried out until the entire space is filled. The ends of these sections shall be capped and/or plugged.
- H. Grout pressure in the void space is not to exceed 5-psi above maximum hydrostatic groundwater level. An open ended, highpoint tap or equivalent vent must be provided and monitored at the bulkhead opposite to the bulkhead through which grout is injected. This bulkhead will be blocked closed as grout escapes to allow the pressuring of the annular space.

3.02 FIELD QUALITY CONTROL

- A. The quality of the grout, application of the equipment, and installation techniques are the responsibility of the Contractor. The review and acceptance or approval of specific mix design, equipment, or installation procedures shall in no way relieve the Contractor of his obligation to provide the final product as specified herein.
- B. The County may stop the grouting operations at any time if the operation does not comply with these Specifications.

END OF SECTION

THIS PAGE LEFT BLANK INTENTIONALLY

SECTION 05500
MISCELLANEOUS METALS

PART 1 - GENERAL

1.01 SCOPE OF WORK

- A. This section specifies the labor, materials, equipment, and incidentals required and installation of covers, grates, frames, hatches, manhole rungs, catch basin castings, and other miscellaneous metals as shown on the Drawings and specified herein.

1.02 QUALITY ASSURANCE

- A. The work in this section shall be coordinated with the work of other Sections. Verify at the site both the dimensions and work of other trades that adjoin items of work in this Section before fabrication and installation of items herein specified.
- B. Furnish to the pertinent trades all items included under this Section that are to be built into the work of other Sections.
- C. Field measurements shall be taken at the site to verify or supplement indicated dimensions and to insure proper fitting of all items.

1.03 SHOP DRAWINGS AND SAMPLES

- A. Submittals shall be submitted to the County for review and acceptance prior to construction in accordance with the General Conditions and specifications Section 01300 "Submittals."
- B. Submit detail drawings showing sizes of members, method of assembly, anchorage, and connection to other members for all products provided under this section to the County for approval before fabrication.
- C. One (1) product sample of each type of product shall be submitted to the County upon request. Samples shall be submitted for concurrent review with Shop Drawings.

1.04 REFERENCE STANDARDS

A. Unless otherwise specified, materials shall conform to the following:

Structural Steel	ASTM A36
Welded and Seamless Steel Pipe	ASTM A53
Gray Iron Castings	ASTM A48, Class 30
Galvanizing, general	ASTM A123
Galvanizing, hardware	ASTM A153
Galvanizing, assemblies	ASTM A386
Aluminum (Extruded Shapes) 6061 T6 (Alum. alloy)	
Aluminum (Extruded Pipe)	6063 T6 (Alum. alloy)
Aluminum Bar Structural	6061 T6 (Alum. alloy)
Bolts and Nuts ASTM, A307	
Stainless Steel Bolts, Fasteners	AISI, Type 316
Stainless Steel Plate and Sheet, Wire	AISI, Type 316
Welding Rods for Steel	AWS Spec. for Arc Welding

PART 2 - PRODUCTS

2.01 GENERAL

A. All material supplied shall be one of the products specified in Appendix D "List of Approved Products" appended to these technical specifications.

2.02 ANCHORS, BOLTS, AND FASTENING DEVICES

A. Anchors, bolts, and other fastening devices shall be furnished as necessary for installation of the work of this Section.

B. Compound masonry anchors shall be of the type shown or required and shall be Star Slug compounded masonry anchors manufactured by Star Expansion Industries, by Phillips Drill Co., Rahplug, or acceptable equal. Anchors shall be minimum "2-unit" type.

C. The bolts used to attach the various members to the anchors shall be the sizes shown or required. Stainless steel shall be attached to concrete or masonry by means of stainless steel machine bolts and iron or steel shall be attached with steel machine bolts unless otherwise specifically noted.

D. For structural purposes, unless otherwise noted, expansion bolts shall be Wej it "Ankr Tite", Phillips Drill Co. "Wedge Anchors", Hilti "Kwik Bolt", or acceptable equal. When length of bolt is not called for on the Drawings, the length of bolt provided shall be sufficient to place the wedge portion of the bolt a minimum of 1-inch behind the reinforcing steel within the concrete.

- E. Materials for anchor or expansion bolts shall be as noted on the Drawings. If no specific material is listed, hot dipped galvanized steel shall be used. All hardware inside wetwells, manholes, or other wetted areas shall be 316 Stainless Steel.

2.03 ALUMINUM ITEMS

- A. Prefabricated checker plate aluminum hatches shall be Type "JD", or "KD" as manufactured by Bilco Co., equal type by Babcock Davis Associates, Inc.; or acceptable equal, sized as shown. Hatches with any single dimension over 3-feet 6-inches shall be double leaf type. Hatches shall be designed for a live load of 300-pounds per square foot. Hatches shall be watertight.
- B. Check plate aluminum cover plates shall be fabricated to the details shown and installed at the locations shown.
- C. Miscellaneous aluminum shapes and plates shall be fabricated as shown. Angle frames for hatches, beams, grates, etc., shall be furnished complete with welded strap anchors attached. Furnish all miscellaneous aluminum shown but not otherwise detailed. Structural shapes and extruded items shall conform to the detail dimensions or the plans within the tolerances published by the American Aluminum Association.

2.04 STEEL ITEMS

- A. Sleeves shall be steel or cast iron pipe in walls and floors with end joints as shown on the Drawings. All pipe sleeves shall have anchors centered on the circumference as shown.
- B. Miscellaneous steel pipe for sleeves, lifting attachments, and other uses as required shall be Schedule 40 pipe fabricated according to the details as shown on the Drawings.

2.05 CAST IRON ITEMS

- A. Outside pipe clean out frames and covers shall be heavy duty, R 6013 R 6099 series as manufactured by Neenah Foundry Co., or acceptable equal. All outside pipe cleanouts shall be 6-inch diameter.
- B. Trench drain shall be of length shown on the Drawings and shall be heavy duty, cast iron, open grate lid type, Series R 4990 Type A as manufactured by Neenah Foundry Co., or acceptable equal.

- C. Gray iron castings for manhole frames, covers, adjustment rings, and other items shall conform to ASTM A48, Class 30B. Castings shall be true to pattern in form and dimensions and free of pouring faults and other defects which would impair their strength or otherwise make them unfit for the service intended. The seating surfaces between frames and covers shall be machined to fit true. No plugging or filling will be allowed. Lifting or "pick" holes shall be provided, but shall not penetrate the cover. Casting patterns shall conform to those shown or indicated on the Drawings. All manhole frames and covers shall be traffic bearing to meet AASHTO H 20 loadings. Frames shall be suitable for the future addition of a cast iron ring for upward adjustment of top elevation.

PART 3 - EXECUTION

3.01 FABRICATION

- A. All miscellaneous metalwork shall be formed true to detail, with clean, straight, sharply defined profiles and smooth surfaces of uniform color and texture and free from defects impairing strength or durability.
- B. Connections and accessories shall be of sufficient strength to safely withstand stresses and strains to which they will be subjected. Steel accessories and connections to steel or cast iron shall be steel, unless otherwise specified. Threaded connections shall be made so that the threads are concealed by the fitting.
- C. Welded joints shall be rigid and continuously welded or spot-welded as specified or shown. The face of welds shall be dressed flush and smooth. Exposed joints shall be close fitting and jointed where least conspicuous.
- D. Welding of parts shall be in accordance with the Standard Code for Arc and Gas Welding in Building Construction of the AWS and shall only be done where shown, specified, or permitted by the County. All welding shall be done only by welders certified as to their ability to perform welding in accordance with the requirements of the AWS code. Component parts of built up members to be welded shall be adequately supported and clamped or held by other adequate means to hold the parts in proper relation for welding.
- E. Welding of aluminum work shall be on the unexposed side as much as possible in order to prevent pitting or discoloration.
- F. All aluminum finish exposed surfaces, except as specified below, shall have manufacturers' standard mill finish. Aluminum handrails shall be given an anodic oxide treatment in accordance with the Aluminum Association Specification AA C22 A41. A coating of methacrylate lacquer shall be applied to all aluminum before shipment from the factory.

- G. Castings shall be of good quality, strong, tough, even grained, smooth, free from scale, lumps, blisters, sand holes, and defects of any kind which render them unfit for the service for which they are intended. Castings shall be thoroughly cleaned and will be subjected to a hammer inspection in the field by the County. All finished surfaces shown on the Drawings and/or specified shall be machined to a true plane surface and shall be true and seat at all points without rocking. Allowances shall be made in the patterns so that the thickness specified or shown shall not be reduced in obtaining finished surfaces. Castings will not be acceptable if the actual weight is less than 95% (percent) of the theoretical weight computed from the dimensions shown. The Contractor shall provide facilities for weighing castings in the presence of the County showing true weights, certified by the supplier.
- H. All steel finish work shall be thoroughly cleaned of all loose mill scale, rust, and foreign matter before shipment and shall be given 1 shop coat of primer in accordance with Section 09865 "Surface Preparation and Shop Prime Painting." Abrasions in the field shall be touched up with primer immediately after erection. Final painting shall be in accordance with Section 09900 "Painting."
- I. Galvanizing shall be the hot dip zinc process after fabrication. Following all manufacturing operations, all items to be galvanized shall be thoroughly cleaned, pickled, fluxed, and completely immersed in a bath of molten zinc. The resulting coating shall be adherent and shall be the normal coating to be obtained by immersing the items in a bath of molten zinc and allowing them to remain in the bath until their temperature becomes the same as the bath. Coating shall be not less than 2-ounces per square foot of surface.

3.02 INSTALLATION

- A. Install all items furnished except items to be imbedded in concrete or masonry, which shall be installed under Division 3 or Division 4 respectively. Items to be attached to concrete or masonry after such work is completed shall be installed in accordance with the details shown. Fastening to wood plugs in masonry will not be permitted. All dimensions shall be verified at the site before fabrication is started.
- B. All steel surfaces to come in contact with exposed concrete or masonry shall receive a protective coating of an approved heavy bitumastic troweling mastic applied in accordance with the manufacturer's instructions prior to installation.
- C. Where aluminum is embedded in concrete, apply a heavy coat of approved bitumastic troweling mastic in accordance with the manufacturer's instructions prior to installation.
- D. Where aluminum contacts masonry or concrete, provide a 1/32-inch neoprene gasket between the aluminum and the concrete or masonry.
- E. Where aluminum contacts a dissimilar metal, apply a heavy brush coat of zinc chromate primer and provide a 1/32-inch neoprene gasket between the aluminum and the dissimilar metal.

- F. Where aluminum contacts wood, apply 2 coats of aluminum metal and masonry paint to the wood.

END OF SECTION

SECTION 08350
ACCESS HATCH DOORS

PART 1 - GENERAL

1.01 DESCRIPTION

- A. Scope of Work: This Section includes providing all labor, materials and equipment necessary to install the access hatch doors on the wetwell and valve vault as indicated on the Drawings and/or specified herein.

1.02 QUALITY ASSURANCE

- A. Standards: The access doors shall meet the standards of the following:
 - 1. Standard Building Code
 - 2. OSHA Requirements
- B. Manufacturers: Manufacturer shall be selected from one of the specified "Manufacturers" in the Orange County Utilities "List of Materials and Approved Manufacturers" as presented as an Appendix to these technical specifications.

1.03 SHOP DRAWINGS AND SUBMITTALS

- A. Shop Drawings: Shop Drawings shall be submitted to the County for approval. Shop Drawings shall include manufacturer's data sheets showing all materials, connections and other required details to illustrate a complete operating access door. Refer to Division 1, Section 01300 "Submittals" for the specific requirements of the submittal.

1.04 WARRANTY AND GUARANTEES

- A. The manufacturer shall provide lifetime guarantee for the access doors against defects in material and/or workmanship. Refer to Section 01740 "Warranties and Bonds" for requirements.

PART 2 - PRODUCTS

2.01 GENERAL REQUIREMENTS

- A. The access door for the wetwell shall have overall dimensions as shown on the Drawings.

- B. Both the wetwell and the valve vault shall be furnished with an access frame and door(s). Equipment furnished shall include the necessary aluminum access frames, complete with hinged and slide bar equipped doors, stainless steel upper guide holder and level sensor cable holder. Doors shall be of aluminum diamond plate. The wetwell doors shall be sized according to pump manufacturer's recommendations. The access frame and door(s) shall have stainless steel hardware. The valve vault access doors size shall be a minimum of inside to inside wall dimensions with a load rating of 300-pounds per square foot. The support beam for loading rating shall be mounted on the door. Wetwell and valve vault covers shall be permanently embossed "CONFINED SPACE" and painted lettering shall not be acceptable. Each door shall be equipped with a recessed hasp enclosure.
- C. Access hatches over wetwell shall have a non-removable back plate constructed of 1/4-inch floor plate, welded to the frame with holes sized to allow passage of pipe flanges with double modular pipe seal.

PART 3 - EXECUTION

3.01 INSTALLATION

- A. The access hatches and doors shall be installed as recommended by the manufacturer and adjusted for proper operation without binding.
- B. Edges of the aluminum frame that will be in contact with concrete shall be coated with coal tar epoxy prior to casting into the concrete, in accordance with Section 09900 "Painting."

END OF SECTION

SECTION 09901
COATINGS AND LININGS

PART 1 - GENERAL

1.01 SCOPE OF WORK

- A. This specification pertains to the specialty coating and lining of manholes and lift station wet wells and valve vaults. As well as the coating of above ground assets including but not limited to: steel, ductile iron pipe, ductile iron fittings, valves, hydrants, hardware and all appurtenances. Brass, bronze and 316 Stainless Steel shall not be coated.
- B. Precast concrete rehabilitation and new structures: The Work shall include the furnishing and installation of an interior protective lining/coating corrosion protection system including all necessary materials, equipment and tools as required for a complete installation in accordance with the manufacturers recommendations. The completed system shall provide a waterproof, corrosion protection system to prevent any deterioration of concrete surfaces from hydrogen sulfide and other corrosive gases/acids produced by wastewater and to prevent infiltration. To ensure total unit responsibility, all materials and installation thereof shall be furnished by, and coordinated with, 1 supplier/manufacturer.

1.02 QUALITY ASSURANCE

- A. All work shall be proved to be in first class condition and constructed in accordance with the Drawings and specifications. All defects disclosed by tests and inspections shall be remedied immediately by the Contractor at no expense to the County.
- B. Fiberglass liner manufacturers shall certify that the liner has been manufactured, sampled, tested, and inspected in accordance with ASTM D 3753.
- C. Polyethylene liner manufacturers shall certify that the liner has been designed and manufactured in accordance with ASTM F 1759 and these specifications.
- D. Holiday Testing: Each coat shall be holiday tested at the recommended 100-125 volts DC per mil in accordance with the latest edition of the following standards: NACE SP0188-2006, NACE Standard RP0490, ASTM G62

1.03 SHOP DRAWINGS AND SUBMITTALS

- A. Submittals shall be submitted to the County for review and acceptance prior to construction in accordance with the General Conditions and specifications Section 01300 "Submittals."

1.04 COVERAGE

- A. The protective lining/coating corrosion protection shall cover all concrete surfaces within the wetwell or manhole including the adjustment ring area.
- B. Coatings and lining surfaces shall be holiday free and all defects shall be repaired in accordance with the manufacturer's recommendations prior to the next coat being applied.

1.05 REFERENCE STANDARDS

- A. American Society for Testing and Materials (ASTM)
 - 1. ASTM C1244: Standard Test Method for Concrete Sewer Manholes by the Negative Air Pressure (Vacuum) Test Prior to Backfill
 - 2. ASTM D3299: Filament-Wound Glass-Fiber Reinforced Thermoset Resin Corrosion-Resistant Tanks
 - 3. ASTM D3350: Standard Specification for Polyethylene Plastics Pipe and Fittings Materials
 - 4. ASTM D3753: Glass-Fiber-Reinforced Polyester Manholes and Wetwells
 - 5. ASTM D6365: Nondestructive Testing of Geomembrane Seams using the Spark Test.
 - 6. ASTM F1759: Design of High-Density Polyethylene (HDPE) Manholes for Sub-surface Applications
 - 7. ASTM F1869: Measuring Moisture Vapor Emission Rate of Concrete Subfloor Using Anhydrous Calcium Chloride
 - 8. ASTM G62: Standard Test Methods for Holiday Detection in Pipeline Coatings.
- B. NACE INTERNATIONAL (Formerly The National Association of Corrosion Engineers)
 - 1. NACE SP0188-2006 (formerly RP0188): Discontinuity (Holiday) Testing of New Protective Coatings on Conductive Substrates.
 - 2. NACE Standard SP0490-2007 (formerly RP0490): Holiday Detection of Fusion-Bonded Epoxy External Pipeline Coating of 250 to 760 μm (10 to 30-mils).
 - 3. NACE Standard SP0178-2007 (formerly RP0178): Design, Fabrication, and Surface Finish Practices for Tanks and Vessels to Be Lined for Immersion Service

PART 2 - PRODUCTS

2.01 GENERAL

- A. All material supplied shall be one of the products specified in Appendix D "List of Approved Products" appended to these technical specifications.

2.02 HDPE LINERS

- A. The Work shall include the furnishing and installation of an interior protective liner system including all necessary labor, materials, equipment and tools as required for a complete installation. Liner shall be high-density polyethylene (HDPE). This liner shall provide a waterproof, corrosion resistant liner to prevent any deterioration of concrete surfaces from hydrogen sulfide and other corrosive gases/acids produced by wastewater and to prevent infiltration. To ensure total unit responsibility, all materials and installation thereof shall be furnished by, and coordinated with, 1 supplier/manufacturer.
- B. Manhole HDPE Liner shall have a minimum thickness of 2-mm (78-mil) and wetwell HDPE shall have a minimum thickness of 5-mm (195-mil). All HDPE liner sheets shall be extruded with a large number of anchoring studs, a minimum of (420/m², 39/ft²), manufactured during the extrusion process in 1-piece with the sheet so there is no welding and no mechanical finishing work to attach the studs to the sheet. The liner shall have a pull out of 112.5-lbs/anchoring stud. A manufacturer certified fabricator shall custom fit the liner to the formwork in order to protect the concrete surfaces from sewer gases.
- C. All welding shall be performed in accordance with the published directives and procedures of the manufacturer and by welders certified by the manufacturer and documentation shall be provided to the County prior to the Work. Completion of welding will provide a 1-piece monolithic HDPE protective liner system that will provide excellent resistance to hydrogen sulfide attack and will not pull off the wall in the event that infiltration occurs. Flat liner sheet, not anchored, used for overlapping joints, shall have a minimum thickness of 3-mm for manholes or 5-mm for wetwells and shall contain a co-extruded bottom surface layer of conductive polyethylene. Conductive cap strip material shall have a free path from the back side of the sheet to a portion of the concrete surface.
- D. Field welding of the liner at the riser joints shall be completed only after vacuum testing (ASTM C1244) of the new structure has been completed and any concrete joint deficiencies have been rectified. Vacuum testing is not required on rehabilitation of existing structures.
- E. Testing and supervision of the installation and welding shall be performed by qualified staff only and must be checked when completed by visually checking and by Spark Testing all welded joints per ASTM D6365. Holiday testing 20,000 to 35,000 volts. All high voltage discontinuity (spark) testing shall be performed using a Tinker & Rasor model AP/W Holiday Detector or equal.
- F. Penetrations (Forcemain, conduit, etc) shall have an internal boot comprising of minimum of 3/8-inch 316SS band clamp compressing a 2-inch wide neoprene with full circumferential welded boot around each penetration in accordance with the manufacturer's details.

2.03 PREFORMED POLYPROPYLENE (PP) LINERS

- A. The Work shall include the furnishing and installation of an interior protective liner system including all necessary labor, materials, equipment and tools as required for a complete installation. This liner shall provide a waterproof, corrosion resistant liner to prevent any deterioration of concrete surfaces from hydrogen sulfide and other corrosive gases/acids produced by wastewater and to prevent infiltration. To ensure total unit responsibility, all materials and installation thereof shall be furnished by, and coordinated with, 1 supplier/manufacturer.
- B. All joints shall be field welded by hot air extrusion welding with PP welding bead. Field welding of the PP liner at the riser joints shall be completed only after vacuum testing (ASTM C1244) of the new structure has been completed and any concrete joint deficiencies have been rectified. Vacuum testing is not required on rehabilitation of existing structures.
- C. Testing and supervision of the installation and welding shall be performed by qualified staff only and must be checked when completed by visually checking and by Spark Testing all welded joints per ASTM D6365. Holiday testing 20,000 to 35,000 volts. All high voltage discontinuity (spark) testing shall be performed using a Tinker & Rasor model AP/W Holiday Detector or equal.
- D. Penetrations (Forcemain, conduit, etc) shall be gasketed PP pipe bell connectors or PP sleeves for boot type connectors and shall be attached to the PP liner by hot air extrusion welding with PP welding bead in accordance with the manufacturer's details.

2.04 FIBERGLASS LINERS

- A. General: Fiberglass reinforced polyester wetwell and manhole liners shall be manufactured from commercial grade polyester resin or other vinyl ester resin with fiberglass reinforcements. The resin system shall be suitable for atmospheres containing hydrogen sulfide and dilute sulfuric acid, as well as other gases associated with the wastewater collection systems. Fiberglass products shall be manufactured in accordance with National Bureau of Standards, Voluntary Product Standard PS 1569 and ASTM D-3753. All inserts and sleeves for piping shall be in accordance with the liner manufacturer's recommendations and shall result in complete coverage of all pre-cast sections and be capable of passing a spark test. The manufacturer shall have a minimum of 5-years experience in manufacturing products which meet the specified standards and shall provide 3 references to verify the qualifications of the manufacturer.
- B. Materials: Resins shall be a commercial grade unsaturated polyester resin. Reinforcing materials shall be commercial grade "E" type glass in the form of mat, chopped roving, continuous roving, roving fabric or a combination of the above, having a coupling agent that will provide a suitable bond between the glass reinforcement and resin. All materials including resins, glass reinforcement, fillers and additives shall be chemically resistant to hydrogen sulfide gas and the sanitary sewer environment. The combined thickness of the inner surface and the interior layer shall not be less than 0.10-inch. Seams shall be sealed

at the factory with the same glass-resin jointing process.

- C. Fabrication: The exterior surface shall be relatively smooth with no sharp projections and no exposed fibers. The exterior surface shall have a gray Gel-coat coating. The interior surface shall be resin rich with no exposed fibers and shall be free of crazing, delaminations, blisters larger than 1/2-inch diameter, wrinkles of 1/8-inch or greater in depth, resin runs, dry areas, sharp projections, or surface pits greater than 6 per square foot if they are less than 3/4-inch diameter and less than 1/16-inch deep. The exterior surface shall be free of blisters larger than 1/2-inch in diameter. To provide UV protection, the exterior surface shall have a factory applied gray pigment for a minimum thickness of 0.125-inches.
- D. Physical Properties: The fiberglass reinforced wetwell and manhole liner shall be designed for H-20 wheel loading and tested in accordance with ASTM D 3753 8.5 (note 1). The fiberglass reinforced wetwell liner and manholes shall meet the following physical requirements:

	Hoop Direction	Axial Direction
Tensile Strength (psi)	18,000	5,000
Tensile Modulus (psi)	0.6 x 10 ⁶ for MH's 0.8 x 10 ⁶ for Wetwell's	0.7 x 10 ⁶
Flexural Strength (psi)	26,000	4,500
Flexural Modulus (psi)	1.4 x 10 ⁶	0.7 x 10 ⁶
Compressive MH's(psi)	18,000	12,000

- E. Chemical Resistance: When tested in accordance with ASTM D3753 8.7 the log of percent retention of each property after immersion testing when plotted against the log of immersion time and extrapolated to 100,000-hours shall assure retention of at least 50% of the initial properties.
- F. Testing: All tests shall be performed as specified in ASTM D3753 latest edition, Section 8, test method D-790 (note 5) and test method D695. Each completed liner shall be examined for dimensional requirements, hardness and workmanship. All required ASTM D3753 testing shall be completed and records of all testing provided to the County. As a basis of acceptance, the manufacturer shall provide an independent certification which shall consist of a copy of the manufacturer's test report, and be accompanied by a copy of the test results that the liner has been sampled, tested and inspected in accordance with the provisions of this specification and meets all its requirements. The independent certification and manufacturer's test report shall be provided to the County prior to delivery of the Liner.
- G. Fiberglass Reinforced Top: The fiberglass manhole liner top shall be fabricated using fiberglass material as above. Material and installation to meet all physical requirements as above. Top to be attached to wetwell liner pipe with fiberglass layup to comply with ASTM D3299. When reinforcement is necessary for strength, the reinforcement shall be fiberglass channel laminated to the inside of the liner top and shall comply with ASTM D3299. 4,000-psi concrete shall be poured around the entire manhole fiberglass cone section. Lift station top slabs shall be re-poured with HDPE interior liner. Contractor

shall ensure an airtight connect between the Pump Station HDPE lined top slab and interior wetwell liner.

- H. Non-Shrink Grout: Non-shrink grout used in the bench area of manholes and fillet areas of wetwells, or on pipe penetrations shall be 100% calcium aluminate, un-thinned and un-altered, as manufactured by Sewpercoat, Strong-Seal, or an approved equal.
- I. Miscellaneous Materials: Additional items of construction necessary for the complete installation of the fiberglass liner shall conform to specific details on the Drawings and shall be constructed of first-class materials conforming to the applicable portions of these Specifications.

2.05 FERROUS METAL SURFACES (INCLUSIVE OF STEEL AND DIP, HYDRANTS, FITTINGS AND APPURTENANCES)

Cleaning, surface preparation, coating application, and thickness shall be as specified herein and shall meet or exceed the coating manufacturer's recommendations. When the manufacturer's minimum recommendations exceed the specified requirements, Contractor shall comply with the manufacturer's minimum recommendations. All cleaning, surface preparation, coating application, thickness, testing, and coating materials (where available) shall be in accordance with the referenced standards of AWWA, ANSI, NACE, SSPC, NSF, and ASTM. Color-coding shall be Safety Blue, Safety Green and Pantone Purple 522-C for water, wastewater and reclaimed water respectively. Surfaces shall be holiday detected in accordance with ASTM G 62. Areas found to have holidays shall be marked and repaired in accordance with the paint manufacturer's instructions. The County shall be notified of time of testing so that he might be present to witness testing.

- A. Procedures for Coating Exterior of DIP, Hydrants, Fittings and Appurtenances
 - 1. Surface Preparation: Do not abrasive blast or prepare more surface area than can be coated in the same day; prepare surfaces and apply prime coatings within an 8-hour period.
 - a. Steel: Shall require NACE-1/SSPC-SP5 White Metal Blast Cleaning minimum angular anchor profile of 1.5-mils. White metal blast cleaning removes all of the coating, mill scale, rust, oxides, staining, corrosion products, and other foreign matter from the surface.
 - b. DIP: DIP with asphaltic seal coat, Hydrants, FBE (Valves and appurtenances), Shall require NACE-3/SSPC-SP6 Commercial Blast Cleaning minimum angular anchor profile of 1.5-mils. Commercial blast cleaning removes all visible oil, grease, dust, dirt, mill scale, rust, coating, oxides, corrosion products, and other foreign matter from all surfaces and allows stains to remain on 33% (percent) of each unit area of surface.

- c. Note: Primer Option - Hydrants, FBE (Valves and appurtenances), existing factory coatings: Where specifically called out in the Coating System Table below, NACE-4/SSPC-SP7 may be substituted for the commercial blast for hydrants and factory applied FBE (Valves and appurtenances) where the coating manufacturer has specifically provided compatible coatings with existing coatings including urethane, epoxy, alkyd and water-based coatings. Under no circumstances shall DIP with asphaltic seal coat be over-coated. NACE-4/SSPC-SP7 Brush-Off Blast Cleaning shall be free of all visible oil, grease, dirt, dust, loose mill scale, loose rust, and loose coating. Tightly adherent mill scale, rust, and coating may remain on the surface. Mill scale, rust, and coating are considered tightly adherent if they cannot be removed by lifting with a dull putty knife after abrasive blast cleaning has been performed.
2. Contaminants: Remove dirt, dust, oil and all other contaminants that could interfere with adhesion of the coating in accordance with SSPC-SP1 for the substrate and between each coating layer.
3. Temperature: Surface temperature of substrate shall be a minimum of 5°F above the dew point and rising and generally between 40°F to 100°F. Temperatures shall not exceed manufacturer's recommendations.
4. Stripping: Edges, corners, crevices, welds, and bolts shall be given a brush coat/stripe coat for each material/layer. The stripe coat shall be applied by a brush and worked in both directions.
5. Coatings Systems: Two (2) options for coating systems are provided. Each coat shall be a distinctive color or shade to verify each coating in the system.
6. Prime coat: DIP, DIP with asphaltic seal coat, Hydrants, FBE (Valves and appurtenances) prime coat shall be zinc-rich. Zinc-rich shall only be used on bare metal. Factory applied FBE/Asphaltic/Mastic coatings on valves and appurtenances shall be completely removed per NACE 3 / SSPC-SP6.
7. Note: Where specifically called out in the Coating System Table for factory applied FBE (Valves and appurtenances) surface preparation may be NACE-4/SSPC-SP7 and the prime coat shall be an Inorganic water based epoxy. Asphaltic seal coats and mastics shall not be overcoated with Inorganic water based epoxy.
8. Intermediate coat: Varies per coating system.
9. Final Coat: Varies per coating system.
10. Holiday Testing: Each coating layer shall be holiday tested at the recommended 100-125 volts DC per mil in accordance with the latest edition of the following standards: NACE SP0188-2006, NACE Standard RP0490, ASTM G62 and per the manufacturers recommendations. All low voltage holiday testing shall be performed using a Tinker & Razor model M-1 Holiday Detector or equal.
11. Coating Systems: Either System 1 or System 2 shall be used for above ground, non-immersion ferrous metal surfaces (Inclusive of Steel, DIP, Hydrants, Fittings and Appurtenances).

Color Codes

Generic Name	Application	Tnemec	Carboline	PPG / Ameron
Safety Blue	Water Master Meters	True Blue / Safety 11SF	9122	BL Safety Blue
Safety Green	Pump Station Piping	Hunter Green 08SF	V358	GN Safety Green
Pantone Purple 522C	Reclaimed Master Meters	Purple Rain / Safety 14 SF	7528	PL Safety Purple
Safety Green	Hydrant Bonnet & Caps	Hunter Green 08SF	V358	GN Safety Green
Safety Orange	Hydrant Bonnet & Caps	Tangerine Orange / Safety 04 SF	1420	OR 2Safety Orange
Safety Red	Hydrant Bonnet & Caps	Candy Apple Red / Safety 06SF	7573	RD 2 Safety Red
Safety Silver	Hydrant Barrel	Aluminum 57GR	J766	SL Safety Silver

System 1 - Zinc / Urethane / Fluoropolymer

Description	Generic Coating Name	Tnemec	DFT mils	Carboline	DFT mils
Prime Coat all materials. Surface Prep NACE 1 or NACE 3	Zinc-Rich	Zinc Series 90-97	2.5 - 3.5	Carbozinc 621	3.0 - 8.0
Prime Coat - option for FBE or Hydrants only. Surface Prep NACE 4	Inorganic water based epoxy – overcoat existing coatings	Typoxy Series 27WB	4.0 - 14.0	NA	NA
Intermediate Coat.	Aliphatic Acrylic Polyurethane	Endura-Shield Series 73	2.0 - 3.0	Carbothane 133 HB	3.0 - 5.0
Final Coat.	Advanced Thermoset Fluoropolymer Polyurethane	Hydroflon Series 700	2.0 - 3.0	Carboxane 950	2.0- 3.0

System 2 - Zinc / Epoxy / Urethane

Description	Generic Coating Name	Tnemec	DFT mils	Carboline	DFT mils	PPG / Ameron	DFT mils
Prime Coat all materials. Surface Prep NACE 1 or NACE 3	Aromatic Urethane, Zinc-Rich	Zinc Series 90-97	2.5 - 3.5	Carbozinc 621	3.0 - 8.0	Amercoat 68HS	3
Prime Coat option for FBE, Hydrants. Surface Prep NACE 4	Inorganic water based epoxy – overcoat existing coatings	Typoxy Series 27WB	4.0 - 14.0	NA	NA	NA	NA
Intermediate Coat.	Polyamidoamine Epoxy	Color Hi-Build Epoxoline II Series N69	4.0 - 10.0	Carboguard 60	4.0 - 6.0	Amerlock 2/400	4.0 - 6.0
Final Coat.	Aliphatic Acrylic Polyurethane	Endura-Shield Series 73	2.0 - 3.0	Carboxane 950	2.0 - 3.0	Amercoat 450H	2.0 - 3.0

2.06 SPECIALTY COATINGS

- A. The Specialty Coatings are for rehabilitation of existing precast concrete manholes and existing valve vaults. New precast structures shall be lined only. All specialty coatings applicators shall follow the procedure as outlined below:
1. Pre-Inspection: Applicator shall take appropriate action to comply with all local, state and federal regulations including those set forth by OSHA, EPA, the County and any other applicable authorities. Prior to conducting any work, perform inspection of structure to determine need for protection against hazardous gases or oxygen-depleted atmosphere and the need for flow control or flow diversion.
 2. Bypass plan: Bypass plan for flow control or bypass shall be submitted to the County for approval prior to conducting the work. Any active flows shall be dammed, plugged, or diverted as required to ensure all liquids are maintained below or away from the surfaces to be coated until final applications are cured as recommended by the corrosion protection system manufacturer.
 3. Surface Preparation: NACE 6/SSPC-SP13 "Surface Preparation of Concrete." Dry abrasive blasting, wet abrasive blasting, vacuum-assisted abrasive blasting, and centrifugal shot blasting, high pressure water cleaning (5,000 to 10,000-psig), water jetting (10,000 to 30,000-psig) or combination of methods to remove deteriorated concrete, brick or mortar, laitance, hard contaminants, existing coatings, localized micro-organisms and gas contaminants from the concrete walls, floor, ceiling, and other concrete surfaces and shall display a surface profile suitable for application of the system. Minimum surface profile shall be ICRI CSP-5 or greater. Containment shall be provided to capture spent abrasive material and deteriorated concrete for removal by the Contractor.
 4. Substrate Inspection: After completion of surface preparation, the Contractor shall inspect for: Leaks, Cracks, Holes, Exposed Rebar, Ring and Cover Condition, Invert Condition, Inlet and Outlet Pipe Condition. After the defects in the structure have been identified, repair with a manufacturer approved underlayment or material to assure proper rehabilitation of the surface defect and compatibility with the specialty coating system product to be applied. Repairs to exposed rebar, defective pipe penetrations or inverts, shall be recommended by the specialty coating manufacturer and approved by the County prior to proceeding with the repair. Final preparation and cleaning of repaired surfaces is required prior to application of the coating and shall comply with the corrosion protection system manufacturer's recommendations.
 5. Manufacturer's certification: Applicators, installers, welders and application equipment shall be certified by the manufacturer of the corrosion protection system and documentation shall be provided to the County prior to the work.
 6. Area to be coated: All exposed concrete of the entire interior surface of precast structure including but not limited to benching, pipe penetrations, walls, bottom of top slab, chimney, etc. Flow channel inverts are not necessary to coat. Corrosion protection system shall interface with adjoining construction materials/components throughout the manhole structure to effectively seal and protect substrates from attack by corrosive elements and to ensure the effective elimination of infiltration into the sewer system.

7. Application: Application of specialty coating system shall be in strict accordance with manufacturer's recommendation. Specified surfaces should be shielded to avoid exposure of direct sunlight, other intense heat source or, where cementitious products are employed, excessive ventilation. Where varying surface temperatures do exist, coating installation should be scheduled when the temperature is falling versus rising. Verification of the corrosion protection system thickness shall be verified during application via wet gauge methods or following cure of the system using appropriate non-destructive or destructive methods.
 8. Holiday Testing: Cure time shall be in accordance with the Manufacturers product data sheet. Final concrete structure corrosion protection system shall be completely free of holidays, pinholes or voids. High voltage Holiday testing shall be required and holidays marked and repaired with same material and to same thickness as required of original installation. All high voltage discontinuity (spark) testing shall be performed using a Tinker & Rasor model AP/W Holiday Detector or equal and at 100-125 volts DC per mil or per the manufacturers recommendations.
 9. Destructive Testing: Destructive testing may be performed as directed by the County to verify coating adhesion and coating DFT. Repairs to areas tested by destructive means shall be repaired by the certified applicator at the Contractor's expense.
 10. Reporting: Provide final written report to the County detailing the location, date of report, description of repair or original installation and manufacturer data and cut sheets of the corrosion protection system and applicable testing results as per sections 7, 8 and 9.
 11. Warranty: The report shall contain a copy of the warranty.
- B. System SC-1: Sauereisen Sewergard 210 (Trowelable), 210FS (Trowelable Fast Set), 210S (Sprayable) or 210RS (Rotary Spray) shall be applied and then shall be finished with a coat of Sauereisen Sewergard Glaze 210G. The lining system to be utilized shall be an epoxy mortar or aggregate filled epoxy. Material furnished under this specification shall be a pre-packaged from the manufacturer. Materials shall be trowel applied or sprayed and shall conform to the Manufactures product data sheet as supplied by the manufacturer.
1. Additional Preparation: To ensure a good bond, the newly blasted surface shall be thoroughly vacuumed to remove all sand and debris and surface shall be dry prior to application.
 2. Surfacer for Rehabilitation/repair: Substrate in requiring repairs in excess of 1/8-inch shall be repaired with Sauereisen Underlayment No F-120, F-121 or F-209 Filler prior to application of protective lining/coating corrosion protection system.
 3. Thickness:
 - a. Sewergard 210 / 210FS / 210RS: The material shall be applied in 1 or more layers for a total thickness of minimum of 125-mils DFT (1/8-inch). After application, the material shall be damp rolled with excess water shaken off prior to back rolling.
 - b. Sprayable 210S: The material shall be applied in 1 or more layers for a total thickness of minimum of 60-mils shall be required for the Spray applied 210S.
 4. Finishing Glaze: After application, and curing of either the 210, 210FS, 210RS or 210S, the material shall be coated with a minimum of 20-mils of Sauereisen Sewergard Glaze 210G by roller or spray application in accordance with the manufacturers recommendations.

5. Holiday Testing: The protective lining/coating protection system shall be cured in accordance with the manufacturer's recommendations prior to holiday testing at a minimum of 14,500 volts.

C. System SC-2: Tnemec Perma-Shield Coating System.

1. Additional Preparation: To ensure a good bond, the newly blasted surface shall be thoroughly vacuumed to remove all sand and debris and surface shall be dry prior to application and surface shall be minimum 5°F above the dew point. Moisture content not to exceed 3-pounds per 1,000 square feet in a 24-hour period verify dryness using a "plastic film tape-down test" ASTM D4263 and perform Anhydrous Calcium Chloride ASTM F1869.
2. Surfacers for Rehabilitation/repair: Substrate in requiring repairs in excess of 1/8-inch shall be repaired Series 217 or 218 Filler prior to application of protective lining/coating corrosion protection system. Concrete surface shall be pre-wet or dampened with potable water prior to surfacer application.
3. Thickness: Lining Series 434: The material shall be applied in 1 or more layers for a total thickness of minimum of 125-mils DFT (1/8-inch).
4. Finishing Glaze: After application, and curing, the material shall be coated with 15-20-mils of Series 435 in accordance with the manufacturer's recommendations.
5. Holiday Testing: The protective lining/coating protection system shall be cured in accordance with the manufacturer's recommendations prior to holiday testing at a minimum 14,500 volts.

D. System SC-3: Sewercoat (PG and 2000 HS) Calcium aluminate mortar: The coating system to be utilized shall be 100% calcium aluminate cement with 100% calcium aluminate aggregate. Materials shall be spray applied by either a wet gunning (low-pressure spray) or dry gunning (shotcrete) method and shall conform to the manufacturer's product data sheet as supplied by the manufacturer. The equipment shall be clean and free of any hydrated or un-hydrated Portland Cement.

1. Additional Preparation: To ensure a good bond, the newly blasted surface shall be fully saturated with water prior to application.
2. Thickness: The material shall be applied in 1 or more layers to such total thickness as required. A minimum of 1-inch shall be applied.
3. Finishing: After spraying, the material shall be brushed or trowel finished.
4. Curing: Curing by appropriate methods (curing compound, water mist, etc.) should be implemented as the surface begins to harden and dry (as early as 1-hour after application).

E. System SC-4: Raven 405: System shall be 100% solids epoxy. Thinning with solvents shall not be permitted. Surface preparation, mixing, pot life, ambient conditions, application, film thickness per coat, cure time, and recoat time shall be in accordance the manufacturer's recommendations.

1. Applicator/installer shall be certified by the Manufacturer.
2. Surfacers/Repair: Raven 710, 705CA or Raven 700 shall be spray applied or trowelled to repair/fill minor surface defects or applied as an underlayment.

3. Primer: Concrete exhibiting a moisture vapor emission rate greater than 3-lbs/1,000 square feet/24-hours, when tested according to ASTM F1869, shall be primed with Raven 155. Raven 155 primer (2 component waterborne epoxy) shall be applied at a maximum of 8-mil WFT (3-mil DFT). Recoat window minimum 2-4-hours at 72°F with maximum 72-hours at 72°F.
 4. Top Coat: Raven 405 shall be applied with an approved plural component airless spray system. Coating thickness shall be in relation to the profile of the surface to be coated as recommended by the coating product manufacturer. In all cases the coating shall be applied with minimum of 2 coats applied at 40-80-mils WFT/DFT each for minimum final film thickness at 125-mils DFT. Subsequent top coating or additional coats of the coating product(s) shall occur within the product's recoat window: minimum cure to a tacky state; maximum cure of 18-hrs at 72°F substrate temperature. Additional surface preparation procedures will be required if this recoat window is exceeded including inspection for and removal of amine blush and/or other potential contaminants.
 5. Holiday Testing: The protective lining/coating protection system shall be cured in accordance with the manufacturer's recommendations prior to holiday testing at a minimum of 12,500 volts.
- F. SC-5: Spectrashield Multicomponent Coating System. Spectrashield multi-component stress panel liner system composed of moisture barrier (modified polymer), surfaces (polyurethane/polymeric blend foam) and final barrier coat (modified polymer). The system is applied in three-steps and the applicator/installer shall be certified by the Manufacturer.
1. Application
 - a. Moisture barrier: Silicone Modified Polyurea Minimum 40-mils DFT
 - b. Surfacer: Polyurethane/Polymeric blend foam
 - c. Final corrosion barrier: Silicone Modified Polyurea Minimum 60-mils DFT
 2. Film Thickness: Final installation shall be a minimum of 500-mils. A permanent identification and date of work performed shall be affixed to the structure in a readily visible location.
 3. Holiday Testing: The protective lining/coating protection system shall be cured in accordance with the manufacturer's recommendations prior to holiday testing at a minimum of 50,000 volts.

PART 3 - EXECUTION

3.01 QUALITY ASSURANCE

- A. All materials shall be delivered to the job in original sealed and labeled containers of the coating manufacturer, and shall be subject to inspection by the County. Labels shall show name of manufacturer, type of coating, formulation, date, color and manufacturers recommendations. Coatings manufacturer date shall not exceed the manufacturer's recommendations for storage and useful life and Coatings manufactured in excess of 1-year prior to application shall be rejected.

- B. Oil and grease shall be completely removed in accordance with SSPC-SP1 before beginning any other surface preparation method. Surfaces of welds shall be scraped and ground as necessary to remove all slag and weld spatter.
- C. All components of equipment that can be properly prepared and coated after installation shall be installed prior to surface preparation. Components that will be inaccessible after installation shall have the surfaces prepared and coated before installation.
- D. All ferrous metal surfaces shall be free of all defects and have all sharp edges, welds, slag, defects and weld splatter ground smooth in accordance with NACE Standard RPO178.
- E. Edges, corners, crevices, welds, and bolts shall be given a brush coat (stripe coat) for each coating. The stripe coat shall be applied by a brush and worked in both directions. Special attention shall be given to filling all crevices with coating.
- F. Coating shall be applied in a neat manner that will produce an even film of uniform and proper thickness, with finished surfaces free of runs, sags, ridges, laps, and brush marks. Each coat shall be carefully examined and faulty material, poor workmanship, holidays, damaged areas and other imperfections shall be touched up prior to applying succeeding coats. Each coat shall be thoroughly dry and hard before the next coat is applied in accordance with the coating manufacturer's recommendations for drying time between coats. In no case shall coating be applied at a rate of coverage greater than the maximum rate recommended by the coating manufacturer. Each coat shall be uniform in coverage and color. Successive coats shall perceptibly vary in color.
- G. Coating failures will not be accepted and shall be entirely removed down to the substrate and the surface recoated. Failures include but are not limited to holidays, sags, checking, cracking, teardrops, fat edges, fisheyes, or delamination.
- H. Surfaces not required to be coated: Brass, Bronze, Stainless steel (Not including SS bolts and nuts)

3.02 INSPECTION FOR ACCEPTANCE

- A. The quality of materials, the process of manufacture and the finished sections shall be subject to inspection and approval by the County. Such inspection may be made at the place of manufacture, at the site after delivery or at both places and the sections shall be subject to rejection at any time due to failure to meet any of the specification requirements; even though sample sections may have been accepted as satisfactory at the place of manufacture. Sections rejected after delivery to the job shall be marked for identification and shall be removed from the job at once. Sections that have been damaged after delivery will be rejected and if already installed removed and replaced, entirely at the Contractor's expense.

- B. At the time of inspection, the sections will be carefully examined for compliance with the specified ASTM designation and with the approved manufacturer's drawings. Sections shall be inspected for general appearance, dimension, "scratch-strength" blisters, cracks, roughness, soundness, etc. The surface shall be dense and close-textured.
- C. Precast concrete structures shall be inspected by the County and defective materials shall be replaced by the Contractor at the Contractor's expense.
- D. Any repairs made on surfaces shall be holiday detected. Areas found to have holidays shall be marked and repaired in accordance with the coating manufacturer's instructions. The County shall be notified of time of testing so that he might be present to witness testing.

3.03 FIBERGLASS LINER INSTALLATION

- A. Do not drop or impact the fiberglass liner. Use of chains or cables in direct contact with the liner is prohibited.
- B. The Contractor shall sequence the Work so that wastewater service is maintained to existing customers at all times.
- C. The interior of the wetwell shall be pressure washed with an 800 to 1,000-psi water blast, acid washed with a 20% muratic acid solution, and pressure washed a second time. All loose materials, grease/fats, and hydrogen sulfide contamination shall be removed. The existing bench/fillet areas in the wetwell/manhole shall be removed prior to pressure washing. An inspection of the structures shall be conducted by the County prior to the fiberglass liner installation.
- D. Exterior liner diameter shall be approximately 4-inches smaller than the inside diameter of the barrel section of the structure.
- E. Liner depth shall be from invert to top elevation of manhole and wetwell. The top 12-inches of the manhole liner shall be a fiberglass neck that extends from the liner corbel or cone section to the bottom of the ring and cover. The neck is used to protect the concrete grade rings or brick and mortar adjustments from the sewer environment.
- F. The wetwell top slab and manhole corbel or cone section shall be removed and discarded by the Contractor in accordance with all applicable regulations at the Contractor's expense.
- G. Measure and cut wetwell liner to exact length and invert configuration. Measure and cut all incoming and outgoing line openings.
- H. Lower wetwell liner into wetwell and level.
- I. Extend all incoming and outgoing lines inside the liner with PVC or other approved pipe.
- J. The existing concrete bench area of manholes and fillet areas of wetwells shall be removed

completely during initial preparation. Upon installation of the liner, a new bench/fillet shall be constructed with non-shrink grout and shall be field coated with resin and fiberglass in a dry environment after wastewater flows are diverted. The newly constructed bench shall sufficiently overlap the newly installed liner to prevent migration of fluids or gases between the liner and the bench. There shall be no exposed concrete between the factory manufactured fiberglass liner and the field installed fiberglass bench overlay.

- K. Pipe Penetrations: Piping shall extend past the liner into the fiberglass wetwell or flush with the liner. If the existing piping does not fully penetrate the fiberglass liner, the Contractor must extend similar material piping into the fiberglass wetwell. Any gaps on joints must be sealed with a non-shrink grout specified herein.
- L. Pour or pump 3,000-psi pump mix into the annular space between the liner and existing wet well.
- M. Use concrete grade rings on top of the liner cone section to bring ring and cover to finish grade. Manhole liner neck section shall extend from the ring and cover support area up to the ring and cover. The neck section shall be designed to protect the adjustment ring(s), brick and mortar used to bring the ring and cover to final grade
- N. A non-shrinking grout as specified herein shall be applied to areas that cannot be fiberglassed due to water.
- O. Following installation, the Contractor shall determine soundness by applying air or water pressure (3-5-psi) to the wet well or manhole liner. While holding at the established pressure, inspect the entire wetwell and manhole for leaks, based on loss of measured pressure. Any leakage through the laminate is cause for failure of the task. The County shall be present during testing. The Contractor shall be responsible for isolating the work of this Contract from existing work and shall be solely responsible for the method of such isolation. Refer to ASTM D-3753 8.6. Any repairs required shall be repaired in accordance with the manufacturer's recommendations at the Contractor's expense.
- P. Prior to final acceptance and final inspection of the fiberglass liner installation, flush and clean all parts of the system. Remove all accumulated construction debris, rocks, gravel, sand, silt, and other foreign material from the wetwell or manhole

END OF SECTION

THIS PAGE INTENTIONALLY LEFT BLANK

SECTION 09905
PUMP STATION VALVE IDENTIFICATION SYSTEM

PART 1 - GENERAL

1.01 DESCRIPTION

- A. Scope of Work: The work included under this Section consists of providing an identification system for pump station plug and check valves.

1.02 SUBMITTALS

- A. Submit manufacturer's descriptive literature, illustrations, specifications, and other pertinent data in accordance with Section 01300 "Submittals."
- B. Schedules:
1. Provide a typewritten list of all tagged valves giving tag color, shape, letter code and number, the valve size, type, use, and location.
- C. Samples:
1. Provide a sample of each type valve tag supplied.

PART 2 - PRODUCTS

2.01 PUMP STATION VALVE IDENTIFICATION (ABOVE GROUND OR IN VALVE VAULTS)

- A. A coded and numbered tag attached with brass chain and/or brass "S" hooks shall be provided on all valves.
1. Tag Types: Tags for valves on pipe shall be brass or anodized aluminum. Square tags shall be used to indicate normally closed valves and round tags shall indicate normally open valves.
 2. Coding: In addition to the color-coding, each tag shall be stamped or engraved with wording or abbreviations to indicate the valve service and number. All color and letter coding shall be approved by the County. Valve numbering shall be as shown on the Drawings.

PART 3 - EXECUTION (NOT USED)

END OF SECTION

THIS PAGE LEFT BLANK INTENTIONALLY

SECTION 09960
HIGH PERFORMANCE FERROUS METAL COATINGS

PART 1 - GENERAL

1.01 SCOPE OF WORK

- A. The work of this section includes surface preparation, coating systems and methods of application for ferrous metal surfaces. All work shall be done in strict accordance with this specification, the Contract Documents, and the manufacturer's printed instructions.
- B. The Contractor shall furnish all supervision, labor, tools, materials, equipment, maintenance of traffic, containment systems, scaffolding, other structures and incidentals required for transportation, unloading, storage, surface preparation, protection of the public and environment, application of products, and cleanup necessary to complete this Contract in its entirety.
- C. The scope of Work includes painting all exposed miscellaneous metal, pipe, fittings, valves, hangers, straps, support, hardware, equipment, appurtenances, and all other work obviously required to be painted unless otherwise specified. The Contractor shall also paint all surfaces he affects or damages during his performance of the Work, which may be exposed to view in the finished work including, but not limited to, metals, pipe, fittings, valves, equipment and all other existing items similar to proposed items specified for painting. Miscellaneous metal items to be painted shall be included in the Work of this Section where they come within the general intent of the Specifications or as stated herein.
- D. In general the following surfaces shall be painted:
 - 1. Pipe, fittings, flanges, appurtenances and other metal surfaces to 1 ft below grade. Pipe 1 ft below grade and within 6-inches above grade shall be considered immersion surface and shall be coated with the immersion surface high performance coating system.
 - 2. Metal or Galvanized materials including, but not limited to: pipe straps, hangers, pipe support floor stands, nuts, bolts, hardware and tapping saddles. Pipe straps to be removed and coated on both sides.
 - 3. Pipe Surfaces under pipe straps. Pipe straps shall be removed and pipe coated underneath pipe straps regardless if pipe straps are to be coated. No more than two-thirds of the total number of pipe straps shall be removed at any given time.
 - 4. Pedestrian access barriers shall be removed and coated on all sides.
 - 5. Incidentals within the limits of the project including but not limited to bollards, adjacent walkways, walls or supports containing graffiti.
 - 6. Contractor shall provide new 1/2" neoprene that shall be placed at contact interfaces between materials including, but not limited to, pipe support floor stands, pipe straps, and access barriers. The Contractor shall remove and replace existing neoprene where exposed with new material. In situations where 1/2" neoprene is not sized properly for existing conditions, the County on a case by case basis may require a different thickness.

- E. The following surfaces or items are not generally required to be painted, unless noted otherwise. The Contractor shall properly protect these materials from surface preparation, coating application, or damage.
 - 1. Products with polished chrome, aluminum, nickel, Stainless steel, brass, or bronze materials.
 - 2. Stainless steel finish hardware.
 - 3. Flexible couplings.
 - 4. Labels, signs or nameplates including but not limited to: UL, FM, equipment identification, performance rating, name and nomenclature plates.
 - 5. Aluminum handrails, walkways, window, louvers, and grating unless otherwise specified herein.

1.02 REFERENCES

- A. SSPC – Society for Protective Coatings
- B. ASTM – American Society of Testing Materials
- C. NACE – National Association of Corrosion Engineers
- D. NSF – National Sanitation Foundation (Standard 61)
- E. AWWA – American Water Works Association

1.03 DEFINITIONS

- A. Field Coating is the coating of new or rebuilt items at the job site. Field coating shall be the responsibility of the Contractor.
- B. Shop Coating is the coating of new or rebuilt items in the shop prior to delivery to the jobsite.
- C. Exterior – Outside, exposed to weather
- D. Interior – Inside, not subject to immersion service
- E. Immersion service – Material submerged or subject to splash or spray
- F. WFT – Wet Film Thickness
- G. DFT – Dry Film Thickness
- H. MDFT – average minimum dry film thickness
- I. SCARIFY – Roughen the entire existing coating surface by use of brush off blasting, hand tools, sanding, etc to provide an anchor profile for adhesion by new coating systems. Scarified surface shall be approved by the Coatings manufacturer and County prior to over-coating. Existing rust spots, weld slag, sharp edges, defects etc shall be removed by SSPC-SP3 Power tool cleaning.

- J. General: The following referenced surface preparation specifications of the Joint Surface Preparation Standards from NACE International (NACE) and The Society for Protective Coatings (SSPC) shall form a part of this Specification:
1. SSPC-SP1 Solvent Cleaning. Remove all grease, oil, salt, acid, alkali, dirt, dust, wax, fat, foreign matter, and contaminants, etc. by one of the following methods: steam cleaning, alkaline cleaning, or volatile solvent cleaning. Rags and solvents must be replenished frequently to avoid spreading the contaminant rather than removing it. Low-pressure (1500-4000 psi) high volume (3-5 gal/min) water washing with appropriate cleaning chemicals is a recognized "solvent cleaning" method. All surfaces should be cleaned per this Specification prior to using hand tools or blast equipment and between each coating application.
 2. SSPC-SP2 Hand Tool Cleaning. Removal of loose rust, loose mill scale, loose paint and loose foreign matter to a clean sound substrate by hand chipping, scraping, sanding, and wire brushing. Tightly adherent rust, mill scale or paint may remain providing that it cannot be removed by lifting with a dull putty knife
 3. SSPC-SP3 Power Tool Cleaning. Removal of loose rust, loose mill scale, loose paint and loose foreign matter, to a clean sound substrate by power tool chipping, descaling, sanding, abrasive grinding wheels, needle guns, wire brushes, etc. Tightly adherent rust, mill scale or paint may remain providing that it cannot be removed by lifting with a dull putty knife
 4. SSPC-SP5 White Metal Blasting (NACE-1). Complete removal of all visible oil, grease, dust, dirt, mill scale, rust, coating, oxides, corrosion products, and other foreign matter, leaving the surface a uniform gray-white color.
 5. SSPC-SP6 Commercial Blast (NACE-3). Complete removal of all visible oil, grease, dust, dirt, mill scale, rust, coating, oxides, corrosion products, and other foreign matter, leaving only light shadows or discolorations from stains of rust, mill scale, or previous coating on 33% of the unit surface area. At least 66% of each unit surface area is to be free of all visible discoloration or staining.
 6. SSPC-SP 7 Brush-Off Blast (NACE 4). Complete removal of oil, grease, dust, dirt, loose rust, loose mill scale, and loose coatings, leaving tightly adherent mill scale, rust and previous coating. Tightly adherent rust, mill scale or paint may remain providing that it cannot be removed by lifting with a dull putty knife.
 7. SSPC-SP10 Near White Blast (NACE 2). Complete removal of all visible oil, grease, dust, dirt, mill scale, rust, coating, oxides, corrosion products, and other foreign matter, leaving only light shadows or discolorations from stains of rust, mill scale, or previous coating on 5% of the unit surface area. At least 95% of each unit surface area is to be free of all visible discoloration or staining.
 8. SSPC-SP 11 Power Tool Cleaning to Bare Metal. Complete removal of all visible oil, grease, dirt, dust, mill scale, rust, paint, oxide, corrosion products, and other foreign matter and retain or produce a minimum 1.0 mil surface profile. Slight residues of rust and paint may be left in the lower portion of pits if the original surface is pitted.
 9. SSPC-SP 12 Waterjetting (NACE-5). Surfaces preparation by ultra-high pressure water jetting discharged from a nozzle at pressures of 70 MPa (10,000 psig) or greater to prepare a surface for coating or inspection. The difference in degrees of surface cleanliness is defined by the amount of pressure as follows:
 - a. Low Pressure Water Cleaning (LP WC) Less than 34 MPa (5,000 psi)
 - b. High Pressure Water Cleaning (HP WC) 34 to 70 MPa (5,000-10,000 psi)

- c. High Pressure Water Jetting (HP WJ) 70 to 210 MPa (10,000-30,000 psi)
 - d. Ultra-High Pressure Water Jetting(UHP WJ) Above 210 MPa (30,000 psi)
 - e. WJ-1 Clean to Bare Substrate: Complete removal of all visible rust, dirt, previous coatings, mill scale, and foreign matter. Discoloration of the surface may be present.
 - f. WJ-2 Very Thorough or Substantial Cleaning: Complete removal of all visible oil, grease, dirt, and rust except for randomly dispersed stains of rust, tightly adherent thin coatings, and other tightly adherent foreign matter limited to a maximum of 5% of the surface.
 - g. WJ-3 Thorough Cleaning: A WJ-3 surface shall be cleaned to a matte (dull, mottled) finish is free of all visible oil, grease, dirt, and rust except for randomly dispersed stains of rust, tightly adherent thin coatings, and other tightly adherent foreign matter limited to a maximum of 33% of the surface.
 - h. WJ-4 Light Cleaning: A WJ-4 surface shall be cleaned to a finish which is free of all visible oil, grease, dirt, dust, loose mill scale, loose rust, and loose coating. Any residual material shall be tightly adherent.
10. SSPC-SP13 Surface Preparation of Concrete (NACE-6). Complete removal of contaminants, laitance, form oils, dust, dirt, loosely adhering concrete, and previous coating. Blasting, High-pressure water cleaning or waterjetting methods should be performed sufficiently close to the surface so as to open up surface voids, bug holes, air pockets, and other subsurface irregularities, but so as not to expose underlying aggregate.
11. SSPC-SP 14 Industrial Blast Cleaning (NACE-8). Complete removal of oil, grease, dust, dirt, loose rust, loose mill scale, and loose coatings, leaving tightly adherent mill scale, rust and previous coating evenly distributed on 10% of the unit surface area. Stains and discolorations may be present on 90% of the unit area. Tightly adherent rust, mill scale or paint cannot be removed by lifting with a dull putty knife.
12. SSPC-SP 15 Commercial Grade Power Tool Cleaning. Complete removal of all visible oil, grease, dirt, rust, coating, oxides, mill scale, corrosion products, and other foreign matter, except random staining shall be limited to no more than 33 percent of each unit area of surface. Staining may consist of light shadows, slight streaks, or minor discolorations caused by stains of rust, stains of mill scale, or stains of previously applied coating. Slight residues of rust and paint may also be left in the bottoms of pits if the original surface is pitted. (Equivalent standard as SSPC-SP6 Commercial Grade Blast Cleaning NACE-3).

1.04 SUBMITTALS

- A. Submit to the Engineer as provided in the General Conditions and Division 1, shop drawings, manufacturer's specifications and data on the proposed paint systems and detailed surface preparation, application procedures and dry film thickness.

- B. Schedule of Painting Operations: The Contractor shall submit for approval a complete Schedule of Painting Operations within 30 days after the Notice to Proceed. It shall be the Contractor's responsibility to properly notify and coordinate with the County for schedule updates and site activities. This Schedule shall include for each surface to be painted, the brand name, the volume of solids, the coverage and the number of coats the Contractor proposes to use in order to achieve the specified dry film thickness. When the schedule has been approved, the Contractor shall apply all material in strict accordance with the approved Schedule and the manufacturer's instructions. Wet and dry paint film gauges shall be utilized by the County to verify the proper application while Work is in progress.
- C. Protection and Containment Plan: The Contractor shall submit for approval the process, equipment, design, materials, requirements, disposal and methods to provide for protection of the environment, collection of abrasive blasting material, collection of existing coatings, protection of the public and protection for public access.
- D. Maintenance of Traffic Plan (MOT): The Contractor shall prepare and submit a Traffic Control Plan to the Owner, and Orange County Public Works Department or Florida Department of Transportation for review and acceptance prior to commencing any Work on the site. The Traffic Control Plan shall detail procedures and protective measures proposed by the Contractor to provide protection and control of traffic affected by the Work consistent with the following applicable standards:
1. Standard Specifications for Road and Bridge Construction, Latest Edition including all subsequent supplements issued by the Florida Department of Transportation (FDOT Spec.).
 2. Manual of Traffic Control and Safe Practices for Street and Highway construction, Maintenance and Utility Operations, FDOT.
 3. Right-of-Way Utilization Regulations, Orange County, Florida, latest edition.
- E. Test panels/samples: At the request of the County, samples of the finished work prepared in strict accordance with these Specifications shall be furnished, and all painting shall be equal in quality to the approved samples. Finished areas shall be adequate for the purpose of determining the quality of workmanship. Experimentation with color tints shall be furnished to the satisfaction of the County where standard chart colors are not satisfactory.
- F. Equivalent materials of other manufacturers may be substituted on approval of the Engineer. Substitutions that decrease the film thickness, the number of coats applied, change the generic type of coating, or fail to meet the performance criteria of the specified materials will not be approved. Prime and finish coats of all surfaces shall be furnished by the same manufacturer. Requests for substitution shall include Manufacturer's literature for each product giving the name, generic type, descriptive information, evidence of satisfactory past performance, and an independent laboratory certification that their product meets the performance criteria of the specified materials including but not limited to the following:
1. Abrasion – Fed. Test Method Std. No. 141, Method 6192, CS-17 Wheel, 1,000 grams load
 2. Adhesion – Elcometer Adhesion Tester
 3. Exterior Exposure – Exposed at 45 degrees facing the ocean (South Florida Marine Exposure)
 4. Hardness – ASTM D3363-74

5. Humidity – ASTM D2247-68
6. Salt Spray (Fog) – ASTM B117-73

1.05 QUALITY ASSURANCE

A. Manufacturer's Qualifications

1. All paints and/or coatings applied in the performance of the Work shall be supplied by one paint supplier and be the product of one manufacturer; unless the County specifies or accepts a specialty paint not available from that manufacturer.
2. The paint manufacturer shall have supplied paint for water and wastewater facilities for a minimum of ten (10) years, and products supplied shall be contained within the manufacturer's standard water and wastewater brochure.
3. When the manufacturer's minimum recommendations exceed the specified requirements, Contractor shall comply with the manufacturer's minimum recommendations.

B. Contractor / Applicator Qualifications as listed below shall be submitted at the time of Bidding as part of the Bid Package.

1. The Contractor's Project Superintendent / Project Manager shall be at minimum certified NACE Level 1 and be in good standing with NACE International prior to bidding. The Contractor have a Competent Person onsite as defined by OSHA. Certification credentials shall be provided to the County and verifiable through the NACE.org certification search website.
2. The Contractor must show proof that all employees associated with this project shall have been employed by the Contractor for a period not less than six (6) months.
3. Painting shall be performed by experienced painters in accordance with the recommendations of the paint manufacturer and the Contract Documents. All paint shall be uniformly applied without sags, runs, spots, or other blemishes. Work that shows carelessness, lack of skill, or is defective in the opinion of the County, shall be corrected at the expense of the Contractor.
4. The applicator shall have practical experience and successful history in the application of the specified products to surfaces of water supply and wastewater collection and treatment facilities. A written list of references shall be provided to show experience and costs with high performance coatings on pipelines and aerial crossings as well with all other aspects with the defined Scope of Work.
5. The Contractor shall provide a list of equipment owned and maintained by the Contractor that shall be utilized on the project.
6. The Contractor shall provide their written QA / QC program.
7. Contractors shall submit their protection and containment plan to prevent blasting debris, paint chips, paint overspray from entering water bodies.

C. Safety and Health Requirements.

1. General: In accordance with the requirements of the OSHA Regulations for Construction, the Contractor shall provide and require the use of personal protective and lifesaving equipment for all persons working in or about the Project including, but not limited to, head and face protection, fall protection, safety harnesses and respiratory devices. Applicable health and safety precautions required by appropriate regulatory agencies such as OSHA, ANSI, etc., shall be followed.

2. Ventilation: Ventilation shall be adequate to reduce the concentration of air contaminants to the degree that a hazard to workers does not exist.
3. Sound Levels: Whenever the occupational noise exposure exceeds the maximum allowable sound levels, the Contractor shall provide and require the use of approved ear protective devices.
4. Illumination: Adequate illumination shall be provided while work is in progress. Whenever required by the County, the Contractor shall provide additional illumination and necessary support sufficient to cover all areas to be checked. The level of illumination required for observation purposes shall be determined by the County.
5. Temporary Ladders and Scaffolding: All temporary ladders and scaffolding shall conform to the applicable requirements of the OSHA Regulations for Construction. The Contractor shall provide access to the County for all areas of work during each phase of construction.
6. Safety of Public. Provide scaffolding, signage, temporary pedestrian access and barricades as required to protect the public from the work area. Areas to be closed off shall require public notice.

D. Pre-Job Conference

1. A pre-job meeting shall be held prior to the commencement of the Work, prior to significant phases or per specific site location if the Work is not contiguous. Attendance shall include the County, Engineer, Contractor, and Painters Site Supervisor. The meeting will address site specific issues including but not limited to: schedule, access to the site, safety requirements, surface preparation, application, coating systems, inspection, quality control, MOT, protection of the public and protection of the environment as covered in the specifications.
2. Copies of all manufacturer's instructions and recommendations shall be furnished to the County and Engineer by the Contractor prior to the meeting.
3. It shall be the responsibility of the Coating Manufacturer to have their factory representative meet in person with the Contractor and Engineer a minimum of three times during the job as a consultant on surface preparation, mil thickness of coating and proper application of coating unless meeting is determined to be unnecessary by the Engineer.

E. Surface Preparation

1. Visual Standard SSPC-VIS-1 (Swedish SIS OS 5900), "Pictorial Surface Preparation Standards for Painting Steel Surfaces" and The National Association of Corrosion Engineers, "Blasting Cleaning Visual Standards" (TM-01-70 and TM-01-75) shall be the standards used to evaluate proper surface preparation.
2. To facilitate inspection, the Contractor shall on the first day of blasting operations, blast metal panels (12" x 12" x 1/4") to the degree called for in the Specifications and as noted above. Once a sample panel has been approved, it shall establish the quality of all subsequent Work by reference. The sample shall then be stored in a dry, sealed plastic container on the job site. Sample panels shall be prepared and approved for each type of sandblasting specified and shall be maintained and utilized by the County throughout the duration of sandblasting operations as reference standards of quality. Coatings shall be applied only at temperatures and conditions recommended by the paint manufacturer.

F. Inspection Devices:

1. The Contractor shall utilize, until final acceptance of the Work, inspection devices in good working condition for the detection of holidays, environmental conditions, and measurements of wet and dry-film thicknesses of protective coatings. Inspection devices shall be operated in strict accordance with the manufacturer's printed instructions and applicable SSPC and NACE standards and guidelines.
2. Thickness and Holiday Checking: Thickness of coatings shall be checked with a nondestructive, magnetic type thickness gauge. Coating integrity of coated surfaces shall be tested with an approved holiday detection unit per the paint manufacturer's recommendation. All pinholes shall be marked, repaired in accordance with the paint manufacturer's printed recommendations and re-tested. No pinholes or other irregularities will be permitted in the final coating. In cases of dispute concerning film thickness or holidays, the Contractor shall abide by the County's determination unless independent tests are performed by a certified lab at the Contractor's expense. Field measurements of film thickness shall not exceed the requirements of SSPC-PA 2 Measurement of Dry Coating Thickness with Magnetic Gages. Discrepancies shall be measured and verified with a micrometer or Tooke gauge if no other option is available.

1.06 PRODUCT DELIVERY STORAGE AND HANDLING

- A. Delivery: All materials shall be delivered to the job in undamaged, original packages with seals unbroken and in legible, labeled containers. Packages shall not be opened until the County inspects them and they are required for use. Labels shall show name of manufacturer, type of coating, formulation, date, color and manufacturers' recommendations and instructions for use.
- B. Storage: All painting materials shall be stored in a clean, dry, well-ventilated place, protected from sparks, flame, and direct rays of the sun or from excessive heat. Paint susceptible to damage from low temperatures shall be kept in a heated storage space when necessary. The Contractor shall be solely responsible for the protection of the materials he stores at the job site. Empty coating cans shall be neatly stacked in areas the Owner designates, and shall be removed from the job site on a schedule the Owner determines.
- C. Mixing: Mechanical mixers, capable of thoroughly mixing the pigment and vehicle together, shall mix the paint prior to use where required by manufacturer's instructions, however, thorough hand mixing will be allowed for small amounts up to one gallon. Pressure pots shall be equipped with mechanical mixers to keep the pigment in suspension, when required by manufacturer's instructions. Otherwise, intermittent hand mixing shall be done to assure that no separation occurs. Materials shall be in full compliance with the requirements of pertinent codes and fire regulations.
- D. Thinning: Catalysts or thinners shall only be utilized as recommended by the manufacturer, and shall be added or discarded strictly in accordance with the manufacturer's instruction.

1.07 PROJECT SITE CONDITIONS

- A. Application: Paint shall be applied only on thoroughly dry surfaces and during periods of favorable weather, unless specifically allowed by the paint manufacturer. Except as provided below, painting shall not be permitted when the atmospheric temperature is below 50° F, or when freshly painted surfaces may be damaged by rain, fog, dust, or condensation, and/or when it can be anticipated that these conditions will prevail during the drying period.
- B. No coatings shall be applied unless the relative humidity is below 85%.
- C. No coatings shall be applied unless surface temperature is a minimum of 5° above dew point; temperature must be maintained during curing.

1.08 WARRANTY

- A. Warranty Inspection: Warranty inspection shall be conducted during the eleventh month of the one (1) year warranty period following completion of all painting Work. All defective Work shall be repaired in strict accordance with this Specification, and to the satisfaction of the paint manufacturer and the County.
- B. Fluoropolymer / Fluorourethane. The Contractor shall warrant through the Manufacturer that the coating system shall not: check, crack, blister or delaminate from the substrate; change color more than 12 MacAdam units as determined in accordance with ASTM D2244; exhibit loss of gloss in excess of 24 units as measured by a gloss meter in accordance with ASTM D523-8; or chalk in excess of a rating of 8 as measured in accordance with ASTM D4214, Method A. Warranty coverage shall be effective for a period of 15 years from Final Completion depending on color. The Contractor shall notify the Manufacturer prior to ordering materials and begin the warranty process. Sample panels shall be obtained from the Manufacturer, and at least 2 sample panels shall be provided to the County in addition to the Manufacturers minimum requirements regarding the warranty process. The Contractor shall not be permitted to install the coating system until the Manufacturer has provided assurance that the color, substrate, surface preparation or existing conditions are in conformance with the Manufacturer's requirements for warranty.

PART 2 - PRODUCTS

2.01 GENERAL

- A. The painting schedule has been prepared on the basis of Tnemec and Carboline products, and their recommendations for application.
- B. No paint containing lead shall be allowed.

2.02 COATING SYSTEMS

- A. The following summarizes the painting systems for various types of applications.

- B. The Contractor shall have the coating color matched or tinted by the coating supplier to exactly match Tnemec Color Codes as shown below. Manufacturers other than Tnemec shall submit a color matched swatch to the County for approval prior to ordering materials.

Color Table

Fluid Conveyed by Pipe	Tnemec Color Codes
Potable Water (WM)	True Blue 11SF
Wastewater (FM)	Hunter Green 08SF
Reclaimed Water (RWM)	Purple Rain 14SF

- C. Minimum film thickness shall be per manufacturer's recommendations unless a greater thickness is specified. The Contractor shall measure minimum film thickness in the field by utilizing a wet film gauge, which the County shall verify. Regardless of anchor profile, the Contractor shall utilize a wet film gauge to verify that the County-specified average minimum dry film thickness (MDFT) is being applied. The calculated value for wet film thickness (WFT) shall be derived from County's average MDFT unless the manufacturer's minimum range is greater. Following the manufacturer's recommended drying time, the Contractor shall measure and provide results to the County verifying that the average minimum dry film thickness meets the MDFT for each coat and final system, utilizing a dry film gauge. The County may conduct side-by-side verification.
- D. Coating systems shall incorporate the paints specified below, applied at the average dry film thickness (DFT) in mils per coat noted, and have the specified minimum average dry film thickness (MDFT) for each individual coat and total system.

HP – High Performance Coatings of FERROUS METALS

System HP-1
 EXTERIOR EXPOSURE, UV EXPOSURE (NON-IMMERSION)
 Complete removal of existing coating system

Coat	Tnemec	Carboline
Prime	Zinc Series 90-97 2.5 to 3.5 DFT Avg 3.0 MDFT	Carbozinc 621 3.0 to 8.0 DFT Avg 3.5 MDFT
Intermediate	Endura-Shield Series 73 2.0 to 3.0 DFT Avg 2.5 MDFT	Carbothane 133 HB 3.0 to 5.0 DFT Avg 3.5 MDFT
Finish	Hydroflon Series 700 2.0 to 3.0 DFT Avg 2.5 MDFT	Carboxane 950 2.0 to 3.0 DFT Avg 2.5 MDFT
Total	8 MDFT	9.5 MDFT

System HP-2
 EXTERIOR EXPOSURE, UV EXPOSURE (NON-IMMERSION)
 Over-coating of localized inaccessible existing coatings and galvanized metal

Coat	Tnemec	Carboline
Prime	Chembuild 135 4.0 to 9.0 DFT Avg 5.0 MDFT	Carboguard 553 3.0 to 4.0 DFT Avg 3.5 MDFT
Intermediate	Endura-Shield Series 73 2.0 to 3.0 DFT Avg 2.5 MDFT	Carbothane 133 HB 3.0 to 5.0 DFT Avg 3.5 MDFT
Finish	Hydroflon Series 700 2.0 to 3.0 DFT Avg 2.5 MDFT	Carboxane 950 2.0 to 3.0 DFT Avg 2.5 MDFT
Total	9.5 MDFT	9.5 MDFT

System HP-3
 EXTERIOR EXPOSURE, UV EXPOSURE (NON-IMMERSION)
 Over-coating of existing solvent based coating system exposed to UV

Coat	Tnemec	Carboline
Existing	Existing coating system	Existing coating system
Spot Prime	Chembuild 135 4.0 to 9.0 DFT Avg 5.0 MDFT	Carboguard 553 3.0 to 4.0 DFT Avg 3.5 MDFT
Intermediate	Chembuild 135 4.0 to 9.0 DFT Avg 5.0 MDFT	Carboguard 553 3.0 to 4.0 DFT Avg 3.5 MDFT
Finish	Hydroflon Series 700 2.0 to 3.0 DFT Avg 2.5 MDFT	Carboxane 950 2.0 to 3.0 DFT Avg 2.5 MDFT
Total	7.5 MDFT	6.0 MDFT

System HP-4
 INTERIOR/EXTERIOR EXPOSURE, NON-UV EXPOSURE (NON-IMMERSION)
 Over-coating of existing coating, or manufacturer epoxy-primed surface not exposed to UV

Coat	Tnemec	Carboline
Existing	Existing coating system	Existing coating system
Spot Prime	Chembuild 135 4.0 to 9.0 DFT Avg 5.0 MDFT	Carboguard 553 3.0 to 4.0 DFT Avg 3.5 MDFT
Intermediate	Chembuild 135 4.0 to 9.0 DFT Avg 5.0 MDFT	Carboguard 553 3.0 to 4.0 DFT Avg 3.5 MDFT
Finish	Hi-Build Epoxoline II Series N69 4.0 to 8.0 DFT Avg 4.5 MDFT	Carboguard 60 4.0 to 6.0 DFT Avg 4.5 MDFT
Total	9.5 MDFT	8.0 MDFT

System HP-5
 EXTERIOR EXPOSURE, (IMMERSION)
 Complete removal of existing coating system for immersion surfaces

Coat	Tnemec	Carboline
Prime	Zinc Series 90-97 2.5 to 3.5 DFT Avg 3.0 MDFT	Carbozinc 621 3.0 to 8.0 DFT Avg 3.5 MDFT
Intermediate	Hi-Build Epoxoline II Series N69 4.0 to 8.0 DFT Avg 4.5 MDFT	Carboguard 60 4.0 to 6.0 DFT Avg 4.5 MDFT
Finish	Hi-Build Epoxoline II Series N69 4.0 to 8.0 DFT Avg 4.5 MDFT	Carboguard 60 4.0 to 6.0 DFT Avg 4.5 MDFT
Total	12.0 MDFT	12.5 MDFT

System HP-6
 INTERIOR/EXTERIOR EXPOSURE, UV EXPOSURE (NON-IMMERSION)
 Over-coating of existing water based or unknown coating surface exposed to UV

Coat	Tnemec	Carboline
Existing	Existing coating system	Existing coating system
Spot Prime	Typoxy Series 27WB 4.0 to 14.0 DFT Avg 4.5 MDFT	NA
Intermediate	Typoxy Series 27WB 4.0 to 14.0 DFT Avg 4.5 MDFT	NA
Finish	Hydroflon Series 700 2.0 to 3.0 DFT Avg 2.5 MDFT	NA
Total	7.0 MDFT	NA

System HP-7
 EXTERIOR EXPOSURE, UV EXPOSURE (NON-IMMERSION)
 Over-coating of localized inaccessible existing coatings

Coat	Tnemec	Carboline
Prime	Chembuild 135 4.0 to 9.0 DFT Avg 5.0 MDFT	Carboguard 553 3.0 to 4.0 DFT Avg 3.5 MDFT
Intermediate	Chembuild 135 4.0 to 9.0 DFT Avg 5.0 MDFT	Carboguard 553 3.0 to 4.0 DFT Avg 3.5 MDFT
Finish	Hydroflon Series 700 2.0 to 3.0 DFT Avg 2.5 MDFT	Carboxane 950 2.0 to 3.0 DFT Avg 2.5 MDFT
Total	9.5 MDFT	8.0 MDFT

System HP-8
 INTERIOR/EXTERIOR EXPOSURE, NON-UV EXPOSURE (NON-IMMERSION)

Over-coating of localized inaccessible existing coating

Coat	Tnemec	Carboline
Existing	Existing coating system	Existing coating system
Spot Prime	Typoxy Series 27WB 4.0 to 14.0 DFT Avg 4.5 MDFT	NA
Intermediate	Enduratone Series 1029 2.0 to 3.0 DFT Avg 2.5 MDFT	NA
Finish	Enduratone Series 1029 2.0 to 3.0 DFT Avg 2.5 MDFT	NA
Total	5.0 MDFT	NA

DFT = Dry Film Thickness
 MDFT = Minimum Dry Film Thickness

2.03 EQUIPMENT

- A. The Contractor's surface preparation, coating and painting equipment shall be designed and suitable for the application of the specific materials herein specified. The Contractor shall submit a list of all applicable equipment owned by the Contractor. The Contractor's equipment shall be subject to the approval of the County based on the manufacturer's data.
- B. Effective oil and water separators shall be used in all compressed air lines serving spray painting and sandblasting operations to remove oil or moisture from the air before it is used. Separators shall be placed as far as practical from the compressor.
- C. The Contractor shall furnish all equipment for application of the paint and the completion of the Work in first-class condition and shall comply with recommendations of the paint manufacturer.

PART 3 - EXECUTION

3.01 GENERAL

- A. All coating and painting shall conform to the applicable requirements of the Society for Protective Coatings (SSPC) Manual (most recent edition). Any material applied upon improperly prepared surfaces shall be removed and redone to the satisfaction of the Owner at the sole expense of the Contractor.
- B. All Work shall be done by skilled craftsmen who are qualified to perform the required work and shall be done in a manner comparable to the best standards of practice found in that trade.

- C. The Contractor shall provide a supervisor to be at the work site during surface preparation, cleaning and coating operations. The supervisor shall have the authority to coordinate the work and make other decisions pertaining to the fulfillment of their contract.
- D. Prior to assembly, all surfaces that will be made inaccessible after assembly, shall be prepared as specified herein, and shall receive the paint or coating system as specified herein.
- E. Coating shall not be applied to wet or damp surfaces and shall not be applied in inclement weather. Do not apply when the surface temperature is less than 5° F above the dew point, or if relative humidity is greater than 85%. Dew or moisture condensation should be anticipated and if such conditions are prevalent, coating should be delayed until the surfaces are dry. Further, the day's coating should be completed well in advance of when condensation will occur, in order to permit the film a sufficient drying time prior to the formation of moisture.
- F. Any surfaces not specifically named in the Scope of Work, and not specifically exempted, shall be prepared, primed and painted in the manner and with materials consistent with these Specifications. The Owner shall select which of the manufacturer's products, whether the type is indicated herein or not, shall be used for such unnamed surfaces. No extra payment shall be made for this painting.
- G. Contractor shall inspect each pipe joint, pipe strap, personal barriers and appurtenances after providing access to the location but prior to commencing surface preparation activities. The Contractor shall immediately report leaks, damage, stripped bolts or nuts to the County.

3.02 SURFACE PREPARATION

- A. Solvent Cleaning: All dust, dirt, oil, or any contaminants that would affect the adhesion or durability of the finish coating must be removed before hand tool cleaning, abrasive blasting and prior to each coating layer application by cleaning per SSPC-SP1 "Solvent Cleaning."
- B. Defects: All ferrous metal surfaces shall be free of all defects. The Contractor shall remove by chipping or grinding all sharp edges; other defects shall be ground smooth in accordance with NACE Standard RPO178, Appendix C. Weld flux, weld spatter, slag and excessive rust scale shall be removed by SSPC-SP 11 Power Tool Cleaning to Bare Metal. All weld seams, sharp protrusions, and edges shall be ground smooth prior to surface preparation or application of any coatings.
- C. Gaskets: Existing gaskets in between flanged joints shall be cut or ground flush with the existing flanged joint prior to surface preparation or field blasting operations. The Contractor shall not field blast into bell and spigot joints or under tapping saddles. Contractor shall blast perpendicular to the pipe surface. SSPC-SP3 Power Tool Cleaning shall be used inside bells and against tapping saddles to avoid damage to gaskets and locking mechanisms.
- D. Field blasting cleaning for all surfaces shall be accomplished by dry sandblasting method unless otherwise directed, or the County provides written approval
 - 1. The abrasive used in blast cleaning shall produce an anchor profile in accordance with the recommendations of the manufacturer of the protective coating, which is to be applied to the surface being cleaned.

2. At all times during the blast cleaning operations, adequate means shall be employed to absolutely insure that existing protective coatings shall not be exposed to abrasion from blast cleaning operations.
3. All blast cleaned surfaces shall be carefully dried and cleaned prior to application of specified coatings. No coatings or paint shall be applied over damp or moist surfaces.
4. Field blasting and priming shall be completed on any particular area during the same workday, and the application of the primer shall follow immediately after surface preparation and cleaning prior to formation of any form of corrosion. If the surface is not primed within 8 hours, complete surface preparation shall be repeated.
5. The Contractor shall at all times keep the area of his work in reasonably clean condition shall not permit blasting materials to accumulate in an uncontrolled manner such as to constitute a nuisance or hazard to the satisfactory prosecution or the Work, operation of the existing facilities, public safety, environmental nuisances or public access.
6. "Touch-up systems will be same as original specification except that approved manufacturer's organic zinc-rich shall be used in lieu of inorganic zinc where this system was originally used. Also, strict adherence to manufacturer's complete touch-up recommendations shall be followed. Any questions relative to compatibility of products shall be brought to the attention of the COUNTY and Coating Manufacturer; otherwise, Contractor assumes full responsibility.
7. Areas that are inaccessible to abrasive blasting, including adjacent to concrete pedestals, tapping saddles, pressure gauges or other appurtenances shall be cleaned in accordance with SSPC-SP 11 "Power Tool Cleaning to Bare Metal" immediately adjacent to the area as approved by the County.

E. Specified Surface Preparation: All surfaces shall be cleaned per SSPC-SP1 "Solvent Cleaning". In addition to the surface preparation for the specific Service Condition, surface preparation shall be as follows:

Substrate	Condition	Surface Preparation
All Surfaces	All – Prior to Surface Preparation	SSPC-SP1 Solvent Cleaning
Steel	Exterior / Non-Immersion	SSPC-SP10 Near White Blast (NACE 2)
Steel	Exterior / Immersion	SSPC-SP5 White Metal Blasting (NACE-1)
Ductile Iron Pipe	Exterior / Non-Immersion	SSPC-SP6 Commercial Blast (NACE-3)
Ductile Iron Pipe	Exterior / Immersion	SSPC-SP10 Near White Blast (NACE 2)
Ferrous Metal	Exterior / Non-Immersion / Inaccessible to abrasive blasting	SSPC-SP 11 Power Tool Cleaning to Bare Metal
Galvanized Metals	Exterior / Non-Immersion	SSPC-SP 7 Brush-Off Blast (NACE 4)
PVC	Exterior / Non-Immersion	SSPC-SP1 Solvent Cleaning & Scarify by brush blast, power tools or hand sanding
Existing Coating System to be Over-Coated	Exterior / Non-Immersion	Scarify by brush blast, power tools or Hand Sanding with fine abrasive

1. Exposed Pipe: Bituminous coated pipe shall not be used in above ground or exposed locations and shall be factory primed for all new pipe installations. After installation all exterior, exposed flanged joints shall have the gap between adjoining flanges sealed with a flexible caulking shall meeting ASTM C-920 and shall be Sika Flex 1A or equal to prevent rust stains.
2. The Contractor shall not abrasive-blast or prepare more surface area than can be coated in the same day; prepare surfaces and apply prime coatings within an 8-hour period.
3. Contractor shall coordinate with the County prior to surface preparation. County approval shall be required prior to application of the prime coat.

3.03 APPLICATION EQUIPMENT

A. Brush and / or Rollers

1. Top quality, properly styled brushes and rollers shall be used. Rollers with a baked phenolic resin core shall be utilized.
2. The brushing or rolling shall be done so that a smooth coat, as nearly uniform in thickness as possible, is obtained. Brush or roller strokes shall be made to smooth the film without leaving deep or detrimental marks.
3. Surfaces not accessible to brushes or rollers may be painted by spray, by dauber or sheepskins, and paint mitt.
4. It may require 2 coats to achieve the specified dry film thickness if application is by brush and roller.

B. Air, Airless or Hot Spray

1. The equipment used shall be suitable for the intended purpose, shall be capable of properly atomizing the paint to be applied, and shall be equipped with suitable pressure regulators and gauges.
2. Paint shall be applied in a uniform layer, with a 50% overlap pattern. All runs and sags should be brushed out immediately or the paint shall be removed and the surface resprayed.
3. High build coatings should be applied by a crosshatch method of spray application to ensure proper film thickness of the coating.
4. Areas inaccessible to spray shall be brushed; if also inaccessible to brush, daubs or sheepskins shall be used, as the manufacturer authorizes.
5. Special care shall be taken with thinners and paint temperatures so that paint of the correct formula reaches the receiving surface.
6. Nozzles, tips, etc., shall be of sizes and designs as recommended by the manufacturer of the paint being sprayed.
7. Edges, corners, crevices, welds, and bolts shall be given a brush coat (stripe coat) of each coating. The stripe coat shall be applied by a brush and worked in both directions prior to spray application. Special attention shall be given to filling all crevices with coating.

3.04 WORKMANSHIP

A. General

1. Under no circumstances shall Asphaltic seal coats and mastics be overcoated.

2. Paints shall be mixed in proper containers of adequate capacity. All paints shall be thoroughly stirred before use and shall be kept stirred while using. No unauthorized thinners or other materials shall be added to any paint.
3. Only skilled painters shall be used on the Work, and specialists shall be employed where required.
4. Extreme care shall be exercised in the painting of all operable equipment, such as valves, electric motors, etc., so that the proper functioning of the equipment will not be affected.
5. The Contractor's scaffolding shall be erected, maintained, and dismantled without damage to structures, machinery, equipment or pipe. Drop cloths shall be used where required to protect the environment, the public, buildings, equipment, and areas surrounding the Work. All surfaces required to be clear for visual observations shall be cleaned immediately after paint application.
6. The prime coat shall be applied immediately following surface preparation within 8 hours of the same working day. All paint shall be applied by brushing, paint mitt and roller, conventional spraying, or airless spraying, using equipment approved by the paint manufacturer.
7. Each coat of paint shall be recoated as per manufacturer's instructions. Paint shall be considered recoatable when an additional coat can be applied without any detrimental film irregularities such as lifting or loss of adhesion.
8. Surfaces that will be inaccessible after assembly shall receive either the full specified paint system or three shop coats of the specified primer before assembly.
9. Finish colors shall be as specified per the color table in section 2.02 of this specification, and shall be factory mixed (i.e., the Contractor shall not tint the paint, unless the COUNTY and the Coating Manufacturer so authorizes.)
10. All shop-coated surfaces shall be protected from damage and corrosion before and after installation by treating damaged area immediately upon detection. Abraded or corroded spots on shop-coated surfaces shall be cleaned per SSPC-SP1 Solvent Cleaning" and then touched up with the same materials as the shop coat in accordance with the manufacturers instruction. At the discretion of the Owner, all shop coated surfaces that are faded, discolored, or that require more than minor touch up shall be field blast cleaned and repainted.

B. Field Coating: All painting at the site shall be designated "Field Coating".

1. All paint shall be at ambient temperature before applying, and no painting shall be done when the temperature is below 50 degrees F, in dust-laden air, when rain is falling, mist is present, when relative humidity exceeds manufacturer's recommendation when temperature is less than 5° F above the dew point, or until all traces of moisture have completely disappeared from the surface to be painted.
2. Protective coverings or drop cloths shall be used to protect existing appurtenances, concrete walkways, concrete structures, existing surfaces, the public, the environment and equipment. Care shall be exercised to prevent paint or coating overspray and spatter onto surfaces that are not to be painted. Surfaces from which such materials cannot be removed satisfactorily shall be painted or repainted, as required to produce, a finish satisfactory to the County.
3. All edges, corners, crevices, welds, hardware and irregular surfaces shall receive a brush coat (stripe coat) of the specified product for each coat prior to application of each complete coat.

4. Coating shall be applied in a neat manner that will produce an even film of uniform and proper thickness, with finished surfaces free from brush marks or other irregularities. Each coat shall be carefully examined and faulty material, poor workmanship, holidays, damaged areas and other imperfections shall be touched up prior to applying succeeding coats. Each coat shall be thoroughly dry and hard before the next coat is applied in accordance with the coating manufacturer's recommendations for drying time between coats. Coating shall be cleaned in accordance with SSPC-SP1 prior to the application of next coating. In no case shall coating be applied at a rate of coverage greater than the maximum rate recommended by the coating manufacturer.
5. Coating failures shall not be accepted and shall be entirely removed down to the substrate and the surface recoated. Failures include, but are not limited to, holidays, sags, checking, cracking, teardrops, fat edges, fisheyes, or delamination. Any repairs made on surfaces shall be repaired in accordance with the coating manufacturer's instructions.
6. Each coat shall be uniform in coverage and color. Successive coats of paint shall be tinted so as to make each coat easily distinguishable from each other with the final undercoat tinted to the approximate shade of the finished coat.
7. Painting shall be continuous and shall be accomplished in an orderly manner so as to facilitate inspection. Surfaces of exposed members that will be inaccessible after erection shall be cleaned and painted before erection.
8. All materials shall be applied in accordance with the manufacturer's instructions. If spray painting is required, Contractor shall accept all responsibility for any damage caused by overspray and/or drifting paint mist.
9. Caulking: The Contractor shall caulk all voids or interfaces including but not limited to: flanges, threads, nuts, saddles, gaps, voids or spaces between appurtenances and pipe to be coated immediately after the prime coat to prevent rust formation where ferrous metal is not accessible to surface preparation or blasting. Flexible caulking shall meet or exceed ASTM C-920 and shall be Sika Flex 1A or equal.

3.05 FIELD QUALITY CONTROL

At a minimum, the Contractor shall provide field quality control and verification of the coating film thickness utilizing the below methods.

- A. Wet Film Gauge. Both the Contractor and the County shall use a wet film gauge to verify the applied coating desired wet film thickness (WFT) to produce the required minimum DFT.

$$\text{Target WFT} = \text{County specified average MDFT} / \text{Volume Solids} \times 100\%$$

If thinner is applied per the manufacturer's recommendations, the volume of solids shall be reduced accordingly. Regardless of anchor profile, surface pattern or base metal calculation of the substrate, the gauge reported WFT shall meet the target WFT value for the substrate or previously coated surface to ensure the required average MDFT will be achieved.

- B. DFT Magnetic Gauge. Dry Film Magnetic Pull-Off Gauge (Type I) shall be utilized to determine DFT in accordance with SSPC-PA 2 "Measurement of Dry Coating Thickness with Magnetic Gages." The average of the readings shall meet the County-specified MDFT for each coating application. Electromagnetic Gauge (Type II) shall not be considered acceptable for use on this project.
- C. Holiday Testing: Each coating layer shall be holiday tested at the recommended 100-125 volts DC per mil in accordance with the latest edition of the following standards: NACE SP0188-2006, NACE Standard RP0490, ASTM G62 and per the manufacturers recommendations. All low voltage holiday testing shall be performed using a Tinker & Razor Model M-1 Holiday Detector, or equal. Areas found to have holidays shall be marked and repaired in accordance with the paint manufacturer's instructions.
- D. Destructive Testing: Destructive testing using a Tooke gauge shall only be utilized in cases of dispute regarding DFT. The County shall be permitted up to three (3) cuts using the Tooke Gauge and the Contractor shall be responsible for repairing the areas examined at no additional cost.
- E. Environmental Testing: humidity, dew point and temperature shall be constantly measured and logged. Any electronic gauges shall be first calibrated against a sling psychrometer each day.

3.06 INSPECTION OF SURFACES

- A. Before application of the prime coat and each succeeding coat, all surfaces to be coated shall be subject to inspection and approval by the County. The Contractor shall correct any defects or deficiencies before application of any subsequent coating. Coatings applied without County approval shall be removed and reapplied at no cost to the County.
- B. The Contractor shall provide the County access to all areas of the Work. All scaffolding or lifts shall be in compliance with OSHA requirements.
- C. The Contractor shall furnish samples of surface preparation and of painting systems to be used as a standard throughout the job, unless omitted by the County.
- D. When any appreciable time has elapsed or has exceeded the manufacturers recommendations between coatings, the County shall carefully inspect previously coated areas and surfaces that are damaged or contaminated, in the opinion of the County shall be cleaned and recoated at the Contractor's expense. Re-coating times of manufacturer's printed instructions shall be adhered to.
- E. Coating thickness shall be determined by the use of a properly calibrated "DeFelsko Positest FM" Type 1 Coating Thickness Gauge (or equal) for ferrous metal or a "Tooke" Paint Inspection gauge (or equal) for non-ferrous and cementitious surfaces. Please note that use of the "Tooke" gauge is classified as a destructive test.

3.07 PROTECTION, CONTAINMENT AND CLEAN-UP

- A. The premises shall at all times be kept free from accumulation of waste material and rubbish caused by employees or work. At the completion of the painting remove all tools, scaffolding, surplus materials, and all rubbish from and about the site and leave the area “broom clean” unless more exactly specified.
- B. It shall be the responsibility of the Contractor to protect at all times, in areas where painting is being done, floors, sidewalks, walls, bridges, environment, public property, equipment, vehicles, appurtenances, and finished surfaces adjacent to paint work. Cover all electric plates, surface hardware, nameplates, gauge glasses, etc., before start of painting work.
- C. The Contractor shall contain all spent abrasives, old paint chips, paint overspray and debris by means suitable to the County, including but not limited to, full shrouding of the area. The Contractor shall provide a complete design and plan of the intended shroud or cover. Care must be taken not to modify or damage the structure during the use of the shroud. If damage should occur, the Contractor is held responsible for all repairs. The Contractor's containment must be adequate enough to stop blasting residue from being released into the environment. There should be no visible emissions of particulate matter or visible deposits on the ground outside the containment area. Water jetting or wet abrasive blast cleaning for the purpose of removing paint and surface debris shall be conducted within a containment designed, installed, and maintained in order to capture paint chips and debris. Collection of the water is not required. Mesh containment materials that capture paint chips and debris while allowing the water to pass through shall have openings a maximum of 25 mils (625 microns) in greatest dimension. Low Pressure Water Cleaning for the purpose of removing chalk, dirt, grease, oil and other surface debris can be performed without additional containment provided paint chips are removed and collected prior to Low Pressure Water Cleaning (LP WC).
- D. At completion of the work, remove all paint where spilled, splashed, splattered, sprayed or smeared on all surfaces, hardware, equipment, painted, and unpainted surfaces.
- E. After completion of all painting, the Contractor shall remove from job site all painting equipment, surplus materials, and debris resulting from this work.
- F. The Contractor is responsible for the removal and proper disposal of all hazardous materials from the jobsite in accordance with Local, State, and Federal requirements as outlined by the Environmental Protection Agency.

END OF SECTION

SECTION 11305
SUBMERSIBLE PUMPS AND APPURTENANCES

PART 1 - GENERAL

1.01 DESCRIPTION

- A. Scope of Work: This Section specifies the furnishing, installation, and testing of submersible pumps and associated equipment for the duplex pump station(s), complete, tested and ready for operation. The pumps and associated equipment covered under this Section include the following requirements:
1. Two submersible pumps and motors for each duplex pump station or three submersible pumps and motors for each triplex pump station.
 2. The following accessories and associated equipment are to be provided by the pump supplier for each duplex/triplex pump station:
 - a. pump control panel
 - b. lifting cables and hooks
 - c. hatches and frames
 - d. electrical cables and cable hangers
 - e. level indicators/floats
 - f. mounting elbows, adapters and anchor bolts
 - g. seamless guide/slide rails with Type 316 stainless steel upper guide rail brackets
 - h. pump base plates
- B. Operating Requirements: Pumping equipment provided under this Section shall conform to Table 11305-A "Submersible Pumps Schedule."

1.02 QUALITY ASSURANCE

- A. Unit Responsibility: All equipment including but not limited to the pumps, motors, control panel and level sensors, access hatch frames and covers (for wetwell and valve box), pump mounting elbows, guide rails, pump base plates, pump lifting cable, cable holder, and startup service shall be supplied by the pump supplier to insure unit responsibility.
- B. Factory Tests: The pump manufacturer shall perform the following tests on each pump before shipment from the factory:
1. Megger the pump for insulation breaks or moisture.
 2. Prior to submergence, the pump shall be operated dry and be checked for correct rotation.
 3. Pump shall be operated for 30-minutes in a submerged condition.
 4. Pump shall be removed from test tank, meggered immediately for moisture, oil plugs removed for checking lower seal, inspection plug removed for checking of upper seal and possible water intrusion of stator housing.

5. A written certified test report giving the above information shall be supplied with each pump at the time of shipment.
6. All ends of pump cables shall be fitted with a rubber shrink fit boot to protect cable prior to electrical installation.

C. The Contractor shall furnish and install equipment from a single manufacturer.

1.03 SHOP DRAWINGS AND SUBMITTALS

A. Submittals shall be submitted to the County for review and acceptance prior to construction in accordance with the General Conditions and specifications Section 01300 "Submittals."

B. Certified pump test performance for:

1. Flow, gpm
2. Total Dynamic Head (TDH), feet
3. NPSHr, feet
4. Input Power and Shaft Power, horsepower
5. Overall Efficiency and Pump Efficiency, %

C. Layout drawings showing installation details with dimensions specific for this application.

D. Shop Drawings for all associated equipment and accessories specified under this Section in accordance with Division 1 in sufficient detail to enable the County to determine compliance with all stated specification requirements.

E. Operating Instructions: Operating and maintenance data shall be furnished to the County as provided in the General Conditions and Division 1. The instructions shall be prepared specifically for this installation and shall include all required cut sheets and operating and maintenance instructions for personnel unfamiliar with such equipment.

F. Manufacturer's Certification

1. After acceptance of pump Shop Drawings, factory performance test data will be submitted for approval on each pumping unit.
2. Tests shall be in accordance with the standards of the Hydraulic Institute including head, capacity, brake horsepower and pump efficiency.
3. A written certified test report shall be supplied with each pump at the time of shipment.

1.04 PRODUCT DELIVERY STORAGE AND HANDLING

A. All equipment shall be delivered in suitable packages, cases or crates, and stored or placed as directed by the manufacturer. Each package shall have an identifying mark and a complete list showing contents. Equipment shall not be stored directly upon the ground.

- B. All equipment shall be lifted and handled in a manner so as not to damage or deform the equipment in any way and in any special way as instructed by the manufacturer.
- C. All parts and equipment shall be properly protected so that no damage or deterioration will occur during a prolonged delay from the time of shipment until installation is completed and the units and equipment are ready for operation. Finished surfaces of all exposed pump openings shall be protected by securely bolted wood planks. Finished iron or steel surfaces not painted shall be properly protected to prevent rust and corrosion during periods of storage and installation and shall be satisfactory to the County up to the time of the final acceptance test.

1.05 WARRANTY

- A. Warranty: The pump manufacturer shall warrant the pumps being supplied to the County against defects in workmanship and materials for a period of 5-years or 10,000-hours under normal use, operation and service. The warranty shall cover 100% of parts and labor for the time specified and shall not be prorated.

PART 2 - PRODUCTS

2.01 GENERAL

- A. All material supplied shall be one of the products specified in Appendix D "List of Approved Products" appended to these technical specifications.

2.02 MANUFACTURERS

- A. The Contractor shall furnish and install motor driven totally submersible sewage pumps and associated equipment as provided by those submersible sewage pump manufacturers listed in Appendix D "List of Approved Products" to meet the requirements set forth in Table 11305-A.

2.03 MATERIALS

- A. All hardware and accessories in the wetwell shall be Type 316 stainless steel.

2.04 PUMPS AND ACCESSORIES

- A. General
 1. Brass or stainless steel nameplates identifying the name of the manufacturer, voltage, phase, rated horsepower, speed and any other pertinent data shall be attached to each pump.
 2. Anchors and Fasteners: All necessary foundation bolts, plates, nuts, and washers shall be furnished by the equipment manufacturer and shall be Type 316 stainless steel.

- B. Pump Design: The pumps shall be capable of handling raw unscreened domestic wastewater and passing a minimum 3-inch diameter solid sphere.
- C. Casing: The stator casing and oil casing shall be of gray cast iron construction, with all parts coming into contact with sewage protected by a corrosion resistant paint proven to withstand an environment of raw wastewater.
- D. Impeller: The impeller shall be constructed of gray cast iron, ASTM A-48, class 30 – 40. All external bolts and nuts shall be Type 316 stainless steel. Each pump shall be provided with a replaceable metallic wear ring system to maintain pump efficiency. Impellers can be of the closed or open type. The closed type can utilize a single or double vane. The open type shall be single or double vane with a self-cleaning, adjustable cast iron wear plate. All impellers shall be dynamically balanced and of non-clog design capable of passing solids, fibrous material, and heavy sludge and constructed with long throughways with no acute turns.
- E. Mechanical Seals: Each pump shall be provided with a tandem double mechanical seal running in an oil or air reservoir, composed of two separate lapped face seals, each consisting of one stationary and one rotating tungsten carbide or silicone ring with each pair held in contact by a separate spring, so that the outside pressure assists spring compression in preventing the seal faces from opening. The compression spring shall be protected against exposure to the pumped liquid. Silicone carbide may be used in place of tungsten carbide for the upper and lower seal. The pumped liquid shall be sealed from the oil or air reservoir by one face seal and the oil reservoir from the air filled motor chamber by the other. The seals shall require neither maintenance nor adjustment and shall be easily replaced. Seal shall be held in place by locking ring. Conventional double mechanical seals are not acceptable. Cartridge seals are acceptable.
- F. Guide Rails, Lifting Cable, and Discharge Elbow
 - 1. The design shall be such that pumping units will be automatically connected to the discharge piping when lowered into place on the discharge connection. Pump removal for service or inspection will be by quick disconnect and hoist retrieve. Removal shall not require personnel to enter the wetwell nor shall nuts, bolts or fasteners require removal. Each pump shall be fitted with 6-feet of Type 316 stainless steel, minimum Grade 50, 3/4-inch chain attached to the lifting mechanism and air craft rated 1/4-inch stainless steel cable provided between the cable holder and the chain ("Grip-eye System", or acceptable equal), to permit raising the pump for inspection and removal using a closed chain hook and electric hoist. The lifting bail shall be constructed of Type 316 stainless steel for each pump.
 - 2. A sliding guide bracket shall be an integral part of the pumping unit and the pump casing shall have a machined connecting flange to connect with the cast iron discharge connection, which shall be bolted to the floor of the wetwell with stainless steel anchor bolts and so designed as to receive the pump discharge flange without the need of any bolts or nuts.

3. Sealing of the pumping unit to the discharge connection shall be accomplished by a simple downward motion with the entire weight of the pumping unit guided by two Schedule 40 welded seamless Type 316 stainless steel guide bars which will press it tightly against the discharge connection. All Type 316 seamless tubular stainless steel guides shall be 2-inch diameter for use with pumps up to 25-horsepower. Pumps greater than 25-horsepower shall use 3-inch diameter Type 316 seamless tubular stainless steel guides. No portion of the pump shall bear directly on the floor of the wetwell and no rotary motion of the pump shall be required for sealing. Sealing at the discharge connection shall be metal-to-metal contact of the pump discharge and mating discharge connection.
 4. The pump base elbow design shall be interchangeable such that it will provide a watertight connection for any of the specified or otherwise accepted pumps without requiring any special tools, gaskets or adapters. Assembly shall be capable of receiving a standard Flygt pump without special modification to either the pump or existing base elbow.
 5. Approved pump manufacturers, if necessary to meet the above specification, shall provide a sliding guide bracket adapter.
 6. Pump base elbow shall be bolted to a 1-inch-thick steel pump base plate which is anchored to the wetwell floor at six locations with 6-inch epoxy anchors. Pump base plate shall extend 6-inches beyond the pump volute and base elbow and trimmed to fit as necessary.
- G. Pump Motor: All motors shall be built in accordance with the latest NEMA, IEEE, ANSI and AFBMA Standards where applicable. The pump motor shall be housed in an air filled watertight casing and shall have Class H insulated windings which shall be moisture resistant. The motors shall be NEMA Design B rated 155°C maximum. Pump motors shall have cooling characteristics suitable to permit continuous operation in a totally, partially or non-submerged condition. The pump shall be capable of running continuously in a totally dry non-submerged condition under full load without damage for extended periods. Before final acceptance a field running test demonstrating this ability, with 24-hours of continuous operation under the above conditions, shall be performed for all pumps being supplied as required by the County. The motor shall be capable of a minimum of 10 starts per hour. Motors 25-horsepower and below shall be rated 230/460-volt, 3-phase and speed shall be nominal 1,750 RPM or less. Motors greater than 25-horsepower shall be 460 volt, 3-phase and speed shall be nominal 1,750 RPM or less. Pump motors shall be non-overloading over the entire published performance curve.
- H. Heat and Moisture Sensors: Each motor shall incorporate a minimum of one ambient temperature compensated overheat sensing device. This protective device shall be wired into the pump controls in such a way that if excessive temperature is detected the pump will shut down. This device shall be self-resetting.

- I. Cables: Cables shall be designed specifically for submersible pump applications and shall be properly sealed. A type CGB watertight connector with a neoprene gland shall be furnished with each pump to seal the cable entry at the control panel. The pump cable entry seal design shall preclude specific torque requirements to insure a watertight and submersible seal. The cable entry shall be comprised of a single cylindrical elastomer grommet, flanked by washers, all having a close tolerance fit against the cable outside diameter and the entry inside diameter and compressed by the entry body containing a strain relief function, separate from the function of sealing the cable. The assembly shall bear against a shoulder in the pump top. The cable entry junction chamber and motor shall be separated by a stator lead sealing gland or terminal board, which shall isolate the motor interior from foreign material gaining access through the pump top. Secondary sealing systems utilizing epoxy potting compounds may be used. The manufacturers shall supply a cable cap as part of the spare parts for each pump when this type of sealing system is used. All cables shall be continuous, without splices from the motor to the control panel, unless otherwise approved by the County. The junction chamber containing the terminal board shall be perfectly leak proof.
- J. Special Tools and Spare Parts
 1. Special Tools: Provide special tools for normal operation and maintenance in accordance with the Appendix B "Pump Station Start-Up Report" form.
 2. Spare Parts: The pump supplier will include at least one set of spare parts with a toolbox as detailed in accordance with Appendix B "Pump Station Start-Up Report" form.
- K. Pump Access Hatch and Frame
 1. Material: Structural aluminum or Type 316 stainless steel.
 2. Design
 - a. Liveload: 300-pounds per square foot.
 - b. Regular extruded angle section frame.
 - c. Hatch cover (diamond pattern) opens 90° (degrees) and locks automatically with stainless steel positive locking arm and release handle. Hatch cover shall be permanently embossed "CONFINED SPACE" and painted lettering shall not be acceptable. Each door shall be equipped with a recessed hasp enclosure.
 3. Frame attachments (all Type 316 stainless steel)
 - a. Upper guide rail holders
 - b. Lift cable holder
 4. Hatch hinges: heavy-duty Type 316 stainless steel hinges with tamper proof fasteners.
 5. Accessories
 - a. Lifting handle: Type 316 stainless steel.
 6. Finish: Mill finish with bituminous coating applied to exterior of frame.

PART 3 - EXECUTION

3.01 INSTALLATION

- A. All materials and equipment shall be installed as shown on the Drawings and as recommended by the manufacturers.

- B. Additional items of construction, such as concrete work, interior grouting, piping, vents, valves, controls, and other items necessary for the complete installation of the system shall conform to specific details on the Drawings and shall be constructed of materials conforming to the applicable portions of these Specifications.

3.02 INSPECTION, TESTING AND CERTIFICATION

- A. Inspection, Testing and Certification shall comply with Section 01650 "Pump Station Start-Up and Testing."

END OF SECTION

1

THIS PAGE LEFT BLANK INTENTIONALLY

TABLE 11305-A

SUBMERSIBLE PUMPS SCHEDULE FOR ROUSE/UNIVERSITY PS # 3365		
1. Manufacturer	Flygt	ABS
2. Model Number	CP3152.181 MT	PE 105/4
3. Impeller Number	63-434-00-5300	XFP150E-CB1
4. No. of Pumps Required	2	2
5. Pump Size, Inches	6	6
6. Primary Capacity, GPM / Total Head, Feet	910/41	830/41
7. Run-out Capacity, GPM / Total Head, Feet	1450/14	1480/12
8. Shut-off / Total Head, Feet	82	75
9. Motor, HP (NEMA Code)	20	14
10. Maximum Speed, RPM	1750	1760
11. Explosion Proof Motor Required (yes or no)	No	No
12. Voltage, Volts	230	230
13. Phase	3	3
14. Frequency, Hertz	60	60
15. Service	Raw Unscreened Sewage	Raw Unscreened Sewage
16. Minimum solid sphere size	4-inch	4-inch
17. Minimum Pump Efficiency at Primary Capacity, %	52	70
18. Submergence Requirement, Inches	17	14.1
19. Minimum Height of Base Elbow, Inches	14.5 (Top)	9.8 (Center)
20. Distance from Pump Volute to Base Plate, Inches	17.75	17.7

SUBMERSIBLE PUMPS SCHEDULE FOR LENA STREET PS # 3309		
1. Manufacturer	Flygt	ABS
2. Model Number		PE 35/6
3. Impeller Number		XFP100E-CB1
4. No. of Pumps Required		2
5. Pump Size, Inches		4
6. Primary Capacity, GPM / Total Head, Feet		190/21
7. Run-out Capacity, GPM / Total Head, Feet		480/10
8. Shut-off / Total Head, Feet		30
9. Motor, HP (NEMA Code)		4.7
10. Maximum Speed, RPM		1170
11. Explosion Proof Motor Required (yes or no)		No
12. Voltage, Volts		230
13. Phase		3
14. Frequency, Hertz		60
15. Service		Raw Unscreened Sewage
16. Minimum solid sphere size		3-inch
17. Minimum Pump Efficiency at Primary Capacity, %		48.9
18. Submergence Requirement, Inches		12.9
19. Minimum Height of Base Elbow, Inches		8.9 (Center)
20. Distance from Pump Volute to Base Plate, Inches		14.6

SUBMERSIBLE PUMPS SCHEDULE FOR ALLISON OAKS PS # 3893		
1. Manufacturer	Flygt	ABS
2. Model Number	CP3102	XFP 100E CB1.5-PE56/4
3. Impeller Number	433	ABS 1-VANE CHANNEL-195mm
4. No. of Pumps Required	2	2
5. Pump Size, Inches	4	4
6. Primary Capacity, GPM / Total Head, Feet	363/23	103/23.6
7. Run-out Capacity, GPM / Total Head, Feet	560/12	470/10
8. Shut-off / Total Head, Feet	0/42.4	0/29.6
9. Motor, HP (NEMA Code)	5	5
10. Maximum Speed, RPM	1745	1760
11. Explosion Proof Motor Required (yes or no)	YES	YES
12. Voltage, Volts	230	230
13. Phase	3	3
14. Frequency, Hertz	60	60
15. Service	Raw Unscreened Sewage	Raw Unscreened Sewage
16. Minimum solid sphere size	3 inch	3.1 inch
17. Minimum Pump Efficiency at Primary Capacity, %	61.9	37.6
18. Submergence Requirement, Inches	11	12.9
19. Minimum Height of Base Elbow, Inches	10.25 (TOP)	8.9 (Center)
20. Distance from Pump Volute to Base Plate, Inches	15.75	14.6

SUBMERSIBLE PUMPS SCHEDULE FOR GREENVIEW PINES PS # 3887

1. Manufacturer	Flygt	ABS
2. Model Number	CP3102	XFP 100E CB1.5-PE56/4
3. Impeller Number	435	ABS 1-VANE CHANNEL-185mm
4. No. of Pumps Required	2	2
5. Pump Size, Inches	4	4
6. Primary Capacity, GPM / Total Head, Feet	110/50	107/56.8
7. Run-out Capacity, GPM / Total Head, Feet	415/33	715/22
8. Shut-off / Total Head, Feet	0.5/58.7	0/66
9. Motor, HP (NEMA Code)	5	7.5
10. Maximum Speed, RPM	1745	1765
11. Explosion Proof Motor Required (yes or no)	YES	YES
12. Voltage, Volts	230	230
13. Phase	3	3
14. Frequency, Hertz	60	60
15. Service	Raw Unscreened Sewage	Raw Unscreened Sewage
16. Minimum solid sphere size	3 inch	3.1 inch
17. Minimum Pump Efficiency at Primary Capacity, %	46.4	29.6
18. Submergence Requirement, Inches	11	12.9
19. Minimum Height of Base Elbow, Inches	10.25 (TOP)	8.9 (CENTER)
20. Distance from Pump Volute to Base Plate, Inches	15.75	14.6

SUBMERSIBLE PUMPS SCHEDULE FOR BRADFORD COVE PS # 3890		
1. Manufacturer	Flygt	ABS
2. Model Number	CP3201	XFP PE3-PE6
3. Impeller Number	434	ABS 1-VANE CHANNEL-185mm
4. No. of Pumps Required	2	2
5. Pump Size, Inches	4	4
6. Primary Capacity, GPM / Total Head, Feet	276/37	216/41.1
7. Run-out Capacity, GPM / Total Head, Feet	750/11	690/15
8. Shut-off / Total Head, Feet	0/51	0/57
9. Motor, HP (NEMA Code)	7.5	6
10. Maximum Speed, RPM	1735	1765
11. Explosion Proof Motor Required (yes or no)	YES	YES
12. Voltage, Volts	230	230
13. Phase	3	3
14. Frequency, Hertz	60	60
15. Service	Raw Unscreened Sewage	Raw Unscreened Sewage
16. Minimum solid sphere size	3.1 inch	3.1 inch
17. Minimum Pump Efficiency at Primary Capacity, %	54.4	52.5
18. Submergence Requirement, Inches	11	12.9
19. Minimum Height of Base Elbow, Inches	10.25 (TOP)	8.9 (CENTER)
20. Distance from Pump Volute to Base Plate, Inches	15.75	14.6

THIS PAGE LEFT BLANK INTENTIONALLY

SECTION 13423
LEVEL MEASUREMENT

PART 1 - GENERAL

1.01 SUMMARY

- A. Section includes the following:
 - 1. Cord type float switch.

PART 2 - PRODUCTS

2.01 MANUFACTURERS

- A. Subject to compliance with specified requirements, see Appendix D for manufacturers offering products which may be incorporated in Work.

2.02 FLOAT SWITCH (CORD TYPE)

A. Free cable acting float switch shall be furnished to automatically detect liquid level change. Liquid rise of 1-inch from rest position shall operate float switch and reset will occur when liquid level drops 1-inch.

B. Float switch shall consist of type 316 stainless steel housing, flexible 3-conductor cable with a synthetic rubber jacket, and mercury switch. Inside float housing will be a (normally open/closed) mercury switch potted in epoxy. Electrical load for switch contacts shall be rated 115 volt AC at 0.5-horsepower inductive load.

C. Three-conductor cable shall be 14 AWG with 105-strands per conductor made for heavy flexing service and underwater use. A green grounding wire shall connect internally to float housing.

PART 3 - EXECUTION (NOT USED)

END OF SECTION

THIS PAGE LEFT BLANK INTENTIONALLY

SECTION 13430
PUMP STATION CONTROL PANELS

PART 1 - GENERAL

1.01 SUMMARY

- A. Section Includes:
1. **Intrinsically safe isolator relays.**
 2. **Terminal blocks.**

1.02 SUBMITTALS

- A. Shop Drawings covering the items included under this Section shall be submitted in accordance with Section 01300, "Submittals."

1.03 QUALITY ASSURANCE

- A. Regulatory Requirements
1. **Codes, Ordinances, and Industrial Standards: Design, testing, assembly, and methods of installation for materials, electrical equipment, and accessories proposed under this Section shall conform to National Electric Code and to applicable State and local requirements.**
 2. **UL listing and labeling of custom-built panels (UL 508) shall be adhered to under this Contract.**

PART 2 - PRODUCTS

2.01 MANUFACTURERS

Subject to compliance with specified requirements, approved manufacturers are listed in Appendix D "Orange County Utilities, Standards and Construction Specifications Manual", dated February 11, 2011.

2.02 CONTROL PANEL

- A. Panel Construction
1. **The Contractor shall furnish and install all the necessary panels, meter cabinets, disconnects, conductors, conduits, and other associated electrical components for a complete electrical system. All work shall conform to the latest national and local codes and be in strict conformance with Orange County standards as previously identified. All material and equipment shall be Underwriters Laboratories (UL) listed. All coordination for service and metering shall be accomplished by the Contractor at no additional cost to the County. The Work shall include complete testing of all equipment, components and wiring to**

- demonstrate proper functioning of the system.
2. **The manufacturer of the control panel shall be UL certified and provide data to indicate that the manufacturer has a minimum of 3-years experience in the building of pump control panels.**
 3. **The duplex pump control panel shall be housed in a NEMA 12/3R, Type 316, 14-gauge stainless steel enclosure, with drip shield and door gasket. The control panel door shall be operated by a 3-point latch. An additional remote access terminal strip with thirty additional terminal blocks shall be added for SCADA. Enclosure shall have provisions for padlocking the door and a dead front inner door unit for mounting controls. All exterior hardware and hinges shall be stainless steel. All LCD screens shall have an aluminum sunshield painted white with hinged flap covering the screen surrounding the manufacturer's enclosure.**
 4. **There shall be permanently affixed to the interior side of the enclosure door both a nameplate and a 10-inch by 12-inch pocket for log sheet storage. The nameplate shall contain the following information:**
 - a. voltage
 - b. phase
 - c. rated horsepower
 - d. rpm
 - e. date manufactured
 - f. pump and control panel manufacturer's name
 - g. pump data
 - h. impeller data
 - i. operating point including design flow and head
 - j. kilowatt input
 - k. amperes at the operating point and at least 2 other points on the pump curve
 - l. pump serial numbers.
 5. **The control panel enclosure shall be UL 50 type NEMA 3R listed. Overhead T-8 fluorescent lighting shall be controlled by a single pole switch installed inside of the control panel. Light shall be mounted on the inside of the door.**
 6. **The control panel shall consist of a main circuit breaker and generator breaker with mechanical interlock, an emergency power receptacle, a circuit breaker and magnetic starter for each pump motor, and 20-ampere, 120 volt circuit breakers as required. The main circuit breaker and generator circuit breaker shall be equal in rating. Each panel shall contain an additional 20-ampere breaker for SCADA purposes. All circuit breakers shall be operable through the dead front inner door. Additional multi-lug assemblies shall be provided to prevent more than 1-wire per lug. All circuit breakers shall be molded case. The control panel shall respond to liquid level float switches and other approved methods specified by Appendix D "List of Approved Products", to automatically start and stop pumps as well as sound an alarm upon high or low wetwell levels. Control switches shall provide means to operate each pump manually or automatically. When operated in the automatic mode, the control assembly shall provide means to manually select or automatically alternate the position of the "lead" and "lag" pumps after each pumping cycle. A float type liquid level control system shall continuously monitor wetwell liquid level and control operation of the low-level cutoff for the pumps and shall operate off a 24-VAC circuit.**

7. **The control panel shall operate a minimum of 2 electrical submersible pumps at the power characteristics specified. The control function shall provide for the operation of the lead pump under normal conditions. If the incoming flow exceeds the pumping capacity of the lead pump, the lag pump shall automatically start to handle this increased flow. As the flow decreases, pumps shall be cut off at the elevation as shown on the Drawings. Pumps shall alternate positions as lead pump at the end of each cycle. A failure of the alternator shall not disable the pumping system. The alternator shall include a safe, convenient method of manual alternation and also have provisions to prevent automatic alternation without disturbing any wiring. Should the "pump off" regulator fail, the system shall keep the station in operation.**
8. **The control panel shall be compatible with both of the manufacturers' pumps listed in Table 11305-A - Submersible Pumps Schedule.**

B. Power Supply and Main Disconnect

1. **Power supply to the control panel shall be 120/240 volt, 3-phase, 4-wire (Open Delta or Closed Delta from Electric Utility) or 480 volt, 3-phase, 3-wire (Y). Minimum service shall be 100-amperes. Single-phase power shall not be accepted.**
2. **A lockable, non-fused disconnect shall be used for service main disconnects at all stations. In all pump stations, a main disconnect shall be installed between the meter and the panel. Exception: At pump stations with a generator and transfer switch, provide molded case circuit breaker located ahead of transfer switch for service main disconnect.**
3. **Disconnect shall be rated for the maximum available fault current from the utility serving the pump station with electrical power as shown on the electrical plans.**
4. **On all 480 volt systems, an additional UL approved lockable, non-fused, safety type switch utility service disconnect shall be installed ahead of the meter.**
5. **Contractor shall be responsible for coordination of the electrical service with the utility providing power for the installation.**

C. Motor Circuit Protectors

1. **Each pump motor shall be protected by a 3-pole molded case circuit breaker (See Appendix D "List of Approved Products"). The motor circuit breaker shall be operated by a toggle type handle and shall have a quick make, quick break over-center switching mechanism that is mechanically trip free from the handle so that the contacts cannot be held closed against a short circuit and abnormal currents which cause the motor circuit breaker to trip. Tripping shall be clearly indicated by the handle automatically assuming a position midway between the normal "on" and "off" positions. All latch surfaces shall be ground and polished. All poles shall be so constructed that they open, close, and trip simultaneously. Motor circuit breaker must be completely enclosed in a high strength glass polyester molded case. Ampere ratings shall be clearly visible. Contacts shall be of non-welding silver alloy. Arc extinction must be accomplished by means of arc chutes. A manual push to trip button shall be provided for manual exercising of the trip mechanism.**

D. Motor Starter and Selector Switches

1. **The panel shall contain a motor starter for each motor. The motor starter shall be across-the-line non-reversing magnetic starter with individual mechanical overload protection on each power leg with reset installed through the dead front inner door unit. Provide solid-state soft start overloads for motors greater than 50-horsepower. Local power company regulations shall govern.**
2. **Selector switches shall be installed on the face of the inner dead front door unit. Selector switch shall be a heavy-duty NEMA 4X "Hand Off Auto" 3-position switch to control the operation mode of each pump motor starter.**
3. **Motor Disconnect: Where pump motor disconnect and starter is not mounted within site of pump wetwell, (where electrical equipment is mounted within a building or other enclosure) provide additional NEMA 4X stainless steel non-fused disconnect for each pump within site of pump location.**

E. **Pump Alternator:** A solid-state alternator shall be provided to change the pump starting sequence on each pumping cycle. A 3-position alternator test switch shall be provided to control the alternation operation. Switch positions to include the "auto" to provide normal automatic sequence, "off" position to disable alternator, and "test" position with a spring return to allow the alternating of the pump sequence to check alternator operation.

F. Lights and Alarms

1. **Indicator Lights:** There shall be installed on the face of the dead front inner door, heavy-duty NEMA 4X indicator lights as shown on the STANDARD DRAWINGS.
2. **High Level Alarm:** A vapor-proof red light shall be mounted on top of the panel and horn shall be mounted on the side of the panel for high level alarm. Also, there shall be an alarm silence pushbutton on the dead front inner door and a silence relay which will silence the horn and automatically reset when these signals are restored to normal. The pushbutton shall be heavy-duty oil tight. The red globe shall be the screw on type.

G. **Emergency Power Receptacle:** This item shall be required on all stations up to and including 200-ampere main service as approved in Appendix D "List of Approved Products."

H. Additional Control Panel Requirements

1. **Wiring**
 - a. All power wires shall be THW or THWN 75°C insulated stranded copper conductors and shall be appropriately sized for the given load application. All control circuit wire shall be type THW/THWN stranded. All wiring within the enclosure shall be neatly routed by the use of slotted type wiring duct with snap on type covers.
 - b. Interior wiring shall be neatly bundled with nylon ties and include sufficient loop across the hinges to prevent wire damage, with each end of conductor marked (ID), color: red, 24 volt; white, neutral; black, 120 volt.

2. **Terminal Points:** Terminal points of all terminal strips shall be permanently identified. All terminal numbers and identifying nomenclature shall correspond to and be shown on electrical diagrams. All wiring shall be permanently identified with heat shrink preprinted labels and be shown on electrical schematic diagrams.
3. **Engraved and/or etched Nameplates:** All equipment enclosures, circuit breakers, control switches, indicator pilot lights and other control devices shall be identified with permanently affixed legend plates and lamicoid type engraved nameplates where applicable. Nameplates may also be permanently etched into dead front cover of control panel.
4. **Transient Voltage Surge Suppressor (TVSS):** A transient voltage surge protector shall be included and wired to protect motors and control equipment from lighting induced line surges. All surge protectors shall be UL approved and installed per respective power company requirements and manufacturer's specifications. TVSS shall be attached to the load side of the station main disconnect and be mounted in a separate NEMA 4X enclosure.
 - a. The TVSS unit shall be UL listed and labeled as per UL 1449 Current edition.
 - b. The unit shall meet "Testing Requirements" of IEEE 62.41 and 62.45.
5. **Elapsed Time Meters:** Elapsed time meters shall be 115 volt not reset type and shall totalize pump running time in hours and tenths of hours to 99999.9 hours.
6. **Convenience Receptacle:** On the face of the dead front inner door unit, there shall be installed a 20-ampere 120 volt, duplex convenience receptacle. It shall be provided with its own single pole, 20-ampere circuit breaker for protection. Ground fault interrupt type shall be required.
7. **SCADA Circuit Breaker:** A 20A-1P, 120-VAC circuit shall be provided for connection to SCADA equipment provided for the pump station.
8. **Control Terminal Blocks:** Control terminal blocks shall be of the clamp screw type, rated for 600 volts. Amperage rating shall accommodate the control circuit amperage. An additional 30-space terminal strip shall be installed in the cabinet for future use, with RTU equipment.
9. **Control Power Transformers**
 - a. On 480 volt control panels, there shall be a control 480/120 volt power transformer with a minimum size of 2.52 KVA to provide 120-VAC power for: coils for starters, 20-ampere duplex receptacle, indicator pilot lights, alarm horn, alarm light, pump alternator, elapsed time meters, SCADA control panel, etc. The secondary side shall have 1 leg fused and the other grounded.
 - b. A 120/24-VAC 75 VA control power transformer shall provide power for float switches.
 - c. On 120/240 volt control panels an additional transformer may be required if SCCR is above 5000 amperes.
10. **Control Relay:** The level control relays shall operate from 24-VAC. They shall be enclosed, plug in 8-pin type with octal style screw terminal sockets.
11. **Electrical Schematic:** There shall be permanently affixed to the interior side of the exterior enclosure door an electrical schematic diagram and a copy supplied to County personnel at start up. The schematic shall be laminated and include the rated amperage and voltage for all components.

12. **Phase Monitor:** For all 240 volt stations an 8-pin plug in type phase monitor shall be provided for protection of electrical components due to phase loss. Adequate dummy pin protection shall be provided to prevent accidental interchanging of the 8-pin phase monitor with the 8-pin alternator. All 480 volt stations shall have surface mount type phase monitors. An approved breaker shall provide phase monitor protection. Fuses shall not be used for phase monitor protection.
13. **Panel Support:** Main support posts shall be minimum 3-inch, schedule 40, Type 316 stainless steel with Type 316 stainless steel cap. All other control panel support brackets and hardware shall be Type 316 stainless steel. Hardware shall include U-channel strut systems, brackets, nuts, bolts, washers, toggle bolts, clamps, straps, etc.

PART 3 - EXECUTION (NOT USED)

END OF SECTION

SECTION 15062
DUCTILE IRON PIPE AND FITTINGS

PART 1 - GENERAL

1.01 DESCRIPTION

- A. Scope of Work: Furnish all labor, materials, equipment and incidentals required and install, all ductile iron piping, ductile iron fittings, and appurtenances as shown on the Drawings and as specified herein.
- B. General Design: The equipment and materials specified herein are intended to be standard types of ductile iron pipe and cast or ductile iron fittings for use in transporting wastewater, potable water, and reclaimed water.

1.02 QUALITY ASSURANCE

- A. Qualifications: All of the ductile iron pipe and ductile or cast iron fittings shall be furnished by manufacturers who are fully experienced, reputable, and qualified in the manufacture of the materials to be furnished. The pipe and fittings shall be designed, constructed and installed in accordance with the best practices and methods and shall comply with these specifications as applicable.
- B. Standards:
 - 1. ANSI A 21.50/AWWA C150
 - 2. ANSI A-21.51/AWWA C151
 - 3. ANSI A-21.41/AWWA C104
- C. Factory Tests: The manufacturer shall perform the factory tests described in ANSI A-21.51/AWWA C151.
- D. Quality Control
 - 1. The manufacturer shall establish the necessary quality control and inspection practice to ensure compliance with the referenced standards. All pipe on this Project shall be supplied by a single manufacturer unless otherwise accepted in writing by the County.
 - 2. In addition to the manufacturer's quality control procedures, the County may select an independent testing laboratory to inspect the material at the foundry for compliance with these specifications. The cost of foundry inspection requested by the County will be paid for by the County.

1.03 SUBMITTALS

A. Materials and Shop Drawings

1. Submit Shop Drawings and piping layouts, including areas within and under buildings and structures. Shop Drawings shall include dimensioning, methods and locations of supports and all other pertinent technical specifications. Show locations of all field cuts. Shop Drawings shall be prepared by the pipe manufacturer. Shop Drawings for piping within and under buildings and structures shall be submitted within 30-days of Execution of Contract.

B. Operating Instructions: Submit Operation and Maintenance Manuals in accordance with Section 01001 "General Work Requirements."

C. Manufacturer's Certification

1. Submit manufacturer's sworn certification of factory tests and test results.

1.04 PRODUCT DELIVERY, STORAGE AND HANDLING

The Contractor shall be responsible for all materials furnished and stored until the date of project completion. The Contractor shall replace, at his expense, all materials found to be defective or damaged in handling or storage. The Contractor shall, if requested by the County, furnish certificates, affidavits of compliance, test reports, samples or check analysis for any of the materials specified herein. All pipe delivered to project site for installation is subject to random testing for compliance with the designated specifications.

A. Delivery and Storage: Delivery and storage of the materials shall be in accordance with the manufacturer's recommendations. Stored pipe shall be covered for protection against contamination and UV light. Joint gaskets shall be stored in clean, dark and dry location until immediately before use.

B. Handling: Care shall be taken in loading, transporting and unloading to prevent damage to the pipe and fittings and their respective coatings. Pipe or fittings shall not be rolled off the carrier or dropped. Pipe shall be unloaded by lifting with a forklift or crane. All pipe or fittings shall be examined before installation and no piece shall be installed which is found to be defective. Pipe shall be handled to prevent damage to the pipe or coating. Accidental damage to pipe or coating shall be repaired to the satisfaction of the County or be removed from the job. When not being handled, the pipe shall be supported on timber cradles or on level ground, graded to eliminate all rock points and to provide uniform support along the full pipe length. When being transported, the pipe shall be supported at all times in a manner which will not permit distortion or damage to the lining or coating. Any unit of pipe that, in the opinion of the County, is damaged beyond repair by the Contractor shall be removed from the site.

PART 2 - PRODUCTS

2.01 MATERIALS

A. Ductile Iron Pipe

1. Standards: ANSI A-21.50, AWWA C150 and ANSI A-21.51, AWWA C151
2. Thickness/Pressure Class:
 - a. Below ground piping: Class 350 (4-inch to 12-inch), Class 250 (16-inch to 24-inch) and Class 200 (30-inch to 64-inch) unless otherwise noted or specified.
 - b. Above ground piping: Flanged, Class 350 (minimum) unless otherwise noted or specified.
3. Joints
 - a. Push-on or Mechanical Joints (below ground piping)
 - (1) Standards: ANSI A21.11, AWWA C111
 - (2) Class: 350-psi working pressure rating
 - (3) Gaskets
 - (a) Potable and Reclaimed Water Service: Styrene Butadiene Rubber (SBR) ring type.
 - (b) Wastewater Service: Neoprene rubber ring type.
 - b. Flanged (above ground or inside below ground vaults)
 - (1) Standards: ANSI A21.15, ANSI B16.1
 - (2) Class: 125-pound factory applied screwed long hub flanges, plain faced without projection.
 - (3) Gaskets
 - (a) Spans less than 10-feet: full-face 1/8-inch thick neoprene rubber
 - (b) Spans greater than 10-feet: Toruseal gaskets as manufactured by American Cast Iron Pipe or acceptable equal.
 - c. Restrained Joints
 - (1) Manufacturers: Lok-Ring system (all sizes) or locking type gasket systems (for 16-inch diameter and smaller) as manufactured by American Ductile Iron Pipe; MEGALUG System as manufactured by EBBA Iron; or acceptable equal.
 - (2) Class: 250-psi minimum design pressure rating.
 - (3) Standard mechanical joint retainer glands shall not be acceptable.
 - d. Joint Accessories
 - (1) Mechanical joint bolts, washers and nuts: Ductile iron or Corten steel.
 - (2) Flanged joint bolts, washers and nuts: 316 stainless steel with bolts and nuts conforming to ASTM A193 Grade B8M.
 - e. Pipe Length (below ground installation): 20-foot maximum nominal length.
4. Pipe Identification
 - a. Each length of pipe shall bear the name or trademark of the manufacturer, the location of the manufacturing plant, and the class or strength classification of the pipe. The markings shall be plainly visible on the pipe barrel. Pipe which is not clearly marked is subject to rejection. The Contractor shall remove all rejected pipe from the project site within five NORMAL WORKING DAYS.

B. Fittings

1. Ductile iron fittings 4-inch through 24-inch shall be pressure rated at 350-psi minimum, except flanged joint type fittings which shall be rated at 250-psi minimum. All 30-inch and larger fittings shall be pressure rated to 250-psi minimum. All fittings shall conform to either ANSI/AWWA C110/A21.10 and/or C153/A21.53, latest revision, and shall be ductile iron only. All fittings shall be cast and machined allowing the bolt holes to straddle the vertical centerline. All fittings shall be designed to be capable to withstand, without bursting, hydrostatic tests of three times the rated water working pressure. All fittings shall have a date code cast (not printed or labeled) with identification of date, factory, and the factory unit from which it was cast and machined. Fittings shall have the pressure rating, nominal diameter of openings, manufacturer's name, and the country where cast and number of degrees or fraction of the circle distinctly cast on them. Ductile iron fittings shall have the letter "DI" or "Ductile" cast on them.
2. Joints shall be as described for ductile iron pipe for above ground/exposed and buried service.
3. All potable water main fittings shall have NSF 61 certification, and ISO 9001 certification for both the foundry and manufacturer. The NSF 61 certification shall be issued on all coatings and linings, from the said manufacturers that are used for potable water applications.

2.02 COATINGS, LININGS AND IDENTIFICATION MARKINGS

A. Exterior Coatings

1. Below ground/buried or in a casing pipe:
 - a. Type: Asphaltic coating, 1.0-mil DFT in accordance with ANSI/AWWA A21.51/C151.
 - b. Markings: (continuous 3-inch wide strip within top 90 degrees of pipe - min. drying time 30-minutes before backfill).
 - c. Color:
 - (1) Raw Wastewater: Safety Green
 - (2) Reclaimed Water: Purple (Pantone 522C)
 - (3) Potable Water: Safety Blue
2. Above ground/Exposed/In vaults
 - a. Coatings and coating testing for ductile iron pipe and fittings for above ground/exposed applications shall be accordance with Division 9. Primer, intermediate and final coats whether shop or field applied shall be compatible and applied in accordance with the coating system manufacturer's recommendations. Refer to Appendix D "List of Approved Products" for approved coating system suppliers. Asphaltic seal coat applied to the exterior of above ground piping and fittings shall be blasted and completely removed prior to coating per NACE-3/SSPC-SP6 commercial blast cleaning minimum angular anchor profile of 1.5-mils.

- b. Color
 - (1) Raw Wastewater: Safety Green
 - (2) Reclaimed Water: Purple (Pantone 522C)
 - (3) Potable Water: Safety Blue
 - 3. Inside Wetwell
 - a. All piping inside of wastewater wetwell shall be 316 stainless steel.
- B. Interior Lining (Applied by pipe manufacturer)
- 1. Wastewater: Interior coating shall be Protecto 401 (amine cured novalac epoxy containing at least 20% by volume of ceramic quartz pigment) for all pipe and fittings. All ductile iron pipe and fittings shall be delivered to the manufacturer certified applicator without asphalt, cement lining, or any other lining on the interior surface and no coating shall have been applied to the first 6-inches of the exterior of the DIP spigot ends. Minimum surface preparation shall be SSPC-SP 1 Solvent Cleaning method to remove oil and grease followed by NACE-4 / SSPC-SP7 Brush-Off Blast Cleaning. Protecto 401 shall be applied within 12-hours of surface preparation to the interior of the pipe and fittings so as to obtain a continuous and relatively uniform and smooth integral lining with a total minimum dry film thickness of 40-mils for the complete system. No lining shall take place when the substrate or ambient temperature is below 40°F. The lining shall not be used on the face of the flange of fittings or flanged pipe. The system shall be holiday free and holiday testing (minimum 2000 volts) shall be conducted and pinholes shall be repaired prior to shipping.
 - 2. Potable Water and Reclaimed Water: Interior coating shall be fusion-bonded epoxy (FBE) or Cement Mortar lined with asphaltic seal coat.
 - a. FBE for Fittings: Fittings shall be supplied with a FBE coating, both inside and outside for total protection including flanged and buried fittings. The exterior of flanged fittings for above ground assemblies shall adhere to final exterior coating requirements per 3119 2.04 A. The FBE coating system shall meet or exceed ANSI/AWWA C-550 and C116/A21.116 requirements and shall have NSF 61 certification. FBE coating thickness shall be 6 to 8-mils dry film thickness, shall be applied for secure adhesion, shall have a smooth surface and shall be holiday free.
 - b. Cement mortar lining with a seal coat of asphaltic material shall be in accordance with ANSI/AWWA A21.4/C104.
- C. Polyethylene Encasement is required when pipe is within 10-feet of a gas main or as indicated on the Drawings:
- 1. Standard: ANSI A 21.5/AWWA C105, 8-mil minimum thickness.

2.03 LOCATION MARKERS AND LOCATION WIRE

A. Electronic Markers and Locator System (for reclaimed water and wastewater ONLY)

1. Markers: Markers shall consist of a passive device capable of reflecting a specifically designated repulse frequency tuned to the utility (service) being installed. Markers shall be color coded in accordance with American Public Works Association's "Utility Locating and Coordinating Council Standards." Colors shall be: Wastewater and Reclaimed Water - #1404 Green. Markers shall be full range. Markers shall be installed directly above the centerline of the respective pipeline at intervals not to exceed 100-feet, at each fitting (tees, wyes, crosses, reducers, plugs, caps and bends) or change in horizontal direction and at each valve along the pipeline. Markers shall be hand backfilled to 1-foot above the pad and have a finished depth of burial of not less than 2-feet or more than 6-feet. No separate payment shall be made for furnishing and installing the respective frequency and color-coded electronic pad type marker.
2. Locator System: Marker locator set shall be the Scotch Mark EM II Electronic Marker Locator Path Tracing Receiver, or acceptable equal. The Contractor shall furnish 1-locator set for each type of service piping installed on the project (i.e.: reclaimed water, wastewater) to the County. Each unit shall incorporate the following features and accessories:
 - a. Unit(s) shall be tuned to the proper frequency for each type (service) of piping.
 - b. Field strength meter that provides visual indication of the return signal.
 - c. Function switch for selection of operation mode.
 - d. Sensitivity control to adjust the receiver gain.
 - e. Audio speaker for signal response.
 - f. Battery access panel containing condensed operating instructions.
 - g. Auxiliary headset and heads set jack.
 - h. Permanently attached shoulder straps.
 - i. Rugged shockproof and weatherproof storage/carrying case.
3. Manufacturer: System shall be Scotch Mark Locator System, or acceptable equal.

B. Location Detection Wire

1. Materials: Continuous, insulated 10-gauge copper wire (color to match pipe identification).
2. Installation: Directly above (1-inch maximum) centerline of pipe terminating at top of each valve box collar and be capable of extending 12-inches above top of box (stored inside the 2-inch brass pipe through the valve box collar) in a manner so as not to interfere with valve operation. For direction drilling installations, a minimum of 2 (two) 10-gauge wires shall be pulled along with the pipe.
3. Continuity: Continuity of wire to be tested using Metrotech 810/9860 or acceptable equal.

PART 3 - EXECUTION

3.01 INSTALLATION

- A. Ductile iron pipes shall be installed in accordance with AWWA C600 and AWWA Manual M-42. When a restraining type gasket is used, the bell shall be painted red.
- B. Underground Ductile Iron Pipe and Fittings.
 - 1. Bedding firm, dry and even bearing of suitable material. Blocking under the pipe will not be permitted.
 - 2. Placement
 - a. Alignment: In accordance with lines and grades shown on the Drawings. Deflection of joints shall not exceed 75% of the values recommended by the pipe manufacturer.
 - b. The Contractor shall provide line and grade stakes at a 100-foot maximum spacing and at all line and/or grade change locations. The Contractor shall provide temporary benchmarks at a maximum of 1,000-foot intervals. The minimum pipe cover shall be 30-inches below the finished grade surface or 30-inches below the elevation of the edge of pavement of the road surface whichever is greater.
 - c. All pipe and fittings shall be inspected prior to lowering into trench to insure no cracked, broken or otherwise defective materials are being used. All homing marks shall be checked for the proper length so as to not allow a separation or over homing of connected pipe. Homing marks incorrectly marked greater than 1-inch shall result in rejection of pipe and removal from site. The Contractor shall clean ends of pipe thoroughly and remove foreign matter and dirt from inside of pipe and keep clean during and after installation.
 - d. Proper implements, tools and facilities shall be used for the safe and proper protection of the Work. Pipe shall be lowered into the trench in such a manner as to avoid any physical damage to the pipe. Pipe shall not be dropped or dumped into trenches under any circumstances.
 - e. Trench Dewatering and Drainage Control: Contractor shall prevent water from entering trench during excavation and pipe-laying operations to the extent required to properly grade the bottom of the trench and allow for proper compaction of the backfill. Pipe shall not be laid in water.
 - f. Pipe Laying in Trench: Dirt or other foreign material shall be prevented from entering the pipe or pipe joint during handling or laying operations and any pipe or fitting that has been installed with dirt or foreign material in it shall be removed, cleaned and re-laid. Pigging of pipe may be used to remove foreign materials in lieu of flushing. At times when pipe installation is not in progress, the open ends of the pipe shall be closed by a watertight plug or by other means approved by the County to ensure absolute cleanliness inside the pipe. The pipe shall be installed with the color stripe and pipe text on the top of pipe.

3. Cutting: When required, cutting shall be done by machine, leaving a smooth cut at right angles to the axis of the pipe. Cut ends of the pipe to be used with a push-on bell shall be beveled. Bare metal exposed at ends of the pipe shall be field coated in accordance with pipe manufacturer's recommendations. Cut pipe for wastewater service shall have exposed bare metal ends repaired with Protecto 401 using the coating system manufacturer's field repair kit.

4. Joints

- a. Joint Placement

- (1) Push on joints: Pipe shall be laid with the bell facing upstream. The gasket shall be inserted and the joint surfaces cleaned and lubricated prior to placement of the pipe. After joining the pipe, a metal feeler shall be used to verify that the gasket is correctly located.
 - (2) Mechanical Joints: Pipe and fittings shall be installed in accordance with the "Notes on Method of Installation" under ANSI A21.11/AWWA C111. The gasket shall be inserted and the joint surfaces cleaned and lubricated with soapy water before tightening the bolts to the specified torque.

- C. Thrust Restraint

1. General: Thrust restraint shall be accomplished by the use of mechanical restraining devices unless specifically identified otherwise on the Drawings or herein.
 2. Length of Restrained Joints: In accordance with the lengths listed in the table as shown on the Drawings.

- D. Installation of Pipes on Curves

1. Maximum deflections at pipe joints, fittings and laying radius for the various pipe lengths shall not exceed 75% (percent) of the pipe manufacturer's recommendation.

3.02 CLEANING AND FIELD TESTING

- A. General: At the conclusion of the Work, the Contractor shall provide all associated cleaning and field testing as specified in other related sections of these specifications.

END OF SECTION

SECTION 15064
POLYVINYL CHLORIDE (PVC) PIPE AND FITTINGS

PART 1 - GENERAL

1.01 DESCRIPTION

- A. Scope of Work: Furnish all labor, materials, equipment and incidentals required and install and test all polyvinyl chloride (PVC) piping, fittings and appurtenances as shown on the Drawings and specified herein.
- B. General Design: The equipment and materials specified herein are intended to be standard types of PVC pipe and ductile iron fittings for use in transporting wastewater, reclaimed water, and water.

1.02 QUALITY ASSURANCE

- A. Qualifications: All of the PVC pipe and ductile iron fittings shall be furnished by manufacturers who are fully experienced, reputable, and qualified in the manufacture of the materials to be furnished. The pipe and fittings shall be designed, constructed, installed in accordance with the best practices and methods and shall comply with these specifications as applicable.
- B. Standards:
 - 1. AWWA C900/C905
 - 2. ASTM D1784 / D1785 / D2241 / D2466 / D2564 / D2729 / D2774 / D3034 / D3139 / D3212
 - 3. NSF 14
 - 4. UNI-B-1 through 5
- C. Factory Tests: The manufacturer shall perform the factory tests described in Section 3 - AWWA C900/C905.
- D. Quality Control:
 - 1. The manufacturer shall establish the necessary quality control and inspection practice to ensure compliance with the referenced standards.
 - 2. In addition to the manufacturer's quality control procedures, the County may select an independent testing laboratory to inspect the material at the production facility for compliance with these specifications. The County will pay for the cost of facility inspection requested by the County.

1.03 SHOP DRAWINGS AND SUBMITTALS

- A. Submittals shall be submitted to the County/Professional for review and acceptance prior to construction in accordance with the General Conditions and specifications Section 01300 "Submittals."
- B. Materials and Shop Drawings
- C. Manufacturer's Certification
 - 1. Submit sworn certification of factory tests and their results.

1.04 PRODUCT DELIVERY, STORAGE AND HANDLING

- A. Delivery and Storage: Delivery and storage of the materials shall be in accordance with the manufacturer's recommendations. PVC pipe shall be covered with black plastic with a minimum thickness of 15-mil. Joint gaskets shall be stored in a clean, dark and dry location until use.
- B. Handling: Care shall be taken in loading, transporting and unloading to prevent damage to the pipe or fittings and their respective coatings. Pipe or fittings shall not be rolled off the carrier or dropped. Pipe shall be unloaded by lifting with a forklift or crane. All pipe or fittings shall be examined before installation and no piece shall be installed which is found to be defective. Pipe shall be handled to prevent damage to the pipe or coating. Accidental damage to pipe or coating shall be repaired to the satisfaction of County or it shall be removed from the job. When not being handled, the pipe shall be supported on timber cradles or on level ground, graded to eliminate all rock points and to provide uniform support along the full pipe length. When being transported, the pipe shall be supported at all times in a manner to prevent distortion or damage to the lining or coating. Any unit of pipe that, in the opinion of the County, is damaged beyond repair by the Contractor shall be removed from the site.
- C. The Contractor shall be responsible for all materials furnished and stored until the date of project completion. The Contractor shall replace, at his expense, all materials found to be defective or damaged in handling or storage. The Contractor shall, if requested by the County, furnish certificates, affidavits of compliance, test reports, samples or check analysis for any of the materials specified herein. All pipe delivered to project site for installation is subject to random testing for compliance with the designated specifications.

PART 2 - PRODUCTS

2.01 GENERAL

- A. All material supplied shall be one of the products specified in Appendix D "List of Approved Products" appended to these technical specifications.

2.02 MATERIALS

A. Polyvinyl Chloride (PVC) Pipe

1. Standards: AWWA C900/C905 and ASTM D1784/D3034/F679 (Gravity Sewer)
2. Compounds: Class 12454-A or Class 12454-B
3. PVC Gravity Pipe and Fittings: PVC gravity pipe (6-inch to 15-inch), shall conform to ASTM D3034, maximum SDR 35. PVC gravity pipe (18-inch to 36-inch), shall conform to ASTM F679 and uniform minimum "pipe stiffness" at 5% (percent) deflection shall be 46-psi. The joints shall be integral bell elastomeric gasket joints manufactured in accordance with ASTM D3212 and ASTM F477. Applicable UNI Bell Plastic Pipe Association standard is UNI B.
4. PVC Pressure Pipe and Fittings: All PVC pipe of nominal diameter 4 to 12-inches shall be manufactured in accordance with AWWA Standard C900 and greater than 12-inches shall be manufactured in accordance with AWWA Standard C905. The PVC pipe shall have a minimum working pressure rating of 100-psi and shall have a maximum dimension ratio of 18. Pipe shall be the same outside diameter as ductile iron pipe.
5. Dimension Ratio/Thickness: (unless otherwise shown on the Drawings)
 - a. Raw Wastewater:
 - (1) Pressure Systems: DR 18
 - (2) Gravity Systems: DR 35 (ASTM D3034) or PS 46 (ASTM F679)
 - b. Treated Wastewater: DR 18
 - c. Reclaimed Water: DR 18
 - d. Raw Water: DR 18
 - e. Potable Water: DR 18
 - f. Irrigation Piping: Schedule 40 or SDR 21
6. Joints:
 - a. Push-on integral bell elastomeric gasket joints:
 - (1) Standards: ASTM D3212/D3139/F477 and UNI-B-1
 - (2) Gaskets:
 - (a) Potable and Reclaimed Water Service: Styrene Butadiene Rubber (SBR) ring type.
 - (b) Wastewater Service: Neoprene rubber ring type.
 - (3) Pipe Markings: Pipes shall have a manufacturer's home-mark on the spigot. On field cut pipe, the Contractor shall provide home-mark on the spigot in accordance with manufacturer's recommendations.
 - b. Solvent weld (nominal diameter less than 4-inches):
 - (1) Standards: ASTM D2466/D2564
 - (2) Type: Slip Fitting Socket (tapered)
 - (3) Exclusions: Plastic saddle and flange joints will not be used.
 - c. Restrained Joints:
 - (1) Restrained joint devices shall be made specifically for PVC pipe and meet or exceed the requirements in ASTM F-1674.
 - (2) Manufacturers: Uni-flange mechanical joint restraints and bell restraints (for all sizes); Meg-a-lug system as manufactured by EBBA Iron (sizes 12-inches or less), or acceptable equal.
 - (3) Design pressure rating equal to or above test pressure as specified herein.

- d. Pipe Length:
 - (1) Pressure systems: 20-feet maximum nominal length
 - (2) Gravity systems: 13-feet minimum nominal length
- B. Fittings - Pressure Systems (nominal diameter 4-inches and greater):
 - 1. Materials: Ductile iron
 - 2. Joints: Mechanical Joint, Minimum 350-psi pressure rating
 - 3. Gaskets:
 - a. Water and Reclaimed Water Service: Styrene Butadiene Rubber (SBR) ring type
 - b. Wastewater Service: Neoprene rubber ring type
 - 4. Exclusions: Standard double bell couplings will not be acceptable where the pipe will slip completely through the coupling.
 - 5. All fittings shall conform to either ANSI/AWWA C110/A21.10 and/or C153/A21.53, latest revision, and shall be ductile iron.
 - 6. All fittings shall have a date code cast (not printed or labeled), with identification of the date, factory and unit at which it was cast and machined. Fittings shall have distinctly cast on them the pressure rating, nominal diameter of openings, manufacturer's name, the country where cast, and deflection angle. Ductile iron fittings shall have the letters "DI" or "Ductile" cast on them.
 - 7. All potable water main fittings shall have NSF certification and ISO 9001 certification for both the foundry and manufacturer. The NSF 61 certification shall be issued on all coatings and linings, from the said manufacturers that are used for potable water applications.
 - 8. All ductile iron fittings shall have exterior coatings, including markings and colors, and interior linings in conformance with Section 15062 "Ductile Iron Pipe and Fittings."
- C. Fittings - Pressure Systems (nominal diameter less than 4-inches)
 - 1. Material: Polyvinyl Chloride (PVC)
 - 2. Joints: Slip fitting tapered socket with solvent weld
 - 3. Solvent: Sure Guard 12 or acceptable equal
 - 4. Exclusions: Plastic saddle and flange joint fittings shall not be used

2.03 LOCATION MARKERS, LOCATION WIRE AND IDENTIFICATION MARKINGS

- A. Electronic Markers and Locator System (for reclaimed water and wastewater ONLY)
 - 1. Markers: Markers shall consist of a passive device capable of reflecting a specifically designated repulse frequency tuned to the utility (service) being installed. Markers shall be color coded in accordance with the American Public Works Association's "Utility Locating and Coordinating Council Standards." Colors shall be: Wastewater and Reclaimed Water - #1404 Green. Markers shall be full range. Markers shall be installed directly above the centerline of the respective pipeline at intervals not to exceed 100-feet, at each fitting (tees, wyes, crosses, reducers, plugs, caps and bends) or change in horizontal direction and at each valve along the pipeline. Markers shall be hand backfilled to 1-foot above the pad and have a finished depth of burial of not less than 2-feet or more than 6-feet. No separate payment shall be made for furnishing and installing the respective frequency and color-coded electronic pad type marker.

2. Locator System: Marker locator set shall be the 3M Dynatel 1420 or 3M Dynatel 1420E Electronic Marker System Marker Locator, or acceptable equal. The Contractor shall furnish 1 locator set for each type of service piping installed on the Project (i.e.: reclaimed water, wastewater.) to the County. Each unit shall incorporate the following features and accessories:
 - a. Unit(s) shall be tuned to the proper frequency for each type (service) of piping.
 - b. Field strength meter that provides visual indication of the return signal
 - c. Function switch for selection of operation mode
 - d. Sensitivity control to adjust the receiver gain
 - e. Audio speaker for signal response
 - f. Battery access panel containing condensed operating instructions
 - g. Auxiliary headset and heads set jack
 - h. Permanently attached shoulder straps
 - i. Rugged shockproof and weatherproof storage/carrying case
3. Manufacturer: System shall be Scotch Mark Locator System, or acceptable equal.

B. Location Detection Wire

1. Materials: Continuous, insulated 10-gauge copper wire (color to match pipe identification).
2. Installation: Directly above (1-inch maximum) centerline of pipe terminating at top of each valve box collar and be capable of extending 18-inches above top of box (stored inside the 2-inch brass pipe through the valve box collar) in a manner so as not to interfere with valve operation. For direction drilling installations, a minimum of 2 (two) 10-gauge wires shall be pulled along with the pipe.

C. Identification Markings:

1. Pipe furnished in solid color or white with color lettering as indicated below.
 - a. Lettering along top 90° (degrees) of pipe, minimum 3/4-inch in height with appropriate wording appearing 1 or more times every 21-inches along the entire length of the pipeline.
 - (1) Raw Wastewater: Safety Green
 - (2) Reclaimed Water: Purple (Pantone 522C)
 - (3) Potable Water: Safety Blue

PART 3 - EXECUTION

3.01 INSTALLATION

- A. Standards: AWWA C900/C905/UNI-B 3 and 4
- B. Underground Polyvinyl Chloride (PVC) Pipe and Fittings
 1. Bedding: Firm, dry and even bearing of suitable material. Blocking under the pipe will not be permitted.
 2. Placement/Alignment:
 - a. Installation shall be in accordance with lines and grades shown on the Drawings. For pressure systems, deflection of joints shall not exceed 75% of that recommended by the manufacturer.

- b. All pipe and fittings shall be inspected prior to lowering into trench to insure no cracked, broken or otherwise defective materials are being used. All homing marks shall be checked for the proper length so as to not allow a separation or over homing of connected pipe. Homing marks incorrectly marked on pipe shall result in rejection of pipe and removal from site. The Contractor shall clean ends of pipe thoroughly and remove foreign matter and dirt from inside of pipe and keep clean during and after installation.
- c. Proper implements, tools and facilities shall be used for the safe and proper protection of the Work. Pipe shall be lowered into the trench in such a manner as to avoid any physical damage to the pipe. Pipe shall not be dropped or dumped into trenches under any circumstances.
- d. Trench Dewatering and Drainage Control: Contractor shall prevent water from entering trench during excavation and pipe laying operations to the extent required to properly grade the bottom of the trench and allow for proper compaction of the backfill. Pipe shall not be laid in water.
- e. Pipe Laying in Trench: Dirt or other foreign material shall be prevented from entering the pipe or pipe joint during handling or laying operations and any pipe or fitting that has been installed with dirt or foreign material in it shall be removed, cleaned and re-laid. Pigging of pipe may be used to remove foreign materials in lieu of flushing. At times when pipe installation is not in progress, the open ends of the pipe shall be closed by a watertight plug or by other means approved by the County to ensure absolute cleanliness inside the pipe. The color stripe and pipe text shall be viewed from the top of pipe when installed. When installing PVC pipe, no additional joints will be installed until the preceding pipe joint has been completed and the pipe carefully embedded and secured in place.
- f. Locating Wire: Locating wire, for electronically locating pipe after it is buried, or installed by trenchless technology shall be attached along the length of and installed with the pipe. This is applicable to all sizes and types of pressure mains. At a minimum, the tracing wire is to be attached to the pipe with nylon wire ties. The wire itself shall be 10-gauge single strand solid core copper wire with non-metallic insulation. The insulation shall be color coded for the type of pipe being installed. Continuous continuity must be maintained in the wire along the entire length of the pipe run. Permanent splices must be made in the length of the wire using wire connectors approved for underground applications as listed in the uniform electric code handbook. The coiled wire shall extend to a minimum of 12-inches above the surface and be connected to a test station box at valve locations.
- g. PVC Pressure Pipe Installation and Training: PVC pipe shall be installed in accordance with standards set forth in the UNI-BELL "Handbook of PVC Pipe", AWWA C605, and AWWA Manual M-23. The pipe shall be laid by inserting the spigot end into the bell flush with the insertion line or as recommended by the manufacturer. At no time shall the bell spigot end be allowed to go past the "insertion line" or "homing mark" for pressure pipe applications and homing mark shall be visible.

- h. Field Cutting: PVC pipe can be cut with a handsaw or power driven abrasive disc making a square cut. The end shall be beveled with a beveling tool, wood rasp or power sander to the same angle as provided on the factory-finished pipe. The insertion line on the spigot shall be remarked to the same dimensions as the factory-marked spigot.
- i. All Contractor pipe crews utilizing PVC pressure pipe shall be trained on an annual basis by Uni-Bell in coordination with the County and attended by the manufacturer's representative of the respective approved Manufacturers in Appendix D "List of Approved Products." The Uni-Bell PVC training session will consist of proper handling, storage, installation, and compaction as well as County requirements regarding PVC pipe and deflection. Every person handling, installing or backfilling PVC pipe shall not be permitted to install County owned and / or maintained pipe without training.
- j. Approved manufacturers representatives (Appendix D "List of Approved Products"), not present at the hosted Uni-Bell training session or individuals of pipe crews not in attendance shall be trained on every project site. On-site project training shall be for each manufacturer of pipe utilized on-site, per crew and per project. Specifically each crewmember shall be trained on every project by every pipe manufactures representative regardless of previous on-site training. Every person handling, installing or backfilling PVC pipe shall not be permitted to install County owned and / or maintained pipe without training.
- k. PVC Gravity Pipe Installation: Gravity sewer pipe shall be installed to the homing mark, no tolerance. Any noticeable separation shall be removed and reinstalled. The homing mark may be disregarded to meet the maximum of 1-inch separation between bell and spigot requirement. Joints:
 - l. Joint Placement:
 - (1) Push on joints: Pipe shall be laid with the bell ends facing upstream. The gasket shall be inserted and the joint surfaces cleaned and lubricated prior to placement of the pipe. After joining the pipe, a metal feeler shall be used to verify that the gasket is correctly located.
 - (2) Mechanical Joints: Pipe and fittings shall be installed in accordance with the "Notes on Method of Installation" under ANSI A21.11/AWWA C111. The gasket shall be inserted and the joint surfaces cleaned and lubricated with soapy water before tightening the bolts to the specified torque.

C. Thrust Restraint

- 1. Thrust restraint shall be accomplished by the use of mechanical restraining devices unless specifically identified otherwise on the Drawings or herein.
- 2. Length of restrained joints shall be in accordance with the lengths listed in the table as shown on the Drawings.

D. Installation of Pipes on Curves:

- 1. No joint deflection or pipe bending is allowed in PVC pipe. The maximum allowable tolerance in the joint due to variances in installation is 0.75° (degrees) (3-inches per joint per 20-foot stick of pipe). No bending tolerance in the pipe barrel shall be acceptable. Alignment change shall be made only with sleeves and fittings.

3.02 CLEANING AND FIELD TESTING

- A. At the conclusion of the Work, the Contractor shall provide all associated cleaning and field testing as specified in associated sections of these specifications.

END OF SECTION

SECTION 15065
STAINLESS STEEL PIPE AND FITTINGS

PART 1 - GENERAL

1.01 DESCRIPTION

- A. Scope: This section specifies stainless steel pipe and fittings.
- B. Types of Service: Stainless steel piping specified in this Section shall be used for raw sewage discharge piping in the pump station wetwell.

1.02 QUALITY ASSURANCE

- A. References: This Section contains references to the following documents. They are a part of this Section as specified and modified. Where a referenced document contains references to other standards, those documents are included as references under this Section as if referenced directly. In the event of conflict between the requirements of this Section and those of the listed documents, the requirements of this Section shall prevail.

Reference	Title
ANSI B16.1	Cast Iron Pipe Flanges and Flanged Fittings Classes 25, 125, 250, and 800
ANSI B16.11.80	Forged Steel Fittings, Socket Welding and Threaded
ANSI B31.1	Power Piping
ANSI B36.19M	Stainless Steel Pipe
ASME Section IX (1989)	Boiler and Pressure Vessel Code; Welding and Brazing Qualifications
ASTM A182/A182M	Forged or Rolled Alloy-Steel Pipe Flanges, Forged Fittings, and Valves and Parts for High Temperature Service
ASTM A193/A193M	Alloy-Steel and Stainless Steel Bolting Materials for High Temperature Service
ASTM A194/A194M	Carbon and Alloy Steel Nuts for Bolts for High Pressure and High Temperature Service
ASTM A240	Heat-Resisting Chromium and Chromium Nickel Stainless Steel Plate, Sheet, and Strip for Pressure Vessels
ASTM A276	Stainless and Heat-Resisting Steel Bars and Shapes
ASTM A312/A312M	Seamless and Welded Austenitic Stainless Steel Pipes
ASTM A320/A320M	Alloy Steel Bolting Materials for Low Temperature Service
ASTM A403/A403M	Wrought Austenitic Stainless Steel Piping Fittings
ASTM A409/A409M	Welded Large Diameter Austenitic Steel Pipe for Corrosive or High Temperature Service

ASTM A480/A480M	General Requirements for Flat-Rolled Stainless and Heat-Resisting Steel Plate, Sheet and Strip
ASTM A774/A774M	As-Welded Wrought Austenitic Stainless Steel Fittings for General Corrosive Service at Low and Moderate Temperatures
ASTM A778	Welded, Un-annealed Austenitic Stainless Steel Tubular Products

- B. Qualifications: All shop fabricated stainless steel pipe and fittings shall be furnished by a single manufacturer who is experienced and qualified in the manufacture and fabrication of the items to be furnished. The pipe and fittings shall be shop-fabricated and field-installed in accordance with common industry wide practices and methods and shall comply with these specifications. Only weld procedures which have been qualified under ASME Section IX and only welders who have successfully completed performance qualification tests per ASME Section IX on these qualified procedures shall be utilized.
- C. Testing: Factory testing shall conform to the requirements of ASTM A312, ASTM A409 HT-0, or ASTM A778, depending on the size and type of stainless steel pipe provided.

1.03 SHOP DRAWINGS AND SUBMITTALS

- A. Submittals shall be submitted to the County/Professional for review and acceptance prior to construction in accordance with the General Conditions and specifications Section 01300 "Submittals."
- B. Shop fabrication drawings showing details of materials, piping, fittings, couplings, dielectric connections, joint locations and details, and types and locations of supports.
- C. Certifications specified in the following documents:
 1. ASTM A403, paragraph 14.1
 2. ASTM A774, paragraph 14.1
 3. ASTM A778, paragraph 14.1
 4. ASTM A409, paragraph 17.1
- D. Test results as specified in this Section.
- E. Names and qualification records of proposed welders.
- F. Other data necessary to show conformance of the piping system to these specifications.

PART 2 - PRODUCTS

2.01 GENERAL

- A. All material supplied shall be one of the products specified in Appendix D "List of Approved Products" appended to these technical specifications.

2.02 PIPE

- A. Unless otherwise specified, stainless steel piping 3-inches and larger shall be manufactured from ASTM A240 annealed and pickled sheets and plates, Type 316L, in accordance with ASTM A778 or ASTM A409 HT-0. Only extra-low carbon (ELC) materials with 0.030% maximum carbon shall be used. Pipe shall be manufactured to nominal pipe sizes as listed in ANSI B36.19 and shall have nominal wall thickness corresponding to schedule 40S.

2.03 FITTINGS

- A. Unless otherwise specified, stainless steel fittings 3-inch and larger shall be butt weld type manufactured in accordance with ASTM A774 of the same material and in the same thicknesses as the pipe. Long radius elbows less than 24-inches in diameter shall be smooth flow. All short radius, special radius, reducing, and long radius elbows 24-inches and greater in diameter shall be of mitered construction. Reducers shall be straight tapered cone type. Tees, crosses, laterals, and wyes shall be shop-fabricated from pipe.

2.04 FLANGED CONNECTIONS

- A. Connections shall be flanged as specified in Section 15062 "Ductile Iron Pipe and Fittings" and be capable of being mated to ductile iron pipe flanges or pump base elbow.

2.05 GASKETS

- A. Gaskets shall be as specified in Section 15062 "Ductile Iron Pipe and Fittings."

2.06 BOLTS

- A. Bolts, nuts, and washers for stainless steel flange assemblies shall be Type 316 stainless steel with bolts and nuts conforming to ASTM A193 Grade B8M.

2.07 PIPE SUPPORT SYSTEMS

- A. Unless otherwise specified, all hangers, rods, structural attachments, and other components of support systems for stainless steel pipe shall be of the same materials as the pipe.

2.08 FINISH

- A. After all shop operations have been completed, pipe and fittings shall be pickled and passivated in the manufacturer's plant, and scrubbed and washed until discoloration and possible iron picked up from manufacturing process are removed. The standard finish for 16-gauge through 8-gauge material shall be No. 1 or 2B per ASTM A480; 3/16-inch and heavier plate material shall be No. 1-mil finish or better per ASTM A480.

PART 3 - EXECUTION

3.01 PIPE CUTTING, THREADING, AND JOINTING

- A. Pipe cutting, threading, and jointing shall conform to the requirements of ANSI B31.1. All pipe threads shall be lubricated with Teflon tape.

3.02 WELDING

- A. General: Piping with wall thickness up to 11-gauge (0.120-inch) shall be welded with the TIG (GTAW) process. Unless otherwise specified, heavier walls shall be properly beveled and have a root pass with the TIG (GTAW) process followed by subsequent passes with the TIG (GTAW), MIG (GMAW), or Metallic Arc (SMAW) process. Filler wire of ELC grades only shall be added to all welds to provide a cross section at the weld equal to or greater than the parent metal. Weld deposit shall be smooth and evenly distributed and have a crown of no more than 1/16-inch on the I.D. and 3/32-inch on the O.D. of the piping. Concavity, undercut, cracks, or crevices shall not be allowed. Butt welds shall have full penetration to the interior surface, and inert gas shielding shall be provided to the interior and exterior of the joint. Excessive weld deposits, slag, spatter, and projections shall be removed by grinding. Welds on gasket surfaces shall be ground smooth.
- B. Field Welding: Field welding shall be minimized to the greatest extent possible by prefabrication of pipe systems at the factory. Pipe butt welds may be performed at the job site providing the butt welds are performed only with an inert gas shielded process and that other applicable specified welding requirements are rigidly adhered to. All residue, oxide, and heat stain is to be removed from any type of field weld and the affected adjacent areas by the use of stainless steel wire brushes. The field weld shall then be cleaned with an agent such as Eutectic Company's "Eucleen" or equal followed by complete removal of the agent.
- C. Preparation of Surfaces to Be Welded: Surfaces of joints to be welded shall be free from mill scale, slag, grease, oil, paint, rust, and other foreign material. Joints to be welded shall be wire-brushed with stainless steel wire brushes and precisely fitted before welding.
- D. Weather Conditions: Welding shall be done only when the surfaces are completely free of any moisture. Welding of the pipe shall not be done during periods of high winds or rain unless the areas being welded are properly shielded.
- E. Tack Welds, Clips, and Other Attachments: Nicks, gouges, notches, and depressions in the base metal in the area of the joint shall be repaired before the joint weld is made. Tack welds, clips, and other attachments shall be removed and defects repaired, except where the tack welds occur within the weld area and these tack welds do not exceed the size of the completed weld. Cracked tack welds shall be removed. Areas to be repaired shall be ground to clean metal and then repaired by building up with weld metal. The repaired areas shall be ground smooth to form a plane surface with the base metal.

- F. Defects and Repairs: Welds with cracks, slag inclusions, porosity, undercutting, incomplete penetration, or which are otherwise deficient in quality or made contrary to any provisions of these specifications shall be removed by chipping or grinding throughout their depth to clean base metal. Calking or peening of welds to correct defects shall not be done. Welds found deficient in dimension but not in quality shall be enlarged by additional welding after thoroughly cleaning the surface of previously deposited metal and the adjoining plate. Weld deposits, slag, weld spatter, and projections into the interior of the pipe shall be removed by grinding.

3.03 MARKING, SHIPPING, AND STORAGE

- A. Pipe, fittings, and fabrications shall be properly marked with type, gauge, and heat number. Fabricated piping shall have openings plugged and flanges secured for storage or transport after fabrication. Fabricated piping shall be piece-marked with identifying numbers or codes which correspond to the Contractor's layout and installation drawings. The marks shall be located on the spools at opposite ends and 180° (degrees) apart. Pipe spools shall be loaded, blocked, and lagged as necessary to ensure protection from damage during shipping. Stainless steel pipe and fittings shall be stored per manufacturer's recommendation. Dents, gouges, and scratches in stainless steel pipe and fittings are not acceptable and are reason for rejecting pipe and fittings.

3.04 FABRICATION/INSTALLATION REQUIREMENTS

- A. The piping supplier and the Contractor shall use extreme care to avoid the contact of any ferrous materials with the stainless steel piping during manufacturing, fabricating, handling, and installation stages. All saws, drills, files, and wire brushes shall be used for stainless steel piping only. Pipe storage and fabrication racks shall be nonferrous, stainless steel, or rubber-lined. Nylon slings or straps shall be used for handling stainless steel piping. After installation, the Contractor shall wash and rinse all foreign matter from the piping surface. All welded joints shall be treated with a pickling solution, brushed with stainless steel wire brushes, and rinsed clean. If rusting of embedded iron occurs, the Contractor shall pickle the affected surface with Oakite Deoxidizer SS, or equal, scrub with stainless steel brushes, and rinse clean.

3.05 COATINGS

- A. Painting of the stainless steel pipe is not required.

END OF SECTION

THIS PAGE LEFT BLANK INTENTIONALLY

SECTION 15100
ANCILLARY EQUIPMENT

PART 1 - GENERAL

1.01 DESCRIPTION

- A. Scope of Work: Provide all valves and appurtenances, ready for operation, as shown on the Drawings and as specified herein.

1.02 QUALITY ASSURANCE

- A. All valves, appurtenances, and ancillary equipment shall be products of well-established reputable firms who are fully experienced, reputable and qualified in the manufacture of the particular equipment to be furnished. The equipment shall be designed, constructed, and installed in accordance with the best practices and methods and shall comply with these Specifications.

1.03 SHOP DRAWINGS AND SUBMITTALS

- A. Submittals shall be submitted to the County for review and acceptance prior to construction in accordance with the General Conditions and specifications Section 01300 "Submittals."

PART 2 - PRODUCTS

2.01 GENERAL

- A. All valves, appurtenances, and ancillary equipment shall be of the sizes shown on the Drawings and specified herein.
- B. All valves and appurtenances shall have the name of the maker and the working pressure for which they are designed cast in raised letters upon some appropriate part of the body.
- C. All valves, appurtenances, and ancillary equipment shall be as specified in Appendix D "List of Approved Products" appended to these technical specifications.

2.02 AIR RELEASE VALVES

- A. For Water Service and Reclaimed Water Service
 - 1. General: Water mains shall be equipped with combination air release valves located as shown on the Drawings. Valves shall be made to remove air at high points where elevation changes exceed 5-feet. Automatic air release valves shall be located at high points for pipe systems greater than 12-inches in diameter.

2. Water and Reclaimed Water Combination Air Release Valves: The valve body shall be 316 stainless steel, 316 stainless steel float, bronze water diffuser Buna-N or Viton seat and stainless steel trim.
3. Fittings from the main to the air release valve shall be threaded and made of brass.

B. For Wastewater Service

1. General: Wastewater force mains shall be equipped with combination air release valves located as shown on the Drawings. Valves shall be made to remove air at high points where elevation change is 2-feet or greater, located in an enclosure as detailed on the Drawings.
2. Wastewater Combination Air Release Valves: The valve body shall be conical in shape and shall be 316 stainless steel with a funnel shape lower body to automatically drain sewage back into the system. All internal parts shall be corrosion resistant 316 stainless steel or non-metallic plastic materials.
3. On flanged connections 316 stainless steel bolts, nuts and washers are to be used along with the proper sized gasket.

C. Air release valves shall be installed in an enclosure.

2.03 TAPPING SLEEVES AND VALVES

A. General: Tapping sleeves shall be mechanical joint sleeves.

B. Mechanical Joint Sleeves: Sleeves shall be cast of gray-iron or ductile-iron and have an outlet flange with the dimensions of the Class 125 flanges shown in ANSI B16.1 and properly recessed for tapping valve. Glands shall be gray-iron or ductile iron. Gaskets shall be vulcanized natural or synthetic rubber. Bolts and nuts shall comply with ANSI/AWWA C111/ANSI A21.11. Sleeves shall be capable of withstanding a 200-psi working pressure.

C. Fabricated Mechanical Joint Tapping Sleeves: Sleeves shall be of split mechanical joint design with separate end and side gaskets. Sleeves shall be fabricated of high strength steel, meeting ASTM A283 Grade C or ASTM A-36. Outlet flange shall meet AWWA C-207, Class "D" ANSI 150-pound drilling and be properly recessed for the tapping valve. Bolts and nuts shall be high strength low alloy steel to AWWA C111 (ANSI A21.11). Gasket shall be vulcanized natural or synthetic rubber. Sleeve shall have manufacturer applied fusion-bonded epoxy coating, minimum 12-mil thickness.

D. Tapping Valves: Tapping valves shall be resilient seated gate valves flange by mechanical joint ends. Valves shall be compatible with tapping sleeves as specified above and specifically designed for pressure connection operations.

1. Tapping valves with alignment lip shall be placed vertical where possible for Water and Reclaimed Water.

2. Tapping Valves 16-inch and larger shall be AWWA C515 resilient seated only (16-inch and 24-inch no gearing required) above 24-inch shall be installed vertically with a spur gear actuator. When tapping existing mains, valves 24-inch and above shall be furnished with NPT pipe plugs for flushing the tracks.

2.04 VALVE BOXES FOR BURIED VALVES

- A. Standard 2-piece Cast Iron Valve Box: Required for mains less than 6-feet below finished grade and less than or equal to 12-inches in diameter.
 1. Valve boxes shall be provided with suitable heavy bonnets and shall extend to such elevation at or slightly above the finished grade surface as directed by the County's Representative.
 2. The barrel shall be 2-piece, screw type only, having 5-1/4-inch shaft. The upper section shall have a flange at the bottom having sufficient bearing area to prevent settling and shall be complete with locking cast iron covers. Coat buried cast iron pieces with coal tar epoxy.
- B. Valve Box Assembly: Valve box assemblies with operating nut extension is required for any size main that is 6-feet or greater below finished grade or if mains are greater than 12-inches in diameter.
 1. Valve boxes shall be 1 complete assembled unit composed of the valve box and extension stem that attaches and locks to the 2-inch wrench nut. The extension shall be high strength, corrosion resistant steel construction, and permanently attached to the operating nut.
 2. The operating nut extension insert shall be 1 complete assembled unit with a self-adjusting extension stem system that fits inside a standard valve box that will accommodate variable trench depths 6-feet and greater as shown in the Drawings. All moving parts of the extension stem shall be enclosed in a housing to prevent contact with the soil.
 3. A valve box-centering device designed to eliminate the shifting of the valve box against the operating nut of the valve shall be used. Valve box assembly shall be adjustable to accommodate variable trench depths 6-foot and greater as shown in the Drawings.
- C. The stem assembly shall be of a telescoping design that allows for variable adjustment length. The material shall be at minimum galvanized square steel tubing. The stem assembly shall have a built-in device that prevents the stem assembly from disengaging at its fully extended length. The extension stem must be capable of surviving a torque test to 1,000-foot-pounds without failure.
- D. Valve boxes shall have locking cast iron covers utilizing a 5-sided nut with a special wrench needed to open. Covers shall have "WATER", "SEWER", or "RECLAIMED WATER" cast into the top, as applicable
- E. Concrete Collar: Each valve installed in an unimproved area (outside of pavement, driveways or sidewalks) shall require a 24-inch by 24-inch by 6-inch concrete pad or collar as shown in the Drawings.

- F. Identification Disc: Each 16-inch or larger valve (unless otherwise shown on the Drawings) installed shall be identified by a 3-inch diameter bronze disc anchored in the concrete pad or collar in unimproved areas and/or anchored on a 4-inch by 4-inch by 18-inch long concrete post set flush with the pavement surface in improved areas. The disc shall be stamped with the following information as shown on the Drawings:
 - 1. Size of the valve
 - 2. Type of valve
 - 3. Service
 - 4. Direction and number of turns to open
- G. Valve markers are to be made of schedule 80 PVC and have decal applied containing information as shown on the Drawings. The marker shall be the same color as the pipe being marked.

2.05 LINE STOPPING ASSEMBLIES

- A. Sleeves used to line-stop existing mains shall be provided and installed at locations as shown on the Drawings. Line-stopping sleeve shall be steel fusion epoxy coated body with stainless steel straps, bolts, nuts, and washers. Contractor shall determine the outside diameter of the existing main prior to ordering sleeve.
- B. The line-stopping equipment shall consist of a resilient sealing element, which shall be attached to and transported by a plug inserter perpendicularly into the pipe. The linear actuator shall extend and retract the Line-Stopper into and out of the pipe. When retracted from the pipe, the element and inserter shall be contained within the stopper housing.
- C. The hollow cylindrical sealing element shall be molded of natural rubber. The lower interior chamber of the element shall be enlarged into a hemispherical cavity to allow symmetrical deformation into sealing conformity with the bore of the pipe.
- D. The linear actuator shall be hydraulic and shall have a self-contained hand operated pump. The actuator shall exert a force sufficient to perpendicularly deform the cylindrical element into axially symmetrical sealing contact with the bore of the pipe. Design of actuator shall provide adequate stroke and means to continually align the line-stop bullet stopping assemblies in sizes 14-inch through 20-inch with pressure rating to 250-psig.
- E. Equalization of pressure across the sealed element shall not be required to retract the element from the pipe. No equalization fittings shall be required downstream of the line-stopper.
- F. The line-stopping equipment shall be accurately aligned on the 4-inch through 8-inch fittings by locating in the external threads of the fitting nozzle. With sizes 10-inch and 12-inch the location shall be made on the centering groove of the fitting flange.
- G. Line-stopping equipment must be capable of function and acceptance of multiple stopper heads and shall be compatible with existing system fittings.

2.06 FIRE HYDRANTS AND VALVE ASSEMBLIES

- A. Fire hydrants shall be 5-1/4-inch minimum valve opening and shall comply with the current AWWA Standard Specifications C502-54 for 150-psi working pressure. Fire hydrants shall be of ample length for 3-1/2-foot depth of bury with necessary extensions to place safety flange the required 3-inches above finished grade. Each hydrant shall be made in at least 2 sections bolted together. All interior working parts of the hydrant shall be removable from the top of the hydrant to allow repairs without removing the hydrant barrel after it has been installed. It shall be provided with 2 (two) 2-1/2-inch hose nozzles and 1 (one) 4-1/2-inch pumper nozzle, all having its specific Fire District Standard hose threads. All nozzles shall have caps attached by chains. Operating nuts shall be AWWA Standard. Drain or weep holes shall be permanently plugged by the manufacturer.
- B. Fire hydrant painting and coating shall meet the requirements of Section 09900 "Painting." Fire hydrants shall be painted silver in accordance with the present Orange County standards. Three (3) operating wrenches shall be furnished for every 10 hydrants installed or relocated.
- C. All hydrant assemblies shall incorporate anchoring hydrant fittings, including M.J. Locked Hydrant Tee with split gland to provide the locking together of the entire assembly. Gate valve shall be as specified in Specification Section 15111 "Plug Valves."
- D. All hydrants shall have a 24-inch to 48-inch square by 6-inch thick reinforced concrete shear pad as shown in the Drawings.
- E. Fire hydrants shall be located in the general location as shown on the Drawings. Final field location of all hydrants shall be as approved by the County. All hydrants shall be located no less than 5 and no more than 10-feet from the edge of pavement of the adjacent roadway and no less than 5-feet from any physical feature which may obstruct access or view of any hydrant unless otherwise approved by the County.

2.07 SERVICE SADDLES

- A. Stainless Steel Service Saddles: Shall be epoxy or nylon coated ductile iron body with stainless steel, 18-8 type 304 straps, AWWA tapered threads for 1-inch and 2-inch to be iron pipe threads. Controlled OD saddles to be used on C905 PVC pipe, double straps to be 2-inch minimum width each, single strap to be minimum of 3-inches wide.
- B. PVC Pipe Service Saddle
 1. One-inch and 2-inch services utilize brass body saddle with controlled OD for 12-inches and smaller pipe.
 2. One-inch and 2-inch taps on existing pipes larger than 12-inches shall use controlled OD epoxy or nylon coated ductile iron body with stainless steel 18-8 type 304 straps.
 3. Four-inch or larger services shall be mechanical tapping sleeves.
- C. Ductile Iron Pipe Service Saddle
 1. One-inch services shall be direct tapped.

2. Two-inch service shall use a controlled OD service tapping saddle with stainless steel straps and a ductile iron body that is either nylon or epoxy coated
3. Four-inch or larger services shall be mechanical tapping sleeves.

D. HDPE Pipe Service Saddle

1. One-inch and 2-inch shall utilize controlled O.D. tapping saddle with epoxy or nylon coated stainless steel 18-8 type 304 double straps.
2. Four-inch or larger, shall use wide body tapping sleeves with a broad cross section gasket set in a retaining groove that increases sealing capability as pressure increases.

E. Concrete Pressure Pipe Service Saddle

1. Tapped concrete pressure pipe shall be in accordance with AWWA M-9, using a strap-type saddle made specifically for concrete cylinder pressure pipe.

F. Steel Pipe Service Saddle

1. Welded-on steel sleeves shall be used for all sizes and applications.

2.08 CORPORATION STOPS AND CURB STOPS

- A. Corporation Stops: Shall be brass body reduced port type compatible with the polyethylene tubing and threaded in accordance with AWWA C800, AWWA C901, and shall comply with NSF-61.
- B. Curb Stops: Shall be brass body reduced port type compatible with the polyethylene tubing and threaded in accordance with AWWA C800, AWWA C901, and shall comply with NSF-61.

2.09 WATER MAIN AND RECLAIMED WATER MAIN SERVICE PIPE

- A. Polyethylene Service Pipe: One-inch and 2-inch service lines shall be polyethylene tubing conforming to AWWA C901 and AWWA C800. Tubing shall be approved for potable water use and bear the seal of the National Sanitation Foundation (NSF). The product shall be rated for a minimum working pressure of 150-psi and a (Dimension Ratio) DR-9 size. The tubing shall be designated copper tube size and the material PE-2406 cell classification minimum PE213323C in accordance with ASTM 3350.
- B. Ductile Iron Service Pipe: Services 4-inch and larger shall be DIP. If the existing main is on the same side of the street as the property to be serviced, the service pipe shall be DIP from the point of connection to the existing main to the meter assembly. If the existing main is on the opposite side of the street as the property to be serviced, at a minimum, the segment of pipe immediately upstream from the meter assembly shall be DIP.
- C. No service pipe shall terminate under a driveway.

2.10 PRESSURE GAUGES

- A. Pressure gauges shall be installed on each pump station discharge pipe as indicated on the Drawings.
- B. Pressure gauge shall be direct mounted, diaphragm (type) gauge, stainless steel case, stainless steel sensing element, liquid filled, with a 4-1/2-inch diameter dial and furnished with a clear glass crystal window and 1/4-inch shut-off (isolation) valve. Gauges shall be weatherproof.
- C. The pressure gauge face dial shall be white finished aluminum with jet-black graduations and figures and shall indicate the units of pressure measured in psi. Gauges shall be provided with pressure at normal operation at the mid range of the gauge.
- D. As wastewater flows through the housing, the cylinder shall transmit pressure through the sensing liquid. Gauge outlet in the spool or ring shall be threaded, 1/4-inch, per ANSI B2.1.
- E. Nipples for connecting gauges to piping shall be Schedule 80S, Grade TP 316 seamless stainless steel, conforming to ASTM A 312. Fittings shall conform to ASTM A 403, Class WP316. Threads shall conform to ANSI B2.1. Size of pipe nipple shall match the gauge connection size.

2.11 TIE RODS

- A. Steel for tie rods and tie bolts shall conform to the requirements of ASTM Designation A 242, and rods shall be galvanized in conformance with requirements of ASTM Designation A 123.

2.12 BACK FLOW PREVENTION

- A. Reduced Pressure Backflow Preventer shall conform to the requirements of ASSE 1013, rated to 180°F and supplied with full port ball valves. The main body and access covers shall be bronze and meet ASTM B 584, the seat ring and all internal polymers shall be NSF Noryl and the seat disc elastomers shall be silicone.
- B. Dual check valves shall be required and shall be accessible for maintenance without removing the relief valve or the entire device from the line.
- C. The bottom of the preventer shall be installed a minimum of 12-inches above grade and not more than 30-inches above grade.

2.13 FLANGED COUPLING ADAPTERS

- A. All adapters shall be harnessed with the bolts across the joint (flange to flange or flange to lug) designed for the pipe test pressure.

- B. Adapter Size: Conform in size and bolt hole placement to ANSI standards for steel and/or cast iron flanges 125 or 150-pound standard unless otherwise required for connections.
- C. Exposed Sleeve Type
 - 1. Material: Steel
 - 2. Coating: Enamel
 - 3. Bolting: Carbon steel
 - 4. Acceptable Manufacturers: Dresser Manufacturing Co. - Style 128 for cast iron ductile iron and steel pipes with diameters of 2-inches through 96-inches, or equal.
- D. Buried Sleeve Type
 - 1. Material: Cast iron
 - 2. Bolting: Type 304 stainless steel conforming to ASTM A 193, Grade B8 for bolts, and ATM A 194, Grade 8 for nuts and washers. Bolts and nuts greater than 1-1/8-inches shall be carbon steel, ASTM A 307, Grade B, with cadmium plating, ASTM A 165, Type NS.
 - 3. Acceptable manufacturers: Dresser Manufacturing Co. - Style 127 locking type for cast iron, ductile, iron, asbestos cement and steel pipes with diameters of 3-inches through 12-inches, or equal.
- E. Split Type
 - 1. Material: Malleable or ductile iron.
 - 2. Design: For use with grooved or shouldered end pipe.
 - 3. Coating: Enamel
 - 4. Acceptable Manufacturers: Victaulic Company of America - Style 741 for pipe diameters of 2-inches through 12-inches, Victaulic Company of America - Style 742 for pipe diameters of 14-inches through 16-inches, or equal.

PART 3 - EXECUTION

3.01 INSTALLATION

- A. All ancillary equipment shall be installed in the locations shown, true to alignment and rigidly supported. Any damage to the above items shall be repaired to the satisfaction of the County before installation.
- B. After installation, all ancillary equipment shall be tested as specified for adjacent piping. If any joint or equipment proves to be defective, it shall be repaired and retested to the satisfaction of the County.
- C. Install all floor boxes, brackets, extension rods, guides, the various types of operators and appurtenances as shown on the Drawings that are in masonry floors or walls, and install concrete inserts for hangers and supports as soon as forms are erected and before concrete is poured. Before setting these items, the Contractor shall check all plans and figures, which have a direct bearing on the location and shall be responsible for the proper location of these valves and appurtenances during the Construction of the structures.

D. Notification and Connections to Existing Mains

1. The Contractor shall submit a completed "System Connection" form to the County to schedule the connection. The request shall be made a minimum of 5-working days prior to the proposed tie-in to the existing main for pressure connections and 10-working days prior to the proposed tie-in to the existing main for non-pressure connections. In this request, the Contractor shall provide the following information:
 - a. Points of connection, fittings to be used and method of flushing and disinfection if applicable
 - b. Estimated construction time for said connections
 - c. Identify pressure and non-pressure connections
2. Connections shall only be made on the agreed upon date and time. If the Contractor does not perform the Work in the agreed upon manner or schedule, the Contractor shall be required to reschedule the connection by following the procedure outlined above.

E. Pressure Connections: Sufficient length of main shall be exposed to allow for installation of the tapping sleeve and valve and the operation of the tapping machinery. The main shall be supported on concrete pedestals or bedding rock at sufficient intervals to properly carry its own weight, plus the weight of the tapping sleeve, valve and machinery. Any damage to the main due to improper or insufficient supports will be repaired at the Contractor's expense.

1. Prior to the tap, the Contractor shall assemble all materials, tools, equipment, labor, and supervision necessary to make the connection.
2. The Contractor shall excavate a dry and safe working area pit of sufficient size to enable the necessary Work.
3. The inside of the tapping sleeve and valve, the outside of the main and the tapping machine shall be cleaned and swabbed or sprayed with 1% liquid chlorine solution prior to beginning installation for water system pressure connections and must comply with AWWA C-651-99 or most current version.
4. After the tapping sleeve has been mounted on the main, the tapping valve shall be bolted to the outlet flange, making a pressure tight connection. Prior to beginning the tapping operation, the sleeve and valve shall be pressure tested under the observation of County personnel to 150-psi for 30-minute duration to ensure that no leakage will occur.
5. For pressure connections 4-inch through 20-inch installation, the minimum diameter cut shall be 1/2-inch less than the nominal diameter of the pipe to be attached. For larger taps, the allowable minimum diameter shall be 2 to 3-inches less than the nominal diameter of the pipe being attached. After the tapping procedure is complete, the Contractor shall submit the coupon to the County.
6. The tapping valve shall be placed horizontally for pressure connections to wastewater force mains. A plug valve shall be attached to the tapping valve after the tapping procedure is complete. The tapping valve shall be left in the open position prior to backfilling.
7. Adequate restrained joint fittings shall be provided to prevent movement of the installation when test pressure is applied.
8. The Contractor shall be responsible for properly backfilling the work area pit after the Work is completed.

F. Non-Pressure Dry Connections

1. For water service connections, no customer shall be without service for more than 6-hours. For wastewater connections, provide bypass operations per Section 01516 "Collection System Bypass." This accommodation to customers may include scheduling after Normal Working Hours.
2. The Contractor shall be ready to proceed by pre-assembling as much material as possible at the site to minimize the length of service interruption.
3. Needed pipe restraints must be installed prior to the initiation of the shutdown.
4. The excavation shall be opened and needed site preparations must be completed before the initiation of the connection work.
5. County shall postpone a service cut-off if the Contractor is not ready to proceed at the scheduled time.
6. Only County personnel shall operate the valves needed to perform the shutdown on the existing system.

3.02 PAINTING

- A. All exterior surfaces of iron body valves shall be clean, dry, and free from rust and grease before coating.
- B. For valves installed underground or in valve vaults, all exterior ferrous parts of valve and actuator shall be coated at the factory with a thermally bonded epoxy coating in accordance with AWWA C550, latest revision.
- C. For aboveground service, the exterior ferrous parts of all valves shall be coated in weatherproof paint. The color of the finish coats shall be in accordance with the Orange County Utilities Standards.

END OF SECTION

SECTION 15105

CHECK VALVES

PART 1 - GENERAL

1.01 SCOPE OF WORK

- A. Scope of Work: Furnish, install, and test check valves including all appurtenances required as shown on the Drawings and as specified herein.
- B. General Design
 - 1. Valves larger than 2-1/2-inch diameter shall meet or exceed the requirements of AWWA C-508.
 - 2. All of the equipment and materials specified herein are intended to be standard for use in controlling the flow of sewage, water, sludge, chemicals, air, etc., depending on the applications.
 - 3. All valves and appurtenances shall have the name of the manufacturer and the working pressure for which they are designed cast in raised letters upon some appropriate part of the body.
 - 4. For all buried valves in which the operating nut is deeper than 4-feet from the finish ground surface, an extension rod with 2-inch operating nut and upper guide shall be installed permanently in the riser section. Extend nut to 1-foot below finish grade.

1.02 QUALITY ASSURANCE

- A. All gate valves of same type and style shall be manufactured by one manufacturer.
- B. All equipment furnished under this Specification shall be new and unused and shall be a standard product which has a successful record of reliable service in similar installations for a minimum of 5-years.

1.03 SHOP DRAWINGS AND SUBMITTALS

- A. Submittals shall be submitted to the County/Professional for review and acceptance prior to construction in accordance with the General Conditions and specifications Section 01300 "Submittals."
- B. Shop Drawings and submittals shall be submitted to the County/Professional Engineer for review and acceptance prior to construction for the following:
 - 1. Certified Shop Drawings showing details of construction, dimensions (including laying length), and weight.
 - 2. Descriptive literature, bulletins, and/or catalogs showing all valve parts and describing material of construction by material and specification, e.g., AISI.
 - 3. Valve coatings and linings, if any.
 - 4. A complete bill of materials for all equipment.

1.04 PRODUCT DELIVERY, STORAGE, AND HANDLING

A. Shipping

1. All parts shall be properly protected so that no damage or deterioration will occur during a prolonged delay from the time of shipment until installation is completed.
2. Factory assembled parts and components shall be dismantled for shipment unless permission is received in writing from the County/Professional Engineer.
3. Finished surfaces of all exposed openings shall be protected by wooden blanks, strongly built and securely bolted thereto.
4. Finished iron or steel surfaces not painted shall be properly protected to prevent rust and corrosion.
5. After hydrostatic or other tests, all entrapped water shall be drained prior to shipment, and proper care shall be taken to protect parts from the entrance of water during shipment, storage, and handling.
6. Each box or package shall be properly marked to show its net weight in addition to its contents.

B. Storage

1. Store valves and accessories in an area on the construction site protected from weather, moisture, or possible damage.
2. Do not store valves or accessories directly on the ground.

C. Handling

1. Handle valves and accessories to prevent damage of any nature.
2. Carefully inspect all materials for:
 - a. Defects in workmanship and materials
 - b. Removal of debris and foreign material in valve openings and seats
 - c. Proper functioning of all operating mechanisms
 - d. Tightness of all nuts and bolts

1.05 WARRANTY AND GUARANTEES

- A. The manufacturer's warranty period shall be concurrent with the Contractor's for 1-year, unless otherwise specified, commencing at the time of final acceptance by the County.
- B. The Contractor shall be responsible for obtaining certificates for equipment warranty for all equipment which lists for more than \$500.00 (major equipment). The County reserves the right to request warranties for equipment not classified as "major". The Contractor shall still warrant equipment not considered to be "major" in the Contractor's 1-year warranty period even though certificates of warranty may not be required.
- C. In the event that the equipment manufacturer or supplier is unwilling to provide a 1-year warranty commencing at the date of substantial completion, the Contractor shall obtain from the manufacturer a 2-year warranty commencing at the time of equipment delivery to the job site. This 2-year warranty from the manufacturer shall not relieve the Contractor of the 1-year warranty starting at the time of County acceptance of the equipment.

- D. The County shall incur no labor or equipment cost during the guarantee period.
- E. Guarantee shall cover all necessary labor, equipment, and replacement parts resulting from faulty or inadequate design, improper assembly or erection, defective workmanship and materials, leakage, breakage, or other failure of equipment or components furnished by the manufacturer.

PART 2 - PRODUCTS

2.01 MATERIALS AND EQUIPMENT

- A. Ball Check Valves, 2-1/2-inches and smaller.
 - 1. Valves shall be all bronze construction with screwed ends.
 - 2. Minimum valve working pressure shall be 150-psi.
 - 3. Valves shall be as manufactured by Crane, Watts, or equal.
- B. Rubber Flapper Swing Check Valves (Sewage/Sludge and Low Pressure Effluent Pumping Application; i.e., less than 50-psi).
 - 1. Valves shall have a cast iron body and cover meeting ASTM A126, Class B specifications.
 - 2. Flapper shall be Buna-N reinforced and shall be easily removed without any need to remove the valve from line.
 - 3. Ends shall be flanged, 125-pound ANSI B16.1. The flapper shall be Buna-N having an "O" ring seating edge and be internally reinforced with steel.
 - 4. Valve shall provide drip-tight shutoff.
 - 5. Each check valve shall be provided with an NEMA 4X limit switch mounted on the horizontal centerline of the body seat.
 - 6. Provide a manually operated backflow device which shall positively lock open flapper during full backflow.
 - 7. The FLEX portion of the disc shall have a 20-year warranty.
 - 8. Valves shall be manufactured by Apco Valve and Primer Corp., Series 100, Val-Matic Valve and Manufacturing Corp., Swing Flex, or equal.
- C. Swing Check Valves
 - 1. Swing check valves shall conform to AWWA C508.
 - 2. The valve body shall be 2-piece cast iron conforming to ASTM A126 with flanged ends conforming to ANSI B16.1. The area throughout the valve body shall be equal to the full pipe area.
 - 3. The valve disc shall be ductile iron with bronze or resilient seating face. The disc shall be partially balanced with a short travel to resist slamming.
 - 4. The seat ring and disc ring shall be ASTM B763 Alloy 84400 bronze, with beveled edges, firmly clamped or screwed into the valve body. Seat rings and disc rings shall be field replaceable.
 - 5. The hinge pin shall be of stainless steel with bronze bushings, allow free movement of the disc without binding, and shall be guaranteed not to stick in the closed position.
 - 6. The valve shall be designed for a minimum working pressure of 150-psi.
 - 7. Valves shall be supplied with an outside lever and adjustable weight.

8. Valves 4-inches and larger shall be 8-mil epoxy lined.

D. Cushioned Swing Check Valves (Potable Water and High Pressure Effluent Application greater than 50-psi).

1. All materials shall be as follows:

Table 15105-1
Materials of Construction

PART	MATERIAL	ASTM or SAE
Body, Cover, Disc	Cast Iron	A 126 GR.B
Disc Arm	Ductile Iron	A 536
Seat	Aluminum bronze or Stainless Steel	B 148 A 276
Seat Ring	Buna-N rubber or Metal	
Hinge Shaft	Stainless Steel	Type 303

2. Valve body shall have integral flanges.
3. The seat shall be centrifugally cast bronze with an o-ring seal and be locked in place with stainless steel lock screws and be field replaceable without the use of special tools.
4. The shaft shall be single and continuous stainless steel, extending both sides of the body with a lever and weight, using a side-mounted air cushion cylinder.
5. The air cushion cylinder shall be constructed of corrosion resistant material and the piston shall be totally enclosed. The cylinder assembly shall be externally mounted to the valve body and will permit adjustability to cushion the closure of the check valve.
6. The valve shall prevent backflow of water on normal pump shut-off or power failure and shall be watertight.
7. A valve position indicator and micro switch shall be provided to remotely indicate open/close position of check valve.
8. Valve body area shall equal or exceed the full pipe area.
9. Valve shall be Series 6,000 air cushioned swing check valve as manufactured by APCO or acceptable equal.

PART 3 - EXECUTION

3.01 INSTALLATION

- A. Install valves and accessories in strict accordance with manufacturer's instructions and recommendations, as shown on the Drawings and/or as directed by the Owner.
- B. Carefully erect all valves and support them in their respective positions free from distortion and strain.

- C. Bolt holes of flanged valves shall straddle the horizontal and vertical centerlines of the pipe run to which the valves are attached. Clean flanges by wire brushing before installing flanged valves. Clean flange bolts and nuts by wire brushing, lubricate threads with oil and graphite, and tighten nuts uniformly and progressively. Clean threaded joints by wire brushing or swabbing. Apply Teflon joint compound or Teflon tape to pipe threads before installing threaded valves. Joints shall be watertight.
- D. Support all valves connected to pumps and equipment, and in piping systems that cannot support valves.
- E. Repair any scratches, marks and other types of surface damages, etc., with original prime coating as supplied by the factory.
- F. Apply finish coating in accordance with Division 9.

3.02 DEMONSTRATION AND TESTING

- A. Demonstration, start-up (adjustment) and testing shall demonstrate that all valves have been properly installed and that check valves operate properly.

END OF SECTION

THIS PAGE LEFT BLANK INTENTIONALLY

SECTION 15110
PLUG VALVES

PART 1 - GENERAL

1.01 DESCRIPTION

Wastewater force mains shall have plug valves installed as shown on the Drawings. This Section specifies plug valves, manual actuators and associated valve boxes.

1.02 QUALITY ASSURANCE

A. References

Reference	Title
ANSI B16.1	Cast Iron Pipe Flanges and Flanged Fittings Class 25, 125, 250, and 800
ASTM A126	Gray Iron Castings for Valves, Flanges, and Pipe Fittings
ASTM A276	Stainless and Heat-Resisting Steel Bars and Shapes
ASTM A436	Austenitic Gray Iron Castings
ASTM A536	Ductile Iron Castings
AWWA C504	Rubber Seated Butterfly Valves

B. Proof-of-Design Tests

The Contractor shall furnish the County three (3) certified copies of a report from an independent testing laboratory certifying successful completion of proof-of-design testing conducted in accordance with AWWA C504, Section 5.2, except that where the word "disc" appears in the standard, it is understood to mean "plug." In lieu of testing the valves at an independent testing laboratory, proof-of-design testing may be performed at the valve manufacturer's laboratory, but must be witnessed by a representative of a qualified independent testing laboratory, and all test reports must be certified by the laboratory representative. Proof-of-design testing shall have been performed on at least 3 (three) 6-inch diameter valves, with all 3 (three) test units demonstrating full compliance with the test standards. Failure to satisfactorily complete the test shall be deemed sufficient evidence to reject all valves of the proposed make or manufacturer's model number.

1.03 SHOP DRAWINGS AND SUBMITTALS

A. Submittals shall be submitted to the County/Professional for review and acceptance prior to construction in accordance with the General Conditions and specifications Section 01300 "Submittals."

- B. **PRODUCT DATA:** The following information shall be provided in accordance with 1.03 of Section 01300 "Submittals."
1. Manufacturer's product data
 2. Proof-of-design test reports specified in paragraph 1.02 B

PART 2 - PRODUCTS

2.01 GENERAL

- A. All material supplied shall be one of the products specified in Appendix D "List of Approved Products" appended to these technical specifications.

2.02 MANUFACTURERS

Plug valves meeting the requirements of this Section shall be supplied from the approved manufacturers as listed in Appendix D "List of Approved Products."

2.03 MATERIALS

Materials of construction shall be as follows:

Component	Material
Body	Cast iron, ASTM A126, Class B
Plug	Cast iron, ASTM A126, Class B, or cast iron ASTM A436 (Ni-resist), or ductile iron, ASTM A536
Plug facing	Neoprene
Body seats	
3-inches and larger	Nickel
Packing	Buna V-flex or TFE

2.04 MANUFACTURE

- A. **Plug Valves:** Valves shall be straight-flow non-lubricated resilient plug type suitable for drip tight, bi-directional shutoff at the specified valve design pressure.
1. Plug valves shall be eccentric, ball centric or full port. All valves shall open counter-clockwise.
 2. All buried valves shall be fitted with valve boxes as specified in Paragraph 2.03.B of this Section. One 2-inch square tee-handled valve wrench, made by the valve manufacturer, of suitable length to operate all valves within valve boxes shall be furnished for every 5 valves installed.
 3. Plug valves shall be installed complete with extension stems, buried gear actuators, and 2-inch operating nuts (buried) or operating hand wheels (exposed), as required for normal operation. All valve nuts shall be brought up to 1-foot below the proposed finish grade.

4. Valves shall have the name of the manufacturer and the size of the valve cast or molded onto the valve body. A permanent plate shall be attached to the valve or operator indicating serial number, order number, accessories, operator model and manufacturer.
5. Ball centric/eccentric plug valves shall be of the non-lubricated type. The port area for valves 4-inches to 20-inches shall have a minimum 80% nominal pipe diameter and valves 24-inches and larger shall have a minimum port area of 70% of nominal pipe diameter unless noted on the Drawings as "full port". Plug valves denoted as full port shall have a port area equal to the full area of the nominal pipe diameter.
6. Minimum pressure rating of valves 4-inches to 12-inches shall be 175-psi; valves 14-inches to 72-inches shall be 150-psi. Valve bodies shall be cast iron ASTM A126, Class B and fusion-bonded epoxy coated.
7. Valve ends shall be mechanical joint (buried) or flanged (exposed) as indicated on the Drawings. Valve flange drilling for valves 3-inches and larger shall be per ANSI B16.1, Class 125. Plugs shall be cast iron or ductile iron with neoprene facing and shall be of the single piece design. The plug shall be of the same configuration for all valves and shall require no stiffening member opposite the plug for balance or support. Valve body seats shall have a welded-in overlay of not less than 90% nickel. Packing shall be adjustable and safely replaceable without disassembling the valve. Bushing shall be 316 stainless steel in both upper and lower journals and shall be protected from foreign matter with the use of a grit seal or similar. The valve should be capable of drip tight shut off with flow in either direction at the full pressure of the valve. All exposed nuts, bolts, springs and washers on buried service valves shall be 304 stainless steel. All above-grade valves shall have 316 stainless steel hardware.
8. Actuators: Manual valves shall have lever or gear actuators and tee wrenches, extension stems, and floor stands as indicated on the Drawings. Valves 6-inch and larger shall be equipped with buried service rated gear actuators. Buried valves shall have a 2-inch square operating nut. All gearing shall be enclosed in a steel housing and be suitable for running in a lubricant with seals provided on all shafts to prevent entry of dirt and water into the actuator. Actuator shafts shall be supported on permanently lubricated bronze bearings. Actuators shall clearly indicate valve position and an adjustable stop shall be provided to set closing torque. Exposed nuts, bolts and washers shall be 316 stainless steel. Valve packing adjustment shall be accessible without disassembly of the actuator.
9. Valve Testing: Plug valves shall be tested in accordance with AWWA C504. Each valve shall meet the performance, leakage, and hydrostatic tests described in AWWA C504. The leakage test shall be applied to the face of the plug tending to unseat the valve. The manufacturer shall furnish certified copies of reports covering proof-of-design testing as described in AWWA C504.

B. Valve Boxes

1. All valves installed underground shall have cast iron 2-piece valve boxes. Valve boxes shall be provided with suitable heavy bonnets and shall extend to such elevation at or slightly above the finished grade surface as directed by the County. The barrel shall be screw type only, with a 5-1/4-inch shaft. The upper section shall have a flange at the bottom having sufficient bearing area to prevent settling and shall be complete with locking cast iron covers. Covers shall have "SEWER" cast into the top for all wastewater mains which shall be so constructed as to prevent tipping or rattling.

2. A valve box with an operating nut extension is required for any size main that is 6-feet or greater below finished grade. The extension shall be high strength, corrosion resistant steel construction and permanently attached to the operating nut. The operating nut extension insert shall be one complete assembled unit with a self-adjusting extension stem system that fits inside a standard valve box. All moving parts of the extension stem shall be enclosed in a housing to prevent contact with the soil. A valve box-centering device designed to eliminate the shifting of the valve box against the operating nut of the valve shall be used. The valve box assembly shall be adjustable to accommodate variable trench depths 6-foot and greater as shown in the Drawings.
3. The stem assembly shall be of a telescoping design that allows for variable adjustment length. The material shall be galvanized square steel tubing. The stem assembly shall have a built-in device that prevents the stem assembly from disengaging at its fully extended length. The extension stem must be capable of surviving a torque test to 1,000 foot-pounds without failure.
4. The valve boxes shall have locking lids.
5. Extension sections shall be cast or ductile iron only.
6. Valve boxes in non-paved areas shall be installed with a valve collar as shown in the Drawings. The protective concrete collar with a bronze identification disc shall be constructed of Class B concrete as shown on the Drawings.

PART 3 - EXECUTION

3.01 INSTALLING VALVES AND BOXES

- A. Valves: Valves shall be carefully inspected, opened wide and then tightly closed and the various nuts and bolts shall be tested for tightness. Plug valves shall have the plug shaft installed horizontally with the plug rotating upward to the top of the valve. Any valve that does not operate correctly shall be removed and replaced. Seats shall face in the direction as recommended by the manufacturer.
- B. Valve Boxes: Valve boxes and risers shall be carefully centered over the operating nuts of the valves so as to permit a valve key to be fitted easily to the operating nut. In unpaved areas, valve boxes shall be set to conform to the level of the finished surface and held in position by a concrete collar placed under the support flange as shown on the Drawings. The valve box shall not transmit surface loads to the pipe or valve. Extensions or risers for valve boxes shall be an integral part of the box. No cut sections of ductile iron or PVC pipe shall be used in extending the box to its proper height. Care shall be taken to prevent earth and other material from entering the valve box. Any valve box which is out of alignment or whose top does not conform to the finished ground surface shall be dug out and reset. Before final acceptance of the Work all valve boxes shall be adjusted to finish grade.

END OF SECTION

SECTION 16010
ELECTRICAL GENERAL PROVISIONS

PART 1 - GENERAL

1.01 WORK INCLUDED

A. The Work covered under this Division of the Specifications is intended to include the furnishing of all materials, equipment and labor necessary for or reasonably incidental to, the installation of a complete and fully operative electrical system as indicated on the Drawings and specified in this Section.

1. The Work shall consist generally of, but is not limited to, the following major items:
 - a. Circuit Protective Devices
 - b. Conduit and Wiring
 - c. Equipment Connections
 - d. Temporary power

B. Work Not Included: The following work is not included in this Section:

1. Furnishing of pump control panels.

C. Fees and Permits

1. Obtain all permits required for the Work and include the cost of same in bid.
2. The Contractor shall also include in the bid, the cost for the power company service.

D. Certificate of Inspection

The Contractor shall pay for a final inspection made of the complete electrical installation and shall deliver a certificate of approval of the complete Work to the County before receiving final payment.

E. Service

Voltage and Phase as indicated on the Drawings. Secondary metered electrical power underground or overhead as indicated on the Drawings. Serving electrical utility company is as noted on the Drawings.

1.02 SHOP DRAWINGS AND SUBMITTALS

A. Submittals shall be submitted to the County for review and acceptance prior to construction in accordance with the General Conditions and specifications Section 01300 "Submittals."

B. Submit to the County as provided in the General Conditions, Shop Drawings, manufacturer's literature and technical data on the proposed electrical systems before commencing work.

C. Shop Drawings

1. Submit copies of manufacturer's drawing of surge protection devices, circuit protective devices, panel boards, conduit, wire, wiring devices, and any other special electrical equipment to be installed, and shall receive the County's acceptance before ordering the same for installation.
2. All Shop Drawings shall be submitted in a 3-ring binder with each specification section indicated with tabs.
3. If Shop Drawings are submitted intermittently and not in 3-ring binders, they will not be reviewed and they will be returned to the Contractor for proper submittal.
4. Acceptable Equivalent
 - a. Any manufacturer and/or catalog number listed on the Drawings or in the Project Manual shall be construed to mean "or acceptable equivalent" as listed in Appendix D "List of Approved Products."
 - b. Any substitutions to be considered as "Acceptable Equivalent" shall be submitted with both the cut of the proposed substitution and a cut of the specified equipment to the County in writing, and returned to the Contractor at least 10-days prior to bid opening.
 - c. No substitutions shall be submitted or will be allowed after the contract has been awarded.

1.03 QUALITY ASSURANCE

A. Qualifications of manufacturers, materials and equipment

1. Material and equipment, except as herein otherwise noted, shall be new and conform to standards specified herein defined to include conduits, cable, wiring materials and devices and panel boards.
2. Materials and equipment shall be of an approved design.
 - a. Similar materials shall be of one manufacturer wherever possible.
3. Equipment offered under these Specifications shall be limited to products regularly produced and recommended for service ratings in accordance with manufacturer's catalogs, engineering data, or other comprehensive literature made available to the public and in effect at the time of opening of bids.
4. Install equipment in strict accordance with manufacturer's instruction for type, capacity and suitability of each piece of equipment used.
 - a. Obtain these instructions, which shall be considered a part of these Specifications.

B. Qualifications of supervisor, workmanship and installers

1. The Contractor shall have a Master Electrician constantly supervising the Work covered by these Specifications, and so far as possible shall keep the same foreman on the job from start to finish.
 - a. The workmanship of the entire job shall be excellent and only experienced and competent workers shall be employed for the Work.

1.04 CODES AND REGULATIONS

- A. Work shall be installed in accordance with the regulations and requirements of the National Electrical Code NFPA No. 70; Life Safety Code NFPA No. 101, Standard Building Code as well as all rules, state and local codes, regulations and requirements of the telephone and power companies.
- B. Where conduits and/or cables penetrate wetwell walls, the penetrations shall be sealed in accordance with NFPA 70, Article 500.
 - 1. The above shall be ascertained and fully coordinated before the installation of any material, equipment, and the like, and any discrepancy shall be immediately brought to the attention of the County in writing, and the Contractor shall receive a disposition of same before proceeding with the Work.
 - 2. Furnish, without additional charge, any additional materials and labor that may be required for compliance with these codes, law, rules, regulations or requirements even though the work is not mentioned in these Specifications or shown on the Drawings.
- C. Material and equipment shall bear the label of approval of the National Board of Fire Underwriters Laboratory.

1.05 INSPECTIONS

- A. All work and materials covered by these Specifications and shown on the Drawings shall be subject to inspection at any and all times by the County.
- B. If the County finds that any material does not conform with these Specifications, the Contractor shall within 3-days after being notified by the County; remove the material from the premises, and if said material has been installed, the entire expense of removing and replacing same, including any cutting and patching that may be necessary, shall be borne by the Contractor.
- C. Tests

The County reserves the right to inspect and test any portion of the equipment during the progress of this Work.

- 1. The Contractor shall test the entire system in the presence of the County when the Work is completed to insure that all portions are free from short circuits and grounds.
- 2. All equipment, material and labor necessary to conduct the above tests shall be furnished at the Electrical Contractor's expense.

1.06 PRODUCT HANDLING

- A. Protection of Equipment, Material and Work: The Contractor shall effectively protect and pay for protection of the work, materials or equipment, as is liable to injury during the construction period.
 - 1. Openings into any part of the conduit system as well as associated fixtures, equipment, and the like, both before and after being set in place, shall be securely covered or otherwise protected to prevent obstruction of the conduit, or injury due to carelessness or maliciously dropped tools or materials, grit, dirt, or any foreign matter.
 - a. The Contractor will be held responsible for all damage done until the Work is fully and finally accepted.
 - 2. Cover conduit ends with capped bushings.
- B. Repair of damage: In the event of damage, repair shall be made immediately, to the County's satisfaction and at no additional cost to the County.
- C. Special Handling: Special care, storage and handling of new and existing lighting fixtures shall be taken to minimize breakage of lenses and lamps shipped with fixtures.
 - 1. Immediately replace any breakage with the exact lens or lamp.

1.07 JOB CONDITIONS

- A. Accuracy of Data: The data given herein and on the Drawings are as exact as could be secured.
 - 1. The Specifications and Drawings are for the assistance and guidance of the Contractor.
 - 2. Exact locations, distances, levels, and the like, will be governed by the building field conditions and the Contractor shall use the data contained herein with this understanding.
- B. Drawings
 - 1. The electrical drawings are diagrammatic, but shall be followed as closely as actual construction and work of other Contractors will permit.
 - 2. Deviations from diagrammatic electrical drawings required by either building construction or the work of other Contractors shall be made by the Contractor at his/her expense.
 - 3. It is not the intention of the Drawings or specifications to indicate each piece of conduit and fittings required for the satisfactory operation of the installation and whereby one is indicated, but not specified, or specified but not indicated on the Drawings, it shall be considered to be both specified and indicated.
- C. Measurements
 - 1. Review the Contract Drawings and Specifications and visit the job site to ascertain all conditions, including conduit runs, interfacing, interferences, conflicts, discrepancies, etc., and shall report the same to the County for clarification 10-days prior to submittal of the bid.

2. Failure to comply with this condition shall constitute an acceptance of the conditions and any necessary changes will be at Contractor's expense.
3. The Contractor shall make all measurements necessary for his/her work and shall assume responsibility for their accuracy.
4. Install necessary pull boxes, manholes and junction boxes as may be required to accomplish the distribution system indicated on the riser diagram.

D. Structural difficulties: Should any structural difficulties prevent the setting of cabinets, running conductors, and the like, at points indicated on the Drawings, the necessary deviation will be as determined by the County shall be made without additional cost.

E. Cooperation with Other Contractors

1. The Contractor shall arrange all parts of his/her work in proper relation to the work of other Contractors.
2. Where interferences occur, the Contractor shall, before installing the work involved, consult with the County as to exact location and level of his/her work.
3. The County's decision will be final.
4. The Contractor shall be responsible for arrangement of his/her work and equipment and maintenance of proper headroom under this Work.
5. Should work installed under this Section require any modifications to avoid interference with the other work, such changes shall be made without additional cost.
6. The County's decision as to determination or allocation or responsibility where conditions require changing of work, shall be final.
7. If any work of the Contractor is dependent for its proper execution on contiguous work, examine such work and report in writing any defect thereon or conditions rendering it unsuitable.
8. The beginning of work, without making such report, shall constitute an acceptance of such work, and any defects in his/her own work consequently shall be his/her responsibility.

1.08 TEMPORARY SERVICE

- A. Temporary power: Provide, maintain and remove after construction is completed, a temporary, receptacle and power system in accordance with the progress schedule.
 1. Receptacles: Ground fault interrupter type.
 2. Three Phase Power for Testing Motors: Provided at all necessary points.
- B. Temporary telephone service: Each respective trade shall be responsible for providing and maintaining their telephone services.

1.09 CLEANING

- A. Keep the premises free of debris and unusable materials resulting from the Work, and immediately upon completion of the Work remove such debris and material from the site and leave floors broom clean in areas affected by the Work.

1.10 GUARANTEE

- A. Leave the electrical installation in proper working order and without charge, replace any work or materials which develop defects within 1-year from date of final inspection and acceptance by the County.

1.11 DEFINITIONS

- A. In this Division "provide" is used as a term contraction meaning "to furnish, install and connect up completely in the specified or in an approved manner for the item and/or material described."

PART 2 - PRODUCTS (NOT USED)

PART 3 - EXECUTION (NOT USED)

END OF SECTION

SECTION 16110

RACEWAYS

PART 1 - GENERAL

1.01 RELATED DOCUMENTS

- A. Drawings and general provisions of Contract, including General and Supplementary Conditions and Division 1 Specification sections, apply to work of this Section.

1.02 DESCRIPTION OF WORK

- A. Extent of raceway work is indicated by drawings and schedules.
- B. Types of raceway specified in this Section include the following:
 - 1. Liquid tight flexible metal conduit
 - 2. Rigid non-metallic conduit (PVC)
 - 3. Rigid aluminum conduit
- C. Electrical non-metallic tubing (ENT) is not acceptable.

1.03 QUALITY ASSURANCE

- A. Manufacturers: Firms shall have sufficient experience that will allow for quality and successful manufacture of raceway systems of types and sizes required for this Project.
- B. Installer's Qualifications: Firms shall have sufficient experience to allow for quality and successful installation of electrical raceway work required for this Project.

1.04 CODES AND STANDARDS

- A. NEMA Compliance: Comply with applicable requirements of NEMA Standards Publications pertaining to raceways.
- B. UL Compliance and Labeling: Comply with applicable requirements of UL safety standards pertaining to electrical raceway systems. Provide raceway products and components which have been UL listed and labeled.
- C. NEC Compliance: Comply with applicable requirements of NFPA-70 pertaining to construction and installation of raceway systems.
- D. Comply with NECA "Standard of Installation."
- E. Coordinate layout and installation of raceway and boxes with other construction elements to ensure adequate headroom, working clearance, and access.

1.05 SHOP DRAWINGS AND SUBMITTALS

- A. Submittals shall be submitted to the County for review and acceptance prior to construction in accordance with the General Conditions and specifications Section 01300 "Submittals."
- B. Product Data: Submit manufacturer's technical product data, including specifications and installation instructions for each type of raceway system required. Include data substantiating that materials comply with requirements.
- C. A copy of this specification section, with addendum updates included, and all referenced and applicable sections, with addendum updates included, with each paragraph check-marked to indicate specification compliance or marked to indicate requested deviations from specification requirements. Check marks shall denote full compliance with a paragraph as a whole.
- D. If deviations from the specifications are indicated, and therefore requested by the Contractor, each deviation shall be underlined and denoted by a number in the margin to the right of the identified paragraph, referenced to a detailed written explanation of the reasons for requesting the deviation.
- E. The County shall be the final authority for determining acceptability of requested deviations. The remaining portions of the paragraph not underlined will signify compliance on the part of the Contractor with the specifications.
- F. Failure to include a copy of the marked-up specification sections, along with justification(s) for any requested deviations to the specification requirements, with the submittal shall be sufficient cause for rejection of the entire submittal with no further consideration.

PART 2 - PRODUCTS

2.01 GENERAL

- A. All material supplied shall be one of the products specified in Appendix D "List of Approved Products" appended to these technical specifications.

2.02 NON-METALLIC CONDUIT

- A. General: Provide non-metallic conduit and fittings of types, sizes, and weights for each service indicated. Where types and grades are not indicated, provide proper selection determined by Installer to fulfill wiring requirements, which comply with provisions of NFPA-70 for raceway.

B. Electrical Plastic Conduit

1. Extra Heavy Wall Conduit: Schedule 80, UL rated, construct of polyvinyl chloride compound C 200 PVC, and UL listed in accordance with NFPA-70 Article 347 for direct burial, or above ground use. Conduits shall be UL listed and marked for use with conductors having 90°C insulation. Use conduits, couplings, bushings, elbows, nipples, and other fittings meeting the requirements of NEMA TC 2 and TC 3, Federal Specification W C 1094, UL, NEC, and ASTM specified tests for the intended use. Use only conduit with a factory formed bell on 1 end. Conduit that requires the use of couplings for straight runs will not be acceptable. Minimum size 3/4-inch exposed, 1-inch embedded or buried.

- C. Conduit and Tubing Accessories: Provide conduit and accessories of types, sizes, and materials, complying with manufacturers published product information, which mate and match conduit.

- D. Conduit Bodies: Provide extra heavy PVC conduit bodies of types, shapes and sizes as required to fulfill job requirements and NFPA-70 requirements. Construct conduit bodies with threaded conduit entrance ends, removable covers, either cast or of galvanized steel and corrosion resistant screws.

- E. Available Manufacturers: Subject to compliance with requirements, manufacturers offering conduit bodies which may be incorporated in the Work include, but are not limited to the following:

1. Appleton Electric; Div. of Emerson Electric Co.
2. Arrow Hart Div.; Crouse Hinds Co.
3. Bell Electric Div.; Square D Co.
4. Killark Electric Mfg. Co.
5. O Z/Gedney Div.; General Signal Co.
6. Spring City Electrical Mfg. Co.

2.03 RIGID ALUMINUM CONDUIT

- A. Meet requirements of ANSI C80.1 and UL6.

- B. Material: Type 6063, copper free aluminum alloy.

- C. Available Manufacturers

1. Appleton Electric, Div. Of Emerson Electric Co.
2. Arrow Hart Div; Crouse Hinds Co.
3. Bell Electric Div.; Square D Co.
4. O-Z/Gedney Div.; General Signal Co.

- D. Minimum size shall be 3/4-inch unless noted otherwise or permitted by the following: 1/2-inch may be used for connections to individual instruments, outlets, wiring devices and indoor lighting fixtures.

2.04 LIQUIDTIGHT FLEXIBLE METAL CONDUIT AND FITTINGS

- A. Liquid-tight Flexible Steel Conduit (LFS): UL listed liquid tight consisting of an extruded thermoplastic cover over a galvanized steel core. Minimum size 3/4-inch unless for equipment with 1/2-inch knockout.
- B. Fittings and Conduit Bodies: NEMA FB-1; galvanized steel compression type with O-ring.

PART 3 - EXECUTION

3.01 INSTALLATION

- A. General: Install raceways as indicated; in accordance with manufacturer's written installation instructions, and in compliance with NFPA-70, and NECA's "Standards of Installation."
- B. Coordinate with other work including wires/cables, boxes and panel work, as necessary to interface installation of electrical raceways and components with other work.
- C. Install conduits concealed below grade or in slabs. Where conduits turn up and/or cannot be concealed, route conduits exposed.
- D. Mechanically fasten together conduits, enclosures and raceways for conductors to form continuous system. Connect to electrical boxes, fittings and cabinets to provide firm mechanical assembly.
- E. Avoid use of dissimilar metals throughout system to eliminate possibility of electrolysis. Where dissimilar metals are in contact, coat surfaces with corrosion inhibiting compound before assembling.
- F. Cap conduits or plug flush conduits during construction to prevent entrance of dirt, trash, and water. Cap or plug empty conduits designated as "future", "spare", or "empty" and include a pulling line accessible at both ends. Use anti-seize compound on cap and plug threads prior to installation.
- G. Protect stub-ups from damage where conduits rise through floor slabs. Arrange so curved portion of bends is not visible above the finished slab.
- H. Make bends and offsets so the inside diameter is not reduced. Unless otherwise indicated, keep the legs of a bend in the same plane and the straight legs of offset parallel.
- I. Use raceway fittings compatible with raceway and suitable for use and location. Fitting sizes shall be such that the enclosed conductors do not exceed the permissible percentage of fitting area/volume.

- J. Install miscellaneous fittings such as reducers, chase nipples, 3-piece unions, split couplings, and plugs that have been specifically designed and manufactured for their particular application. Install expansion fittings in raceways every 200-foot linear run or wherever structural expansion joints are crossed.
- K. Use roughing in dimensions of electrically operated unit furnished by supplier. Set conduit and boxes for connection to units only after receiving review of dimensions and after checking location with other trades.
- L. Provide nylon pull cord in all empty conduits. Test conduits required to be installed, but left empty; test with ball mandrel. Clear any conduit, which rejects ball mandrel. Pay costs involved for restoration of conduit and surrounding surfaces to original condition.

3.02 CONDUIT INSTALLATION

- A. Use Schedule 80 PVC throughout above grade and for turn ups including elbows and bends and where required.
- B. Use rigid aluminum above grade between control panel and conduit seals.
- C. Cut conduits straight and properly ream.
- D. Field bend conduit with benders designed for purpose so as not to distort nor vary internal diameter.
 - 1. Size conduits to meet NFPA-70, except no conduit smaller than 3/4-inches shall be embedded in concrete or installed below grade.
 - 2. Fasten conduit terminations in sheet metal enclosures by threaded hubs, and terminate with insulating bushings.
 - 3. Complete installation of electrical raceways before starting installation of cables/wires within raceway.

3.03 CONCEALED CONDUITS

- A. Install coupling full depth to ensure watertight integrity.
- B. Install underground conduits minimum of 24-inches below finished grade.

3.04 CONDUITS IN CONCRETE SLAB

- A. Place conduits between bottom reinforcing steel and top reinforcing steel.
- B. Place conduits either parallel, or at 90° (degrees) to main reinforcing steel.
- C. Separate conduits by not less than diameter of largest conduit to ensure proper concrete bond.
- D. Conduits crossing in slab must be reviewed for proper cover by the County.

E. Embedded conduit diameter is not to exceed 1/3 (one-third) of slab thickness.

F. Install conduits as not to damage or run through structural members.

3.05 NON METALLIC CONDUITS

A. Make solvent cemented joints in accordance with recommendations of manufacturer.

B. Install PVC conduits in accordance with NFPA-70 and in compliance with local practices.

3.06 CONDUIT FITTINGS

A. Construct locknuts for securing conduit to metal enclosure with sharp edge for digging into metal, and ridged outside circumference for proper fastening.

B. Install insulated type bushings for terminating conduits. Bushings shall have cast flared bottom and ribbed sides. Upper edge to have phenolic insulating ring molded into bushing. Bushings shall be "O.Z" type or "B" or equal.

C. Bushings shall have screw type grounding terminal.

D. Miscellaneous fittings such as reducers, chase nipples, 3-piece unions, and plugs to be specifically designed for their particular application.

END OF SECTION

SECTION 16120
WIRES AND CABLES

PART 1 - GENERAL

1.01 RELATED DOCUMENTS

- A. Drawings and general provisions of Contract, including General and Supplementary Conditions and Division 1 Specifications sections, apply to work of this Section.
- B. Work described in this Section includes furnishing all labor, materials, equipment, tools and incidentals required for a complete and operable installation of all electrical conductors, wire and cables and associated splices, connectors, and termination for wiring systems rated 600 volts or less. All electrical conductors shall be installed, adjusted, tested and placed in operation in accordance with these Specifications, the manufacturer's recommendations and as shown on the Drawings.

1.02 DESCRIPTION OF WORK

- A. Extent of electrical wires and cable work is indicated by drawings and schedules.
- B. Types of electrical wire, cable, and connectors specified in this Section include the following:
 - 1. Copper conductors
 - 2. 2 and/or 4 bolt connectors
 - 3. Wire nut connectors
- C. Applications of electrical wire, cable, and connectors required for project are as follows:
 - 1. For power distribution circuits
 - 2. For control and equipment circuits
 - 3. For motor branch circuits

1.03 QUALITY ASSURANCE

- A. Manufacturers: Firms shall have sufficient experience that will allow for quality and successful manufacture of electrical wire and cable products of types, sizes and ratings required for items required for this Project.
- B. Installer's Qualifications: In addition to the requirements specified in Division 16 an independent testing firm shall meet OSHA criteria for accreditation of testing laboratories, Title 29, Part 1907 quality and successful installation of wire and cable products for this Project.
- C. NFPA-70 Compliance: Comply with NFPA-70 requirements as applicable to construction, installation and color-coding of electrical wires and cables.

- D. UL Compliance: Comply with applicable requirements of UL Std. 83, "Thermoplastic Insulated Wires and Cables" and Std. 486A, "Wire Connectors and Soldering for Use With Copper Conductors".
- E. UL Compliance: Provide wiring/cabling and connector products, which are UL, listed and labeled.
- F. NEMA/ICEA Compliance: Comply with NEMA/ICEA Std. Pub/No's WC5, Thermoplastic Insulated Wires and Cable for the "Transmission and Distribution of Electrical Energy", and WC30, "Color Coding of Wires and Cables", pertaining to electrical power type wires and cables.
- G. IEEE Compliance: Comply with applicable requirements of IEEE Standards 82, "Test Procedures for Impulse Voltage Tests on Insulated Conductors", and Standard. 241, "IEEE Recommended Practice for Electric Power Systems in Commercial Buildings" pertaining to wiring.
- H. ASTM Compliance: Comply with applicable requirements of ASTM B1, 2, 3, 8, and D-573. Provide copper conductors with conductivity of not less than 98% at 20°C (68°F.)
- I. FOIST Compliance: Comply with Federal Specifications J C 30, "Electrical Cable and Wire (Power, Fixed, Installation)", and W-S-610, "Splice Conductor."
- J. Listing and Labeling: Provide products specified in this Section that are listed and labeled.
 - 1. The Terms "Listed" and "Labeled": As defined in the "National Electrical Code", Article 100.
 - 2. Listing and Labeling Agency Qualifications: A "Nationally Recognized Testing Laboratory" (NTRL) as defined in OSHA Regulation 1910.7.

1.04 SHOP DRAWINGS AND SUBMITTALS

- A. Submittals shall be submitted to the County/Professional for review and acceptance prior to construction in accordance with the General Conditions and specifications Section 01300 "Submittals."
- B. Product Data: Submit manufacturer's data on electrical wires, cables, and conductors.
- C. A copy of this specification section, with addendum updates included, and all referenced and applicable sections, with addendum updates included, with each paragraph check-marked to indicate specification compliance or marked to indicate requested deviations from specification requirements. Check marks shall denote full compliance with a paragraph as a whole.
- D. If deviations from the specifications are indicated, and therefore requested by the Contractor, each deviation shall be underlined and denoted by a number in the margin to the right of the identified paragraph, referenced to a detailed written explanation of the reasons for requesting the deviation.

- E. The County shall be the final authority for determining acceptability of requested deviations. The remaining portions of the paragraph not underlined will signify compliance on the part of the Contractor with the specifications.
- F. Failure to include a copy of the marked-up specification sections, along with justification(s) for any requested deviations to the specification requirements, with the submittal shall be sufficient cause for rejection of the entire submittal with no further consideration.

1.05 DELIVERY, STORAGE, AND HANDLING

- A. Deliver wire and cable properly packaged in factory-fabricated type containers, or wound on NEMA specified type wire and cable reels.
- B. Store wire and cable in clean dry space in original containers. Protect products from weather, damaging fumes, construction debris and traffic.
- C. Handle wire and cable carefully to avoid abrasing, puncturing, and tearing wire and cable insulation and sheathing. Ensure that dielectric resistance integrity of wires/cables is maintained.

PART 2 - PRODUCTS

2.01 GENERAL

- A. All material supplied shall be one of the products specified in Appendix D "List of Approved Products" appended to these technical specifications.

2.02 ACCEPTABLE MANUFACTURERS

- A. Available Manufacturers: Subject to compliance with requirements, manufacturers offering products which may be incorporated in the Work include, but are not limited to the following:
 - 1. Wire and Cable
 - a. Alpha Wire Corporation
 - b. Apex Wire and Cable Corp.
 - c. American Insulated Wire Corp.
 - d. American Wire and Cable Co.
 - e. Anaconda-Ericson Inc., Wire and Cable Div.
 - f. Beldon Div.; Cooper Industries
 - g. Brand-Rex Div.; Pyle National Co.
 - h. Cablec
 - i. Cerro Wire and Cable Corp.
 - j. Cleveland Insulated Wire Co.
 - k. Dekoron
 - l. Konite
 - m. Penn

- n. Pirelli
 - o. Phelps Dodge Cable and Wire Co.
 - p. Rome Cable Corp.
 - q. Southwire Corp.
 - r. Triangle PWC, Inc.
2. Connectors
- a. AMP, Inc.
 - b. Anderson
 - c. Appleton Electric Co.; Emerson Electric Co.
 - d. Burndy Corporation
 - e. Brand-Rex Div.; Pyle National Co.
 - f. Electrical Products Div.; Midland Ross Corp.
 - g. General Electric Co.
 - h. Ideal Industries, Inc.
 - i. 3M Company
 - j. Monograms Co.
 - k. O-Z/Gedney Co.
 - l. Pyrotenax
 - m. Southport Industries Inc.
 - n. Square D Company
 - o. Thomas and Betts Corp.

2.03 WIRES, CABLES, AND CONNECTORS

- A. General: Provide electrical wires, cables, and connectors of manufacturer's standard materials, as indicated by published product information; designed and constructed as recommended by manufacturer, for a complete installation, and for application indicated. Except as otherwise indicated, provide copper conductors with conductivity of not less than 98% at 20°C (68°F.)
- B. Building Materials: Provide factory-fabricated wires of sizes, ampacity ratings, and materials for applications and services indicated. Where not indicated, provide proper wire selection as determined by installer to comply with project's installation requirements, NFPA-70 and NEMA standards. Select from the following UL types, those wires with construction features, which fulfill project requirements.
1. Type THW/THHN/ THWN, dual rated: For dry or wet locations; maximum operating temperature 75°C (167°F.) Insulation, flame retardant, moisture and heat resistant, thermoplastic; outer covering, nylon jacket; conductor, annealed copper. NEMA WC-5 thermoplastic insulated building wire. 98% conductivity copper, 600V PVC insulated with nylon jacket, 75/90 wiring type. Minimum size #12 AWG. For control circuits minimum size #14 AWG.
 2. Type XHHW: For dry and wet locations; maximum operating temperature 90°C (194°F.) Insulation, flame retardant, cross-linked synthetic polymer; conductor, annealed copper.

3. Type 1 (600 Volt Multi-Conductor Control Conductor Cable, Type TC)
 - a. General: Multi conductor control circuit interconnection cable with ground. Suitable for installation in open air, in cable trays, conduit or other approved raceways. Minimum cable temperature rating 90°C dry locations, 75°C wet locations. Passes vertical tray flame test.
 - b. Individual Conductors: No. 14 AWG, 7-strand copper.
 - c. Insulation and Jackets: Provide conductors having 15-mil PVC insulation with 4-mil nylon jacket, and UL listed as Type THHN/THWN.

2.04 CABLES FOR VARIABLE FREQUENCY MOTORS

- A. General: All AC motors rated 600 volt (maximum) which are powered from AC Variable Frequency Drives (VFDs), so as to permit variable speed operation, shall be wired with shielded multiconductor Variable Frequency Drive Cable, specifically manufactured for that application in exposed applications. When in conduit, 600V THHN/THWN copper wire is acceptable
- B. Conform to NEC Article 336.
- C. Ratings
 1. 1,000 Volt UL flexible motor supply cable
 2. XLPE insulated, XHHW-2 90°C Wet/Dry
- D. Suitable for Class 1, Div. 2 hazardous locations.
- E. Suitable for direct burial, cable tray installation and conduit installation.
- F. Full-sized ground wire or equivalent.
- G. Overall shield with full-sized drain wire or equivalent.
- H. Belden Part No. 295XX, or approved equal.

2.05 TYPE 2 (600 VOLT NO. 16 AWG TWISTED, SHIELDED PAIR INSTRUMENTATION CABLE, TYPE TC)

- A. General: Single pair instrumentation cable designed for noise rejection for process control, computer, or data log applications. Suitable for installation in cable trays, conduit, or other approved raceways. Minimum cable temperature rating shall be 90°C dry locations, 75°C wet locations.
- B. Individual Conductors: Bare soft annealed copper, Class B, 7-strand concentric per ASTM B 8; 20 AWG, 7-strand tinned copper drain wire.
- C. Insulation and Jacket: Each conductor 15-mil nominal PVC and 4-mil nylon insulation. Pair conductors pigmented black and red. Jacket flame-retardant and sunlight and oil resistant PVC with 45-mil nominal thickness. Shield 1.35-mil aluminum/mylar overlapped to provide 100% coverage.

D. Dimension: 0.31-inch nominal OD.

2.06 TYPE 3 (600 VOLT NO. 16 AWG, MULTIPLE TWISTED SHIELDED PAIRS WITH A COMMON OVERALL SHIELD INSTRUMENTATION CABLE, TYPE TC)

A. General: Twisted, shielded pairs of instrument cables, grouped in a single cable, designed for use as instrumentation, process control, and computer cable. Suitable for installation in cable tray, conduit or other approved raceways. Minimum cable temperature rating shall be 90°C dry locations, 75°C wet locations.

B. Conductors: Bare soft annealed copper Class B, 7-strand, concentric per ASTM B 8. Tinned copper drain wires. Pair drain wire size AWG 20, group drain wire size AWG 18.

C. Insulation and Jacket: Each conductor 15-mil PVC and 4-mil nylon insulation. Pair conductors pigmented black and red with red conductor numerically printed for group identification. Outer jacket flame retardant and sunlight and oil resistant PVC with nominal thickness as shown in table. Individual pair shield 1.35-mil aluminum/mylar. Group shield 2.35-mil aluminum/mylar, overlapped for 100% coverage.

D. Dimensions as noted in table below:

No. of Pairs	Max. Outside Dimension (inches)	Nominal Jacket Thickness(mils)
4	0.50	45
8	0.77	60
12	0.82	60
24	1.16	60

2.07 TYPE 4 (600 VOLT NO. 16 AWG, SINGLE TWISTED, SHIELDED TRIAD INSTRUMENTATION CABLE)

A. General: Twisted, shielded triad instrument cables, designed for use as instrumentation, process control, and computer cable. Suitable for installation in cable tray, conduit or other approved raceways. Minimum cable temperature rating shall be 90°C dry locations, 75°C wet locations.

B. Conductors: Bare soft annealed copper Class B, 7-strand, concentric per ASTM B 8. Tinned copper drain wires. Triad drain wire size AWG 18.

C. Insulation and Jacket: Each conductor 15-mil PVC and 4-mil nylon insulation. Triad conductors pigmented black, white and red. Outer jacket flame retardant and sunlight and oil resistant PVC with nominal thickness. Individual triad shield 1.35-mil aluminum/mylar.

2.08 EQUIPMENT GROUNDING CONDUCTORS

- A. Provide stranded copper conductors, as indicated or as required by NEC, for equipment grounding.
- B. Provide conductors bare.

2.09 CONNECTORS

- A. General: Provide UL type factory-fabricated, metal connectors of sizes, ampacity ratings, materials, types and classes for applications and for services indicated. Where not indicated, provide proper selection as determined by Installer to comply with project's installation requirements, NFPA-70 and NEMA standards. Select from the following those types, classes, kinds and styles of connectors to fulfill project requirements:
 - 1. Type: Pressure
 - 2. Type: Crimp
 - 3. Type: Threaded
 - 4. Class: Insulated
 - 5. Kind: Copper (for CU to CU connection)
 - 6. Style: Butt connection
 - 7. Style: Elbow connection
 - 8. Style: Combined "T" and straight connection
 - 9. Style: "T" connection
 - 10. Style: 2 or 4 bolt parallel connection. Use of split bolt connectors is prohibited
 - 11. Style: Tap connection
 - 12. Style: Pigtail connection
 - 13. Style: Wire nut connection

PART 3 - EXECUTION

3.01 INSTALLATION OF WIRES AND CABLES

- A. General: Install electrical cables, wire and wiring connectors as indicated, in compliance with applicable requirements of NFPA-70, NEMA, UL, and NECA's "Standard of Installation" and in accordance with recognized industry practices.
- B. Coordinate wire/cable installation work including electrical raceway and equipment installation work, as necessary to properly interface installation of wires/cables with other work.
- C. Install UL type wiring in conduit, for feeders and branch circuits.
- D. Pull conductors simultaneously where more than 1 is being installed in same raceway.
- E. Use pulling compound or lubricant, where necessary; compound used must not deteriorate conductor or insulator.

- F. Use pulling means including, fish tape, cable, rope and basket weave wire/cable grips, which will not damage cables or raceways.
- G. Keep conductor splices to a minimum.
- H. Install splices and tapes, which possess equivalent or better mechanical strength and insulation ratings than conductors being spliced.
- I. Use splice and tap connectors, which are compatible with conductor material.
- J. Tighten electrical connectors and terminals, including screws and bolts, in accordance with manufacturer's published torque tightening values. Where manufacturer's torquing requirements are not indicated, tighten connectors and terminals to comply with tightening torques specified in UL Standard 486A and B.
- K. Use only stranded conductors. Exception: Solid conductors size #12 and #10 AWG may be used for receptacle branch circuit wiring and lighting.
- L. Use #10 AWG conductor for 20-ampere, 120-volt branch circuit home runs longer than 75-feet, and for 20-ampere, 277-volt branch circuit home runs longer than 200-feet.
- M. Neatly train and lace wiring inside boxes, equipment, and panel boards. Support to prevent conductor movement under fault conditions.
- N. All underground wiring shall be suitable for wet locations per NEC.
- O. Discrete control 120-VAC and 4-20mA signals must not be run in same conduit. Discrete control 120-VAC and 4-20mA signal wiring in control panels and cabinets shall be separated from each other and when required, should cross perpendicular with each other to reduce signal noise.
- P. Avoid unnecessary splices. Splice only in accessible junction or outlet boxes.
- Q. Make all connections with solderless lugs.
- R. Use mechanical connectors for low voltage splices, taps, fixture and motor connections.
- S. Use insulated spade type crimp on connectors for strap screw device terminals.
- T. Where possible use connectors with integral, insulating covers. Otherwise tape uninsulated conductors and connectors to 150% of the insulation value of conductor.
- U. Thoroughly clean wires before installing lugs and connectors.
- V. Make splices, taps and terminations to carry full ampacity of conductors without perceptible temperature rise.

3.02 FIELD QUALITY CONTROL

- A. Prior to energization of circuitry, check installed wires and cables with megohm meter to determine insulation resistance levels to ensure requirements are fulfilled.
- B. Prior to energization, test wires and cables for electrical continuity and for short circuits.
- C. Subsequent to wire and cable hook-ups, energize circuitry and demonstrate functioning in accordance with requirements. Where necessary, correct malfunctioning units, and then retest to demonstrate compliance.

END OF SECTION

1

THIS PAGE LEFT BLANK INTENTIONALLY

SECTION 16135
ELECTRICAL BOXES AND FITTINGS

PART 1 - GENERAL

1.01 RELATED DOCUMENTS

- A. Drawings and general provisions of Contract, including General and Supplementary Conditions and Division 1 Specification sections, apply to work of this Section.
- B. Work described in this Section includes furnishing all labor, materials, equipment, tools and incidentals required for a complete and operable installation of boxes, bushings and locknuts. All equipment shall be installed, adjusted, tested and placed in operation in accordance with these Specifications, the manufacturer's recommendations and as shown on the Drawings.

1.02 DESCRIPTION OF WORK

- A. Extent of electrical box and associated fitting work is indicated by drawings and schedules.
- B. Types of electrical boxes and fittings specified in this Section include the following:
 - 1. Outlet boxes
 - 2. Junction boxes
 - 3. Pull boxes
 - 4. Bushings
 - 5. Locknuts

1.03 QUALITY ASSURANCE

- A. Manufacturers: Firms shall have sufficient experience that will allow for quality and successful manufacture of electrical boxes and fittings of types, sizes and capacities required for manufacture of electrical boxes and fittings required for use in this Project.
- B. Installer's Qualifications: Firms shall have sufficient experience that will allow for quality and successful installation of electrical boxes and fittings required for this Project.
- C. NFPA-70 Compliance: Comply with NFPA-70 as applicable to construction and installation of electrical wiring boxes and fittings.
- D. UL Compliance: Comply with applicable requirements of UL 50, UL 514 Series, and UL 886 pertaining to electrical boxes and fittings which are UL listed and labeled.

- E. NEMA Compliance: Comply with applicable requirements of NEMA Standard Publication Numbers OS1, OS2, and Pub.250 pertaining to outlets and device boxes, covers and box supports.
- F. Comply with NECA "Standard of Installation."
- G. Listing and Labeling: Provide products specified in this Section that are listed and labeled.
 - 1. The Terms "Listed" and "Labeled." As defined in the "National Electrical Code", Article 100.
 - 2. Listing and Labeling Agency Qualifications: A "Nationally Recognized Testing Laboratory" (NRTL) as defined in OSHA Regulation 1910.7.

1.04 SHOP DRAWINGS AND SUBMITTALS

- A. Submittals shall be submitted to the County/Professional for review and acceptance prior to construction in accordance with the General Conditions and specifications Section 01300 "Submittals."
- B. Product Data: Submit manufacturer's data on electrical boxes and fittings.
- C. A copy of this specification section with addendum updates included, and all referenced and applicable sections with addendum updates included, with each paragraph check-marked to indicate specification compliance or marked to indicate requested deviations from specification requirements. Check marks shall denote full compliance with a paragraph as a whole.
- D. If deviations from the specifications are indicated and therefore requested by the Contractor, each deviation shall be underlined and denoted by a number in the margin to the right of the identified paragraph, referenced to a detailed written explanation of the reasons for requesting the deviation.
- E. The County shall be the final authority for determining acceptability of requested deviations. The remaining portions of the paragraph not underlined will signify compliance on the part of the Contractor with the specifications.
- F. Failure to include a copy of the marked-up specification sections along with justification(s) for any requested deviations to the specification requirements, with the submittal shall be sufficient cause for rejection of the entire submittal with no further consideration.

PART 2 - PRODUCTS

2.01 GENERAL

- A. All material supplied shall be one of the products specified in Appendix D "List of Approved Products" appended to these technical specifications.

2.02 FABRICATED MATERIALS

- A. Outlet Boxes: Provide corrosion resistant cast metal rain tight outlet wiring boxes, of types, shapes and sizes, including depth of boxes, with threaded conduit holes for fastening electrical conduit, cast metal face plates with spring-hinged watertight caps suitably configured for each application, including face plate gaskets and corrosion resistant plugs and fasteners.
 1. Manufacturers: Subject to compliance with requirements, provide rain tight outlet boxes of 1 of the following:
 - a. Appleton Electric; Emerson Electric Co.
 - b. Arrow Hart Div.; Crouse-Hinds Co.
 - c. Bell Electric; Square D Co.
 - d. Harvey Hubbell, Inc.
 - e. OZ/Gedney; General Signal Co.
 - f. Pass and Seymour, Inc.
- B. Junction and Pull Boxes: Provide NEMA 4X Stainless Steel junction and pull boxes, with screw-on covers; of types, shapes, and sizes to suit each respective location and installation; with welded seams and equipped with stainless steel nuts, bolts, screws and washers.
 1. Manufacturers: Subject to compliance with requirements, provide junction and pull boxes of 1 of the following:
 - a. Adalet-PLM Div.; Scott Fetzer Co.
 - b. Appleton Electric; Emerson Electric Co.
 - c. Arrow Hart Div.; Crouse Hinds-Co.
 - d. Bell Electric; Square D Company
 - e. OZ/Gedney Co.; General Signal Co.
 - f. Spring City Electrical Mfg. Co.
- C. Bushings, Knockout Closures and Locknuts: Provide corrosion resistant box knockout closures, conduit locknuts and malleable iron conduit bushings, offset connectors, of types and sizes, to suit respective installation requirements and applications.
 1. Manufacturers: Subject to compliance with requirements, provide bushings, knockout closures, locknuts and connectors of 1 of the following:
 - a. Adalet-PLM Div.; Scott Fetzer Co.
 - b. AMP, Inc.
 - c. Arrow Hart Div.; Crouse-Hinds Co.
 - d. Appleton Electric Co.; Emerson Electric Co.
 - e. Bell Electric; Square D Co.
 - f. Midland Ross Corp.

- g. Midwest Electric; Cooper Industries, Inc.
- h. OZ/Gedney Co.; General Signal Co.
- i. RACO Div.; Harvey Hubbell, Inc.
- j. Thomas and Betts Co. Inc.

PART 3 - EXECUTION

3.01 INSTALLATION OF ELECTRICAL BOXES AND FITTINGS

- A. General: Install electrical boxes and fittings as indicated, in accordance with manufacturer's written instructions, applicable requirements of NFPA-70 and NECA's "Standard of Installation", and in accordance with recognized industry practices to fulfill project requirements.
- B. Coordinate installation of electrical boxes and fittings with wire/cable, wiring devices, and raceway installation work.
- C. Provide weather tight outlets at all locations.
- D. Provide knockout closures to cap unused knockout holes where blanks have been removed.
- E. Install electrical boxes in those locations, which ensure ready accessibility to enclosed electrical wiring.
- F. Fasten electrical boxes firmly and rigidly to substrates, or structural surfaces to which attached, or solidly embed electrical boxes in concrete or masonry.
- G. Provide electrical connections for installed boxes.
- H. Subsequent to installation of boxes, protect boxes from construction debris and damage.

3.02 GROUNDING

- A. Upon completion of installation work, properly ground electrical boxes and demonstrate compliance with requirements.

END OF SECTION

SECTION 16142
ELECTRICAL CONNECTIONS FOR EQUIPMENT

PART 1 - GENERAL

1.01 RELATED DOCUMENTS

- A. Drawings and general provisions of Contract, including General and Supplementary Conditions and Division 1 Specifications sections, apply to work of this Section.
- B. Work described in this Section includes furnishing all labor, materials, equipment, tools and incidentals required for a complete and operable installation of all electrical connections for wiring systems rated 600 volts or less. All electrical connections shall be installed, adjusted, tested and placed in operation in accordance with these Specifications, the manufacturer's recommendations and as shown on the Drawings.

1.02 DESCRIPTION OF WORK

- A. Extent of electrical connections for equipment is indicated by drawings and schedules. Electrical connections are hereby defined to include connections used for providing electrical power to equipment.
- B. Applications of electrical power connections specified in this Section include the following, but not limited:
 - 1. From electrical source to control panel
 - 2. From control panel to motors and control devices
- C. Electrical connections for equipment, not furnished as integral part of equipment, are specified in Division 15 and other Division 16 sections, and are work of this Section.
- D. Refer to Division 15 sections for motor starters and controller furnished integrally with equipment; not work of this Section.
- E. Junction boxes and disconnect switches required for connecting motors and other electrical units of equipment are specified in applicable Division 16 sections, and are work of this Section.
- F. Raceways and wires/cables required for connecting motors and other electrical units of equipment are specified in applicable Division 16 sections, and are work of this Section.
- G. Refer to Division 15 or Division 13 sections as applicable for control system wiring; not work of this Section.
- H. Refer to sections of other Divisions for specific individual equipment power requirements, not work of this Section.

1.03 QUALITY ASSURANCE

- A. Manufacturers: Firms shall have sufficient experience and be regularly engaged in manufacture of electrical connectors and terminals, of types and rating required, and ancillary connection materials, including electrical insulating tape, soldering fluxes, and cable ties, whose products have been in satisfactory use in projects with similar service as this Project.
- B. Installer's Qualifications: Firms shall have sufficient experience to allow for quality and successful installation utilizing electrical connections for equipment for this Project.
- C. NFPA-70 Compliance: Comply with applicable requirements of NFPA-70 as to type of products used and installation of electrical power connections (terminals and splices), for junction boxes, motor starters and disconnect switches.
- D. IEEE Compliance: Comply with Std. 241, "IEEE Recommended Practice for Electric Power Systems in Commercial Buildings" pertaining to connections and terminations.
- E. ANSI Compliance: Comply with applicable requirement of ANSI/NEMA and ANSI/EIA standards pertaining to products and installation of electrical connections for equipment.
- F. UL Compliance: Comply with UL Std.486A, "Wire Connectors and Soldering Lugs for Use with Copper Conductors" including, but not limited to, tightening of electrical connectors to torque values indicated. Provide electrical connection products and materials which are UL listed and labeled.

1.04 SHOP DRAWINGS AND SUBMITTALS

- A. Submittals shall be submitted to the County/Professional for review and acceptance prior to construction in accordance with the General Conditions and specifications Section 01300 "Submittals."
- B. Product Data: Submit manufacturer's data on electrical connections for equipment products and materials.
- C. A copy of this specification section with addendum updates included, and all referenced and applicable sections with addendum updates included, with each paragraph check-marked to indicate specification compliance or marked to indicate requested deviations from specification requirements. Check marks shall denote full compliance with a paragraph as a whole.
- D. If deviations from the specifications are indicated, and therefore requested by the Contractor, each deviation shall be underlined and denoted by a number in the margin to the right of the identified paragraph, referenced to a detailed written explanation of the reasons for requesting the deviation.
- E. The County shall be the final authority for determining acceptability of requested deviations. The remaining portions of the paragraph not underlined will signify compliance on the part of the Contractor with the specifications.

- F. Failure to include a copy of the marked-up specification sections along with justification(s) for any requested deviations to the specification requirements, with the submittal shall be sufficient cause for rejection of the entire submittal with no further consideration.

PART 2 - PRODUCTS

2.01 GENERAL

- A. All material supplied shall be one of the products specified in Appendix D "List of Approved Products" appended to these technical specifications.

2.02 ACCEPTABLE MANUFACTURERS

- A. Manufacturers: Subject to compliance with requirements, provide products of one of the following (for each type of product):
 1. Adalet PLM Div., Scott and Fetzer Co.
 2. Allen Stevens Conduit Fittings Corp.
 3. AMP Inc.
 4. Appleton Electric Co.
 5. Arrow Hart Div., Crouse Hinds Co.
 6. Burndy Corp.
 7. General Electric Co.
 8. Harvey Hubbell Inc.
 9. Ideal Industries, Inc.
 10. Pyle National Co.
 11. Reliable Electric Co.
 12. Square D Company
 13. Thomas and Betts Corp.

2.03 MATERIALS AND COMPONENTS

- A. General: For each electrical connection indicated, provide complete assembly of materials, including but not necessarily limited to; pressure connectors, terminals (lugs), electrical insulating tape, heat shrinkable insulating tubing, cables ties, solderless wire nuts, and other items and accessories as needed to complete splices and terminations of types indicated.

2.04 CONDUIT, TUBING AND FITTINGS

- A. General: Provide conduit, tubing, and fittings of types, grades, sizes, and weights (wall thickness) indicated for each type service. Where types and grades are not indicated, provide proper selection to fulfill wiring requirements, and comply with NFPA-70 requirements for raceways. Provide products complying with Section 16110 "Raceways" and in accordance with the following listing of conduit, tubing and fittings:
 1. Schedule 80 PVC conduit
 2. Schedule 80 PVC fittings

3. Liquid-tight flexible metal conduit
4. Liquid-tight flexible metal conduit fittings
5. Rigid aluminum conduit
6. Rigid aluminum conduit fittings

2.05 WIRES, CABLES AND CONNECTORS

- A. General: Provide wires, cables, and connectors complying with Section 16120 "Wires and Cables."
- B. Wires/Cables: Unless otherwise indicated, provide wires/cables (conductors) for electrical connections which match, including sizes and ratings, of wires/cables which are supplying electrical power. Provide copper conductors with conductivity of not less than 98% at 20°C (68°F)
- C. Connectors and Terminals: Provide electrical connectors and terminals which mate and match, including sizes and ratings, with equipment terminals and are recommended by equipment manufacturer for intended applications.
- D. Electrical Connection Accessories: Provide electrical insulating tape, heat shrinkable insulating tubing and boots, wire nuts and cable ties as recommended for use by accessories manufacturers for type services indicated.

PART 3 - EXECUTION

3.01 INSPECTION

- A. Inspect area and conditions under which electrical connections for equipment are to be installed and notify Contractor in writing of conditions detrimental to proper completion of the Work. Do not proceed with the Work until unsatisfactory conditions have been corrected in a manner acceptable to Installer and/or owner as applicable.

3.02 INSTALLATION OF ELECTRICAL CONNECTIONS

- A. Install electrical connections as indicated; in accordance with equipment manufacturer's written instructions and with recognized industry practices, and complying with applicable requirements of UL, NFPA-70, and NECA's "Standard of Installation" to ensure that products fulfill requirements.
- B. Coordinate with other work, including wires/cables, raceways and equipment installation, as necessary to properly interface installment of electrical connections for equipment with other work.
- C. Connect electrical power supply conductors to equipment conductors in accordance with equipment manufacturer's written instructions and wiring diagrams. Mate and match conductors of electrical connections for proper interface between electrical power supplies and installed equipment.

- D. Cover splices with electrical insulating material equivalent to, or of greater insulation resistivity ratings, than electrical insulation rating of those conductors being spliced.
- E. Prepare cables and wires, by cutting and stripping covering armor, jacket, and insulation properly to ensure uniform and neat appearance where cables and wires are terminated. Exercise care to avoid cutting through tapes, which will remain on conductors. Also avoid "ringing" copper conductors while skinning wire.
- F. Tighten connectors and terminals, including screws and bolts, in accordance with equipment manufacturers published torque-tightening values for equipment connectors. Accomplish tightening by utilizing proper torquing tools, including torque screwdriver, bean type torque wrench, and ratchet wrench with adjustable torque settings. Where manufacturer's torquing requirements are not available, tighten connectors and terminals to comply with torquing values contained in UL's 486A.
- G. Provide liquid tight flexible conduit for connections of motors and other electrical equipment where subject to movement and vibration.
- H. Fasten identification markers to each electrical power supply wire/cable conductor which indicates their voltage, phase and feeder number in accordance with Section 16195 "Electrical Identification." Affix markers on each terminal conductor, as close as possible to the point of connection.

3.03 FIELD QUALITY CONTROL

- A. Upon completion of installation of electrical connections, and after circuitry has been energized with rated power source, test connections to demonstrate capability and compliance with requirements. Ensure that direction of rotation of each motor fulfills requirement. Correct malfunctioning units at site, then retest to demonstrate compliance.

END OF SECTION

1

THIS PAGE LEFT BLANK INTENTIONALLY

SECTION 16143
WIRING DEVICES

PART 1 - GENERAL

1.01 RELATED DOCUMENTS

- A. Drawings and general provisions of Contract, including General and Supplementary Conditions and Division 1 Specification sections, apply to work of this Section.

1.02 DESCRIPTION OF WORK

- A. The extent of wiring device work is indicated by drawings and schedules. Wiring devices are defined as single discrete units of electrical distribution systems which are intended to carry but not utilize electrical energy.
- B. Work described in this Section includes furnishing all labor, materials, equipment, tools and incidentals required for a complete and operable installation of wall switches, receptacles, plugs, device plates and box covers. All equipment shall be installed, adjusted, tested and placed in operation in accordance with these Specifications, the manufacturer's recommendations and as shown on the Drawings.
- C. Types of electrical wiring devices in this Section include the following:
 - 1. Receptacles
 - 2. Ground fault circuit interrupters
 - 3. Switches

1.03 QUALITY ASSURANCE

- A. Manufacturers: Firms shall have sufficient experience in manufacture of electrical wiring devices, of types, sizes, and ratings required that will allow for quality and successful manufacture of wiring devices required for this Project.
- B. Installer's Qualifications: Firms shall have sufficient experience to allow for quality and successful installation of wiring devices required for this Project.
- C. NFPA-70 Compliance: Comply with NFPA-70 as applicable to installation and wiring of electrical wiring devices.
- D. UL Compliance: Comply with applicable requirements of UL 20, 486A, 498, and 943 pertaining to installation of wiring devices. Provide wiring devices which are UL listed and labeled.

- E. IEEE Compliance: Comply with applicable requirements of IEEE Standard 241, "Recommended Practice for Electric Power Systems in Commercial Buildings", pertaining to electrical wiring systems.
- F. NEMA Compliance: Comply with applicable portions of NEMA Standards Publication Number WD 1, "General Purpose Wiring Devices," and WD 5 "Specific Purpose Wiring Devices."
- G. OSHA Compliance: Comply with latest standards of the U.S. Department of Labor, Occupational Safety and Health Administration.
- H. Listing and Labeling: Provide products that are listed and labeled for their applications and installation conditions and for the environments in which installed.
 - 1. The Terms "Listed" and "Labeled": As defined in the "National Electrical Code," Article 100.
 - 2. Listing and Labeling Agency Qualifications: A "Nationally Recognized Testing Laboratory" (NRTL) as defined in OSHA Regulation 1910.7.

1.04 SHOP DRAWINGS AND SUBMITTALS

- A. Submittals shall be submitted to the County/Professional for review and acceptance prior to construction in accordance with the General Conditions and specifications Section 01300 "Submittals."
- B. Product Data: Submit manufacturer's data on electrical wiring devices.
- C. A copy of this specification section, with addendum updates included, and all referenced and applicable sections, with addendum updates included, with each paragraph check-marked to indicate specification compliance or marked to indicate requested deviations from specification requirements. Check marks shall denote full compliance with a paragraph as a whole.
- D. If deviations from the specifications are indicated, and therefore requested by the Contractor, each deviation shall be underlined and denoted by a number in the margin to the right of the identified paragraph, referenced to a detailed written explanation of the reasons for requesting the deviation.
- E. The County shall be the final authority for determining acceptability of requested deviations. The remaining portions of the paragraph not underlined will signify compliance on the part of the Contractor with the specifications.
- F. Failure to include a copy of the marked-up specification sections, along with justification(s) for any requested deviations to the specification requirements, with the submittal shall be sufficient cause for rejection of the entire submittal with no further consideration.

PART 2 - PRODUCTS

2.01 GENERAL

- A. All material supplied shall be one of the products specified in Appendix D "List of Approved Products" appended to these technical specifications.

2.02 ACCEPTABLE MANUFACTURERS

- A. Manufacturers: Subject to compliance with requirements, provide wiring devices of one of the following (for each type and rating of wiring device):
 1. Arrow Hart Div., Crouse Hinds Co.
 2. Bryant Electric Co.
 3. Harvey Hubbell Inc.
 4. Leviton Mfg. Co.
 5. Pass and Seymour Inc.
 6. Crouse Hinds.
 7. Appleton.
 8. Or approved equal.
- B. Wiring devices shall be UL approved for the current and voltage specified and shall comply with NEMA WD 1. Devices shall contain provisions for back wiring and side wiring with captive binding screws.

Provide devices colored to conform to manufacturer's or industry standard for special use such as orange for isolated ground receptacles, blue for surge suppression receptacles, and red for emergency power receptacles. Unless shown otherwise on the Drawings or Schedules, normal use devices shall be gray, except those located in finished areas shall be ivory.

2.03 FABRICATED WIRING DEVICES

- A. General: Provide factory fabricated wiring devices, in types, colors, and electrical ratings for applications indicated and which comply with NEMA Standards Publication Number WD 1.

2.04 RECEPTACLES

- A. Comply with NEMA Standard WD 1.
- B. Enclosures: NEMA 1 equivalent, except as otherwise indicated.
- C. Color: Unless noted otherwise by Architect or required by Code.
 1. Surface mounted unfinished areas: Gray.
 2. Flush mounted finished areas: Ivory.

- D. Receptacles, Straight-Blade and Locking Type: Comply with UL Standard 498, heavy-duty specification grade except as otherwise indicated.
- E. Receptacles, Straight-Blade, Special Features: Comply with the basic requirements specified herein for straight-blade receptacles of the class and type indicated, and with the following additional requirements:
 - 1. Ground-Fault Circuit Interrupter (GFCI) Receptacles: UL Standard 943, feed-through type, with integral NEMA 5-20R duplex receptacles arranged to protect connected downstream receptacles on the same circuit. Design units for installation in a 2-1/2-inch deep outlet box without an adapter. Ground-fault trip level shall be 5 milliamperes, and shall be noise-suppressed to the extent that nuisance tripping will be either eliminated or minimized.
 - 2. Line and load terminal screws: Ensure that connection to load terminals will ensure ground fault protection for other receptacles and loads connected to those terminals.
- F. Receptacles, Industrial Heavy-Duty: Conform to NEMA Standard PK 4.
- G. Except as otherwise noted on the Drawings or specified herein, receptacles shall be 125 Volt, 20-Ampere, ANSI C73.12, configuration 5-20R; grounded type; conforming to FS W-C-596/41 for single and FS W-C-596/40 for duplex receptacles and shall accept NEMA 5-15P and 5-20P plugs. Where the manufacturer of cord-connected equipment requires an isolated ground, a receptacle with isolated ground shall be provided.
- H. Ground Fault Interrupter (GFI) Receptacles: Provide duplex specification grade GFI receptacles tripping at 5-milliamperes; rated 20-amperes, 120 volts, NEMA Configuration 5-20R. Use units meeting NEMA WD 1, fitting standard sized outlet boxes having provision for testing, and ivory in color. Use standard model where ground fault protection is needed. Acceptable manufacturers are Square D, General Electric, or equal.
- I. Except as otherwise noted on the Drawings or specified herein, outdoor, process corrosive and chemical areas, receptacles shall be duplex, 20-ampere, NEMA 5-20R, and shall accept NEMA 5-15P and 5-20P plugs. Receptacle and plug shall be corrosion resistant but not marine duty with weatherproof lift covers. For outdoor locations use plastic or Lexan phenolic cover which can maintain the weatherproof integrity while in use.
- J. Receptacles shall be side or back wired with two screws per terminal.
- K. Body shall be thermoplastic compound or impact resistant nylon face supported by mounting yoke having plaster ears.
- L. Three phase receptacles and plugs shall be suitable for 480 volt, 3-phase, 4-wire service, with ampere ratings as specified. Receptacles and plugs shall be designed so that the grounding pole is permanently connected to the housing. The grounding pole shall make contact before the line poles are engaged when the plug is connected to the receptacle housing. The plug sleeve shall also make contact with the receptacle housing before the line and load poles make contact. Receptacles shall be provided complete with cast back box, angle adapter, gaskets, and a gasketed screw-type, weathertight cap with chain fastener.

- M. Install convenience outlets, in suitable steel outlet boxes centered at the height of 18-inches above the finished floor, 6-inches above countertop or at the backsplash level, or as indicated on the Drawings. Coordinate with equipment and architectural Drawings.

2.05 SWITCHES

- A. Snap: General purpose switches NEMA WD-1, shall be quiet AC type, NRTL listed and labeled as complying with UL Standard 20 "General Use Snap Switches," and with Federal Specification W-S 896, specification grade, back and side wired, and shall be provided in accordance with rated capacities as required or as indicated on Drawings or Schedules. Switches shall match receptacles in color. Unless otherwise indicated switches shall be 20-amp, 120/277 volt, toggle handle.
- B. Double Snap: Provide general duty flush double pole AC quiet switches, 20-amperes, 120/277 volts, with mounting yoke insulated from mechanism, equip with plaster ears, switch handles, side wired screw terminals, with break off tab features, which allow wiring with separate or common feed.
- C. Switches shall be 20-ampere with weatherproof/corrosion resistant neoprene plate for corrosive and outdoor areas. Switches shall be mounted in "FS" type copper-free aluminum or PVC mounting boxes.
- D. Switches shall be totally enclosed, specification grade, rated 20-ampere, 277/120 volt AC; conforming to FS W-S-896E, with phenolic body, base and toggles.

2.06 WIRING DEVICE ACCESSORIES

- A. Cover plates: Provide cover plates for single and combination wiring devices, of types, sizes and with ganging and cutouts as indicated. Select plates which mate and match wiring devices to which attached. Construct with metal screws for securing plates to devices. Cover plates shall be cast ferrous or aluminum, weatherproof, gasketed type.

PART 3 - EXECUTION

3.01 INSTALLATION OF WIRING DEVICES

- A. Install wiring devices as indicated, in accordance with manufacturer's written instructions, applicable requirements of NFPA-70 and NECA's "Standard of Installation" and in accordance with recognized industry practices to fulfill project requirements.
- B. Coordinate with other work, including painting, electrical boxes and wiring work, as necessary to interface installation of wiring devices with other work.
- C. Install wiring devices only in electrical boxes, which are clean, free from excess building materials, dirt and debris.
- D. Install wiring devices after wiring work is completed.

- E. Tighten connectors and terminals, including screws and bolts, in accordance with equipment manufacturer's published torque tightening values for wiring devices. Where manufacturer's torquing requirements are not indicated, tighten connectors and terminals to comply with tightening torques specified in UL Standards 486A and B. Use properly scaled torque indicating hand tool.
- F. Unless noted otherwise on the Drawings, receptacles and jacks shall be mounted 18-inches above finished floor or approximately 6-inches above countertops, work surfaces or similar surfaces where applicable. Switches shall be mounted 48-inches above finished floor, unless noted otherwise. For wet or damp unfinished areas receptacles shall be mounted at 24-inches.
- G. Boxes shall be independently supported by galvanized brackets, expansion bolts, toggle bolts, or machine or wood screws as appropriate. Wooden plugs inserted in masonry or concrete shall not be used as a base to secure boxes, nor shall welding or brazing be used for attachment. Where installed outdoors or subject to corrosion, all supporting brackets shall be 316 Stainless Steel.

3.02 GROUNDING

- A. Provide equipment-grounding connections for wiring devices, unless otherwise indicated. Tighten connections to comply with tightening torques specified in UL Standard 486A to assure permanent and effective grounds.
- B. All wiring devices shall be grounded per Code.
- C. Isolated Ground Receptacles: Connect to isolated grounding conductor routed to designated isolated equipment ground terminal of electrical system.

3.03 TESTING

- A. Prior to energizing circuitry, test wiring for electrical continuity, and for short circuits. Ensure proper polarity of connections is maintained. Subsequent to energization, test wiring devices to demonstrate compliance with requirements.
- B. Testing: Test wiring devices for proper polarity and ground continuity. Operate each operable device at least 6 (six) times.
- C. Test ground-fault circuit interrupter operation with both local and remote fault simulations according to manufacturer recommendations.
- D. Replace damaged or defective components.

END OF SECTION

SECTION 16170
CIRCUIT AND MOTOR DISCONNECTS

PART 1 - GENERAL

1.01 RELATED DOCUMENTS

- A. Drawings and general provisions of Contract, including General and Supplementary Conditions and Division 1 Specification sections, apply to work of this Section.

1.02 DESCRIPTION OF WORK

- A. Extent of circuit and motor disconnect switch work is indicated on drawings and schedules.
- B. Work described in this Section includes furnishing all labor, materials, equipment, tools and incidentals required for a complete and operable installation of disconnect switches and enclosures. All equipment shall be installed, adjusted, tested and placed in operation in accordance with these Specifications, the manufacturer's recommendations and as shown on the Drawings. This section includes individually mounted switches used for the following:
 - 1. Equipment disconnects
 - 2. Motor circuit disconnects
- C. Refer to other Division 16 sections for wires/cables, raceways, and electrical boxes and fittings work required in connection with circuit and motor disconnect work; not work of this Section.

1.03 QUALITY ASSURANCE

- A. Manufacturers: Firms shall have sufficient experience in the manufacture of circuit and motor disconnect switches of types and capacities required, for quality and successful manufacture of circuit and motor disconnects.
- B. Installer's Qualifications: Firms shall have sufficient experience to allow for quality and successful installation of circuit and motor disconnects for use in this Project.
- C. NFPA-70 Compliance: Comply with NFPA-70 requirements pertaining to construction and installation of electrical circuit and motor disconnect devices.
- D. UL Compliance: Comply with requirements of UL 98, "Enclosed and Dead Front Switches." Provide circuit and motor disconnect switches which have been UL listed and labeled.

- E. NEMA Compliance: Comply with applicable requirements of NEMA Standards Publication Number KS 1, "Enclosed Switches" and 250 "Enclosures for Electrical Equipment" (1,000 volts maximum).
- F. Listing and Labeling: provide disconnect switches specified in this Section that are listed and labeled.
 - 1. The Terms "Listed" and "Labeled." As defined in the "National Electrical Code", Article 100.
 - 2. Listing and Labeling Agency Qualifications: A "Nationally Recognized Testing Laboratory" (NRTL) as defined in OSHA Regulation 1910.7.

1.04 SHOP DRAWINGS AND SUBMITTALS

- A. Submittals shall be submitted to the County/Professional for review and acceptance prior to construction in accordance with the General Conditions and specifications Section 01300 "Submittals."
- B. Data: Submit manufacturer's data on circuit and motor disconnect switches.
- C. A copy of this specification section, with addendum updates included, and all referenced and applicable sections, with addendum updates included, with each paragraph check-marked to indicate specification compliance or marked to indicate requested deviations from specification requirements. Check marks shall denote full compliance with a paragraph as a whole.
- D. If deviations from the specifications are indicated, and therefore requested by the Contractor, each deviation shall be underlined and denoted by a number in the margin to the right of the identified paragraph, referenced to a detailed written explanation of the reasons for requesting the deviation.
- E. The County shall be the final authority for determining acceptability of requested deviations. The remaining portions of the paragraph not underlined will signify compliance on the part of the Contractor with the specifications.
- F. Failure to include a copy of the marked-up specification sections, along with justification(s) for any requested deviations to the specification requirements, with the submittal shall be sufficient cause for rejection of the entire submittal with no further consideration.

PART 2 - PRODUCTS

2.01 GENERAL

- A. All material supplied shall be one of the products specified in Appendix D "List of Approved Products" appended to these technical specifications.

2.02 ACCEPTABLE MANUFACTURERS

- A. Manufacturer: Subject to compliance with requirements, provide circuit and motor disconnects of one of the following for each type of switch (refer to Appendix D "List of Approved Products."

2.03 DISCONNECTS

- A. Disconnects shall be rated for the maximum available fault current available at the point of connection. For 600V systems, an additional UL approved lockable, non-fused, safety type switch utility service disconnect shall be installed ahead of meter.
- B. Where pump motor disconnect and starter is not mounted within sight of pump wetwell, where electrical equipment is mounted within a building or other enclosure, provide additional NEMA 4X stainless steel 316 non-fused disconnect for each pump within sight of pump location.
- C. Enclosed, Non-fusible Switch: 600 Volts, heavy-duty, single throw safety switch, with lockable handle. Quantity of poles and ampere rating shall be as required to meet the application. Also, switches for motor applications shall be horsepower rated to meet or exceed the connected motor load. Square D Class 3110, or equal.
- D. Enclosure: As specified or required to meet environmental conditions of installed location:
 - 1. Dry Indoor Locations: NEMA 1
 - 2. Outdoor Locations: NEMA 3R, 316 Stainless Steel
 - 3. Wet, Damp or corrosive Locations: NEMA 4X , 316 Stainless Steel
 - 4. Below Grade Locations: NEMA 4, 316 Stainless Steel
 - 5. NEC Class 1 Hazardous Locations: NEMA 7 with applicable Group (A, B, C, D) rating.
- E. Switches shall have handles lockable with two padlocks and shall have a dual cover interlock.
- F. Disconnect switches used on single phase, 3-wire or 3-phase, 4-wire applications shall have a factory installed neutral assembly.
- G. Disconnect switches shall have a field installed grounding lug.

2.04 FUSES

- A. Enclosed, Fusible Switch: 600 Volts, heavy-duty, and single throw safety switch with lockable handle and with clips to accommodate specified fuses. Fuse size shall be per Contract Drawings and/or to match protected equipment manufacturers recommendation. Quantity of poles and ampere rating shall be as required to meet the application. Also, switches for motor applications shall be horsepower rated to meet or exceed the connected motor load. Square D Class 3110, or equal. Provide fuses for equipment as required and as recommended by switch manufacturer, of classes, types, and ratings needed to fulfill electrical requirements for service indicated.

PART 3 - EXECUTION

3.01 INSTALLATION OF CIRCUIT AND MOTOR DISCONNECT SWITCHES

- A. Install circuit and motor disconnect devices as indicated complying with manufacturer's written instructions, applicable requirements of NFPA-70, NEMA and NECA's "Standard of Installation," and in accordance with recognized industry practices.
- B. Connect disconnect switches and components to wiring system and to ground as indicated and instructed by manufacturer. Tighten electrical connectors and terminals according to manufacturer's published torque-tightening values. Where manufacturer's torque values are not indicated, use those specified in UL 486A and UL 486B.
- C. Coordinate circuit and motor disconnect device installation work with electrical raceway and cable work, as necessary for proper interface.
- D. Install disconnect devices for use with motor driven appliances, and motors and controllers within sight of controller position unless otherwise indicated.

3.02 GROUNDING

- A. Provide equipment grounding connections, sufficiently tight to assure a permanent and effective ground, for electrical disconnect switches per the National Electrical Code (NEC).

3.03 FIELD QUALITY CONTROL

- A. Subsequent to completion of installation of electrical disconnect switches, energize circuitry and demonstrate capability and compliance with requirements. Correct malfunction units at project site where possible, then retest to demonstrate compliance; otherwise remove and replace with new units and retest.

END OF SECTION

SECTION 16180
OVER CURRENT PROTECTIVE DEVICES

PART 1 - GENERAL

1.01 RELATED DOCUMENTS

- A. Drawings and general provisions of Contract, including General and Supplementary Conditions and Division 1 Specification sections, apply to work of this Section.

1.02 DESCRIPTION OF WORK

- A. Extent of over-current protective device work is indicated by drawings and schedules.
- B. Work described in this Section includes furnishing all labor, materials, equipment, tools and incidentals required for a complete installation of all electrical equipment and systems with over-current protection. All equipment shall be installed, adjusted, tested and placed in operation in accordance with these Specifications, the manufacturer's recommendations and as shown on the Drawings. Types of over-current protective devices in this Section include the following:
 - 1. Circuit Breakers
 - a. Molded Case
- C. Refer to other Division 16 sections for cable/wire and connector work required in conjunction with over-current protective devices; not work of this Section.

1.03 QUALITY ASSURANCE

- A. Manufacturers: Firms shall have sufficient experience in the manufacture of over-current protective devices, of types, sizes, and ratings required, for quality and successful manufacture of over-current and protective devices for use in this Project.
- B. Installer: Firms shall have sufficient experience to allow for quality and successful installation of over-current and protective devices required for this Project.
- C. NFPA-70 Compliance: Comply with NFPA-70 requirements as applicable to construction and installation of over-current protective devices.
- D. UL Compliance: Comply with applicable requirements of UL 489, "Molded Case Circuit Breakers and Circuit Breaker Enclosures." Provide over-current protective devices which are UL listed and labeled.
- E. NEMA Compliance: Comply with applicable requirements of NEMA Standard Publication Numbers AB 1, AB 2, and SG 3 pertaining to molded case and low voltage power type circuit breakers.

- F. Listing and Labeling: Provide products specified in this Section that are listed and labeled.
 - 1. The Terms "Listed and Labeled." As defined in the "National Electrical Code," Article 100.
 - 2. Listing and Labeling Agency Qualifications: A "Nationally Recognized Testing Laboratory" (NRTL) as defined in OSHA Regulation 1910.7.

1.04 SHOP DRAWINGS AND SUBMITTALS

- A. Submittals shall be submitted to the County/Professional for review and acceptance prior to construction in accordance with the General Conditions and specifications Section 01300 "Submittals."
- B. Product Data: Submit manufacturer's data on over-current protective devices, including amperes, voltages, and current ratings, interrupting ratings, current limitations, internal inductive and non-inductive loads, time current trip characteristic curves, and mounting requirements.
- C. A copy of this specification section with addendum updates included, and all referenced and applicable sections with addendum updates included, with each paragraph check-marked to indicate specification compliance or marked to indicate requested deviations from specification requirements. Check marks shall denote full compliance with a paragraph as a whole.
- D. If deviations from the specifications are indicated, and therefore requested by the Contractor, each deviation shall be underlined and denoted by a number in the margin to the right of the identified paragraph, referenced to a detailed written explanation of the reasons for requesting the deviation.
- E. The County shall be the final authority for determining acceptability of requested deviations. The remaining portions of the paragraph not underlined will signify compliance on the part of the Contractor with the specifications.
- F. Failure to include a copy of the marked-up specification sections along with justification(s) for any requested deviations to the specification requirements with the submittal, shall be sufficient cause for rejection of the entire submittal with no further consideration.

PART 2 - PRODUCTS

2.01 GENERAL

- A. All material supplied shall be one of the products specified in Appendix D "List of Approved Products" appended to these technical specifications.

2.02 ACCEPTABLE MANUFACTURERS

- A. Manufacturers: Subject to compliance with requirements, provide products of one of the following (for each type and rating of over-current protective device.)
1. Circuit Breakers: (See Appendix D "List of Approved Products".)

2.03 CIRCUIT BREAKERS

- A. General: Except as otherwise indicated, provide circuit breakers and ancillary components, of types, sizes, ratings and electrical characteristics indicated, which comply with manufacturer's standard design, materials, components, and construction in accordance with published product information and as required for a complete installation.
- B. Molded Case Circuit Breakers: Provide factory assembled, molded case circuit breakers of frame size indicated. Provide breakers with permanent thermal and instantaneous magnetic trips in each pole, and with fault current limiting protection, ampere rating as indicated. Construct with over center, trip free, toggle type operating mechanisms with quick make, quick break action and positive handle trip indication. Provide push to trip button on cover for mechanical tripping circuit breakers. All latch surfaces shall be ground and polished. All poles shall be so constructed that they open, close and trip simultaneously. Circuit breakers must be completely enclosed in a high strength polyester molded case. Ampere rating shall be clearly visible. Contacts shall be on non-welding silver alloy. Arc extinction must be accomplished by means of arc chutes. Construct breakers for mounting and operating in any physical position and operating in an ambient temperature of 40°C. Provide breakers with mechanical screw type removable connector lugs, AL/CU rated. Mount individual circuit breakers complying with requirements for circuit breakers in this Section in enclosure required for the location, unless otherwise indicated. Provide circuit breakers with handles that can be locked in the OFF position. Interlock enclosure and circuit breaker to prevent opening the cover with the circuit breaker in the ON position. Provide thermal magnetic circuit breaker, unless otherwise shown, for one-pole and two pole breakers, breakers operating at 240V or less, and 3 (three) pole branch circuit breakers operating at 480V.

PART 3 - EXECUTION

3.01 INSTALLATION OF OVER CURRENT PROTECTIVE DEVICES

- A. Install over current protective devices as indicated, in accordance with manufacturer's written instructions and with recognized industry practices to ensure that protective devices comply with requirements. Comply with NFPA-70 and NEMA standards for installation of over current protective devices.
- B. Coordinate with other work, including electrical wiring work, as necessary to interface installation of over current protective devices with other work.

- C. Fasten circuit breakers without causing mechanical stresses, twisting or misalignment being exerted by clamps, supports, or cabling.
- D. Set field adjustable circuit breakers for trip settings as indicated, subsequent to installation of units.

3.02 ADJUST AND CLEAN:

- A. Inspect circuit breakers operating mechanisms for malfunctioning and, where necessary, adjust units for free mechanical movement.

3.03 FIELD QUALITY CONTROL

- A. Prior to energizing of over current protective devices, test devices for continuity of circuitry and for short circuits. Correct malfunctions in units, and then demonstrate compliance with requirements.

END OF SECTION

SECTION 16190
SUPPORTING DEVICES

PART 1 - GENERAL

1.01 RELATED DOCUMENTS

- A. Drawings and general provisions of Contract, including General and Supplementary Conditions, and Division 1 Specification sections, apply to work of this Section.

1.02 DESCRIPTION OF WORK

- A. Extent of supports, anchors, sleeves and seals is indicated by drawings and schedules and/or specified in other Division 16 sections.
- B. Types of supports, anchors, sleeves and seals specified in this Section include the following:
 - 1. C clamps
 - 2. Nuts and bolts
 - 3. One-hole conduit straps
 - 4. Round steel rods and associated hardware
 - 5. Support channels

1.03 QUALITY ASSURANCE

- A. Manufacturers: Firms shall sufficient experience in the manufacture of supporting devices, of types, sizes, and ratings required for quality and successful manufacture of supporting devices for use in this Project.
- B. Installers Qualifications: Firms shall sufficient experience to allow for quality and successful installation of supporting devices required for use in this Project.
- C. NFPA-70 Compliance: Comply with NFPA-70 requirements as applicable to construction and installation of electrical supporting devices.
- D. NECA Compliance: Comply with National Electrical Contractors Association's "Standard of Installation" pertaining to anchors, fasteners, hangers, supports, and equipment mounting.
- E. UL Compliance: Provide electrical components which are UL listed and labeled.
- F. Listing and Labeling: Provide products specified in this Section that are listed and labeled.
 - 1. The Terms "Listed and Labeled." As defined in the "National Electrical Code," Article 100.
 - 2. Listing and Labeling Agency Qualifications: A "Nationally Recognized Testing Laboratory" (NRTL) as defined in OSHA Regulation 1910.7.

1.04 SHOP DRAWINGS AND SUBMITTALS

- A. Submittals shall be submitted to the County/Professional for review and acceptance prior to construction in accordance with the General Conditions and specifications Section 01300 "Submittal."
- B. Product Data: Submit manufacturer's data on supporting devices including catalog cuts, specifications, and installation instructions, for each type of support, anchor, sleeve and seal.
- C. A copy of this specification section with addendum updates included, and all referenced and applicable sections with addendum updates included, with each paragraph check-marked to indicate specification compliance or marked to indicate requested deviations from specification requirements. Check marks shall denote full compliance with a paragraph as a whole.
- D. If deviations from the specifications are indicated, and therefore requested by the Contractor, each deviation shall be underlined and denoted by a number in the margin to the right of the identified paragraph, referenced to a detailed written explanation of the reasons for requesting the deviation.
- E. The County shall be the final authority for determining acceptability of requested deviations. The remaining portions of the paragraph not underlined will signify compliance on the part of the Contractor with the specifications.
- F. Failure to include a copy of the marked-up specification sections, along with justification(s) for any requested deviations to the specification requirements with the submittal shall be sufficient cause for rejection of the entire submittal with no further consideration.

PART 2 - PRODUCTS

2.01 GENERAL

- A. All material supplied shall be one of the products specified in Appendix D "List of Approved Products" appended to these technical specifications.

2.02 MANUFACTURED SUPPORTING DEVICES

- A. General: Provide supporting devices which comply with manufacturer's standard materials, design, and construction in accordance with published product information, and as required for complete installation; and as herein specified. Where more than one type of supporting device meets indicated requirement, selection is Installer's option.
- B. Supports: Provide supporting devices of types, sizes and materials indicated; and having the following construction features:
 - 1. C Clamps: Stainless Steel: 1/2-inch rod size; approximately 70-pounds per 100-units.
 - 2. I Beam Clamps: Stainless steel, 1-1/4-inch x 3/16-inch stock; 3/8-inch cross bolt; flange width 2-inches; approximately 52-pounds per 100-units.
 - 3. One-Hole Conduit Straps: For supporting 3/4-inch rigid metal conduit; stainless steel; approximately 7-pounds per 100-units.

4. Hexagon Nuts: For 1/2-inch rod size; stainless steel; approximately 4-pounds per 100-units.
 5. Threaded round Steel Rod: Stainless Steel; 1/2-inch dia.; approximately 67-pounds per 100-feet.
 6. Offset Conduit Clamps: For supporting rigid metal conduit; stainless steel.
- C. Anchors: Provide anchors of types, sizes, and materials indicated, with the following construction features:
1. Lead Expansion Anchors: 1/2-inch; approximately 38-pounds per 100-units.
 2. Toggle Bolts: Springhead; stainless steel 3/16-inch by 4-inches; approximately 5-pounds per 100-units.
 3. Manufacturers: Subject to compliance with requirements, provide anchors of one of the following:
 - a. Ideal Industries, Inc.
 - b. Joslyn Mfg. and Supply Co.
 - c. McGraw Edison Co.
 - d. Star Expansion Co.
 - e. U.S. Expansion Bolt Co.
- D. Sleeves and Seals: Provide sleeves and seals of types, sizes and materials indicated, with the following construction features:
1. U Channel Strut Systems: Provide U channel strut system for supporting electrical equipment, 12-gauge stainless steel, of types and sizes indicated; construct with 9/16-inch dia. holes, 8-inch on center on top surface, and with fittings which mate and match with U channel.
 2. Manufacturers: Subject to compliance with requirements, provide channel systems of one of the following:
 - a. Allied Tube and Conduit Corp.
 - b. B Line Systems, Inc.
 - c. Greenfield Mfg. Co., Inc.
 - d. Midland Ross Corp.
 - e. OZ/Gedney Div.; General Signal Corp.
 - f. Power Strut Div.; Van Huffel Tube Corp.
 - g. Unistrut Div.; GTE Products Corp.

PART 3 - EXECUTION

3.01 INSTALLATION OF SUPPORTING DEVICES

- A. Coordinate with other electrical work, including raceway and wiring work, as necessary to interface installation of supporting devices with other work.

END OF SECTION

THIS PAGE LEFT BLANK INTENTIONALLY

SECTION 16195
ELECTRICAL IDENTIFICATION

PART 1 - GENERAL

1.01 RELATED DOCUMENTS

- A. Drawings and general provisions of Contract, including General and Supplementary Conditions and Division 1 Specification sections, apply to work of this Section.
- B. Division 16 Basic Electrical Materials and Methods section apply to work specified in this Section.

1.02 DESCRIPTION OF WORK

- A. Extent of electrical identification work is indicated by drawings and schedules.
- B. Work described in this Section includes furnishing all labor, materials, equipment, tools and incidentals required for identification of electrical materials, equipment, and installations. All equipment shall be installed, adjusted, tested and placed in operation in accordance with these Specifications, the manufacturer's recommendations and as shown on the Drawings.

Types of electrical identification work specified in this Section include the following:

- 1. Electrical power, control and communication conductors
- 2. Operational instructions and warnings
- 3. Danger signs
- 4. Equipment/system identification signs

1.03 QUALITY ASSURANCE

- A. Manufacturers: Firms shall have sufficient experience in the manufacture of electrical identification products of types required, for quality and successful manufacture of electrical identification products for this Project.
- B. NFPA-70 Compliance: Comply with NFPA-70 as applicable to installation of identifying labels and markers for wiring and equipment.
- C. UL Compliance: Comply with applicable requirements of UL Standard 969, "Marking and Labeling Systems" pertaining to electrical identification systems.

- D. NEMA Compliance: Comply with applicable requirements of NEMA Standard Publication Numbers WC 1 and WC 2 pertaining to identification of power and control conductors.
- E. Listing and Labeling: provide disconnect switches specified in this Section that are listed and labeled.
 - 1. The Terms "Listed" and "Labeled." As defined in the National Electrical Code, Article 100.
 - 2. Listing and Labeling Agency Qualifications: A "Nationally Recognized Testing Laboratory" (NRTL) as defined in OSHA Regulation 1910.7.

1.04 SHOP DRAWINGS AND SUBMITTALS

- A. Submittals shall be submitted to the County/Professional for review and acceptance prior to construction in accordance with the General Conditions and specifications Section 01300 "Submittals."
- B. Product Data: Submit manufacturer's data on electrical identification materials and products.
- C. Samples: Submit samples of each color, lettering style and other graphic representation required for each identification material or system.
- D. A copy of this specification section with addendum updates included, and all referenced and applicable sections with addendum updates included, with each paragraph check-marked to indicate specification compliance or marked to indicate requested deviations from specification requirements. Check marks shall denote full compliance with a paragraph as a whole.
- E. If deviations from the specifications are indicated, and therefore requested by the Contractor, each deviation shall be underlined and denoted by a number in the margin to the right of the identified paragraph, referenced to a detailed written explanation of the reasons for requesting the deviation.
- F. The County shall be the final authority for determining acceptability of requested deviations. The remaining portions of the paragraph not underlined will signify compliance on the part of the Contractor with the specifications.
- G. Failure to include a copy of the marked-up specification sections, along with justification(s) for any requested deviations to the specification requirements, with the submittal shall be sufficient cause for rejection of the entire submittal with no further consideration.

PART 2 - PRODUCTS

2.01 GENERAL

- A. All material supplied shall be one of the products specified in Appendix D "List of Approved Products" appended to these technical specifications.

2.02 ACCEPTABLE MANUFACTURERS

- A. Manufacturers: Subject to compliance with requirements, provide electrical identification products of one of the following (for each type marker):
 1. Alarm Supply Co., Inc.
 2. American Labelmark Co., Labelmaster Subsidiary
 3. Brady, W.H. Co.
 4. Calpico Inc.
 5. Carlton Industries, Inc.
 6. Champion American, Inc.
 7. Cole Flex Corp.
 8. Direct Safety Co.
 9. George Ingraham Corp.
 10. Griffolyn Co.
 11. Ideal Industries, Inc.
 12. LEM Products, Inc.
 13. Markal Co.
 14. National Band and Tag Co.
 15. Panduit Corp.
 16. Seton Name Plate Co.
 17. Standard Signs, Inc.
 18. Tesa Corp.

2.03 ELECTRICAL IDENTIFICATION MATERIALS

- A. General: Except as otherwise indicated provide manufacturer's standard product of categories and types required for each application. Where more than single type is specified for an application, selection is Installer's option, but provides single selection for each application.
- B. Color Coded Plastic Tape
 1. General: Provide manufacturer's standard self-adhesive vinyl tape not less than 3-mil thick by 1-1/2-inches wide.
- C. Cable/Conductor Identification Bands
 1. General: Provide manufacturer's standard vinyl cloth self adhesive cable/conductor markers of wrap around type, either pre-numbered plastic coated type, or write on type with clear plastic self adhesive cover flap; numbered to show circuit identification.

D. Baked Enamel Danger Signs

1. General: Provide manufacturer's standard "DANGER" signs of baked enamel finish on 20-gauge steel, of standard red, black, and white graphics; 14-inches by 10-inches size except where 10-inches by 7-inches is the largest size which can be applied where needed, and except where larger size is needed for adequate vision; with recognized standard explanation wording, e.g., HIGH VOLTAGE, KEEP AWAY, BURIED CABLE, DO NOT TOUCH SWITCH.

E. Engraved Plastic Laminate Signs

1. General: Provide engraving stock melamine plastic laminate lamicoïd-type engraved nameplates, complying with FS L P 387, in sizes and thickness indicated, engraved with engraver's standard letter style of sizes and wording indicated, black face and white core plies (letter color) except as otherwise indicated, punched for mechanical fastening except where adhesive mounting is necessary because of substrate.
2. Thickness: 1/8-inch except as otherwise indicated.
3. Fasteners: Self-tapping stainless steel screws, except contact type permanent adhesive where screws cannot or should not penetrate substrate.

2.04 LETTERING AND GRAPHICS

- A. General: Coordinate names, abbreviations and other designations used in electrical identification work with corresponding designations shown, specified or scheduled. Provide numbers, lettering and wording as indicated or, if not otherwise indicated, as recommended by manufacturer or as required for proper identification and operation/maintenance of electrical system and equipment. Comply with ANSI A13.1 pertaining to minimum sizes for letters and numbers.

PART 3 - EXECUTION

3.01 APPLICATION AND INSTALLATION

A. General Installation Requirements

1. Install electrical identification products as indicated, in accordance with manufacturer's written instructions, and requirements of NFPA-70.
2. Coordination: Where identification is to be applied to surfaces which require finish, install identification after completion of painting.
3. Regulations: Comply with governing regulations and requests of governing authorities for identification of electrical work.

B. Conduit Identification

1. General: Where electrical conduit is exposed in spaces with exposed mechanical piping which is identified by color-coded method, apply color-coded identification on electrical conduit in manner similar to piping identification. Except as otherwise indicated use white as coded color for conduit.

C. Cable/Conductor Identification

1. General: Apply cable/conductor identification, including voltage, phase and feeder number, on each cable/conductor in each box/enclosure/cabinet where wires of more than one circuit or communication/signal system are present, except where another form of identification (such as color-coded conductors) is provided. Match identification with marking system used in panel boards, shop drawings, contract documents, and similar previously established identification for project's electrical work.
2. Color-Code Conductors: Secondary service, feeder, and branch circuit conductors throughout the secondary electrical system.
3. 208/120 Volt System: As follows:
 - a. Phase A: Black
 - b. Phase B: Red
 - c. Phase C: Blue
 - d. Neutral: White
 - e. Ground: Green
 - f. 480/277 Volt System: As follows:
 - g. Phase A: Brown
 - h. Phase B: Orange
 - i. Phase C: Yellow
 - j. Neutral: Gray
 - k. Ground: Green

D. Operational Identification and Warnings

1. General: Wherever reasonably required to ensure safe and efficient operation and maintenance of electrical systems, and electrically connected mechanical systems and general systems and equipment, including prevention of misuse of electrical facilities by unauthorized personnel, install self adhesive plastic signs or similar equivalent identification, instruction or warnings on switches, outlets, and other controls, devices and covers of electrical enclosures. Where detailed instructions or explanations are needed, provide plasticized tags with clearly written messages adequate for intended purposes.

E. Danger Signs

1. General: In addition to installation of danger signs required by governing regulations and authorities, install appropriate danger signs at locations indicated and at locations subsequently identified by Installer of electrical work as constituting similar dangers for persons in or about project.
2. High Voltage: Install danger signs wherever it is possible under any circumstances, for persons to come into contact with electrical power of voltages higher than 110 120 volts.

F. Equipment/Systems Identification

1. General: Install engraved plastic laminate signs on each major unit of electrical equipment in building; including central or master unit of each electrical system including communication/ control/signal systems, unless unit is specified with its own self-explanatory identification or signal system. Except as otherwise indicated, provide single line of text, 1/2-inch high lettering on 1-1/2-inch high sign (2-inches high where 2 lines are required), white lettering in black field. Provide text matching terminology and numbering of the Contract documents and Shop Drawings. Provide signs for each unit of the following categories of electrical work:
 - a. Electrical cabinets and enclosures
 - b. Access panel/doors to electrical facilities
 - c. Disconnect devices

- G. Install signs at locations indicated or, where not otherwise indicated, at location for best convenience of viewing without interference with operation and maintenance of equipment. Secure to substrate with fasteners, except use adhesive where fasteners should not or cannot penetrate substrate.

END OF SECTION

SECTION 16420
SERVICE ENTRANCE

PART 1 - GENERAL

1.01 RELATED DOCUMENTS

- A. Drawing and general provisions of Contract, including General and Supplementary Conditions and Division 1 Specifications sections, apply to work of this Section.

1.02 DESCRIPTION OF WORK

- A. Extent of service entrance work is indicated by drawings and schedules.
- B. Work described in this Section includes furnishing all labor, materials, equipment, tools and incidentals required for a complete installation of all electrical service entrance. All equipment shall be installed, adjusted, tested and placed in operation in accordance with these Specifications, the manufacturer's recommendations and as shown on the Drawings.

Types of service entrance equipment in this Section include the following:

- 1. Main Circuit Breaker and Surge Protector

- C. Refer to other Division 16 sections for wires/cables, raceways, and electrical boxes and fittings work required in connection with service entrance equipment; not work of this Section.

1.03 QUALITY ASSURANCE

- A. Manufacturers: Firms shall have sufficient experience in the manufacture of service entrance equipment of types, sizes and ratings required, for quality and successful manufacture of service entrance equipment for use in this Project.
- B. Installer's Qualifications: Firms shall have sufficient experience to allow for quality and successful installation of service entrance equipment required for this Project.
- C. NFPA-70 Compliance: Comply with NFPA-70 as applicable to construction and installation of service entrance equipment and accessories.
- D. NEMA Compliance: Comply with construction and installation requirements of the following NEMA standards for service entrance equipment and accessories:
 - 1. Standard Publication Number AB 1; Molded Case Circuit Breakers
- E. UL Compliance: Comply with construction and installation requirements of the following UL standards for service entrance equipment and accessories:
 - 1. UL 50; Electrical Cabinets and Boxes
 - 2. UL 869; Electrical Service Equipment

3. UL 1449: Transient Voltage Surge Suppressors, revised Edition, July 2, 1997
- F. Provide service entrance equipment, and accessories which are UL listed and labeled, and marked "SUITABLE FOR USE AS SERVICE EQUIPMENT."
- G. IEEE Compliance: Comply with applicable requirements of IEEE Standard 241 pertaining to service entrances.
- H. Listing and Labeling: provide disconnect switches specified in this Section that are listed and labeled.
 1. The Terms "Listed" and "Labeled." As defined in the National Electrical Code, Article 100.
 2. Listing and Labeling Agency Qualifications: A "Nationally Recognized Testing Laboratory" (NRTL) as defined in OSHA Regulation 1910.7.

1.04 SHOP DRAWINGS AND SUBMITTALS

- A. Submittals shall be submitted to the County/Professional for review and acceptance prior to construction in accordance with the General Conditions and specifications Section 01300 "Submittals."
- B. Product Data: Submit manufacturer's data on service entrance equipment and accessories.
- C. Shop Drawings: Submit dimensioned layouts of service entrance equipment, including spatial relationship to proximate electrical equipment.
- D. A copy of this specification section with addendum updates included, and all referenced and applicable sections with addendum updates included, with each paragraph check-marked to indicate specification compliance or marked to indicate requested deviations from specification requirements. Check marks shall denote full compliance with a paragraph as a whole.
- E. If deviations from the specifications are indicated, and therefore requested by the Contractor, each deviation shall be underlined and denoted by a number in the margin to the right of the identified paragraph, referenced to a detailed written explanation of the reasons for requesting the deviation.
- F. The County shall be the final authority for determining acceptability of requested deviations. The remaining portions of the paragraph not underlined will signify compliance on the part of the Contractor with the specifications.
- G. Failure to include a copy of the marked-up specification sections, along with justification(s) for any requested deviations to the specification requirements with the submittal shall be sufficient cause for rejection of the entire submittal with no further consideration.

PART 2 - PRODUCTS

2.01 GENERAL

- A. All material supplied shall be one of the products specified in Appendix D "List of Approved Products" appended to these technical specifications.

2.02 SERVICE ENTRANCE EQUIPMENT

- A. General: Provide service entrance equipment and accessories; of types, sizes, ratings, and electrical characteristics indicated, which comply with manufacturer's standard materials, design and construction in accordance with published product information, and as required for complete installation; and as herein specified.
- B. Over Current Protection Devices
 - 1. General: Provide over current protective devices complying with Section 16180 "Over Current Protective Devices."
- C. Cable/Wire
 - 1. General: Provide cable/wire complying with Section 16120 "Wires and Cables."
- D. Raceways
 - 1. General: Provide raceways complying with Section 16110 "Raceways."
- E. Surge Protection Devices (SP's)
 - 1. Provide surge protection device in accordance with the following requirements:
 - a. Comply with UL 1449 and 1283, current Edition and IEEE 62.41, 62.45.
 - b. Units shall be listed and labeled as meeting requirements of UL 1449 current Edition. The unit shall meet "Testing Requirements" of IEEE 62.41 and 62.45.
 - c. Provide SPD redundant modules providing with phase to phase, phase to neutral phase to ground and neutral to ground protection as applicable for service voltage.
 - d. Provide front panel alarm and test switch and redundant LED indicators to indicate alarm and/or normal operating conditions.
 - e. Provide SPD with AC tracking filter with EMI/RKI filtering up to - 50dB from 100K Hz to 100 MHz.
 - f. UL suppression voltage rating (240/480 volt rating).

L-N	L-G	N-G	L-L
400/800	400/800	400	800
 - g. SPD unit to match station available voltage and phase.
 - h. Minimum Amperes per Mode Suppression 80,000. For Master Stations (4 or more pumps) or where level control of pump station is provided using Variable Frequency Drives (VFD's,) provide minimum Amperes per Mode Suppression of 150,000.
 - i. Comply with MIL Standard 220A Method of Insertion Loss Measurement

- j. NFPA-70 (NEC), National Electrical Code – Surge Protective Device Installation Practice and Grounding
 - k. ANSI/IEEE C62.41 and C62.45,
 - l. UL 67 and UL 891
 - m. Provide optional NEMA 4X enclosure and internal fusing/overload protection. Plastic NEMA 4X enclosures are acceptable for Surge Protection Devices in lieu of Stainless Steel.
- 2. Warranty: Minimum 10-year unlimited module replacement.
 - 3. Approved products: (See Appendix D "List of Approved Products")

2.03 SERVICE ENTRANCE ACCESSORIES

- A. Wall and Floor Seals: Provide wall and floor seals complying with Section 16190 "Supporting Devices" in accordance with the following listing:
 - 1. Wall and Floor Seals

PART 3 - EXECUTION

3.01 INSTALLATION OF SERVICE ENTRANCE EQUIPMENT

- A. Install service entrance equipment as indicated, in accordance with equipment manufacturer's written instructions, and with recognized industry practices, to ensure that service entrance equipment fulfills requirements. Comply with applicable installation requirements of NFPA-70 and NEMA standards.
- B. Coordinate with other electrical work, including utility company wiring, as necessary to interface installation of service entrance equipment work with other work.

3.02 GROUNDING

- A. Provide equipment bonding and grounding connectors, sufficiently tight to assure a permanent and effective ground, for service entrance equipment and wiring/cablings as indicated.

3.03 SURGE PROTECTION DEVICE (SPD)

- A. Install Surge Protection Device so leads are maintained at minimum length and minimum number of bends.
- B. Install Surge Protection Device on the load side of the main disconnect using split bolt connectors.
- C. All Surge Protection Devices (SPD's) shall be UL approved or NRTL approved to UL standards, and installed per respective power company requirements and manufacturer's specifications.
- D. Surge Protection Device shall be attached to the load side of the station main disconnect and be mounted in a separate NEMA 4X enclosure.

3.04 ADJUST AND CLEAN

- A. Adjust operating mechanisms for free mechanical movement.
- B. Touch up scratched or marred enclosure surfaces to match original finishes.

3.05 FIELD QUALITY CONTROL

- A. Upon completion of installation of service entrance equipment and electrical circuitry, energize circuitry and demonstrate capability and compliance with requirements. Where possible, correct malfunctioning units at site, then retest to demonstrate compliance; otherwise, remove and replace with new units, and retest.

END OF SECTION

THIS PAGE LEFT BLANK INTENTIONALLY

SECTION 16450

GROUNDING

PART 1 - GENERAL

1.01 RELATED DOCUMENTS

- A. Drawings and general provisions of Contract, including General and Supplementary Conditions and Division 1 Specification sections, apply to work of this Section.

1.02 DESCRIPTION OF WORK

- A. Extent of grounding work is indicated by drawings and schedules. This Section specifies the system for grounding electrical distribution and utilization equipment cabinets, motor frames, manholes, instrumentation, metal surfaces of process/mechanical equipment that contain energized electrical components, metal structures and buildings, outdoor metal enclosures, fences and gates. This Section also includes grounding of electrical systems and equipment and basic requirements for grounding for protection of life, equipment, circuits, and systems. Grounding requirements specified in this Section may be supplemented in other Sections of these Specifications.
- B. Work described in this Section includes furnishing all labor, materials, equipment, tools and incidentals required for a complete installation of grounding system. All work shall be installed, adjusted and tested in accordance with these Specifications, the manufacturer's recommendations and as shown on the Drawings. Types of grounding specified in this Section include the following:
 - 1. Solid Grounding
- C. Applications of grounding work in this Section include the following:
 - 1. Underground metal water piping
 - 2. Grounding electrodes
 - 3. Grounding rods
 - 4. Service equipment
 - 5. Enclosures
 - 6. Equipment
 - 7. Fences and gates

1.03 QUALITY ASSURANCE

- A. Manufacturers: Firms shall have sufficient experience in the manufacture of electrical connectors, terminals and fittings, of types and ratings required, and ancillary grounding materials, including stranded cables, copper braid and bus, ground rods and plate electrodes, for manufacture of grounding equipment for use in this Project.

- B. Installer: Firms shall have sufficient experience to allow for quality and successful installation of grounding equipment for this Project.
- C. NFPA-70 Compliance: Comply with NFPA-70 requirements as applicable to materials and installation of electrical grounding systems, associated equipment and wiring. Provide grounding products which are UL listed and labeled.
- D. UL Compliance: Comply with applicable requirements of UL Standards Numbers 467 and 869 pertaining to electrical grounding and bonding.
- E. IEEE Compliance: Comply with applicable requirements of IEEE Standard 81, 142 and 241 pertaining to electrical grounding.
- F. NETA Compliance: Comply with the International Electrical Testing Association, Inc. Acceptance Testing Specifications.
- G. Testing Agency Qualifications: A "Nationally Recognized Testing Laboratory" (NRTL) as defined in OSHA Regulation 1910.7, or a full member company of the international Electrical Testing Association (NETA).
 - 1. Testing Agency Field Supervision: Use persons currently certified by NETA or the National Institute for Certification in Engineering Technologies to supervise on-site testing specified in Part 3.
- H. Comply with NFPA 70.
- I. Comply with UL 467.
- J. Listing and Labeling: Provide products specified in this Section that are listed and labeled.
 - 1. The Terms "Listed" and "Labeled." As defined in the National Electrical Code, Article 100.
 - 2. Listing and Labeling Agency Qualifications: A "Nationally Recognized Testing Laboratory" (NRTL) as defined in OSHA Regulation 1910.7.
- K. See also Section 16010 Part 1 for listing of applicable reference standards.

1.04 SHOP DRAWINGS AND SUBMITTALS

- A. Submittals shall be submitted to the County/Professional for review and acceptance prior to construction in accordance with the General Conditions and specifications Section 01300 "Submittals."
- B. Product Data: Submit manufacturer's data on grounding systems and accessories.
- C. A copy of this specification section with addendum updates included, and all referenced and applicable sections with addendum updates included, with each paragraph check-marked to indicate specification compliance or marked to indicate requested deviations from specification requirements. Check marks shall denote full compliance with a paragraph as a whole.

- D. If deviations from the specifications are indicated, and therefore requested by the Contractor, each deviation shall be underlined and denoted by a number in the margin to the right of the identified paragraph, referenced to a detailed written explanation of the reasons for requesting the deviation.
- E. The County shall be the final authority for determining acceptability of requested deviations. The remaining portions of the paragraph not underlined will signify compliance on the part of the Contractor with the specifications.
- F. Failure to include a copy of the marked-up specification sections along with justification(s) for any requested deviations to the specification requirements, with the submittal shall be sufficient cause for rejection of the entire submittal with no further consideration.

PART 2 - PRODUCTS

2.01 GENERAL

- A. All material supplied shall be one of the products specified in Appendix D "List of Approved Products" appended to these technical specifications.

2.02 ACCEPTABLE MANUFACTURERS

- A. Manufacturers: Subject to compliance with requirements, provide grounding products of one of the following:
 1. Apache Grounding; Nashville Wire Products
 2. Chance: A. B. Chance Co.
 3. B-Line Systems, Inc.
 4. Burndy Corp.
 5. Crouse-Hinds Co.
 6. Electrical Components Div.; Grould, Inc.
 7. Galvan Industries, Inc.
 8. General Electric Supply Co.
 9. Hastings Fiber Glass Products, Inc.
 10. Heary Brothers Lightning Protection Co.
 11. Kearney
 12. Ideal Industries, Inc.
 13. Lightning Master Corp.
 14. Lyncole XIT Grounding.
 15. O-Z/Gedney Co.
 16. Raco, Inc.
 17. Thomas and Betts Corp.

2.03 GROUNDING SYSTEMS

A. Materials and Components

1. General: Except as otherwise indicated, provide electrical grounding systems indicated; with assembly of materials, including, but not limited to, cables/wires, connectors, terminals (solderless lugs), grounding rods/electrodes, and plate electrodes, bonding jumper braid, surge arrestors, and additional accessories needed for complete installation. Where more than one type unit meets indicated requirements, selection is Installer's option. Where materials or components are not indicated, provide products complying with NFPA-70, UL, IEEE, and established industry standards for applications indicated.
2. Governing Requirements: Where types, sizes, ratings, and quantities indicated are in excess of National Electrical Code (NEC) requirements, the more stringent requirement and the greater size, rating, and quantity indications shown shall be adhered.
3. A counterpoise cable grounding system installed a minimum of 30-inches below grade, shall be installed with connections to at least the following equipment:
 - a. Wetwell cover
 - b. Valve vault cover
 - c. Control panels
 - d. Generator
 - e. Electrical system grounding electrode conductor
 - f. Main disconnect switch
 - g. Fence
 - h. Emergency bypass piping and station back flow preventer and water spigot to be bonded
 - i. Exception: Ground connection to fencing is not required for PVC coated chain link fence framing, concrete block wall, or wood fencing.
4. Provide raceways, and electrical boxes and fittings complying with accordance with the following listing:
 - a. PVC conduit
 - b. PVC conduit fittings
 - c. Liquid-tight flexible metal conduit
 - d. Liquid-tight flexible metal conduit fittings
 - e. Rigid aluminum conduit
 - f. Rigid aluminum conduit fittings

B. Conductors: Unless otherwise indicated, provide electrical grounding conductors for grounding connections matching power supply wiring materials and sized according to NFPA-70.

C. Ground Rods: Steel with copper welded exterior, 3/4-inch dia. x 10-feet.

D. Electrical Grounding Connection Accessories: Provide electrical insulating tape, heat-shrinkable insulating tubing, welding materials, bonding straps, as recommended by accessories manufacturers for type services indicated.

E. Comply with Division 16 Section 16120 "Wires and Cables." Conform the NEC Table 8, except as otherwise indicated, for conductor properties, including stranding.

- F. Equipment Grounding Conductors: Insulated copper with green color insulation.
- G. Grounding-Electrode Conductors: Stranded copper cable.
- H. Underground Conductors: Bare and stranded copper.
- I. Bare Copper Conductors: Conform to the following:
 - 1. Solid Conductors: ASTM B3
 - 2. Assembly of Stranded conductors: ASTM B8
- J. Ground cable shall be soft-drawn, bare annealed copper, concentric stranded, as specified.
- K. The minimum sizes shall be as follows, where American Wire Gauge (AWG) cable sizes are not shown or specified:

5 and 15 kV switchgear	2/0 or 4/0 AWG
5 kV motor starters	2/0 or 4/0 AWG
15 kV-5 kV transformers	2/0 or 4/0 AWG
5 kV-480V transformers	2/0 or 4/0 AWG
480V switchgear	2/0 or 4/0 AWG
480V switchboards	2/0 or 4/0 AWG
480V MCC and	2/0 or 4/0 AWG
Cable tray	2/0 or 4/0 AWG
Large motors 250 hp & >	2/0 or 4/0 AWG
Lighting & Power panels	2 AWG
Exposed metal cabinets	2 AWG
Electrical equipment	2 AWG
Buildings and enclosure	2 AWG
Fences and gates	2 AWG
Motors 25 hp to 250 hp	2 AWG
Motors 1 hp to 25 hp	6 AWG
- L. Grounding Bus: Bare, annealed copper bars of rectangular cross section.
- M. Braided Bonding Jumpers: Copper tape, braided Number 3/0 AWG bare copper wire, terminated with copper ferrules.
- N. Bonding straps: Soft copper, 0.05-inch (1-mm) thick and 2-inches (50-mm) wide, except as indicated.
- O. Compression connections shall be irreversible, cast copper, high conductivity as manufactured by Thomas and Betts, or equal.
- P. Bolted connectors shall be Burndy, O. Z. Gedney, or equal heavy-duty type.

- Q. Exothermic welding products shall be Erico's Cadweld Plus system with electronic ignition device and moisture resistant weld metal cup for the required mold, or equal. Connectors shall be provided in kit form and selected per manufacturer's written instructions for specific types, sizes, and combination of conductors and connected items.
- R. Provide concrete test well with cover and connect the ground grid extension using a removable connector.
- S. Copper equipment ground bars shall be Erico Eritech EGB Series or equal, sized as required for the installation.

PART 3 - EXECUTION

3.01 APPLICATION AND TESTING

- A. Contractor shall test ground rod to obtain a ground resistance value of less than 5 ohms.
- B. Maximum distance between counterpoise ground rods shall be 100-feet. Provide additional ground rods as required.
- C. Counterpoise shall be installed a minimum of 30-inches below grade.
- D. Tests: Before making connections to the ground electrode, measure the resistance of the electrode to ground using a ground resistance tester specifically designed for ground resistance testing. Perform the test not less than 2-days after the most recent rainfall, and in the afternoon after any ground condensation (dew) has evaporated. If a resistance less than the performance requirements is not obtained, provide a ground rod driven 6-inches below grade spaced 10-feet away from the ground well and connect to ground test well with Number 2/0 tinned stranded copper wire and repeat the test. If the performance requirements are still not obtained, inform the County for resolution. Testing results by a certified testing agency using fall of potential testing as described by NETA (International Electrical Testing Association).
- E. Provide a certified copy of the grounding test report to the County.
- F. Equipment grounding Conductors: Comply with NEC Article 250 for types, sizes, and quantities of equipment grounding conductors, except where specific types, larger sizes, or more conductors than required by NEC are indicated.
 - 1. Install equipment grounding conductor with circuit conductors for the items below in addition to those required by Code:
 - a. Feeders and branch circuits
 - b. Lighting circuits
 - c. Receptacle circuits
 - d. Single-phase motor or appliance branch circuits
 - e. Three-phase motor or appliance branch circuits
 - f. Flexible raceway runs

2. Metallic Raceways: Raceways, conduits and cable trays, etc. shall be made electrically continuous, and shall be bonded/grounded to earth. Utilize bonding/grounding wires, jumpers, clamps, etc. as necessary to meet requirements of NEC.
 3. Non-metallic Raceways: Install a grounding conductor in non-metallic raceways unless they are designated for telephone or data cables.
 4. Air-Duct Equipment Circuits: Install a grounding conductor to duct mounted electrical devices operating at 120 V and above, including air cleaners and heaters. Bond conductor to each unit and to air duct.
 5. Water Heater, Heat-Tracing, and Anti-frost Heater Circuits: Install a separate grounding conductor to each electric water heater, heat-tracing assembly, and anti-frost heating cable. Bond conductor to heater units, piping, connected equipment, and components.
- G. Signal and Communication Systems: For telephone, alarm, voice and data, and other communication systems, provide a Number 4 AWG minimum insulated grounding conductor from grounding-electrode system to each service location, backboard, terminal cabinet, wiring closet, and central equipment location.
1. Service and Central equipment Locations and wiring Closets: Terminate grounding conductor on a 1/4 by 2 by 12-inch (6 by 50 by 300-mm) grounding.
 2. Terminal Cabinets: Terminate grounding conductor on cabinet grounding terminal.
- H. Separately Derived Systems: Where NEC requires grounding, ground according to NEC.
- I. Metal Poles Supporting Lighting Fixtures: Ground pole to a grounding electrode in addition to separate equipment grounding conductor run with supply branch circuit.
- J. General: Ground electrical systems and equipment according to NEC requirements, except where Drawings or Specifications exceed NEC requirements.
- K. Grounding Electrode System: Where available on the premises, at each building or structure served, a metal underground water pipe, the metal frame of the building or structure, concrete encased electrodes, any ground ring encircling the building or structure and all made electrodes (ground rods, etc.) shall be bonded together to form the grounding electrode system. The main bonding jumper and the grounding electrode conductor shall be installed and sized per NEC except where larger sizes than required by NEC are indicated.
- L. Grounding Rods: A minimum of two (2) ground rods shall be installed where the ground rod serves as the grounding electrode per NEC. Locate a minimum of 1-rod length from each other and at least the same distance from any other grounding electrode.
1. Drive until tops are 2-inches (50-mm) below finished floor or final grade, except as otherwise indicated.
 2. Interconnect with grounding-electrode conductors except at test wells and as otherwise indicated. Use exothermic welds or irreversible compression connections. Make these connections without damaging copper coating or exposing steel.
- M. Grounding Conductors: Route along the shortest and straightest paths possible, except as otherwise indicated. Avoid obstructing access or placing conductors where they may be subjected to strain, impact, or damage.

- N. Grounding conductors, insulated and color coded green, shall be provided in all low voltage feeder and sub-feeder and branch circuit conduit runs, except low voltage service entrance conduit runs which contain a grounded neutral. These grounding conductors shall be connected to all metallic conduits by means of approved grounding bushings at all conduit terminations at the supply end of all feeders.
- O. General: Make connections so possibility of galvanic action or electrolysis is minimized. Select connectors, connection hardware, conductors, and connection methods so metals in direct contact will be galvanically compatible.
1. Use electroplated or tin-coated materials to assure high conductivity and to make contact points closer in order of galvanic series.
 2. Make connections with clean, bare metal at points of contact.
 3. Make aluminum-to-steel connections with stainless steel separators and mechanical clamps.
 4. Make aluminum-to-galvanized steel with tin-plated copper jumpers and mechanical clamps.
 5. Coat and seal connections having dissimilar metals with inert material to prevent future penetration of moisture to contact surfaces.
- P. Exothermic-Welded Connections: Use for connections to structural steel and for underground connections, except those at test wells. Comply with manufacturer written instructions. Welds that are puffed up or that show convex surfaces indicating improper cleaning are not acceptable. Irreversible compression connections may be acceptable as an alternate method.
- Q. Equipment Grounding-Wire Terminations: For Number 8 AWG and larger, use pressure-type grounding lugs. Number 10 AWG and smaller grounding conductors may be terminated with winged pressure-type connectors.
- R. Non-contact metal Raceway Terminations: Where metallic raceways terminate at metal housings without mechanical and electrical connection to housing, terminate each conduit with a grounding bushing. Connect grounding bushings with a bare grounding conductor to grounding bus or terminal in housing. Bond electrically non-continuous conduits at both entrances and exits with the grounding conductors, except as otherwise indicated.
- S. Connections at Test Wells: Use compression-type connectors on conductors and make bolted and clamped-type connections between conductors and grounding rods.
- T. Tighten screws and bolts for grounding and bonding connectors and terminals according to manufacturer's published torque-tightening values. Where these requirements are not available, use those specified in UL 486A and UL 486B.
- U. Compression-Type Connections: Use hydraulic compression tools to provide correct circumferential pressure for compression connectors. Use tools and dies recommended by manufacturer of connectors. Provide embossing die code or other standard method to make a visible indication that a connector has been adequately compressed on grounding conductor.

END OF SECTION

APPENDIX A

GEOTECHNICAL REPORT

The attached Geotechnical Engineering Investigation and dewatering ground water sampling was accomplished for the utilization of the Design Engineer during the design phases of this project. The criteria and recommendations stated herein are not to be construed as direction from the Design Engineer to the Contractor and are hereby provided only as general information, furnished as a courtesy to the Contractor.

**GEOTECHNICAL INVESTIGATION REPORT
ORANGE COUNTY UTILITIES PACKAGE 1
PUMP STATION REHABILITATION
PUMP STATION 3309 and PUMP STATION 3365
ORANGE COUNTY, FLORIDA**

AEA PROJECT No. 201112-4

Antillian Engineering Associates, Inc.
3331 Bartlett Boulevard
Orlando, Florida 32811
(407) 422-1441



November 19, 2012

BFA Environmental, Inc.
1230 East Hillcrest Street
Orlando, Florida 32803

Attention: Geoff Hennessy, P.E.

Reference: Geotechnical Investigation Report
Orange County Utilities Package 1
Pump Station Rehabilitation
Pump Station 3309 and Pump Station 3365
Orange County, Florida
AEA Project No. 201112-4

Dear Mr. Hennessy:

Antillian Engineering Associates, Inc. has completed the geotechnical engineering investigation for the proposed rehabilitations of Pump Station 3309 and Pump Station 3365 in eastern Orange County, Florida. The work on this project was authorized under Orange County Utilities Continuing Utilities Engineering Contract Y11-902A. It was done in general accordance with the scope of services presented in our proposal dated March 28, 2012. This report contains the results of our investigations, our recommendations for pump station design and construction, earthwork, groundwater control and other concerns as appropriate.

It has been our pleasure to serve BFA Environmental, Inc. and Orange County Utilities on this project. Please do not hesitate to call if you have any questions or if you need additional information.

Very truly yours,

ANTILLIAN ENGINEERING ASSOCIATES, INC.

State of Florida Authorization No. EPO008

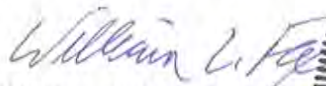
William L. Fox, P.E.
Geotechnical Engineer
Florida Registration No. 55385

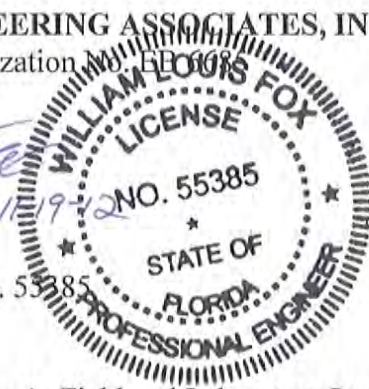

Peter G. Suah, P.E.
Principal Engineer
Florida Registration No. 46910



Attachments: Figures
Appendix A: Field and Laboratory Investigations
Appendix B: Important Information About Your Geotechnical Engineering Report
Appendix C: Constraints and Restrictions

PROJECT DESCRIPTION

Orange County Utilities (OCU) is planning to rehabilitate two pump station sites in the eastern part of the county. Pump Station 3309 is situated on the southern side of Lena Street about 100 feet west of Percival Road. Pump Station 3365 is situated on the southern side of University Boulevard about 800 feet west of Rouse Road. The approximate locations of the pump station sites are shown on Figure 1. Although these two pump stations are more than three miles apart, OCU has combined them into a single package for design and construction.

Improvements at Pump Station 3309 (“PS 3309”) will include the demolition and removal of the existing concrete valve vault and replacement with a new precast concrete vault. The new structure will be installed at the same location as the existing structure and will be slightly larger in plan. It is expected to bear about five feet below grade near the same level as the existing vault. An existing valve vault at Pump Station 3365 (“PS 3365”) will also be demolished and removed but will not be replaced. New yard piping and replacement electrical panels are also planned for both sites.

It is our understanding that the existing wet wells at each site will be rehabilitated in lieu of replacement. Site grades are not expected to change.

AVAILABLE INFORMATION

The United States Geological Survey (USGS) quadrangle topographic map that covers both areas was reviewed to obtain general information about the project area. The USGS map showed the project vicinity surrounding PS 3309 as a level area located to the north and west of a low-lying area. Land usage was mapped as suburban and residential. Some of the existing streets in the vicinity were shown on the map. Ground surface elevations were mapped near the Elevation 55 feet NGVD (El. 55) contour. The project vicinity surrounding PS 3365 was shown as a level, comparatively low-lying area. Land usage was mapped as suburban to urban and like PS 3309, most of the existing streets in the vicinity were shown. Ground surface elevations were mapped near the El. 50 contour.

[END OF SECTION]

FIELD INVESTIGATION

A site reconnaissance was conducted at each pump station to prepare for the drilling program. Test boring locations were established in the field at locations accessible to the drill rig and were staked for underground utility location and marking as required by Florida Statutes.

A single test boring was drilled at each site on October 12, 2012. Boring B-3309 was drilled at PS 3309 and Boring B-3365 was drilled at PS 3365. Approximate locations are shown on Figure 2. Both borings were advanced to a depth of 30 feet by mud-rotary drilling. The Standard Penetration Test (SPT) with split-spoon sampling was conducted in accordance with ASTM D 1586. Sampler penetration resistance, expressed in hammer blows per foot (the "SPT N-value"), was used as an empirical indication of soil consistency.

The soils encountered during drilling were logged by the field crew. Representative samples were sealed in clean, airtight containers for transportation to our Orlando office. The stabilized depth to groundwater encountered in each boring was measured and recorded on the field logs. At the completion of the drilling program, the boreholes were backfilled to the ground surface with soil cuttings mixed with sand and bentonite chips.

LABORATORY TESTING

The recovered soil samples were examined in our office by a geotechnical engineer who confirmed the descriptions on the field logs, classified the soils visually and developed a representation of the soil stratigraphy at each boring location. Representative soil samples were selected for laboratory testing, which consisted of seven single-sieve gradation analyses, one organic content test, two natural moisture content tests and one series of Atterberg limits tests. The test results are presented on the boring logs and on the Summary of Laboratory Test Results sheet in Appendix A.

[END OF SECTION]

SURFACE CONDITIONS

Both sites were existing wastewater pump stations enclosed by locked chain-link fences. The ground surface at both sites was nearly level to level. The area within the fence at PS 3309 was covered with grass turf while PS 3365 was mostly paved with asphalt and concrete. Valve vaults, wet wells, electrical panels and piping were observed.

Both sites were adjacent to developed, single-family residential areas. Wet stormwater detention ponds were located adjacent to each site. The water surface was estimated to be about 12 feet below the ground surface in the pond at the PS 3309 site, while the water surface in the pond at the PS 3365 site was about four feet below the surrounding banks. Water depth could not be ascertained in either pond.

SUBSURFACE CONDITIONS

Pump Station 3309 (Boring B-3309)

The uppermost material in B-3309 was brown fine sand that appeared to contain small amounts of silt mixed with gravel and clayey sands. Its encountered thickness was about six feet. SPT N-values ranged from 7 blows per foot (bpf) to 13 bpf, indicating that the soils were loose to medium dense. Based on the observed variability in composition, consistency and color, these soils were classified visually as “possible fill”.

Beneath the possible fill was dark brownish gray fine sand that appeared to contain some silt. Its encountered thickness was about six feet. SPT N-values ranged from Weight of Hammer (“WOH”) to 8 bpf, indicating that the soils were very loose to loose. The SPT N-values were highest at the top of the layer and decreased with depth. Single-sieve gradation analysis of one sample indicated a fines content (fraction by dry weight passing the U.S. Standard No. 200 sieve size) of 12 percent which resulted in the Unified Soil Classification System (USCS) designation “SM” for silty sand.

Beneath the silty sand was gray fine sand that appeared to contain some clay. This soil exhibited a slightly plastic texture. Its encountered thickness was about two feet. The single SPT N-value recorded in this soil was 4 bpf, indicating that the soils were loose. Single-sieve gradation analysis of one sample indicated a fines content of 22 percent and resulted in the USCS designation “SC” for clayey sand.

Beneath the clayey sand was very light gray fine sand that appeared to contain a trace of silt. Its encountered thickness was about three feet. The single SPT N-value recorded in this soil was 11 bpf, indicating that the soils were medium dense. Visual classification of the sample resulted in the USCS designation “SP” for fine sand.

Beneath the fine sand was gray sand that appeared to contain clay. Its encountered thickness was about eight feet. SPT N-values were 10 bpf and 13 bpf, indicating that the soils were loose to medium dense. Single-sieve gradation analyses of two samples indicated fines contents of 15

percent and 38 percent. Additional testing on the sample with the higher fines content indicated natural moisture content of 34 percent, liquid limit of 27 and plasticity index of 9. The tests resulted in the USCS designation “SC”.

Beneath the clayey sand was grayish brown sand that appeared to contain some silt. Its encountered thickness was about six feet. Its actual thickness could not be confirmed because the boring was terminated in this material without penetrating it completely. The single SPT N-value was 18 bpf, indicating that the soils were medium dense. Visual classification of the sample resulted in the USCS designation “SP-SM” for sand with silt.

Groundwater was encountered in the borehole at B-3309 at a depth of about 12 feet below the existing ground surface. Details of the encountered subsurface characteristics are shown on the boring log and on the Summary of Laboratory Tests sheet in Appendix A.

Pump Station 3365 (Boring B-3365)

Pavement consisting of approximately three inches of asphalt on 15 inches of compacted, crushed limestone (“limerock”) base was encountered uppermost in boring B-3365. Beneath the pavement was brown, grayish brown, and dark brown fine sand that appeared to contain small amounts of silt. The encountered thickness of this material was about 12 feet. SPT N-values ranged from 11 bpf to 20 bpf, indicating that the soils were medium dense. Single-sieve gradation analyses of two samples indicated fines contents of 4 percent and 6 percent, which resulted in the USCS designations “SP” for fine sand and “SP-SM” for sand with silt.

Beneath the sand was dark brown fine sand that appeared to contain more silt and some organic material. Its encountered thickness was about five feet. The single SPT N-value recorded in this layer was 4 bpf, indicating that the soils were loose. Single-sieve gradation analysis of one sample indicated a fines content of 25 percent. Additional testing indicated a natural moisture content of 39 percent and organic content of 20 percent. The tests resulted in the USCS designation “SM” for silty sand with organic fines.

Beneath the silty fine sand with organic fines was dark grayish brown fine sand that appeared to contain less silt. Its encountered thickness was about 13 feet. The actual thickness could not be confirmed because the boring was terminated in this material without penetrating it completely. Trace to some wood and roots were observed in the samples obtained at 20 feet and 25 feet. SPT N-values ranged from 20 bpf to 32 bpf, indicating that the soils were medium dense to dense. Samples were classified visually and given the USCS designation “SP-SM”.

Groundwater was encountered in the borehole at B-3365 at a depth of about four feet below the existing ground surface. Details of the encountered subsurface characteristics are shown on the boring log and on the Summary of Laboratory Tests sheet in Appendix A.

GENERAL COMMENTS ON RECOMMENDATIONS

The following recommendations are based upon a review of the field and laboratory test data, our understanding of the proposed construction and our experience with similar projects and subsurface conditions. If plans for the proposed construction change from those discussed in this report, we request the opportunity to review our recommendations, and amend them as needed to accommodate those changes. In addition, if subsurface conditions encountered during construction differ significantly from those encountered in the borings, those conditions should be reported to us immediately for our observation and recommendations.

GENERAL ASSESSMENT OF ENCOUNTERED SOILS

As discussed in the SUBSURFACE CONDITIONS section of this report, the soils encountered during this investigation were mostly fine sands containing varying amounts of silt and clay. At PS 3309, loose to medium dense sandy soils occasionally containing gravel and clayey sands were encountered from the ground surface to a depth of about six feet. Loose to very loose sands were encountered beneath the fill to a depth of about 14 feet. At PS 3365, the asphalt pavement was underlain by medium dense sand to a depth of about 12 feet, followed by very loose, dark brown silty fine sand with organic fines to a depth of about 17 feet. Buried trash, debris or other objectionable materials were not encountered in the borings.

Generally speaking, the soil conditions discussed above should not significantly affect the proposed pump station improvements. The encountered soils at PS 3309 are suitable for supporting the proposed valve vault. Since that vault is expected to be similar in size and bearing depth to the existing vault, little to no additional loading and additional stress increase on underlying soils is anticipated. Therefore, total and differential settlements of the proposed structure beyond tolerable limits are not anticipated.

As discussed earlier, proposed improvements to PS 3365 include the demolition and removal of the existing below-grade concrete vault structure located near the northeast corner of the site adjacent to University Boulevard. The bottom of this existing structure is about eight feet below grade so the loose, silty sand with organic fines is not likely to be encountered during its removal. Further, we understand that the other proposed improvements do not include excavation to depths that would encounter the loose silty fine sand with organic fines, as encountered at B-3365, nor any new structures. No new loads on the soils are expected.

VALVE VAULT DESIGN

The increase in vertical pressure induced in the soil beneath an embedded structure by the total weight on its foundation (the “contact pressure” or “gross bearing pressure”) is reduced by the soil pressure that existed at the bearing level prior to foundation excavation (the “overburden” pressure). The gross bearing pressure induces structural stresses within the foundation itself while the difference between the gross bearing pressure and overburden pressure (i.e, the “net bearing

pressure”) induces stress in the bearing soils. A completely buried structure like a valve vault (even with additional mass to resist uplift and when full of water with all equipment installed) typically does not weigh more than the soil that was removed for its installation. As a result, the net bearing pressure tends to be low. Since settlement is caused by an increase in net bearing pressure, little to no settlement is expected beneath the valve vault.

The bottom of the proposed valve vault will function as a structural mat foundation. The gross bearing pressure calculated by the designer should be used for structural design purposes because it is derived from the actual dimensions and characteristics of the structure. For preliminary structural design of the mat foundation, we suggest using a gross bearing pressure of 500 psf for a typical five-foot-deep structure until the actual gross bearing pressure is calculated.

The valve vault should be designed to ensure that there is no uplift when it is empty. Uplift resistance should be derived from the weight of the structure along with the weight of the backfill resting on any parts of the foundation that project horizontally beyond the side walls. Side friction resistance along the vertical face of the valve vault walls should not be considered. A groundwater level equal to the finished ground surface should be used to determine uplift resistance.

As discussed earlier in this report, the new valve vault is expected to bear at a depth of about five feet. For design of the valve vault walls, the groundwater should be assumed to be level with the finished ground surface. Under those conditions, we recommend using a saturated soil unit weight of 120 pounds per cubic foot (pcf) and a lateral earth pressure coefficient of 0.5. That coefficient represents the “at-rest” condition because small, enclosed structures tend to be self-bracing and unlikely to deform to the extent needed for the soil to attain the active condition. The same lateral earth pressure coefficient should be applied to surface loads around the valve vault, including nearby shallow foundations and incidental vehicular traffic. In the absence of specific load information, vehicular traffic should be represented by a uniformly distributed vertical load of 250 pounds per square foot (psf). If the groundwater level is assumed to be at the ground surface, the lateral earth pressure induced by the soil only may be represented by an equivalent fluid pressure of 29 pcf for structural design purposes only, to which the hydrostatic pressure must be added.

EARTHWORK FOR BELOW-GRADE CONSTRUCTION

Valve Vault and Pipe Installation

In order to remove the existing concrete vault structure at each site a temporary excavation support system will be needed to withstand the anticipated lateral loads and limit unacceptable movement of the surrounding soils and adjacent structures. Excavation support will also be needed when the new vault and piping are installed. This approach will likely require dewatering of the excavation in order to establish and maintain a dry, stable and safe work area. All below-grade activity should be conducted in accordance with the recommendations for excavation safety and groundwater control presented later in this report.

Careful attention must be paid to the selection, installation, operation, monitoring, maintenance and removal of the temporary excavation support system. It should provide sufficient working room for

typical below-grade activities such as installation of formwork and backfill compaction. As it is being removed, the temporary excavation support system should not disturb the completed structure nor the backfill and adjacent structures. The contractor should prepare contingency plans so that the cause(s) of any observed distress to the excavation support system, surrounding soils, or adjacent structures can be identified promptly and accurately, and addressed decisively.

Conventional construction equipment should be able to dig the excavations. However, since the proposed work areas extended beyond the test boring locations into other areas that were not explored, roots, organic materials, debris, medium dense to dense soils and cemented soils are possible and should be expected, even though such materials were not encountered in the borings. The excavations should be dug to the depths and widths needed for proper removal of the existing structures and installation of the valve vault, the excavation support system, and any below-grade equipment or materials that may be needed. This work should be supervised by a suitably qualified member of the contractor's staff, who should ensure that the excavation is not being over-dug unnecessarily and that the bearing soils are not being disturbed. The supervisor should check for zones of especially loose or soft soils that were not encountered in the test borings. All soft, loose or muddy materials should be carefully and completely removed to expose uniform, undisturbed soil.

Concrete foundations need uniform support to function effectively, even when lightly loaded. As a result, cleared bearing surfaces should be examined and probed by a geotechnical engineer or a suitably qualified representative to locate unusually soft or yielding areas, hard spots or other non-uniform conditions. Non-uniform conditions should be treated as directed by the Engineer and the County in consultation with the examining geotechnical engineer.

Exposed subgrade soils at the bottom of excavations made to install the valve vault and pipes should be thoroughly and uniformly compacted to achieve not less than 95 percent of the maximum dry density obtained by the Modified Proctor method (ASTM D 1557) to a depth at least one foot below subgrade level. Because of the sandy nature of the soils, this work should be done just before foundation concrete is placed to reduce the risk of disturbance. Immediately after the overburden soils have been excavated, a thin layer of non-structural concrete (a "mud mat") may be placed on the exposed subgrade soils at the bottom of the valve vault excavation to protect the bearing soils from disturbance and to provide a stable, durable working surface for the remainder of the construction activity. In lieu of this compaction requirement, exposed subgrade soils at the bottom of the excavation made for the removal of the existing concrete vault at the PS 3365 site should be tamped to a firm and unyielding condition prior to placing backfill.

Backfill should be placed uniformly on all sides of the proposed valve vault and pipes in loose lifts approximately 8 inches thick before initiating compaction. Each lift should be compacted to not less than 95 percent of the maximum dry density obtained by the Modified Proctor method (ASTM D 1557). Similarly, backfill should be placed uniformly within the excavation at the PS 3365 site in loose lifts approximately 8 inches thick before initiating compaction. Each lift should be compacted to not less than 92 percent of the maximum dry density obtained by the Modified Proctor method (ASTM D 1557). Backfill should be tested at a frequency not less than one test per vertical foot of backfill. The contractor should be prepared to change equipment, procedures and lift thickness as

needed (at no additional cost to the Owner) in order to achieve the recommended compaction. Additional recommendations for material reuse are discussed in the following section.

Backfill soils should consist of sand or other inert mineral material with a fines content not more than 12 percent. Backfill soils should be free from mud, muck and other organic materials, debris, rubbish or other materials that might decompose or otherwise cause excessive settlement. Most of the soil to be excavated for the valve vault should satisfy that condition, although some may be too wet or too dry for immediate reuse. General recommendations for material reuse are discussed in the following section.

REUSE OF EXCAVATED MATERIALS

Whenever possible, contractors reuse excavated soils as backfill. As discussed earlier in this report, the encountered soils varied in composition, which is natural and should be expected. As a result, the soil types that may be encountered during excavation on this project may vary. Possible soils are discussed below for general guidance. These guidelines should not be used to override the project specifications.

Poorly Graded Sands (SP)

These soils had fines contents of 5 percent or less, and are commonly referred to as “clean” sands. They are highly desirable for use as fill and backfill in central Florida because they drain freely, which allows these soils to be placed and compacted readily, even if they have been excavated from below the groundwater level. Satisfactory levels of compaction can be achieved using a wide variety of compaction equipment and across a relatively broad range of moisture contents. Because of the relatively small size, sub-rounded shape and near-uniform distribution of the soil particles, some instability or “pumping” can be expected if efforts are made to compact these soils near saturation.

Sands with Silt (SP-SM)

These soils consisted of sands with fines contents between 5 percent and 12 percent. Although these soils do not drain as freely as SP materials, they are still quite suitable for use as fill and backfill. If excavated from below the groundwater surface, they may have to be stockpiled and allowed to drain (or spread to dry) before being placed as fill. Satisfactory compaction can be achieved using a variety of compaction equipment and across a moderate to wide range of moisture contents, but efforts should be made to maintain the moisture content during compaction below the optimum moisture content. As with the SP materials, some instability or “pumping” can be expected if efforts are made to compact these soils as they approach saturation.

Silty Sands (SM)

These soils consisted of sands with fines contents between 12 percent and 50 percent. They do not drain as well as SP-SM soils, and only with very close attention to moisture content and selection of compaction equipment can these soils be used successfully as fill or backfill. Excavated SM soils will likely have to be stockpiled to drain and/or possibly spread to dry before being used. Suitable compaction is generally achieved in these soils only across a narrow range of moisture contents, and

this range narrows even further as the fines content increases. SM soils should be compacted below optimum moisture content to reduce the potential for moisture-related instability. Because of the additional complications associated with reusing these soils, we recommend disposing of soils with fines content higher than 20 percent and replacing them with SP, SP-SM or SP-SC materials.

GROUNDWATER CONTROL

During the rainy season in Florida (normally between June and September), groundwater levels are generally higher than those observed at other times of the year. The extent of the variation depends on several factors, including the terrain, the intensity and duration of rainfall, the hydrogeologic properties of the soils and the presence and proximity of artificial drainage facilities.

Based on our observations in the borings, the time of year of the investigation and a review of the Soil Survey of Orange County, it is our opinion that the seasonal high groundwater level should generally be at a depth below six feet at the location of B-1 (PS 3309), and at a depth within about two feet of the natural ground surface at the location of B-2 (PS 3365). The actual depth to groundwater at each site will be influenced by the depth to water in the adjacent stormwater ponds. Higher levels should be expected during unusually heavy or prolonged rainfall. For purposes of the design of below-grade structures, temporary excavation support systems, and dewatering systems, a groundwater level at the finished ground surface should be used. The encountered and estimated seasonal high groundwater levels are shown on the boring logs in Appendix A.

Groundwater should be expected to influence the proposed construction activity. All excavation and construction should be conducted in the dry. The contractor should be prepared to maintain the groundwater level at least two feet below the bottom of all work areas for the duration of below-grade construction activity. The contractor should be responsible for all aspects of dewatering, regardless of the groundwater level at the time of construction. That responsibility includes not just the installation and operation of an effective dewatering system, but also all permits needed to satisfy applicable environmental regulations, and all groundwater volume and quality monitoring systems. The contractor should also monitor the adjacent ground surface and equipment, and nearby buildings and other facilities for possible subsidence, cracking or other distress that may result from temporarily lowered groundwater levels.

To prevent any instability of the excavations, the groundwater should be drawn down before starting work. Water should be discharged as far as practically possible away from the work area to prevent return flow or erosion. The contractor should have submersible pumps ready to intercept and remove any localized inflows. Dewatering systems should not be decommissioned until below-grade structures are completely backfilled. The importance of proper groundwater control cannot be over-emphasized.

EXCAVATION SAFETY

The sides of all excavations more than four feet deep must be sloped or supported to withstand lateral forces exerted by the existing soils in accordance with the latest regulations promulgated by the Occupational Safety and Health Administration (OSHA). Any excavation support system must also be able to support possible hydrostatic pressures and surcharge loads. For calculating the lateral loads from the site soils on unbraced temporary excavation support systems, we recommend a soil unit weight of 125 pounds per cubic foot (pcf) and a lateral earth pressure coefficient of 0.4. This coefficient should be increased to 0.5 if the system is braced (the “at -rest” condition). The same coefficients should be applied to loads on the ground surface and from traffic (including construction equipment) around the excavations. Traffic loads should be represented by a uniformly distributed surcharge of 250 pounds per square foot (psf).

All excavations must be kept dry so that work can proceed safely and efficiently. As discussed in the GROUNDWATER CONTROL section, the groundwater level should be maintained at least two feet below the bottoms of all excavations. However, dewatering systems can fail, which would allow the groundwater to return to its pre-construction level and possibly fill the excavation. Pumping water out the excavations to resume work can temporarily reduce soil strength. This condition should be analyzed using the design high water level.

LIMITATIONS

This report presents an evaluation of the subsurface conditions on the basis of accepted geotechnical procedures for site characterization. The recovered soil samples were not examined or tested in any way for chemical composition or environmental hazards. The investigation was confined to the zone of soil which is likely to be affected by the proposed construction, and did not address the potential of surface expression of deep geologic activity such as sinkholes. This type of evaluation requires a more extensive range of services than those performed for this study.

Because of the natural limitations inherent in working with the subsurface, a geotechnical engineer cannot predict and address all possible problems. During construction, geotechnical issues not addressed in this report may arise. The bulletin “Important Information About Your Geotechnical Engineering Report” published by the Association of Engineering Firms Practicing in the Geosciences (ASFE) is presented in Appendix B to help explain the nature of geotechnical issues. Additional information is presented in Appendix C to discuss the potential concerns and the basic limitations of a typical geotechnical investigation report.

FIGURES

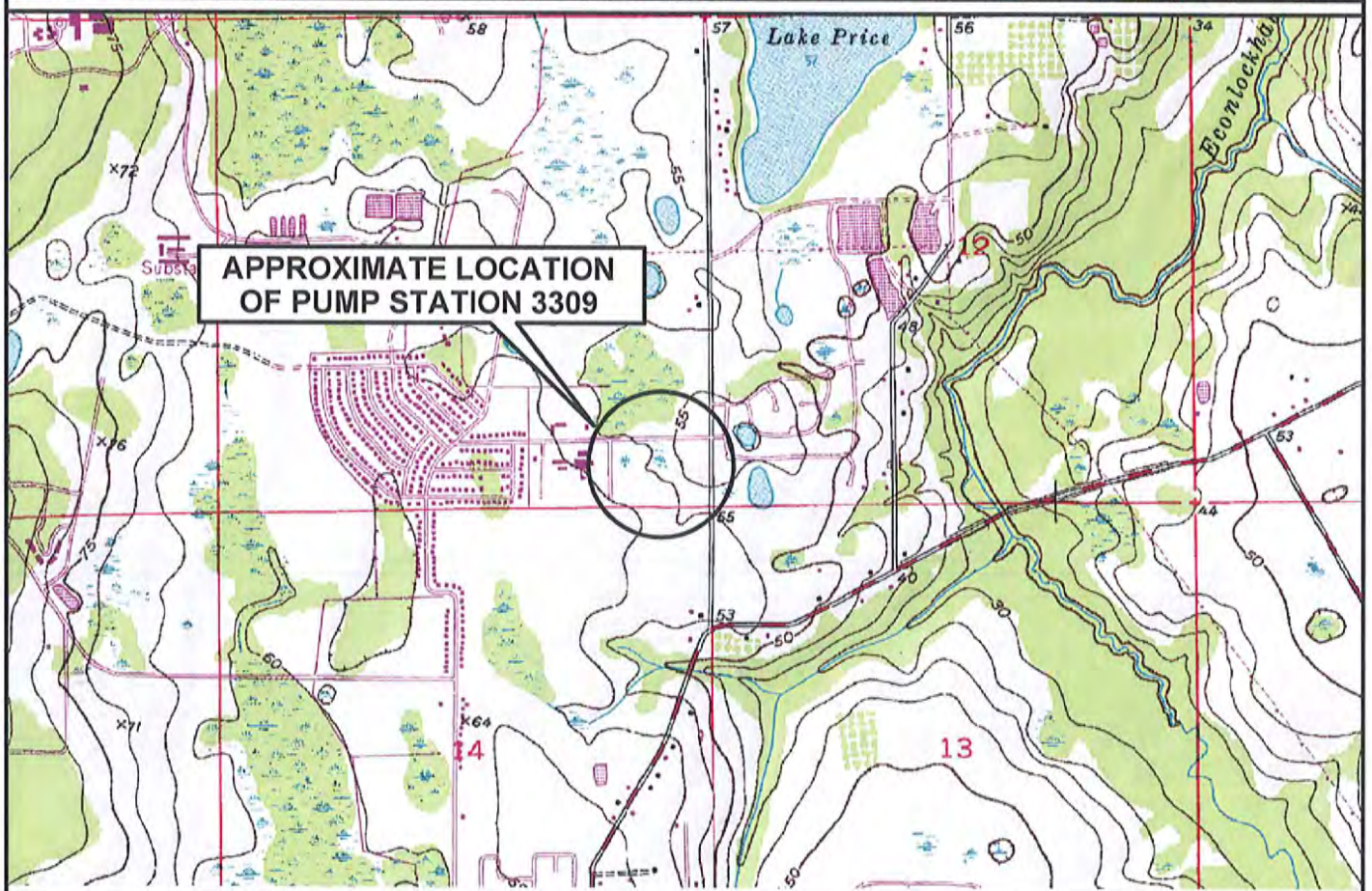
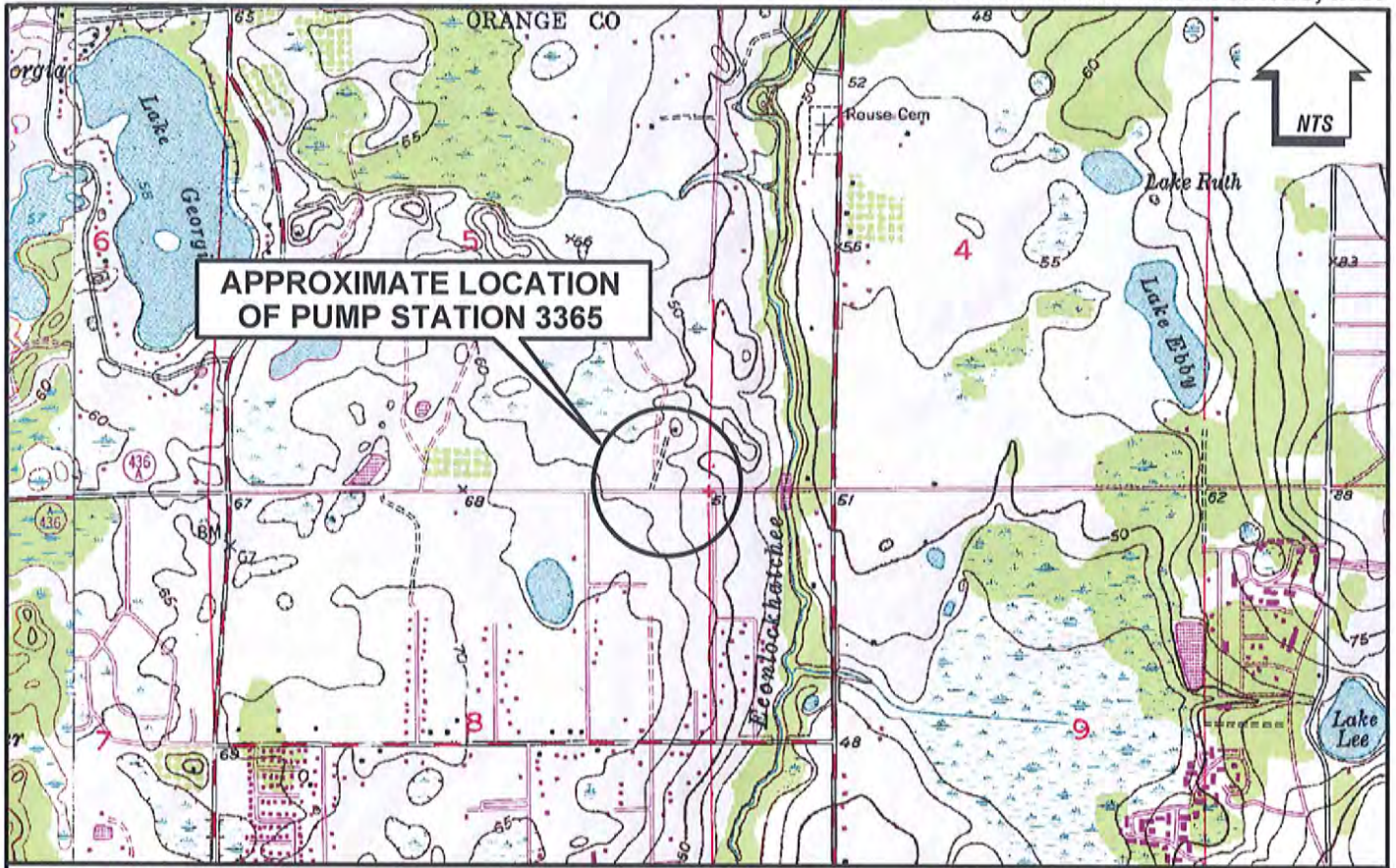

SITE LOCATION MAPS

201112-4

PACKAGE 1 PUMP STATION REHABILITATION

FIG. 1

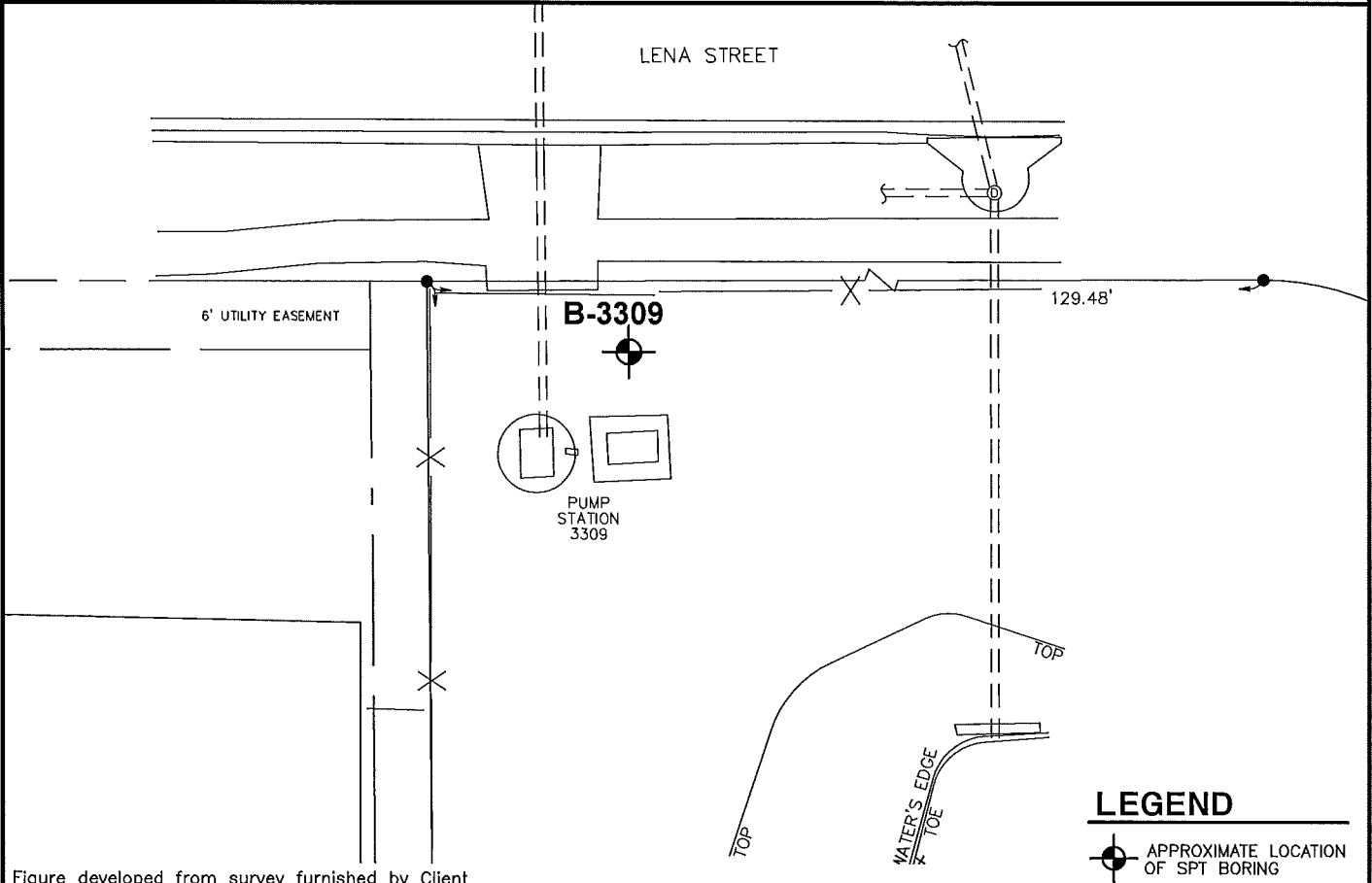
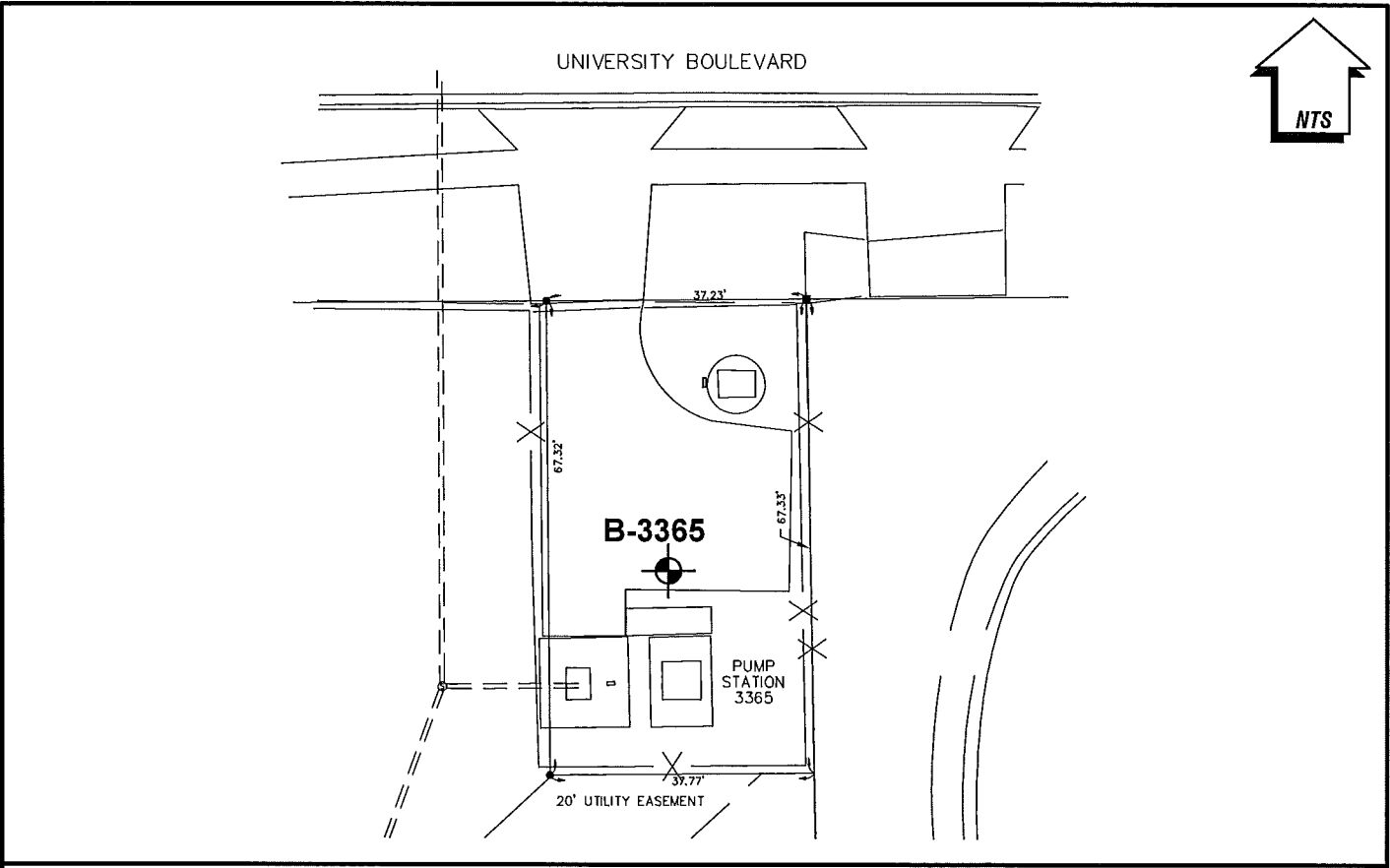

LEGEND

APPROXIMATE LOCATION OF SPT BORING

Figure developed from survey furnished by Client

EXPLORATION LOCATION PLANS

201112-4	PACKAGE 1 PUMP STATION REHABILITATION	FIG. 2
----------	---------------------------------------	--------

S:\Current Projects\BFA OCU Continuing Wastewater Y11-902-A\201112-4 Package 1 Pump Station Rehab\AEA Drawings\Package 1 Master.dwg, Location Plan - Double Viewport, 11/19/2012 3:39:39 PM

APPENDIX A



KEY TO BORING LOGS

SYMBOLS	
10	SPT N-Value (number of blows a 140-lb weight falling 30 inches required to drive a Standard Split-Spoon sampler one foot into otherwise undisturbed soil)
WR	Penetration of sampler under weight of drill rods
WH	Penetration of sampler under weight of drill rods and hammer
SS	Split Spoon sample
ST	Undisturbed thin-walled Shelby Tube sample
—	Observed change in soil type
- - -	Unobserved change in soil type
▽	Estimated seasonal high groundwater level
▼	Encountered groundwater level

SOIL CONSISTENCY	
(Based on empirical correlation with SPT N-Value)	
GRANULAR SOILS	
Very Loose - Less Than 4 blows/ft.	
Loose - 4 to 10 blows/ft.	
Medium Dense - 10 to 30 blows/ft.	
Dense - 30 to 50 blows/ft.	
Very Dense - More Than 50 blows/ft.	
FINE-GRAINED SOILS	
Very Soft - Less Than 2 blows/ft.	
Soft - 2 to 4 blows/ft.	
Firm - 4 to 8 blows/ft.	
Stiff - 8 to 15 blows/ft.	
Very Stiff - 15 to 30 blows/ft.	
Hard - More Than 30 blows/ft.	

UNIFIED SOILS CLASSIFICATION SYSTEM			
ASTM D 2487			
(Based on material passing the 3-inch (75-mm) sieve)			
MAJOR DIVISIONS		GROUP SYMBOLS	TYPICAL NAMES
COARSE-GRAINED SOILS	GRAVELS 50% or more of coarse fraction retained on No. 4 sieve	CLEAN GRAVELS	GW Well-graded gravels and gravel-sand mixtures, little or no fines
		GRAVELS WITH FINES	GP Poorly graded gravels and gravel-sand mixtures, little or no fines
			GM Silty gravels, gravel-sand-silt mixtures
	SANDS More than 50% of coarse fraction passes No. 4 sieve	CLEAN SANDS	GC Clayey gravels, gravel-sand-clay mixtures
		SANDS WITH FINES	SW Well-graded sands and gravelly sands, little or no fines
			SP Poorly graded sands and gravelly sands, little or no fines
FINE-GRAINED SOILS	SILTS AND CLAYS Liquid limit 50% or less		SM Silty sands, sand-silt mixtures
			SC Clayey sands, sand-clay mixtures
	SILTS AND CLAYS Liquid limit greater than 50%		ML Inorganic silts, very fine sands, rock flour, silty or clayey fine sands
			CL Inorganic clays of low to medium plasticity, gravelly clays, sandy clays, silty clays, lean clays
			OL Organic silts and organic silty clays of low plasticity
HIGHLY ORGANIC SOILS		MH Inorganic silts, micaceous or diatomaceous fine sands or silts, elastic silts	
		CH Inorganic clays or high plasticity, fat clays	
		OH Organic clays of medium to high plasticity	
Pt		Peat, muck and other highly organic soils	

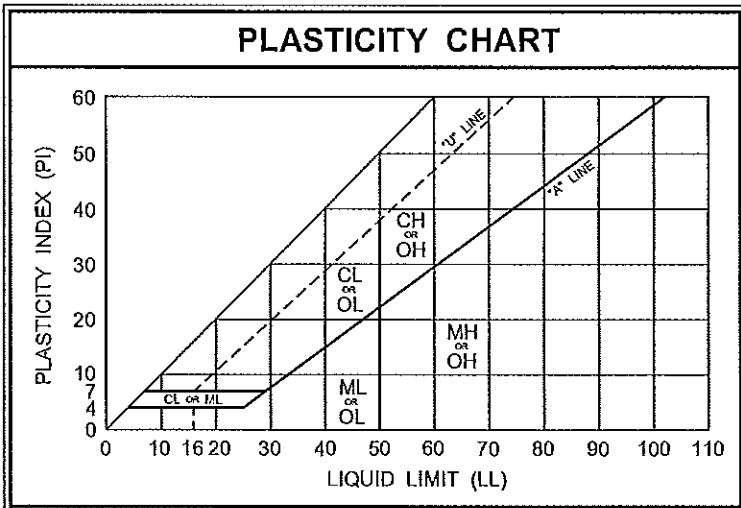



LOG OF BORING B-3309

SHEET 1 OF 1

PROJECT NO: 201112-4	SURFACE ELEVATION: Unknown
PROJECT: Package 1 Pump Station Rehabilitation	GROUNDWATER DEPTH: 12.0
DATE: 10/12/12	COMPLETION DEPTH: 30.0
LOCATION: See Figure 2	DRILLING METHOD: Mud Rotary

DEPTH, ft.	SAMPLES	SPT N-VALUE (bpf)	SAMPLE TYPE	DESCRIPTION	STRATUM EL / DEPTH	SYMBOL	- 200	MC %	LL	PI	OC %
0				Brown fine sand with silt (SP-SM) mixed with gravel							
9			SS	- loose							
13			SS	- medium dense, dark brown, mixed with clayey sands, trace gravel							
7			SS	- loose							
5				(POSSIBLE FILL)							
8			SS	Loose, dark brownish gray, silty fine SAND (SM)	6.0		12				
7			SS								
3			SS	- very loose							
10	WOH		SS	- less silty							
4			SS	Loose, gray, clayey fine SAND (SC)	12.0		22				
11			SS	Medium dense, very light gray fine SAND (SP)	13.5						
15											
13			SS	Medium dense, gray clayey fine SAND (SC)	17.0		15				
20											
10			SS	- more clayey			38	34.3	27	9	
25				Loose, light grayish brown, fine SAND with silt (SP-SM)	24.5						
18			SS	- medium dense, gray							
30					30.0						



LOG OF BORING B-3365

SHEET 1 OF 1

PROJECT NO: 201112-4	SURFACE ELEVATION: Unknown
PROJECT: Package 1 Pump Station Rehabilitation	GROUNDWATER DEPTH: 4.0
DATE: 10/12/12	COMPLETION DEPTH: 30.0
LOCATION: See Figure 2	DRILLING METHOD: Mud Rotary

DEPTH, ft.	SAMPLES	SPT N-VALUE (bpf)	SAMPLE TYPE	DESCRIPTION	STRATUM EL / DEPTH	SYMBOL	- 200	MC %	LL	PI	OC %
0				3 inch asphalt and 15 inch limerock (PAVEMENT)							
17			SS	Medium dense, brown fine SAND with silt (SP-SM)	1.5						
20			SS								
5			11	SS - dark grayish brown			6				
			11	SS - dark brown, less silt							
			16	SS			4				
			15	SS							
10											
			4	SS Very loose, dark brown, silty fine SAND with organic fines (SM)	12.0		25	38.7			19.5
15											
			32	SS Dense, dark grayish brown fine SAND with silt (SP-SM) with trace wood and roots	17.0						
20											
			21	SS - medium dense, less silt, more wood and roots							
25											
			20	SS - dark brown, more silt, no wood or roots							
30					30.0						

Project: **Package 1 Pump Station Rehabilitation**

Job Number: **201112-4**

Sheet **1** of **1**

Manager: _____ Client: _____ Project Description: _____
 Location: **See Figure 2** _____

Boring Depth	Sample Description					Fines #200	Water Content	LL	PI	Organic Content	k (ft/day)	AASHTO	USCS
	#4	#10	#40	#60	#100								
B-3309 6.0	Dark brownish gray silty fine sand					11.8							
B-3309 12.5	Gray clayey fine sand					21.5							
B-3309 18.5	Gray clayey fine sand					14.6							
B-3309 23.5	Gray clayey fine sand					38.4	34.3	27.3	8.8				
B-3365 4.0	Brown fine sand with silt					6.4							
B-3365 7.0	Brown fine sand					4.1							
B-3365 13.5	Dark brown silty fine sand with organic fines					25.0	38.7			19.5			

**Summary Of
Laboratory Test Results**



APPENDIX B

IMPORTANT INFORMATION ABOUT YOUR GEOTECHNICAL ENGINEERING REPORT

More construction problems are caused by site subsurface conditions than any other factor. As troublesome as subsurface problems can be, their frequency and extent have been lessened considerably in recent years, due in large measure to programs and publications of ASFE/ The Association of Engineering Firms Practicing in the Geosciences.

The following suggestions and observations are offered to help you reduce the geotechnical-related delays, cost-overruns and other costly headaches that can occur during a construction project.

A GEOTECHNICAL ENGINEERING REPORT IS BASED ON A UNIQUE SET OF PROJECT-SPECIFIC FACTORS

A geotechnical engineering report is based on a subsurface exploration plan designed to incorporate a unique set of project-specific factors. These typically include: the general nature of the structure involved, its size and configuration; the location of the structure on the site and its orientation; physical concomitants such as access roads, parking lots, and underground utilities, and the level of additional risk which the client assumed by virtue of limitations imposed upon the exploratory program. To help avoid costly problems, consult the geotechnical engineer to determine how any factors which change subsequent to the date of the report may affect its recommendations.

Unless your consulting geotechnical engineer indicates otherwise, *your geotechnical engineering report should not be used:*

- When the nature of the proposed structure is changed, for example, if an office building will be erected instead of a parking garage, or if a refrigerated warehouse will be built instead of an unrefrigerated one;
- when the size or configuration of the proposed structure is altered;
- when the location or orientation of the proposed structure is modified;
- when there is a change of ownership, or
- for application to an adjacent site.

Geotechnical engineers cannot accept responsibility for problems which may develop if they are not consulted after factors considered in their report's development have changed.

MOST GEOTECHNICAL "FINDINGS" ARE PROFESSIONAL ESTIMATES

Site exploration identifies actual subsurface conditions only at those points where samples are taken, when they are taken. Data derived through sampling and subsequent laboratory testing are extrapolated by geo-

technical engineers who then render an opinion about overall subsurface conditions, their likely reaction to proposed construction activity, and appropriate foundation design. Even under optimal circumstances actual conditions may differ from those inferred to exist, because no geotechnical engineer, no matter how qualified, and no subsurface exploration program, no matter how comprehensive, can reveal what is hidden by earth, rock and time. The actual interface between materials may be far more gradual or abrupt than a report indicates. Actual conditions in areas not sampled may differ from predictions. *Nothing can be done to prevent the unanticipated, but steps can be taken to help minimize their impact.* For this reason, *most experienced owners retain their geotechnical consultants through the construction stage*, to identify variances, conduct additional tests which may be needed, and to recommend solutions to problems encountered on site.

SUBSURFACE CONDITIONS CAN CHANGE

Subsurface conditions may be modified by constantly-changing natural forces. Because a geotechnical engineering report is based on conditions which existed at the time of subsurface exploration, *construction decisions should not be based on a geotechnical engineering report whose adequacy may have been affected by time.* Speak with the geotechnical consultant to learn if additional tests are advisable before construction starts.

Construction operations at or adjacent to the site and natural events such as floods, earthquakes or groundwater fluctuations may also affect subsurface conditions and, thus, the continuing adequacy of a geotechnical report. The geotechnical engineer should be kept apprised of any such events, and should be consulted to determine if additional tests are necessary.

GEOTECHNICAL SERVICES ARE PERFORMED FOR SPECIFIC PURPOSES AND PERSONS

Geotechnical engineers' reports are prepared to meet the specific needs of specific individuals. A report prepared for a consulting civil engineer may not be adequate for a construction contractor, or even some other consulting civil engineer. Unless indicated otherwise, this report was prepared expressly for the client involved and expressly for purposes indicated by the client. Use by any other persons for any purpose, or by the client for a different purpose, may result in problems. *No individual other than the client should apply this report for its intended purpose without first conferring with the geotechnical engineer. No person should apply this report for any purpose other than that originally contemplated without first conferring with the geotechnical engineer.*

A GEOTECHNICAL ENGINEERING REPORT IS SUBJECT TO MISINTERPRETATION

Costly problems can occur when other design professionals develop their plans based on misinterpretations of a geotechnical engineering report. To help avoid these problems, the geotechnical engineer should be retained to work with other appropriate design professionals to explain relevant geotechnical findings and to review the adequacy of their plans and specifications relative to geotechnical issues.

BORING LOGS SHOULD NOT BE SEPARATED FROM THE ENGINEERING REPORT

Final boring logs are developed by geotechnical engineers based upon their interpretation of field logs (assembled by site personnel) and laboratory evaluation of field samples. Only final boring logs customarily are included in geotechnical engineering reports. *These logs should not under any circumstances be redrawn* for inclusion in architectural or other design drawings, because drafters may commit errors or omissions in the transfer process. Although photographic reproduction eliminates this problem, it does nothing to minimize the possibility of contractors misinterpreting the logs during bid preparation. When this occurs, delays, disputes and unanticipated costs are the all-too-frequent result.

To minimize the likelihood of boring log misinterpretation, *give contractors ready access to the complete geotechnical engineering report* prepared or authorized for their use. Those who do not provide such access may proceed un-

der the *mistaken* impression that simply disclaiming responsibility for the accuracy of subsurface information always insulates them from attendant liability. Providing the best available information to contractors helps prevent costly construction problems and the adversarial attitudes which aggravate them to disproportionate scale.

READ RESPONSIBILITY CLAUSES CLOSELY

Because geotechnical engineering is based extensively on judgment and opinion, it is far less exact than other design disciplines. This situation has resulted in wholly unwarranted claims being lodged against geotechnical consultants. To help prevent this problem, geotechnical engineers have developed model clauses for use in written transmittals. These are *not* exculpatory clauses designed to foist geotechnical engineers' liabilities onto someone else. Rather, they are definitive clauses which identify where geotechnical engineers' responsibilities begin and end. Their use helps all parties involved recognize their individual responsibilities and take appropriate action. Some of these definitive clauses are likely to appear in your geotechnical engineering report, and you are encouraged to read them closely. Your geotechnical engineer will be pleased to give full and frank answers to your questions.

OTHER STEPS YOU CAN TAKE TO REDUCE RISK

Your consulting geotechnical engineer will be pleased to discuss other techniques which can be employed to mitigate risk. In addition, ASFE has developed a variety of materials which may be beneficial. Contact ASFE for a complimentary copy of its publications directory.

Published by

ASFE THE ASSOCIATION
OF ENGINEERING FIRMS
PRACTICING IN THE GEOSCIENCES

8811 Colesville Road/Suite G106/Silver Spring, Maryland 20910/(301) 565-2733

APPENDIX C

ANTILLIAN ENGINEERING ASSOCIATES, INC. CONSTRAINTS AND RESTRICTIONS

WARRANTY

Antillian Engineering Associates, Inc. has prepared this report for our client for his exclusive use, in accordance with generally accepted soil and foundation engineering practices, and makes no other warranty either expressed or implied as to the professional advice provided in the report.

UNANTICIPATED SOIL CONDITIONS

The analysis and recommendations submitted in this report are based upon the data obtained from soil borings performed at the locations indicated on the Boring Location Plan. This report does not reflect any variations which may occur between these borings.

CHANGED CONDITIONS

We recommend that the specifications for the project require that the contractor immediately notify Antillian Engineering Associates, Inc., as well as the owner, when subsurface conditions are encountered that are different from those present in this report.

No claim by the contractor for any conditions differing from those anticipated in the plans, specifications, and those found in this report, should be allowed unless the contractor notifies the owner and Antillian Engineering Associates, Inc. of such changed conditions. Further, we recommend that all foundation work and site improvements be observed by a representative of Antillian Engineering Associates, Inc. to monitor field conditions and changes, to verify design assumptions and to evaluate and recommend any appropriate modifications to this report.

MISINTERPRETATION OF SOIL ENGINEERING REPORT

Antillian Engineering Associates, Inc. is responsible for the conclusions and opinions contained within this report based upon the data relating only to the specific project and location discussed herein. If the conclusions or recommendations based upon the data presented are made by others, those conclusions or recommendations are not the responsibility of Antillian Engineering Associates, Inc..

CHANGED STRUCTURE OR LOCATION

This report was prepared in order to aid in the evaluation of this project and to assist the architect or engineer in the design of this project. If any changes in the design or location of the structure as outlined in this report are planned, or if any structures are included or added that are not discussed in the report, the conclusions and recommendations contained in this report shall not be considered valid unless the changes are reviewed and the conclusions modified or approved by Antillian Engineering Associates, Inc..

USE OF REPORT BY BIDDERS

Bidders who are examining the report prior to submission of a bid are cautioned that this report was prepared as an aid to the designers of the project and it may affect actual construction operations.

Bidders are urged to make their own soil borings, test pits, test caissons or other investigations to determine those conditions that may affect construction operations. Antillian Engineering Associates, Inc. cannot be responsible for any interpretations made from this report or the attached boring logs with regard to their adequacy in reflecting subsurface conditions which will affect construction operations.

STRATA CHANGES

Strata changes are indicated by a definite line on the boring logs which accompany this report. However, the actual change in the ground may be more gradual. Where changes occur between soil samples, the location of the change must necessarily be estimated using all available information and may not be shown at the exact depth.

OBSERVATIONS DURING DRILLING

Attempts are made to detect and/or identify occurrences during drilling and sampling, such as: water level, boulders, zones of lost circulation, relative ease or resistance to drilling progress, unusual sample recovery, variation of driving resistance, obstructions, etc.; however, lack of mention does not preclude their presence.

WATER LEVELS

Water level readings have been made in the drill holes during drilling and they indicate normally occurring conditions. Water levels may not have been stabilized at the last reading. This data has been reviewed and interpretations made in this report. However, it must be noted that fluctuations in the level of the groundwater may occur due to variations in rainfall, temperature, tides, and other factors not evident at the time measurements were made and reported. Since the probability of such variations is anticipated, design drawings and specifications should accommodate such possibilities and construction planning should be based upon such assumptions of variations.

LOCATION OF BURIED OBJECTS

All users of this report are cautioned that there was no requirement for Antillian Engineering Associates, Inc. to attempt to locate any man-made buried objects during the course of this exploration and that no attempt was made by Antillian Engineering Associates, Inc. to locate any such buried objects. Antillian Engineering Associates, Inc. cannot be responsible for any buried man-made objects which are subsequently encountered during construction that are not discussed within the text of this report.

TIME

This report reflects the soil conditions at the time of investigation. If the report is not used in a reasonable amount of time, significant changes to the site may occur and additional reviews may be required.

Barnes, Ferland, and Associates, Inc.

***1230 Hillcrest Street
(407) 896-8608***

***Orlando, Florida 32803
Fax (407) 896-1822***

MEMORANDUM

BFA #2011-11.13

TO: Mr. Tad Parker, P.E., Orange County Utilities
FROM: John Watson, P.H., Barnes Ferland and Associates, Inc.
DATE: June 6, 2013

**SUBJECT: Orange County Contract Y11-902A Subtask 420.
Ground Water Sampling and Laboratory Screening Results at Pump Station Nos. 3365 and 3309.**

This memo is to present the results of Barnes Ferland and Associates, Inc.'s (BFA) groundwater quality sampling and screening analysis performed for Orange County Utility's (OCU) Pump Station R & R Package 1 Pump Station No. 3309 (Lena Street) and No. 3365 (University Blvd. and Rouse Rd.). The overall Project will involve improvements at each pump station generally consisting of wet well rehabilitation and lining which will require dewatering (Figure 1).

Objective:

The Contractor selected for the Project will need to perform construction dewatering in order to complete the proposed wet well improvements "in the dry" as will be required by the contract documents. Therefore, at least 30 days prior to performing construction dewatering for the project, the Contractor is required by FDEP to submit a *Generic Permit for the Discharge of Produced Groundwater from any Non-Contaminated Site Activity - FDEP Document No. 62-621.300(2)* (attached). As part of the Generic Permit, the Contractor shall first sample, test and report to FDEP that the groundwater to be discharged does not contain contaminants above the maximum acceptable parameters listed in Table 1 of the Generic Permit. However, if any of the analytical test results exceed the screening values listed in Table 1, except TOC, the project will not qualify under the Generic Permit and the Contractor will be required to apply for an Individual Wastewater Application at least 90 days prior to the date of discharge to surface waters of the State.

Orange County recognizes the potential delays this permitting process may have on the Project. The actual start date of construction of the proposed transmission mains is dependent on the quality of the groundwater to be discharged during construction dewatering. The objective of BFA's ground water sampling and screening analysis, during this preliminary phase of the project, is to detect the presence of parameters listed in Table 1 of the Generic Permit and provide the results prior to bidding the construction project.

Pump Station Nos. 3365 and 3309
Groundwater Sampling and Analysis Results
Page 2
June 6, 2013

Methodology:

BFA obtained one groundwater sample at each pump station collected from temporary piezometers (Figures 1 & 2). For each sample location, BFA first manually excavated to the ground water table with a post-hole digger, then beyond with a manual stainless steel hand auger. We then inserted a 1-inch diameter ten-slot per inch 1/100" screened piezometer into the excavation and below the water table. A silica sand filter pack was also placed in the annulus above the water table. Utilizing a peristaltic pump, we drew ground water through the piezometer at a relatively high volume for approximately 45 minutes followed by a low volume withdrawal for approximately 15 minutes to reduce turbidity as much as possible prior to collecting the ground water samples. Once the groundwater was visibly clear, then samples were collected, labeled, placed in a cooler w/ice and delivered to a certified testing laboratory for analysis with respect to the parameters listed in Table 1 of the Generic Permit.

Results:

Below is a summary table of laboratory results, followed by laboratory reports prepared by Accutest.

Parameter	Screening Value	Pump Sta. 3365 (B1) University and Rouse	Pump Sta. 3309 (B2) Lena Street
Total Organic Carbon (TOC)	10 mg/L	17.1	5.8
pH, standard units	6.0-8.5	5.86	7.38
Total Recoverable Mercury	0.012 µg/L	0.014	0.0024
Total Recoverable Cadmium	9.3 µg/L	0.5 U	0.5 U
Total Recoverable Copper	2.9 µg/L	1.0 U	1.0 U
Total Recoverable Lead	0.03 mg/L	0.0011 U	0.0011 U
Total Recoverable Zinc	86.0 µg/L	12.3 I	5.4 I
Total Recoverable Chromium (Hex)	11.0 µg/L	8.0 U	8.0 U
Benzene	1.0 µg/L	0.21 U	0.21 U
Napthalene	100.0 µg/L	1.0 U	1.0 U
Hardness, total as CaCO3	mg/L	79.8	112

BFA performed a site search for contaminated sites using the FDEP Contamination Locator Map (CLEM). No sites were identified within a half mile radius of each of these pump stations (Figures 4 & 5). No FDEP screening values were exceeded at Pump Station 3309 at Lena Street. At Pump Station 3365 (University and Rouse), the FDEP screening values were exceeded for total organic carbon, a low pH and mercury. Because the laboratory results indicate that TOC, pH and mercury exceed the FDEP screening criteria, the dewatering discharge may not be covered by the Generic Permit. The TOC and pH compounds likely occur naturally and may be exempt if demonstrated by the permittee. Re-sampling of mercury may result in concentrations below the screening values due to seasonal/recharge variations. However, if any of the re-sampled analytical test results exceed the screening values listed in Table 1, the project will likely not qualify under the Generic Permit and the Contractor would be required to apply for an Individual Wastewater Application at least 90 days prior to the date of discharge to surface waters of the State. No discharge is permissible without an effective permit. Additional treatment of

discharge water for adverse contaminants may be required in accordance with the FDEP permit conditions and the County's project Dewatering Specifications (Section 02140-3.03).

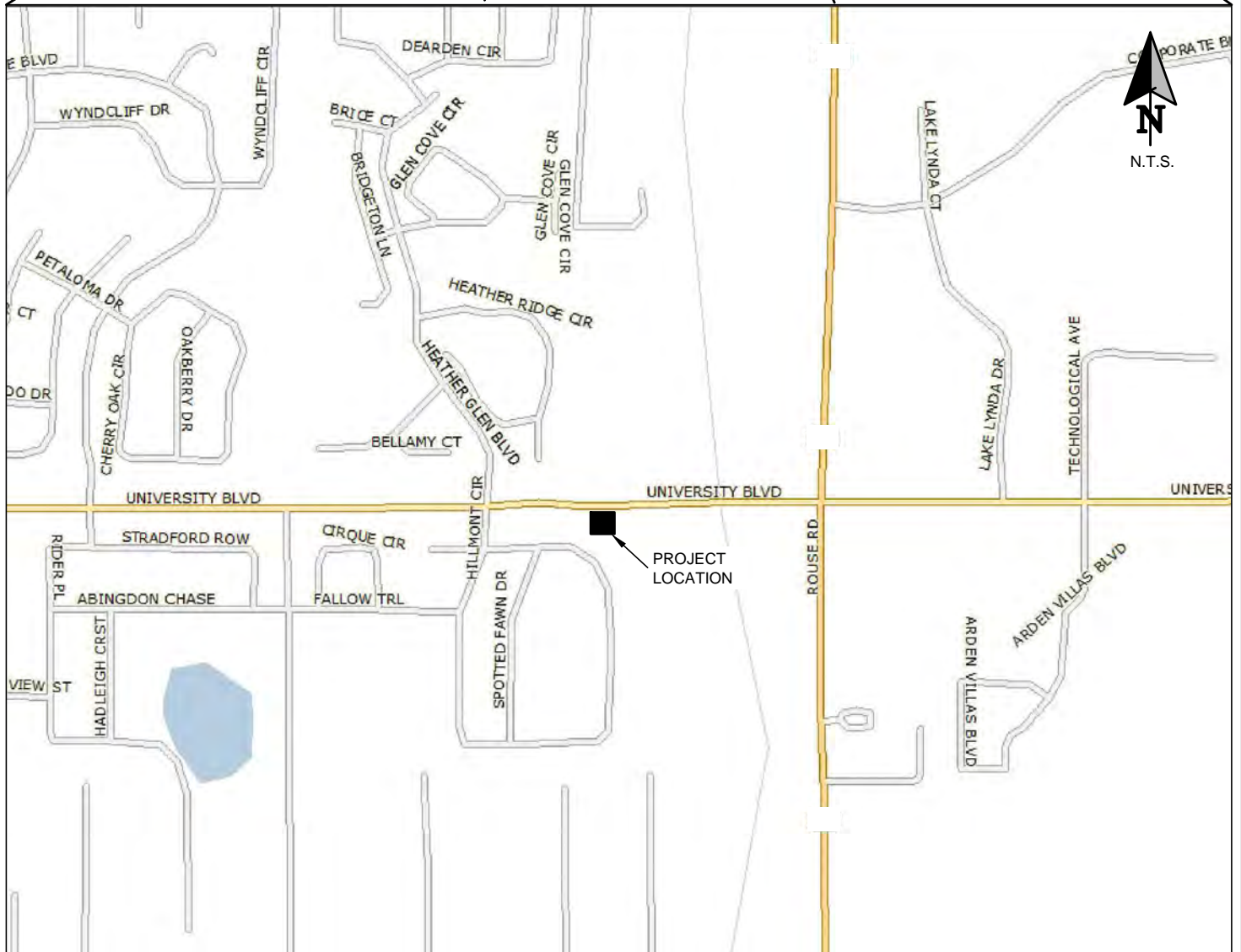
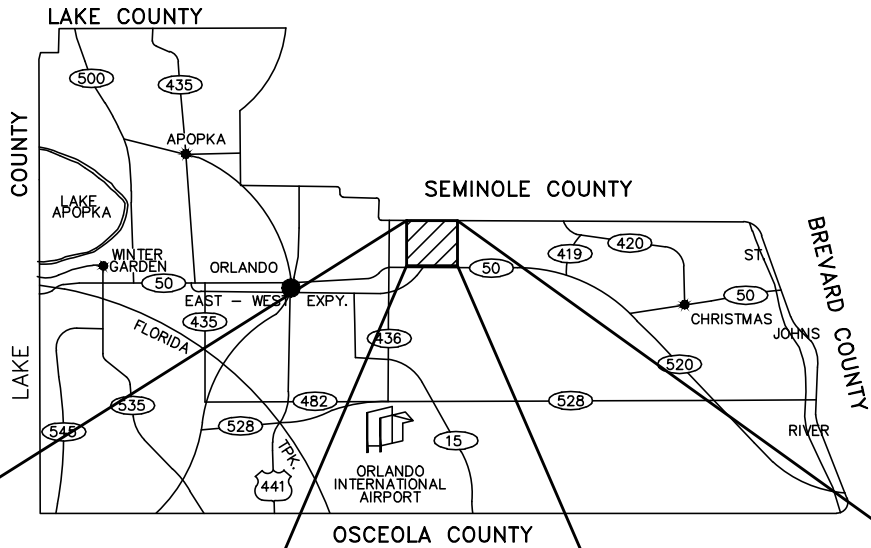

F:\CIVIL\PROJECTS\2011\2011-11 OCU Continuing\11-11-13 Package 1 Pump Stations\5.0 Drawings\2011-11-13 Package 1 Pump Stations Figure 1.dwg
 Monday, January 07, 2013 11:57:30 AM

ORANGE COUNTY
 ORANGE COUNTY UTILITIES
 ENGINEERING DIVISION
 5190 CURRY FORD ROAD
 ORLANDO, FL 32825

BFA Environmental Consultants
Barnes, Ferland and Associates, Inc.
 1230 E. Hillcrest Street, Orlando, FL 32803
 TEL: (407) 895-9999 FAX: (407) 895-7999
ENGINEERING BUSINESS No. 6899

R&R Package 1 Pump Station Improvements
 PRELIMINARY DESIGN REPORT
University and Rouse PS #3365
LOCATION MAP

FIGURE
1

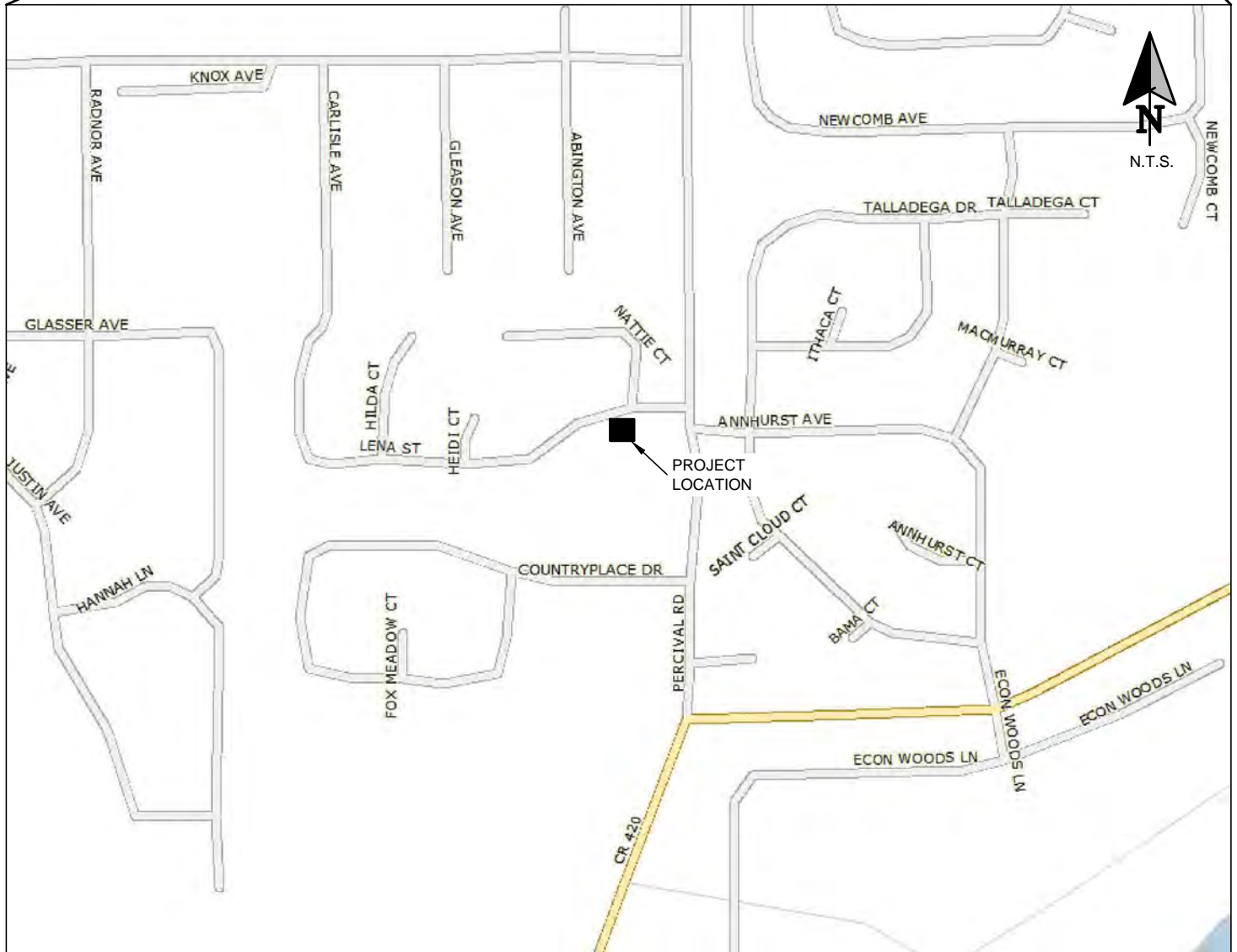
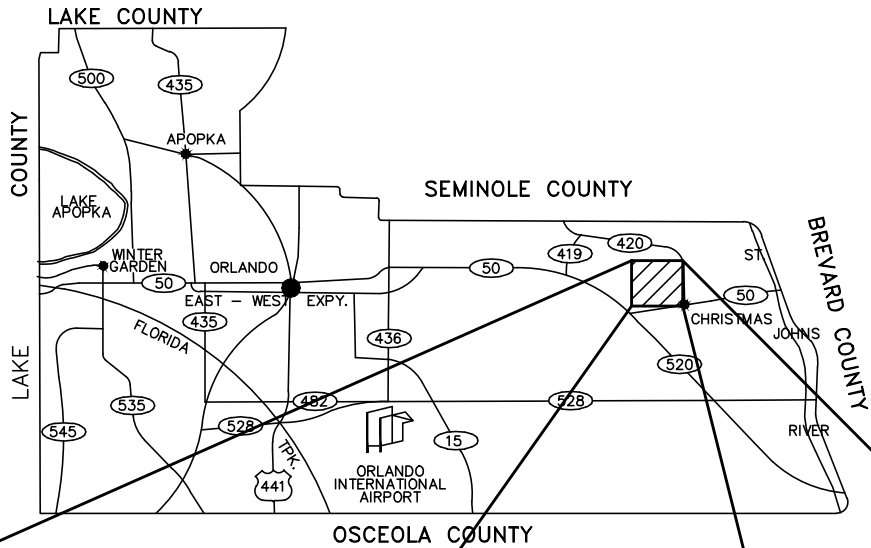

C:\CIVIL\PROJECTS\2011\2011-11 OCU Continuing\11-11-13 Package 1 Pump Stations\5.0 Drawings\2011-11-13 Package 1 Pump Stations Figure 2.dwg
Monday, January 07, 2013 11:57:30 AM

ORANGE COUNTY
 ORANGE COUNTY UTILITIES
 ENGINEERING DIVISION
 5190 CURRY FORD ROAD
 ORLANDO, FL 32825

BFA Environmental Consultants
Barnes, Ferland and Associates, Inc.
 1230 E. Hillcrest Street, Orlando, FL 32803
 P.O. BOX 6000-0000 TEL: 407-836-3300 FAX: 407-836-3300
 ENGINEERING BUSINESS No. 6899

R&R Package 1 Pump Station Improvements
 PRELIMINARY DESIGN REPORT
**Lena Street PS #3309
 LOCATION MAP**

**FIGURE
 2**



University and Rouse PS #3365 (Lab ID B1)



Lena Street PS#3309 (Lab ID B2)

Figure 3 - Groundwater Sampling Locations



Map Direct: Contamination Locator Map (CLM)

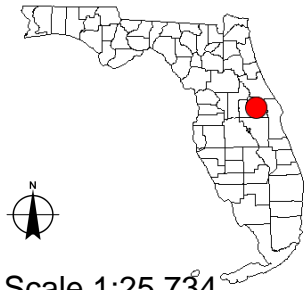

Scale 1:25,734

28°36'17.0367", -81°12'6.2148"

28°36'13.4937", -81°9'10.1453"

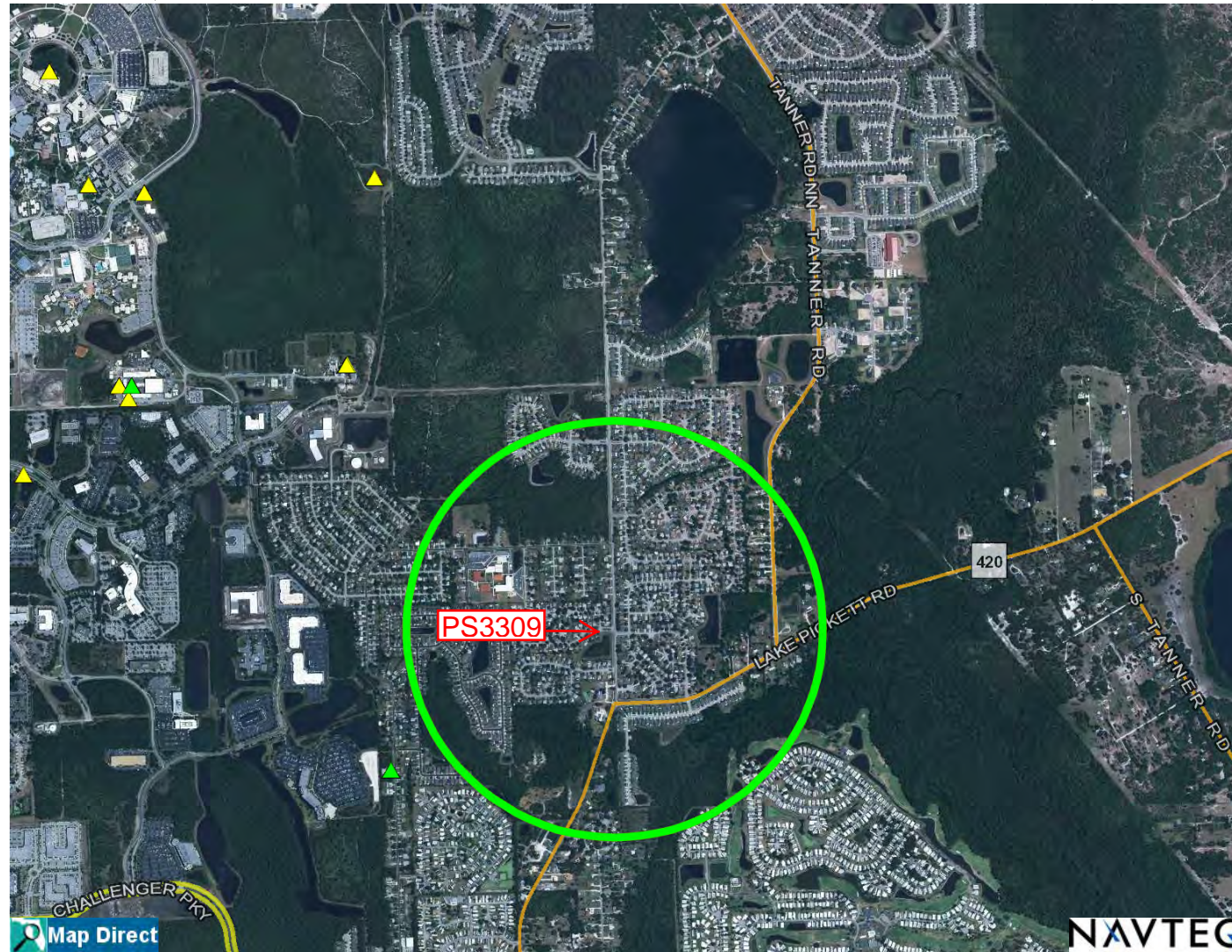

28°34'17.8839", -81°12'9.2907"

28°34'14.3421", -81°9'13.2749"

- Aerial Imagery 2004-2009
- DEP Cleanup Sites - Contamination Locator Map
 - PETROLEUM ▲
 - OTHER WASTE CLEANUP ▲
 - BROWNFIELD SITES ▲
 - SUPERFUND ▲
- Counties
- Aerial Imagery Flight Dates 2004-2009

Florida Department of Environmental Protection Disclaimer: This map created in Map Direct on Fri, 7 Jun 2013 15:12:52 UTC is intended for display purposes only. It was created using data from different sources collected at different scales, with different levels of accuracy, and/or covering different periods of time. NAVTEQ road data is provided "AS IS" and without warranties of any kind, either express or implied, including, but not limited to, the implied warranties of merchantability, fitness for a particular purpose, satisfactory quality and non-infringement. YOU SHOULD THEREFORE VERIFY ANY INFORMATION OBTAINED FROM THE SITE BEFORE ACTING ON IT.

PS 3309 Vicinity



Map Direct: Contamination Locator Map (CLM)

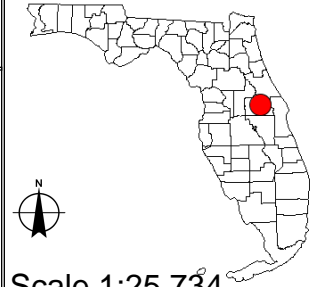

Scale 1:25,734

Aerial Imagery 2004-2009

DEP Cleanup Sites -
Contamination Locator Map
PETROLEUM



OTHER WASTE CLEANUP



BROWNFIELD SITES



SUPERFUND



Counties



Aerial Imagery Flight Dates
2004-2009

28°36'52.4587", -81°14'55.2864"

28°36'48.9747", -81°11'59.1994"

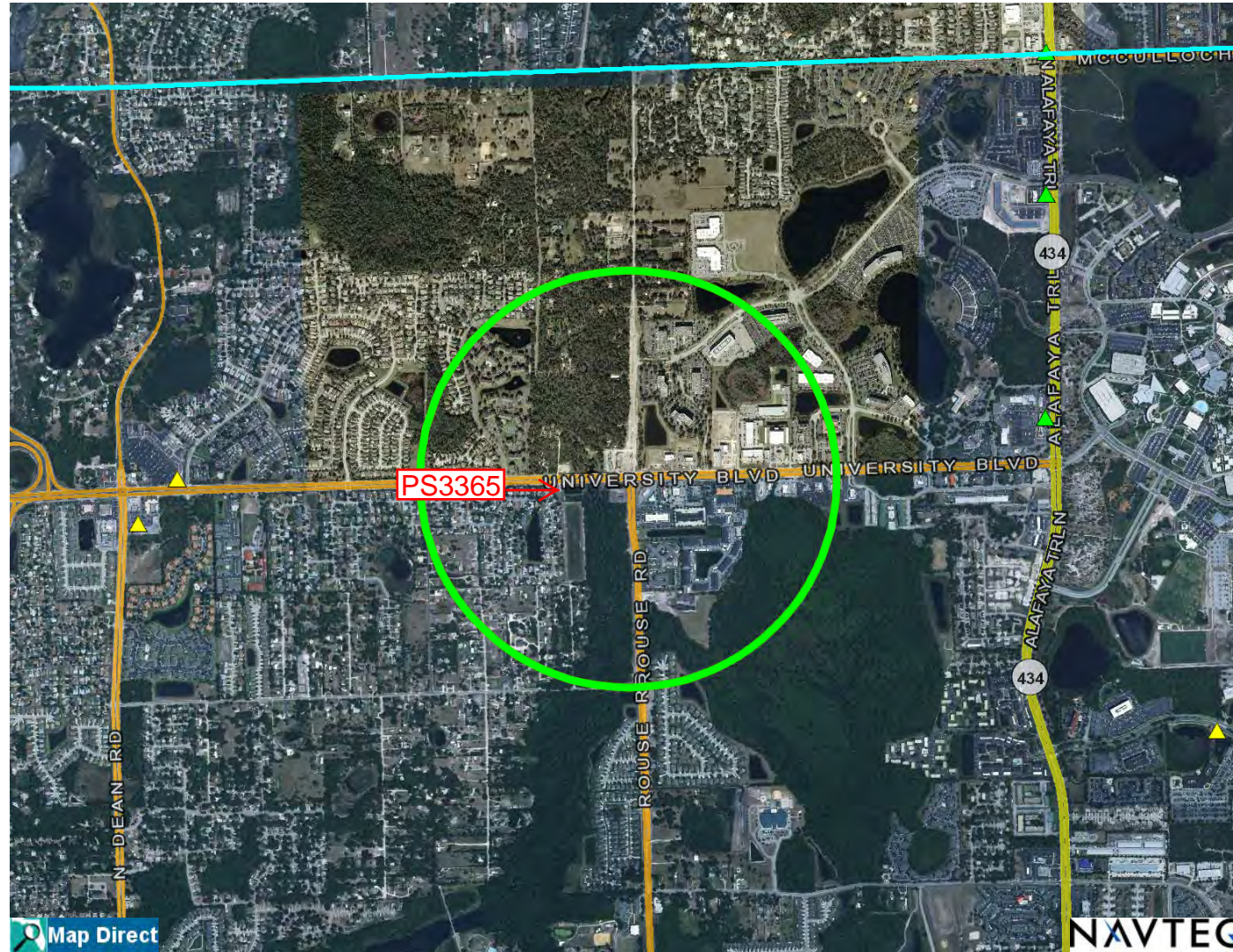

28°34'53.3048", -81°14'58.3110"

28°34'49.8219", -81°12'2.2777"

Florida Department of Environmental Protection Disclaimer: This map created in Map Direct on Fri, 7 Jun 2013 15:16:53 UTC is intended for display purposes only. It was created using data from different sources collected at different scales, with different levels of accuracy, and/or covering different periods of time. NAVTEQ road data is provided "AS IS" and without warranties of any kind, either express or implied, including, but not limited to, the implied warranties of merchantability, fitness for a particular purpose, satisfactory quality and non-infringement. YOU SHOULD THEREFORE VERIFY ANY INFORMATION OBTAINED FROM THE SITE BEFORE ACTING ON IT.

PS 3365

STATE OF FLORIDA

DEPARTMENT OF ENVIRONMENTAL PROTECTION

GENERIC PERMIT

FOR THE

DISCHARGE OF PRODUCED GROUND WATER

FROM ANY NON-CONTAMINATED SITE ACTIVITY

Generic Permit for the Discharge of Produced Ground Water from any Non-Contaminated Site Activity

(1) The facility is authorized to discharge produced ground water from any non-contaminated site activity which discharges by a point source to surface waters of the State, as defined in Chapter 62-620, F.A.C., only if the reported values for the parameters listed in Table 1 do not exceed any of the listed screening values. Before discharge of produced ground water can occur from such sites, analytical tests on samples of the proposed untreated discharge water shall be performed to determine if contamination exists.

(2) Minimum reporting requirements for all produced ground water dischargers. The effluent shall be sampled before the commencement of discharge, again within thirty (30) days after commencement of discharge, and then once every six (6) months for the life of the project to maintain continued coverage under this generic permit. Samples taken in compliance with the provisions of this permit shall be taken prior to actual discharge or mixing with the receiving waters. The effluent shall be sampled for the parameters listed in Table 1.

Table 1

Parameter	Screening Values for Discharges into:	
	Fresh Waters	Coastal Waters
Total Organic Carbon (TOC)	10.0 mg/l	10.0 mg/l
pH, standard units	6.0-8.5	6.5-8.5
Total Recoverable Mercury	0.012 µg/l	0.025 µg/l
Total Recoverable Cadmium	9.3 µg/l	9.3 µg/l
Total Recoverable Copper	2.9 µg/l	2.9 µg/l
Total Recoverable Lead	0.03 mg/l	5.6 µg/l
Total Recoverable Zinc	86.0 µg/l	86.0 µg/l
Total Recoverable Chromium (Hex.)	11.0 µg/l	50.0 µg/l
Benzene	1.0 µg/l	1.0 µg/l
Naphthalene	100.0 µg/l	100.0 µg/l

(3) If any of the analytical test results exceed the screening values listed in Table 1, except TOC, the discharge is not authorized by this permit.

(a) For initial TOC values that exceed the screening values listed in Table 1, which may be caused by naturally-occurring, high molecular weight organic compounds, the permittee may request to be exempted from the TOC requirement. To request this exemption, the permittee shall submit additional information with a Notice of Intent (NOI),

described below, which describes the method used to determine that these compounds are naturally occurring. The Department shall grant the exemption if the permittee affirmatively demonstrates that the TOC values are caused by naturally-occurring, high molecular weight organic compounds.

(b) The NOI shall be submitted to the appropriate Department district office thirty (30) days prior to discharge, and contain the following information:

1. the name and address of the person that the permit coverage will be issued to;
2. the name and address of the facility, including county location;
3. any applicable individual wastewater permit number(s);
4. a map showing the facility and discharge location (including latitude and longitude);
5. the name of the receiving water; and
6. the additional information required by paragraph (3)(a) of this permit.

(c) Discharge shall not commence until notification of coverage is received from the Department.

(4) For fresh waters and coastal waters, the pH of the effluent shall not be lowered to less than 6.0 units for fresh waters, or less than 6.5 units for coastal waters, or raised above 8.5 units, unless the permittee submits natural background data confirming a natural background pH outside of this range. If natural background of the receiving water is determined to be less than 6.0 units for fresh waters, or less than 6.5 units in coastal waters, the pH shall not vary below natural background or vary more than one (1) unit above natural background for fresh and coastal waters. If natural background of the receiving water is determined to be higher than 8.5 units, the pH shall not vary above natural background or vary more than one (1) unit below natural background of fresh and coastal waters. The permittee shall include the natural background pH of the receiving waters with the results of the analyses required under paragraph (2) of this permit. For purposes of this section only, fresh waters are those having a chloride concentration of less than 1500 mg/l, and coastal waters are those having a chloride concentration equal to or greater than 1500 mg/l.

(5) In accordance with Rule 62-302.500(1)(a-c), F.A.C., the discharge shall at all times be free from floating solids, visible foam, turbidity, or visible oil in such amounts as to form nuisances on surface waters.

(6) If contamination exists, as indicated by the results of the analytical tests required by paragraph (2), the discharge cannot be covered by this generic permit. The facility shall apply for an individual wastewater permit at least ninety (90) days prior to the date discharge to surface waters of the State is expected, or, if applicable, the facility may seek coverage under any other applicable Department generic permit. No discharge is permissible without an effective permit.

(7) If the analytical tests required by paragraph (2) reveal that no contamination exists from any source, the facility can begin discharge immediately and is covered by this permit without having to submit an NOI request for coverage to the Department. A short summary of the proposed activity and copy of the analytical tests shall be sent to the applicable Department district office within one (1) week after discharge begins. These analytical tests shall be kept on site during discharge and made available to the Department if requested. Additionally, no Discharge Monitoring Report forms are required to be submitted to the Department.

(8) All of the general conditions listed in Rule 62-621.250, F.A.C., are applicable to this generic permit.

(9) There are no annual fees associated with the use of this generic permit.

Technical Report for

BFA Environmental Consultants

Orange County Dewatering Screening; FL

3309/3365

Accutest Job Number: FA3595

Sampling Date: 04/11/13

Report to:

**BFA Environmental Consultants
1230 Hillcrest St Suite 100
Orlando, FL 32803
jwatson@bfaenvironmental.com**

ATTN: John Watson

Total number of pages in report: 38



Test results contained within this data package meet the requirements of the National Environmental Laboratory Accreditation Conference and/or state specific certification programs as applicable.



Harry Behzadi, Ph.D.
Laboratory Director

Client Service contact: Jean Dent-Smith 407-425-6700

Certifications: FL (E83510), LA (03051), KS (E-10327), IA (366), IL (200063), NC (573), NJ (FL002), SC (96038001)
DoD ELAP (L-A-B L2229), CA (04226CA), TX (T104704404), AK, AR, GA, KY, MA, NV, OK, UT, VA, WA, WI

This report shall not be reproduced, except in its entirety, without the written approval of Accutest Laboratories.
Test results relate only to samples analyzed.

Table of Contents

-1-

Section 1: Sample Summary	3
Section 2: Summary of Hits	4
Section 3: Sample Results	5
3.1: FA3595-1: B-2	6
3.2: FA3595-2: B-1	9
Section 4: Misc. Forms	12
4.1: Chain of Custody	13
Section 5: GC/MS Volatiles - QC Data Summaries	15
5.1: Method Blank Summary	16
5.2: Blank Spike Summary	17
5.3: Matrix Spike/Matrix Spike Duplicate Summary	18
Section 6: Metals Analysis - QC Data Summaries	19
6.1: Prep QC MP24976: Cd,Ca,Cu,Pb,Mg,Zn	20
Section 7: General Chemistry - QC Data Summaries	26
7.1: Method Blank and Spike Results Summary	27
7.2: Duplicate Results Summary	28
7.3: Matrix Spike Results Summary	29
7.4: Matrix Spike Duplicate Results Summary	30
Section 8: Misc. Forms (Accutest New Jersey)	31
8.1: Chain of Custody	32
Section 9: Metals Analysis - QC Data (Accutest New Jersey)	34
9.1: Prep QC MP71479: Hg	35

1

2

3

4

5

6

7

8

9



Sample Summary

BFA Environmental Consultants

Job No: FA3595

Orange County Dewatering Screening; FL
Project No: 3309/3365

Sample Number	Collected		Received	Matrix		Client Sample ID
	Date	Time By		Code	Type	
FA3595-1	04/11/13	12:43 DA	04/12/13	AQ	Ground Water	B-2
FA3595-2	04/11/13	15:02 DA	04/12/13	AQ	Ground Water	B-1

Summary of Hits

Job Number: FA3595
Account: BFA Environmental Consultants
Project: Orange County Dewatering Screening; FL
Collected: 04/11/13

Lab Sample ID	Client Sample ID	Result/ Qual	PQL	MDL	Units	Method
FA3595-1	B-2					
Calcium		43000	1000	50	ug/l	SW846 6010C
Magnesium		1030 I	5000	74	ug/l	SW846 6010C
Mercury ^a		2.4	0.50	0.28	ng/l	EPA 1631
Zinc		5.4 I	20	5.0	ug/l	SW846 6010C
Hardness, Total as CaCO ₃ ^b		112	23	0.43	mg/l	SM19 2340B
Total Organic Carbon		5.8	1.0	0.23	mg/l	SM19 5310B/SW 9060A
pH ^c		7.38			su	SM 4500H B/SW 9040C
FA3595-2	B-1					
Calcium		29700	1000	50	ug/l	SW846 6010C
Magnesium		1360 I	5000	74	ug/l	SW846 6010C
Mercury ^a		14.0	0.50	0.28	ng/l	EPA 1631
Zinc		12.3 I	20	5.0	ug/l	SW846 6010C
Hardness, Total as CaCO ₃ ^b		79.8	23	0.43	mg/l	SM19 2340B
Total Organic Carbon		17.1	1.0	0.23	mg/l	SM19 5310B/SW 9060A
pH ^c		5.86			su	SM 4500H B/SW 9040C

(a) Analysis performed at Accutest Laboratories, Dayton, NJ.

(b) Calculated as: (Calcium * 2.497) + (Magnesium * 4.118)

(c) Field analysis required. Received out of hold time and analyzed by request.



Sample Results

Report of Analysis

Report of Analysis

3.1
3

Client Sample ID: B-2	Date Sampled: 04/11/13
Lab Sample ID: FA3595-1	Date Received: 04/12/13
Matrix: AQ - Ground Water	Percent Solids: n/a
Method: SW846 8260B	
Project: Orange County Dewatering Screening; FL	

Run #	File ID	DF	Analyzed	By	Prep Date	Prep Batch	Analytical Batch
Run #1	O15629.D	1	04/23/13	MM	n/a	n/a	VO640
Run #2							

Run #	Purge Volume
Run #1	5.0 ml
Run #2	

CAS No.	Compound	Result	PQL	MDL	Units	Q
71-43-2	Benzene	0.21 U	1.0	0.21	ug/l	
91-20-3	Naphthalene	1.0 U	5.0	1.0	ug/l	

CAS No.	Surrogate Recoveries	Run# 1	Run# 2	Limits
1868-53-7	Dibromofluoromethane	104%		83-118%
17060-07-0	1,2-Dichloroethane-D4	108%		79-125%
2037-26-5	Toluene-D8	104%		85-112%
460-00-4	4-Bromofluorobenzene	105%		83-118%

U = Not detected MDL - Method Detection Limit
 PQL = Practical Quantitation Limit
 L = Indicates value exceeds calibration range

I = Result > = MDL but < PQL J = Estimated value
 V = Indicates analyte found in associated method blank
 N = Indicates presumptive evidence of a compound

Report of Analysis

Client Sample ID: B-2	Date Sampled: 04/11/13
Lab Sample ID: FA3595-1	Date Received: 04/12/13
Matrix: AQ - Ground Water	Percent Solids: n/a
Project: Orange County Dewatering Screening; FL	

Total Metals Analysis

Analyte	Result	PQL	MDL	Units	DF	Prep	Analyzed By	Method	Prep Method
Cadmium	0.50 U	5.0	0.50	ug/l	1	04/17/13	04/17/13 LM	SW846 6010C ¹	SW846 3010A ³
Calcium	43000	1000	50	ug/l	1	04/17/13	04/17/13 LM	SW846 6010C ¹	SW846 3010A ³
Copper	1.0 U	25	1.0	ug/l	1	04/17/13	04/17/13 LM	SW846 6010C ¹	SW846 3010A ³
Lead	1.1 U	5.0	1.1	ug/l	1	04/17/13	04/17/13 LM	SW846 6010C ¹	SW846 3010A ³
Magnesium	1030 I	5000	74	ug/l	1	04/17/13	04/17/13 LM	SW846 6010C ¹	SW846 3010A ³
Mercury ^a	2.4	0.50	0.28	ng/l	1	04/17/13	04/22/13 ANJ	EPA 1631 ²	EPA 1631 ⁴
Zinc	5.4 I	20	5.0	ug/l	1	04/17/13	04/17/13 LM	SW846 6010C ¹	SW846 3010A ³

- (1) Instrument QC Batch: MA10685
- (2) Instrument QC Batch: N:MA31019
- (3) Prep QC Batch: MP24976
- (4) Prep QC Batch: N:MP71479

(a) Analysis performed at Accutest Laboratories, Dayton, NJ.

PQL = Practical Quantitation Limit
 MDL = Method Detection Limit

U = Indicates a result < MDL
 I = Indicates a result > = MDL but < PQL

Report of Analysis

31
3

Client Sample ID: B-2	Date Sampled: 04/11/13
Lab Sample ID: FA3595-1	Date Received: 04/12/13
Matrix: AQ - Ground Water	Percent Solids: n/a
Project: Orange County Dewatering Screening; FL	

General Chemistry

Analyte	Result	PQL	MDL	Units	DF	Analyzed	By	Method
Chromium, Hexavalent	0.0080 U	0.010	0.0080	mg/l	1	04/12/13 11:37 FN	SW846	7196A
Hardness, Total as CaCO ₃ ^a	112	23	0.43	mg/l	1	04/17/13 20:02 LM	SM19	2340B
Total Organic Carbon	5.8	1.0	0.23	mg/l	1	04/17/13 11:39 FN	SM19	5310B/SW 9060A
pH ^b	7.38			su	1	04/12/13 12:25 HH	SM	4500H B/SW 9040C

(a) Calculated as: (Calcium * 2.497) + (Magnesium * 4.118)

(b) Field analysis required. Received out of hold time and analyzed by request.

PQL = Practical Quantitation Limit
MDL = Method Detection Limit

U = Indicates a result < MDL
I = Indicates a result > = MDL but < PQL

Report of Analysis

32
3

Client Sample ID: B-1	Date Sampled: 04/11/13
Lab Sample ID: FA3595-2	Date Received: 04/12/13
Matrix: AQ - Ground Water	Percent Solids: n/a
Method: SW846 8260B	
Project: Orange County Dewatering Screening; FL	

Run #	File ID	DF	Analyzed	By	Prep Date	Prep Batch	Analytical Batch
Run #1	O15630.D	1	04/23/13	MM	n/a	n/a	VO640
Run #2							

Run #	Purge Volume
Run #1	5.0 ml
Run #2	

CAS No.	Compound	Result	PQL	MDL	Units	Q
71-43-2	Benzene	0.21 U	1.0	0.21	ug/l	
91-20-3	Naphthalene	1.0 U	5.0	1.0	ug/l	

CAS No.	Surrogate Recoveries	Run# 1	Run# 2	Limits
1868-53-7	Dibromofluoromethane	106%		83-118%
17060-07-0	1,2-Dichloroethane-D4	109%		79-125%
2037-26-5	Toluene-D8	104%		85-112%
460-00-4	4-Bromofluorobenzene	104%		83-118%

U = Not detected MDL - Method Detection Limit
 PQL = Practical Quantitation Limit
 L = Indicates value exceeds calibration range

I = Result > = MDL but < PQL J = Estimated value
 V = Indicates analyte found in associated method blank
 N = Indicates presumptive evidence of a compound

Report of Analysis

Client Sample ID: B-1 Lab Sample ID: FA3595-2 Matrix: AQ - Ground Water Project: Orange County Dewatering Screening; FL	Date Sampled: 04/11/13 Date Received: 04/12/13 Percent Solids: n/a
--	---

Total Metals Analysis

Analyte	Result	PQL	MDL	Units	DF	Prep	Analyzed By	Method	Prep Method
Cadmium	0.50 U	5.0	0.50	ug/l	1	04/17/13	04/17/13 LM	SW846 6010C ¹	SW846 3010A ³
Calcium	29700	1000	50	ug/l	1	04/17/13	04/17/13 LM	SW846 6010C ¹	SW846 3010A ³
Copper	1.0 U	25	1.0	ug/l	1	04/17/13	04/17/13 LM	SW846 6010C ¹	SW846 3010A ³
Lead	1.1 U	5.0	1.1	ug/l	1	04/17/13	04/17/13 LM	SW846 6010C ¹	SW846 3010A ³
Magnesium	1360 I	5000	74	ug/l	1	04/17/13	04/17/13 LM	SW846 6010C ¹	SW846 3010A ³
Mercury ^a	14.0	0.50	0.28	ng/l	1	04/17/13	04/22/13 ANJ	EPA 1631 ²	EPA 1631 ⁴
Zinc	12.3 I	20	5.0	ug/l	1	04/17/13	04/17/13 LM	SW846 6010C ¹	SW846 3010A ³

- (1) Instrument QC Batch: MA10685
- (2) Instrument QC Batch: N:MA31019
- (3) Prep QC Batch: MP24976
- (4) Prep QC Batch: N:MP71479

(a) Analysis performed at Accutest Laboratories, Dayton, NJ.

PQL = Practical Quantitation Limit
 MDL = Method Detection Limit

U = Indicates a result < MDL
 I = Indicates a result > = MDL but < PQL

Report of Analysis

32
3

Client Sample ID: B-1	Date Sampled: 04/11/13
Lab Sample ID: FA3595-2	Date Received: 04/12/13
Matrix: AQ - Ground Water	Percent Solids: n/a
Project: Orange County Dewatering Screening; FL	

General Chemistry

Analyte	Result	PQL	MDL	Units	DF	Analyzed	By	Method
Chromium, Hexavalent	0.0080 U	0.010	0.0080	mg/l	1	04/12/13 11:37 FN	SW846	7196A
Hardness, Total as CaCO3 ^a	79.8	23	0.43	mg/l	1	04/17/13 20:26 LM	SM19	2340B
Total Organic Carbon	17.1	1.0	0.23	mg/l	1	04/17/13 11:54 FN	SM19	5310B/SW 9060A
pH ^b	5.86			su	1	04/12/13 12:25 HH	SM	4500H B/SW 9040C

(a) Calculated as: (Calcium * 2.497) + (Magnesium * 4.118)

(b) Field analysis required. Received out of hold time and analyzed by request.

PQL = Practical Quantitation Limit
MDL = Method Detection Limit

U = Indicates a result < MDL
I = Indicates a result > = MDL but < PQL

Misc. Forms

Custody Documents and Other Forms

Includes the following where applicable:

- Chain of Custody



Accutest Laboratories Southeast Chain of Custody

4405 Vineland Road, Suite C-15 Orlando, FL 32811
TEL: 407-425-6700 • FAX: 407-425-0707
www.accutest.com

Accutest JOB #

FA3595

PAGE 1 OF 1

Client / Reporting Information		Project Information										Accutest Quote #	SKIFF#															
Company Name: BFA		Project Name: Pump Station 3309, 3365										Analytical Information VOC TOC PCB, PAH, Hex Cd, Cu, Pb, Zn LLMs	Matrix Codes DW - Drinking Water GW - Ground Water WW - Water SW - Surface Water SO - Soil SL - Sludge OL - Oil LIQ - Other Liquid AIR - Air SOL - Other Solid WP - Wipe															
Address:		Street:																										
City:		City:																										
State:		State:																										
Zip:		Zip:																										
Project Contact:		Project #:										LAB USE ONLY																
E-mail:		Fax #:																										
Phone #:		Client Purchase Order #:																										
Sampler(s) Name(s) (Printed):		Client Purchase Order #:																										
Accutest Sample #	Field ID / Point of Collection	COLLECTION				CONTAINER INFORMATION																						
		DATE	TIME	SAMPLED BY	MATRIX	TOTAL # OF BOTTLES	OTHER	MINE	PC	SOX	WAX	GLASS	MACHINIC	IN WATER	MISC													
1	B-2	4.11.13	1243	DA	(2)	B		X	X	X																		
2	B-1	4.11.13	1507	DA	(2)	B		X	X	X																		

TURNAROUND TIME (Business Days)		Approved By: / Rush Code	Data Deliverable Information	Comments / Remarks
<input checked="" type="checkbox"/> 10 Days Standard <input type="checkbox"/> 7 Day RUSH <input type="checkbox"/> 5 Day RUSH <input type="checkbox"/> 3 Day EMERGENCY <input type="checkbox"/> 2 Day EMERGENCY <input type="checkbox"/> 1 Day EMERGENCY <input type="checkbox"/> OTHER			<input type="checkbox"/> COMMERCIAL "A" (RESULTS ONLY) <input type="checkbox"/> COMMERCIAL "B" (RESULTS PLUS QC) <input type="checkbox"/> REDT1 (EPA LEVEL 3) <input type="checkbox"/> FULT1 (EPA LEVEL 4) <input checked="" type="checkbox"/> EDD'S	
Emergency or Rush T/A Data Available VIA Email or Lablink				

Sample Custody must be documented below each time satisfactory change of possession, including courier delivery.							
Relinquished by Sampler:		Date Time:		Received By:		Date Time:	
1 [Signature]		4.11.13 1655		2 [Signature]		4.11.13 1638	
Relinquished by:		Date Time:		Received By:		Date Time:	
5				6		7	
Lab Use Only: Custody Seal in Place: Y N				Temp Blank Provided: Y N			
Preserved where Applicable: Y N				Total # of Coolers:			
				Cooler Temperature (s) Celsius: <u>3.0</u>			

4.1 4

ACCUTEST LABORATORIES SAMPLE RECEIPT CONFIRMATION

ACCUTEST'S JOB NUMBER: FA3595 CLIENT: BFA PROJECT: Pump Station 3309, 3365
 DATE/TIME RECEIVED: 04-12-13 800 (MM/DD/YY 24:00) NUMBER OF COOLERS RECEIVED: 1
 METHOD OF DELIVERY: FEDEX UPS ACCUTEST COURIER GREYHOUND DELIVERY OTHER
 AIRBILL NUMBERS: _____

COOLER INFORMATION

- CUSTODY SEAL NOT PRESENT OR NOT INTACT
- CHAIN OF CUSTODY NOT RECEIVED (COC)
- ANALYSIS REQUESTED IS UNCLEAR OR MISSING
- SAMPLE DATES OR TIMES UNCLEAR OR MISSING
- TEMPERATURE CRITERIA NOT MET
- WET ICE PRESENT

TRIP BLANK INFORMATION

- TRIP BLANK PROVIDED
- TRIP BLANK NOT PROVIDED
- TRIP BLANK NOT ON COC
- TRIP BLANK INTACT
- TRIP BLANK NOT INTACT
- RECEIVED WATER TRIP BLANK (2)
- RECEIVED SOIL TRIP BLANK

MISC. INFORMATION

NUMBER OF ENCORES? 25-GRAM _____ 5-GRAM _____
 NUMBER OF 5035 FIELD KITS? _____
 NUMBER OF LAB FILTERED METALS? _____

TEMPERATURE INFORMATION

- IR THERM ID 3 CORR. FACTOR to 4
- OBSERVED TEMPS: 2.6
- CORRECTED TEMPS: 3.0

SAMPLE INFORMATION

- SAMPLE LABELS PRESENT ON ALL BOTTLES
- INCORRECT NUMBER OF CONTAINERS USED
- SAMPLE RECEIVED IMPROPERLY PRESERVED
- INSUFFICIENT VOLUME FOR ANALYSIS
- DATES/TIMES ON COC DO NOT MATCH SAMPLE LABEL
- ID'S ON COC DO NOT MATCH LABEL
- VOC VIALS HAVE HEADSPACE (MACRO BUBBLES)
- BOTTLES RECEIVED BUT ANALYSIS NOT REQUESTED
- NO BOTTLES RECEIVED FOR ANALYSIS REQUESTED
- UNCLEAR FILTERING OR COMPOSITING INSTRUCTIONS
- SAMPLE CONTAINER(S) RECEIVED BROKEN
- % SOLIDS JAR NOT RECEIVED
- 5035 FIELD KIT FROZEN WITHIN 48 HOUR'S
- RESIDUAL CHLORINE PRESENT

(APPLICABLE TO EPA 600 SERIES OR NORTH CAROLINA ORGANICS)

SUMMARY OF COMMENTS: _____

TECHNICIAN SIGNATURE/DATE

R. Williams 04/12-13

REVIEWER SIGNATURE/DATE

[Signature] 04/12/13

NF 12/10

receipt confirmation 122910.xls

GC/MS Volatiles

5

QC Data Summaries

Includes the following where applicable:

- Method Blank Summaries
- Blank Spike Summaries
- Matrix Spike and Duplicate Summaries

Method Blank Summary

Job Number: FA3595
Account: BFACFLO BFA Environmental Consultants
Project: Orange County Dewatering Screening; FL

Sample	File ID	DF	Analyzed	By	Prep Date	Prep Batch	Analytical Batch
VO640-MB	O15623.D	1	04/23/13	MM	n/a	n/a	VO640

The QC reported here applies to the following samples:

Method: SW846 8260B

FA3595-1, FA3595-2

CAS No.	Compound	Result	RL	MDL	Units	Q
71-43-2	Benzene	ND	1.0	0.21	ug/l	
91-20-3	Naphthalene	ND	5.0	1.0	ug/l	

CAS No.	Surrogate Recoveries	Limits	
1868-53-7	Dibromofluoromethane	104%	83-118%
17060-07-0	1,2-Dichloroethane-D4	104%	79-125%
2037-26-5	Toluene-D8	101%	85-112%
460-00-4	4-Bromofluorobenzene	101%	83-118%

5.1.1
5

Blank Spike Summary

Job Number: FA3595
Account: BFACFLO BFA Environmental Consultants
Project: Orange County Dewatering Screening; FL

Sample	File ID	DF	Analyzed	By	Prep Date	Prep Batch	Analytical Batch
VO640-BS	O15622.D	1	04/23/13	MM	n/a	n/a	VO640

The QC reported here applies to the following samples:

Method: SW846 8260B

FA3595-1, FA3595-2

CAS No.	Compound	Spike ug/l	BSP ug/l	BSP %	Limits
71-43-2	Benzene	25	25.7	103	81-122
91-20-3	Naphthalene	25	19.2	77	63-132

CAS No.	Surrogate Recoveries	BSP	Limits
1868-53-7	Dibromofluoromethane	103%	83-118%
17060-07-0	1,2-Dichloroethane-D4	103%	79-125%
2037-26-5	Toluene-D8	97%	85-112%
460-00-4	4-Bromofluorobenzene	98%	83-118%

* = Outside of Control Limits.

Matrix Spike/Matrix Spike Duplicate Summary

Job Number: FA3595
Account: BFACFLO BFA Environmental Consultants
Project: Orange County Dewatering Screening; FL

Sample	File ID	DF	Analyzed	By	Prep Date	Prep Batch	Analytical Batch
FA3878-1MS	O15644.D	1	04/23/13	MM	n/a	n/a	VO640
FA3878-1MSD	O15645.D	1	04/23/13	MM	n/a	n/a	VO640
FA3878-1	O15631.D	1	04/23/13	MM	n/a	n/a	VO640

The QC reported here applies to the following samples:

Method: SW846 8260B

FA3595-1, FA3595-2

CAS No.	Compound	FA3878-1 ug/l	Spike Q ug/l	MS ug/l	MS %	MSD ug/l	MSD %	RPD	Limits Rec/RPD
71-43-2	Benzene	0.49	25	27.0	106	26.4	104	2	81-122/14
91-20-3	Naphthalene	5.0 U	25	17.8	71	20.8	83	16	63-132/25

CAS No.	Surrogate Recoveries	MS	MSD	FA3878-1	Limits
1868-53-7	Dibromofluoromethane	105%	106%	107%	83-118%
17060-07-0	1,2-Dichloroethane-D4	108%	107%	111%	79-125%
2037-26-5	Toluene-D8	93%	96%	102%	85-112%
460-00-4	4-Bromofluorobenzene	98%	98%	106%	83-118%

* = Outside of Control Limits.

5.3.1
 5

Metals Analysis

QC Data Summaries

Includes the following where applicable:

- Method Blank Summaries
- Matrix Spike and Duplicate Summaries
- Blank Spike and Lab Control Sample Summaries
- Serial Dilution Summaries

BLANK RESULTS SUMMARY
Part 2 - Method Blanks

Login Number: FA3595
Account: BFACFLO - BFA Environmental Consultants
Project: Orange County Dewatering Screening; FL

QC Batch ID: MP24976
Matrix Type: AQUEOUS

Methods: SW846 6010C
Units: ug/l

Prep Date: 04/17/13 04/17/13

Metal	RL	IDL	MDL	MB raw	final	MB raw	final
Aluminum	200	15	15				
Antimony	6.0	1.3	1.3				
Arsenic	10	1.6	2.5				
Barium	200	1	1				
Beryllium	4.0	.5	.5				
Cadmium	5.0	.5	.5	0.0	<5.0	-0.10	<5.0
Calcium	1000	50	50	2.2	<1000	3.7	<1000
Chromium	10	1.8	2				
Cobalt	50	.5	.5				
Copper	25	1	1	0.70	<25	0.20	<25
Iron	300	29	29				
Lead	5.0	1.1	1.1	-0.30	<5.0	-0.60	<5.0
Magnesium	5000	74	74	-2.8	<5000	9.5	<5000
Manganese	15	.7	.7				
Molybdenum	50	.6	1				
Nickel	40	.5	.5				
Potassium	10000	200	200				
Selenium	10	2	2				
Silver	10	.5	.5				
Sodium	10000	500	500				
Strontium	10	.5	.5				
Thallium	10	1.3	1.3				
Tin	50	.7	1.8				
Titanium	10	.9	1				
Vanadium	50	.5	1				
Zinc	20	3	5	2.2	<20	5.1	<20

Associated samples MP24976: FA3595-1, FA3595-2

Results < IDL are shown as zero for calculation purposes
(*) Outside of QC limits
(anr) Analyte not requested

6.1.1
6

MATRIX SPIKE AND DUPLICATE RESULTS SUMMARY

Login Number: FA3595
 Account: BFACFLO - BFA Environmental Consultants
 Project: Orange County Dewatering Screening; FL

QC Batch ID: MP24976
 Matrix Type: AQUEOUS

Methods: SW846 6010C
 Units: ug/l

Prep Date: 04/17/13 04/17/13

Metal	FA3595-1 Original	DUP	RPD	QC Limits	FA3595-1 Original MS	Spikelot MPFLICP1	% Rec	QC Limits	
Aluminum									
Antimony									
Arsenic	anr								
Barium									
Beryllium									
Cadmium	0.0	0.0	NC	0-20	0.0	48.2	50	96.4	80-120
Calcium	43000	43600	1.4	0-20	43000	68200	25000	100.8	80-120
Chromium									
Cobalt									
Copper	0.0	0.0	NC	0-20	0.0	252	250	100.8	80-120
Iron									
Lead	0.0	0.0	NC	0-20	0.0	458	500	91.6	80-120
Magnesium	1030	1060	2.9	0-20	1030	25000	25000	95.9	80-120
Manganese									
Molybdenum									
Nickel									
Potassium									
Selenium									
Silver									
Sodium	anr								
Strontium									
Thallium									
Tin									
Titanium									
Vanadium									
Zinc	5.4	5.2	3.8	0-20	5.4	495	500	97.9	80-120

Associated samples MP24976: FA3595-1, FA3595-2

Results < IDL are shown as zero for calculation purposes
 (*) Outside of QC limits
 (N) Matrix Spike Rec. outside of QC limits
 (anr) Analyte not requested

6.1.2
 6

MATRIX SPIKE AND DUPLICATE RESULTS SUMMARY

Login Number: FA3595
 Account: BFACFLO - BFA Environmental Consultants
 Project: Orange County Dewatering Screening; FL

QC Batch ID: MP24976
 Matrix Type: AQUEOUS

Methods: SW846 6010C
 Units: ug/l

Prep Date: 04/17/13

Metal	FA3595-1 Original	MSD	Spike/lot MPFLICP1	% Rec	MSD RPD	QC Limit
Aluminum						
Antimony						
Arsenic	anr					
Barium						
Beryllium						
Cadmium	0.0	47.6	50	95.2	1.3	20
Calcium	43000	66300	25000	93.2	2.8	20
Chromium						
Cobalt						
Copper	0.0	251	250	100.4	0.4	20
Iron						
Lead	0.0	446	500	89.2	2.7	20
Magnesium	1030	24700	25000	94.7	1.2	20
Manganese						
Molybdenum						
Nickel						
Potassium						
Selenium						
Silver						
Sodium	anr					
Strontium						
Thallium						
Tin						
Titanium						
Vanadium						
Zinc	5.4	485	500	95.9	2.0	20

Associated samples MP24976: FA3595-1, FA3595-2

Results < IDL are shown as zero for calculation purposes
 (*) Outside of QC limits
 (N) Matrix Spike Rec. outside of QC limits
 (anr) Analyte not requested

6.1.2
 6

SPIKE BLANK AND LAB CONTROL SAMPLE SUMMARY

Login Number: FA3595
 Account: BFACFLO - BFA Environmental Consultants
 Project: Orange County Dewatering Screening; FL

QC Batch ID: MP24976
 Matrix Type: AQUEOUS

Methods: SW846 6010C
 Units: ug/l

Prep Date: 04/17/13

Metal	BSP Result	Spikelot MPFLICP1	% Rec	QC Limits
Aluminum				
Antimony				
Arsenic	anr			
Barium				
Beryllium				
Cadmium	49.2	50	98.4	80-120
Calcium	24900	25000	99.6	80-120
Chromium				
Cobalt				
Copper	256	250	102.4	80-120
Iron				
Lead	449	500	89.8	80-120
Magnesium	24500	25000	98.0	80-120
Manganese				
Molybdenum				
Nickel				
Potassium				
Selenium				
Silver				
Sodium	anr			
Strontium				
Thallium				
Tin				
Titanium				
Vanadium				
Zinc	494	500	98.8	80-120

Associated samples MP24976: FA3595-1, FA3595-2

Results < IDL are shown as zero for calculation purposes
 (*) Outside of QC limits
 (anr) Analyte not requested

6.1.3
 6

SERIAL DILUTION RESULTS SUMMARY

Login Number: FA3595
 Account: BFACFLO - BFA Environmental Consultants
 Project: Orange County Dewatering Screening; FL

QC Batch ID: MP24976
 Matrix Type: AQUEOUS

Methods: SW846 6010C
 Units: ug/l

Prep Date: 04/17/13

Metal	FA3595-1 Original	SDL 1:5	%DIF	QC Limits
Aluminum				
Antimony				
Arsenic	anr			
Barium				
Beryllium				
Cadmium	0.00	0.00	NC	0-10
Calcium	43000	44100	2.6	0-10
Chromium				
Cobalt				
Copper	0.00	0.00	NC	0-10
Iron				
Lead	0.00	0.00	NC	0-10
Magnesium	1030	1080	5.1	0-10
Manganese				
Molybdenum				
Nickel				
Potassium				
Selenium				
Silver				
Sodium	anr			
Strontium				
Thallium				
Tin				
Titanium				
Vanadium				
Zinc	5.40	0.00	100.0(a)	0-10

Associated samples MP24976: FA3595-1, FA3595-2

Results < IDL are shown as zero for calculation purposes

(*) Outside of QC limits

(anr) Analyte not requested

(a) Percent difference acceptable due to low initial sample concentration (< 50 times IDL).

POST DIGESTATE SPIKE SUMMARY

Login Number: FA3595
 Account: BFACFLO - BFA Environmental Consultants
 Project: Orange County Dewatering Screening; FL

QC Batch ID: MP24976
 Matrix Type: AQUEOUS

Methods: SW846 6010C
 Units: ug/l

Prep Date:

04/17/13

Metal	Sample ml	Final ml	FA3595-1 Raw	FA3595-1 Corr.**	PS ug/l	Spike ml	Spike ug/ml	Spike ug/l	% Rec	QC Limits
Aluminum										
Antimony										
Arsenic										
Barium										
Beryllium										
Cadmium	9.8	10	0	0	49.8	0.2	2.5	50	99.6	80-120
Calcium	9.8	10	43000	42140	47770	0.2	250	5000	112.6	80-120
Chromium										
Cobalt										
Copper	9.8	10	0	0	101.6	0.2	5	100	101.6	80-120
Iron										
Lead	9.8	10	0	0	43.7	0.2	2.5	50	87.4	80-120
Magnesium	9.8	10	1029	1008.42	5792	0.2	250	5000	95.7	80-120
Manganese										
Molybdenum										
Nickel										
Potassium										
Selenium										
Silver										
Sodium										
Strontium										
Thallium										
Tin										
Titanium										
Vanadium										
Zinc	9.8	10	5.4	5.292	293.5	0.2	12.5	250	115.3	80-120

Associated samples MP24976: FA3595-1, FA3595-2

Results < IDL are shown as zero for calculation purposes
 (*) Outside of QC limits
 (**) Corr. sample result = Raw * (sample volume / final volume)
 (anr) Analyte not requested

General Chemistry

QC Data Summaries

Includes the following where applicable:

- Method Blank and Blank Spike Summaries
- Duplicate Summaries
- Matrix Spike Summaries

METHOD BLANK AND SPIKE RESULTS SUMMARY
GENERAL CHEMISTRY

Login Number: FA3595
Account: BFACFLO - BFA Environmental Consultants
Project: Orange County Dewatering Screening; FL

Analyte	Batch ID	RL	MB Result	Units	Spike Amount	BSP Result	BSP %Recov	QC Limits
Chromium, Hexavalent	GN55207	0.010	0.0	mg/l	0.100	0.11	104.5	78-120%
Total Organic Carbon	GP21470/GN55275	1.0	0.0	mg/l	15	15.3	102.0	90-110%

Associated Samples:

Batch GN55207: FA3595-1, FA3595-2

Batch GP21470: FA3595-1, FA3595-2

(*) Outside of QC limits

DUPLICATE RESULTS SUMMARY
GENERAL CHEMISTRY

Login Number: FA3595
Account: BFACFLO - BFA Environmental Consultants
Project: Orange County Dewatering Screening; FL

Analyte	Batch ID	QC Sample	Units	Original Result	DUP Result	RPD	QC Limits
Total Organic Carbon	GP21470/GN55275	FA3598-1F	mg/l	41.8	42.6	1.9	0-20%
pH	GN55209	FA3595-1	su	7.38	7.34	0.5	0-10%

Associated Samples:

Batch GN55209: FA3595-1, FA3595-2

Batch GP21470: FA3595-1, FA3595-2

(*) Outside of QC limits

MATRIX SPIKE RESULTS SUMMARY
GENERAL CHEMISTRY

Login Number: FA3595
Account: BFACFLO - BFA Environmental Consultants
Project: Orange County Dewatering Screening; FL

Analyte	Batch ID	QC Sample	Units	Original Result	Spike Amount	MS Result	%Rec	QC Limits
Chromium, Hexavalent	GN55207	FA3595-2	mg/l	0.0080 U	0.100	0.054	54.4*(a)	78-120%
Total Organic Carbon	GP21470/GN55275	FA3598-1F	mg/l	41.8	15	51.6	65.3N(a)	90-110%

Associated Samples:

Batch GN55207: FA3595-1, FA3595-2

Batch GP21470: FA3595-1, FA3595-2

(*) Outside of QC limits

(N) Matrix Spike Rec. outside of QC limits

(a) Spike recovery indicates possible matrix interference.

7.3

7

MATRIX SPIKE DUPLICATE RESULTS SUMMARY
GENERAL CHEMISTRY

Login Number: FA3595
Account: BFACFLO - BFA Environmental Consultants
Project: Orange County Dewatering Screening; FL

Analyte	Batch ID	QC Sample	Units	Original Result	Spike Amount	MSD Result	RPD	QC Limit
Chromium, Hexavalent	GN55207	FA3595-2	mg/l	0.0080 U	0.100	0.0550	2.0	34%

Associated Samples:

Batch GN55207: FA3595-1, FA3595-2

(*) Outside of QC limits

(N) Matrix Spike Rec. outside of QC limits

Misc. Forms

Custody Documents and Other Forms

(Accutest New Jersey)

Includes the following where applicable:

- Chain of Custody

Accutest Laboratories Sample Receipt Summary

Accutest Job Number: FA3595 **Client:** _____ **Project:** _____
Date / Time Received: 4/16/2013 **Delivery Method:** _____ **Airbill #s:** _____

Cooler Temps (Initial/Adjusted): #1: (4/4); 0

<u>Cooler Security</u>	<u>Y or N</u>		<u>Y or N</u>
1. Custody Seals Present:	<input checked="" type="checkbox"/> <input type="checkbox"/>	3. COC Present:	<input checked="" type="checkbox"/> <input type="checkbox"/>
2. Custody Seals Intact:	<input checked="" type="checkbox"/> <input type="checkbox"/>	4. Smpl Dates/Time OK	<input checked="" type="checkbox"/> <input type="checkbox"/>

<u>Cooler Temperature</u>	<u>Y or N</u>
1. Temp criteria achieved:	<input checked="" type="checkbox"/> <input type="checkbox"/>
2. Cooler temp verification:	Bar Therm
3. Cooler media:	Ice (Bag)
4. No. Coolers:	1

<u>Quality Control Preservation</u>	<u>Y</u>	<u>or</u>	<u>N</u>	<u>N/A</u>
1. Trip Blank present / cooler:	<input type="checkbox"/>	<input checked="" type="checkbox"/>	<input type="checkbox"/>	<input type="checkbox"/>
2. Trip Blank listed on COC:	<input type="checkbox"/>	<input checked="" type="checkbox"/>	<input type="checkbox"/>	<input type="checkbox"/>
3. Samples preserved properly:	<input checked="" type="checkbox"/>	<input type="checkbox"/>	<input type="checkbox"/>	<input type="checkbox"/>
4. VOCs headspace free:	<input type="checkbox"/>	<input type="checkbox"/>	<input type="checkbox"/>	<input checked="" type="checkbox"/>

<u>Sample Integrity - Documentation</u>	<u>Y</u>	<u>or</u>	<u>N</u>
1. Sample labels present on bottles:	<input checked="" type="checkbox"/>	<input type="checkbox"/>	<input type="checkbox"/>
2. Container labeling complete:	<input checked="" type="checkbox"/>	<input type="checkbox"/>	<input type="checkbox"/>
3. Sample container label / COC agree:	<input checked="" type="checkbox"/>	<input type="checkbox"/>	<input type="checkbox"/>

<u>Sample Integrity - Condition</u>	<u>Y</u>	<u>or</u>	<u>N</u>
1. Sample recvd within HT:	<input checked="" type="checkbox"/>	<input type="checkbox"/>	<input type="checkbox"/>
2. All containers accounted for:	<input checked="" type="checkbox"/>	<input type="checkbox"/>	<input type="checkbox"/>
3. Condition of sample:	Intact		

<u>Sample Integrity - Instructions</u>	<u>Y</u>	<u>or</u>	<u>N</u>	<u>N/A</u>
1. Analysis requested is clear:	<input checked="" type="checkbox"/>	<input type="checkbox"/>	<input type="checkbox"/>	<input type="checkbox"/>
2. Bottles received for unspecified tests	<input type="checkbox"/>	<input type="checkbox"/>	<input checked="" type="checkbox"/>	<input type="checkbox"/>
3. Sufficient volume recvd for analysis:	<input checked="" type="checkbox"/>	<input type="checkbox"/>	<input type="checkbox"/>	<input type="checkbox"/>
4. Compositing instructions clear:	<input type="checkbox"/>	<input type="checkbox"/>	<input type="checkbox"/>	<input checked="" type="checkbox"/>
5. Filtering instructions clear:	<input type="checkbox"/>	<input type="checkbox"/>	<input type="checkbox"/>	<input checked="" type="checkbox"/>

Comments

Metals Analysis

QC Data Summaries

(Accutest New Jersey)

Includes the following where applicable:

- Method Blank Summaries
- Matrix Spike and Duplicate Summaries
- Blank Spike and Lab Control Sample Summaries
- Serial Dilution Summaries

BLANK RESULTS SUMMARY
Part 2 - Method Blanks

Login Number: FA3595

Account: ALSE - Accutest Laboratories Southeast, Inc.
Project: BFACFLO: Orange County Dewatering Screening; FL

QC Batch ID: MP71479
Matrix Type: AQUEOUS

Methods: EPA 1631
Units: ng/l

Prep Date: 04/17/13

Metal	RL	IDL	MDL	MB raw	final
Mercury	0.50	.086	.28	-0.052	<0.50

Associated samples MP71479: FA3595-1, FA3595-2

Results < IDL are shown as zero for calculation purposes
(*) Outside of QC limits
(anr) Analyte not requested

MATRIX SPIKE AND DUPLICATE RESULTS SUMMARY

Login Number: FA3595
 Account: ALSE - Accutest Laboratories Southeast, Inc.
 Project: BFACFLO: Orange County Dewatering Screening; FL

QC Batch ID: MP71479
 Matrix Type: AQUEOUS

Methods: EPA 1631
 Units: ng/l

Prep Date: 04/20/13

Metal	FA3595-2 Original MS	Spikelot HGLL1	% Rec	QC Limits
Mercury	14.0	21.3	5	146.0N(a) 71-125

Associated samples MP71479: FA3595-1, FA3595-2

Results < IDL are shown as zero for calculation purposes
 (*) Outside of QC limits
 (N) Matrix Spike Rec. outside of QC limits
 (anr) Analyte not requested
 (a) Spike recovery indicates possible matrix interference.

MATRIX SPIKE AND DUPLICATE RESULTS SUMMARY

Login Number: FA3595
 Account: ALSE - Accutest Laboratories Southeast, Inc.
 Project: BFACFLO: Orange County Dewatering Screening; FL

QC Batch ID: MP71479
 Matrix Type: AQUEOUS

Methods: EPA 1631
 Units: ng/l

Prep Date: 04/20/13

Metal	FA3595-2 Original	MSD	Spike/lot HGLL1	% Rec	MSD RPD	QC Limit
Mercury	14.0	20.1	5	122.0	5.8	24

Associated samples MP71479: FA3595-1, FA3595-2

Results < IDL are shown as zero for calculation purposes
 (*) Outside of QC limits
 (N) Matrix Spike Rec. outside of QC limits
 (anr) Analyte not requested

SPIKE BLANK AND LAB CONTROL SAMPLE SUMMARY

Login Number: FA3595

Account: ALSE - Accutest Laboratories Southeast, Inc.
Project: BFACFLO: Orange County Dewatering Screening; FL

QC Batch ID: MP71479
Matrix Type: AQUEOUS

Methods: EPA 1631
Units: ng/l

Prep Date: 04/18/13

Metal	LCS Result	Spikelot HGLL1	% Rec	QC Limits
Mercury	5.4	5	108.0	77-123

Associated samples MP71479: FA3595-1, FA3595-2

Results < IDL are shown as zero for calculation purposes
(*) Outside of QC limits
(anr) Analyte not requested

APPENDIX B

ORANGE COUNTY UTILITIES

FORMS

- **Digital Data Submission**
- **Pressure Test**
- **Pump Station Start-up**

APPENDIX B

FORMS

Digital Data Submission

February 11, 2011

This form is to be utilized for the submittal of digital data in accordance with the requirements outlined in Chapter 2111, "Project Documents and Submittals".

Date of Submittal: _____

Project Number: _____

Project Name: _____

Project Manager: _____

Consulting Firm: _____

Address: _____

City: _____ State: _____ Zip: _____

Phone: _____ Email: _____

Type of Submittal: Construction Plans Record Drawings

File Format: _____

APPENDIX B

FORMS

Pressure Test

February 11, 2011

Project Name: _____						<input type="checkbox"/> Force Main <input type="checkbox"/> Reclaimed Main <input type="checkbox"/> Water Main		Allowable Loss – 2 Hours $L = \frac{SD(P)}{1/2}$ 148,000 <i>See Note Below</i>										
Constructed by: _____																		
DATE	LINE SEGMENT	STATION		LENGTH	N	D	START		END		LOSS (gal)		Pass /Fail STATUS					
		From	To				Time	PSI	Time	PSI	Allow	Actual						
COUNTY Inspector's Name:						Signature:						Date:						
Tester's Name:						Signature:						Date:						
Comments:																		

Note: L - Allowable leakage in gallons per hour.
 S - Length of pipe tested, in feet.
 D - Nominal diameter of the pipe in inches.
 P - Average test pressure during leakage test in pounds per square inch gauge.

APPENDIX C

ORANGE COUNTY UTILITIES

PERMITS OBTAINED BY COUNTY

- **FDEP Permit PS #3365 (University at Rouse) – Included**
- **FDEP Permit PS #3309 (Lena Street) – Not Required**
- **FDEP Permit PS #3893 (Allison Oaks) – Included**
- **FDEP Permit PS #3887 (Greenview Pines) – Included**
- **FDEP Permit PS #3890 (Bradford Cove) – Not Required**



FLORIDA DEPARTMENT OF ENVIRONMENTAL PROTECTION

Central District
3319 Maguire Boulevard, Suite 232
Orlando, Florida 32803-3767

RICK SCOTT
GOVERNOR

JENNIFER CARROLL
LT. GOVERNOR

HERSCHEL T. VINYARD JR.
SECRETARY

NOTICE OF PERMIT ISSUANCE

Sent via email: jim.broome@ocfl.net

In the Matter of an
Application for Permit by:

ORANGE COUNTY UTILITIES DEPARTMENT
9150 CURRY FORD ROAD
2ND FLOOR
ORLANDO FL 32825

ATTENTION JAMES N BROOME PE
CHIEF ENGINEER

Orange County - CS
Allison Oaks (PS #3893A) and Greenview Pines (PS#3887)
Connected to: OCUD/Eastern WRF - FL0038849

Dear Mr. Broome:

Enclosed is Permit Number CS48-0316825-001 to construct a sewage collection/transmission system, issued pursuant to 403.087(1), Florida Statutes.

The Department's proposed agency action shall become final unless a timely petition for an administrative hearing is filed under Sections 120.569 and 120.57, Florida Statutes, within fourteen days of receipt of notice. The procedures for petitioning for a hearing are set forth below.

A person whose substantial interests are affected by the Department's proposed permitting decision may petition for an administrative proceeding (hearing) under Sections 120.569 and 120.57, Florida Statutes. The petition must contain the information set forth below and must be filed (received by the clerk) in the Office of General Counsel of the Department at 3900 Commonwealth Boulevard, Mail Station 35, Tallahassee, Florida 32399-3000.

Petitions by the applicant or any of the persons listed below must be filed within fourteen days of receipt of this written notice. Petitions filed by any persons other than those entitled to written notice under Section 120.60(3), Florida Statutes, must be filed within fourteen days of publication of the notice or within fourteen days of receipt of the written notice, whichever occurs first. Under Section 120.60(3), Florida Statutes, however, any person who has asked the Department for notice of agency action may file a petition within fourteen days of receipt of such notice, regardless of the date of publication.

The petitioner shall mail a copy of the petition to the applicant at the address indicated above at the time of filing. The failure of any person to file a petition within fourteen days of receipt of notice shall constitute a waiver of that person's right to request an administrative determination (hearing) under Sections 120.569 and 120.57, Florida Statutes. Any subsequent intervention (in a proceeding initiated by another party) will be only at the discretion of the presiding officer upon the filing of a motion in compliance with Rule 28-106.205, Florida Administrative Code.

A petition that disputes the material facts on which the Department's action is based must contain the following information:

- (a) The name, address, and telephone number of each petitioner; the name, address, and telephone number of the petitioner's representative, if any; the Department permit identification number and the county in which the subject matter or activity is located;
- (b) A statement of how and when each petitioner received notice of the Department action;
- (c) A statement of how each petitioner's substantial interests are affected by the Department action;
- (d) A statement of all disputed issues of material fact. If there are none, the petition must so indicate;
- (e) A statement of facts that the petitioner contends warrant reversal or modification of the Department action;
- (f) A concise statement of the ultimate facts alleged, as well as the rules and statutes which entitle the petitioner to relief; and
- (g) A statement of the relief sought by the petitioner, stating precisely the action that the petitioner wants the Department to take.

Because the administrative hearing process is designed to formulate final agency action, the filing of a petition means that the Department's final action may be different from the position taken by it in this notice. Persons whose substantial interests will be affected by any such final decision of the Department have the right to petition to become a party to the proceeding, in accordance with the requirements set forth above.

Mediation under Section 120.573, Florida Statutes, is not available for this proceeding.

This permit action is final and effective on the date filed with the clerk of the Department unless a petition is filed in accordance with the above. Upon the timely filing of a petition this permit will not be effective until further order of the Department.

Any party to the permit has the right to seek judicial review of the permit action under Section 120.68, Florida Statutes, by the filing of a notice of appeal under Rules 9.110 and 9.190, Florida Rules of Appellate Procedure, with the clerk of the Department in the Office of General Counsel, Mail Station 35, 3900 Commonwealth Boulevard, Tallahassee, Florida, 32399-3000; and by filing a copy of the notice of appeal accompanied by the applicable filing fees with the appropriate district court of appeal. The notice of appeal must be filed within 30 days from the date when this permit action is filed with the clerk of the Department.



**FLORIDA DEPARTMENT OF
ENVIRONMENTAL PROTECTION**

Central District
3319 Maguire Boulevard, Suite 232
Orlando, Florida 32803-3767

RICK SCOTT
GOVERNOR

JENNIFER CARROLL
LT. GOVERNOR

HERSCHEL T. VINYARD JR.
SECRETARY

**STATE OF FLORIDA
DOMESTIC WASTEWATER COLLECTION/TRANSMISSION INDIVIDUAL PERMIT**

Permittee:
ORANGE COUNTY UTILITIES DEPARTMENT
9150 CURRY FORD ROAD
2ND FLOOR
ORLANDO FL 32825
Attention: James N Broome, P.E.
Chief Engineer

Permit Number: CS48-0316825-001
Date of Issue: March 13, 2013
Expiration Date: March 12, 2018
County: Orange
Project: Allison Oaks (PS #3893A) and
Greenview Pines (PS#3887)
Connected to: OCUD/Eastern WRF -
FL0038849

This permit is issued under the provisions of Chapter 403, Florida Statutes (F.S.), and Chapters 62-4 and 62-604, Florida Administrative Code (F.A.C.).

The above named permittee is hereby authorized to construct the facilities shown on the application and other documents on file with the Department and made a part hereof and specifically described as follows:

DESCRIPTION OF PROJECT:

Construction of a sewage collection/transmission system for the Allison Oaks (PS #3893A) and Greenview Pines (PS#3887) project to serve existing development generating no new flows.

The sewage collection/transmission system shall consist of: (A) 296 LF of 8 inch PVC gravity mains, (B) 90 LF of 4 inch PVC force mains, (C) one lift station with two submersible pumps operating at 100 gpm, (D) second rehabilitated lift station with two new submersibles pumps operating at 100 gpm, and (E) associated manholes, valves and other appurtenances .

LOCATION OF PROJECT: 3120 Patel Drive and 3695 Greenview Pines Court respectively, Winter Park, Orange County, Florida.

IN ACCORDANCE WITH: The limitations, requirements and other conditions set forth in pages 1 through 3 of this permit.

Permittee:
ORANGE COUNTY UTILITIES DEPARTMENT

Permit Number: CS48-0316825-001
Expiration Date: March 12, 2018

Attention: James N Broome, P.E.
Chief Engineer

PERMIT CONDITIONS:

1. This permit is subject to the general conditions of Rule 62-4.160, F.A.C., as applicable. This rule is available at the Department's Internet site at:
<http://www.dep.state.fl.us/water/wastewater/rules.htm#domestic> [62-4.160]
2. Upon completion of construction of the collection/transmission system project, and before placing the facilities into operation for any purpose other than testing for leaks or testing equipment operation, the permittee shall submit to the Department's Central District Office Form 62-604.300(8)(b), Request for Approval to Place a Domestic Wastewater Collection/Transmission System into Operation. This form is available at the Department's Internet site at:
<http://www.dep.state.fl.us/water/wastewater/forms.htm> [62-604.700(2), 11-6-03]
3. The new or modified collection/transmission facilities shall not be placed into service until the Department clears the project for use. [62-604.700(3), 11-6-03]
4. Permit revisions shall only be made in accordance with Rule 62-4.050(4)(s), F.A.C. Request for revisions shall be made to the Department in writing and shall include the appropriate fee. Revisions not covered under Rule 62-4.050(4)(s), F.A.C., shall require a new permit. [62-604.600(8), 11-6-03]
5. Abnormal events shall be reported to the Department's Central District office in accordance with Rule 62-604.550, F.A.C. For unauthorized spills of wastewater in excess of 1000 gallons per incident, or where information indicates that public health or the environment may be endangered, oral reports shall be provided to the STATE WARNING POINT TOLL FREE NUMBER, (800) 320-0519, as soon as practical, but no later than 24 hours from the time the permittee or other designee becomes aware of the circumstances. Unauthorized releases or spills less than 1000 gallons per incident are to be reported orally to the Department's Central District office within 24 hours from the time the permittee, or other designee becomes aware of the circumstances. [62-604.550, 11-6-03]
6. The permittee shall be responsible for proper operation and maintenance of the pump station, including clean-up of spills resultant from pump station malfunction and providing temporary service power generating and pumping equipment for emergency situations. In the event of equipment breakdown, power outages, destruction by hazard of fire, wind or by other cause, the permittee shall notify the Department, within 24 hours when such abnormal events result in the disposal of inadequately treated waste in violation of DEP Rule 62-604.130(1), F.A.C. in accordance with DEP Rule 62-604.550, F.A.C.

Permittee:
ORANGE COUNTY UTILITIES DEPARTMENT

Permit Number: CS48-0316825-001
Expiration Date: March 11, 2018

Attention: James N Broome, P.E.
Chief Engineer

Executed in Orlando, Florida.

STATE OF FLORIDA DEPARTMENT
OF ENVIRONMENTAL PROTECTION

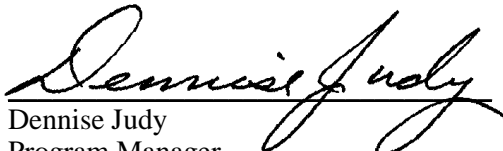
Dennise Judy
Program Manager
Domestic Waste Permitting

FILING AND ACKNOWLEDGEMENT

Filed, on this date, pursuant to Section 120.52, F.S., with the designated Department Clerk, receipt of which is hereby acknowledged.

Clerk March 13, 2013
Date

DJ/mcc/al/ply

Copies furnished to:
Heriberto Collado-Lopez (via email: heriberto.collado.ocfl.net)
Robert Murphy (via email: robert.murphy@ocfl.net)
Jeff Nazario (via email: Jeffrey.Nazario@ocfl.net)

CERTIFICATE OF SERVICE

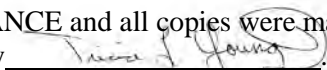
This is to certify that this NOTICE OF PERMIT ISSUANCE and all copies were mailed before the close of business on March 13, 2013 to the listed persons, by 



**FLORIDA DEPARTMENT OF
ENVIRONMENTAL PROTECTION**
CENTRAL DISTRICT
3319 MAGUIRE BOULEVARD, SUITE 232
ORLANDO, FLORIDA 32803

RICK SCOTT
GOVERNOR

CARLOS LOPEZ-CANTERA
LT. GOVERNOR

HERSCHEL T. VINYARD JR.
SECRETARY

PERMITTEE:
JAMES BROOME, CHIEF ENGINEER
ORANGE COUNTY UTILITIES
9150 CURRY FORD ROAD
ORLANDO, FL 32825
Jim.broome@ocfl.net

PERMIT NUMBER: 0327334-001
COUNTY: Orange
PROJECT: Rouse / University PS 3365
Rehabilitation
GENERATING: Zero GPD
CONNECTED TO: OCUD Eastern WRF
(FL0038849)

Dear Mr. Broome:

This letter acknowledges receipt of your Notification/Application for Constructing a Domestic Wastewater Collection/Transmission System for the subject project. Our office received the Notice on June 23, 2014.

This is to advise you that the Department does not object to your use of such General Permit.

Please note the attached requirements apply to your use of this General Permit for constructing the proposed domestic wastewater collection/transmission system. In accordance with Rule 62-4.540(13), F.A.C., this authorization shall be good for a period of five years from the date of this letter.

You are further advised that the construction activity must conform to the description contained in your Notification/Application for Constructing a Domestic Wastewater Collection/Transmission System and that any deviation will subject the permittee to enforcement action and possible penalties.

Sincerely,

Charles LeGros
Engineer
Wastewater Permitting

Date: July 2, 2014

CRL/ohm

cc: Geoff Hennessey, PE, Barnes Ferland and Assoc (via email: gghennessey@bfaenvironmental.com)
Willard Hoanshelt, PE, EMI Consulting Specialties, Inc (via email: whoanshelt@emicfl.com)

REQUIREMENTS FOR USE OF THE GENERAL PERMIT FOR DOMESTIC WASTEWATER COLLECTION/TRANSMISSION SYSTEMS:

1. This general permit is subject to the general permit conditions of Rule 62-4.050, F.A.C., as applicable. This rule is available at the Department's Internet site at: <http://www.dep.state.fl.us/water/wastewater/rules.htm#domestic> [62-4.050]
2. This general permit does not relieve the permittee of the responsibility for obtaining a dredge and fill permit where it is required. [62-604.600(6)(b)1, 11-6-03]
3. This general permit cannot be revised, except to transfer the permit. [62-604.600(6)(b)2, 11-6-03]
4. Upon completion of construction of the collection/transmission system project, and before placing the facilities into operation for any purpose other than testing for leaks or testing equipment operation, the permittee shall submit to the Department's Central District Office, Form 62-604.300(8)(b), Request for Approval to Place a Domestic Wastewater Collection/Transmission System into Operation. This form is available at the Department's Internet site at: <http://www.dep.state.fl.us/water/wastewater/forms.htm> [62-604.700(2), 11-6-03]
5. The new or modified collection/transmission facilities shall not be placed into service until the Department clears the project for use. [62-604.700(3), 11-6-03]
6. Abnormal events shall be reported to the Department's Central District Office in accordance with Rule 62-604.550, F.A.C. For unauthorized spills of wastewater in excess of 1000 gallons per incident, or where information indicates that public health or the environment may be endangered, oral reports shall be provided to the STATE WARNING POINT TOLL FREE NUMBER (800) 320-0519 as soon as practical, but no later than 24 hours from the time the permittee or other designee becomes aware of the circumstances. Unauthorized releases or spills less than 1000 gallons per incident are to be reported orally to the Department's Central District Office within 24 hours from the time the permittee, or other designee becomes aware of the circumstances. [62-604.550, 11-6-03]

APPENDIX D

ORANGE COUNTY UTILITIES Standards and Construction Specification Manual

LIST OF APPROVED PRODUCTS

APPENDIX D

LIST OF APPROVED PRODUCTS - TRANSMISSION SYSTEMS

FEBRUARY 11, 2011

Cat.	Desc	Manufacturer	Water		Reclaimed Water		Wastewater	
			Model #	Comments	Model #	Comments	Model #	Comments
Air Release	ARV Enclosure	All ARV above ground enclosures shall be vented with tamper proof locking device						
		Water Plus Polyethylene Enclosure	131632 H30-B	Blue 44" Tall	131632 H30-P	Pantone 44"	131632 H30-G	Green 44" Tall
			171730 H40-B	Blue 30" Tall	171730 H40-P	Pantone 30"	171730 H40-G	Green 30" Tall
		Hot Box Vent Guard Fiberglass Enclosure	AVG2036 Encl	Blue 36" Tall	AVG2036 Encl	Pantone 36" Tall	AVG2036 Encl	Green 36" Tall
			GP3232 Base		GP3232 Base		GP3232 Base	
			AVG2041 Encl	Blue 41" Tall	AVG2041 Encl	Pantone 41" Tall	AVG2041 Encl	Green 41" Tall
		GP3232 Base		GP3232 Base		GP3232 Base		
	Safety-Guard/Hydro Guard	15100 Encl	Blue 34" Tall	15100 Encl	Pantone 34" Tall	15100 Encl	Green 34" Tall	
	Air Release Valves	Air Release Valves shall be Combination Type, 316 SS						
		ARI	D-040SS	Combination	D-040SS	Combination	D-020 (SS)	Combination
H-TEC		NA	NA	NA	NA	986 (316SS)	Combination	
Vent-O-Mat		Series RBX DN50	2"	Series RBX DN50	2"	RGX series		
ARV Vault	Air Release Valve Frame and Cover							
	US Foundry	NA	NA	NA	NA	USF 7665-HH-HJ		
Blow Off	Auto Blow Off	Automatic Blow Off Valve						
		Hydro Guard	HG-1 Standard Unit	Automatic	NA	NA	NA	NA
	Blow Off Valve	Blow Off Valve - Fits standard 5-1/4 inch Valve Box						
		Kupferle Foundry Co	Truflo Series TF #550		Truflo Series TF #550		NA	NA
	Water Plus Corp	The Hydrant Plus Series VB 2000B		The Hydrant Plus Series VB 2000B		NA	NA	
Casing Seals / Spacers	Casing End Seals	Casing End Seals. Annular space between pipe and steel casing shall be brick and mortar with end seals to secure ends.						
		Advance Products	Model AC and AW		Model AC and AW		Model AC and AW	
		BWM Company	Model WR and PO		Model WR and PO		Model WR and PO	
		Cascade Water Works	Model CCES		Model CCES		Model CCES	
		CCI Pipeline	Model ESW and ESC		Model ESW and ESC		Model ESW and ESC	
		Pipeline Seal & Insulator, Inc (PSI)	Model C and W		Model C and W		Model C and W	
		Power Seal	Model 4810ES		Model 4810ES		Model 4810ES	

Cat.	Desc	Manufacturer	Water		Reclaimed Water		Wastewater	
			Model #	Comments	Model #	Comments	Model #	Comments
Casing Seals / Spacers	Casing spacer	Casing spacers shall be a min. 8-inches wide for pipe 12" Dia or less or min. 12-inches wide for pipe 16 or greater , shall have a minimum 14 gauge 304 stainless steel shell/band, minimum 10 gauge 304 reinforced risers; minimum thickness of 0.090 EPDM or PVC interior liners, glass reinforces polymer or ultra high molecular weight polyethylene and 304 stainless bolts, nuts and washers.						
		Advance Products	SSI8 / SSI12		SSI8 / SSI12		SSI8 / SSI12	
		BWM Company	BWM-SS-8 / SS-12		BWM-SS-8 / SS-12		BWM-SS-8 / SS-12	
		Cascade Water Works	Series CCS 8" / 12"		Series CCS 8" / 12"		Series CCS 8" / 12"	
		CCI Pipeline	Model CCS8 / CSS12		Model CCS8 / CSS12		Model CCS8 / CSS12	
		Pipeline Seal & Insulator, Inc (PSI)	Series S8G-2 / S12G-2		Series S8G-2 / S12G-2		Series S8G-2 / S12G-2	
Coatings	Exterior Coatings for Exposed Metal Assets	Coatings: Aerial pipe, hydrants, above ground piping, fittings, valves and Appurtenances - System 1 Zinc / Urethane / Fluoropolymer application and color code per Section 3119 Coatings & Linings. Coating shall not be in contact with Potable water unless NSF 61 approved.						
		Carboline	Carbozinc 621	3.0 - 8.0 mils	Carbozinc 621	3.0 - 8.0 mils	Carbozinc 621	3.0 - 8.0 mils
			Carbothane 133 HB	3.0 -5.0 mils	Carbothane 133 HB	3.0 -5.0 mils	Carbothane 133 HB	3.0 -5.0 mils
			Carboxane 950	2.0 - 3.0 mils	Carboxane 950	2.0 - 3.0 mils	Carboxane 950	2.0 - 3.0 mils
		Tnemec	Zinc Series 90-97	2.5 - 3.5 mils	Zinc Series 90-97	2.5 - 3.5 mils	Zinc Series 90-97	2.5 - 3.5 mils
			Typoxy Series 27WB	4.0 -14.0 mils	Typoxy Series 27WB	4.0 -14.0 mils	Typoxy Series 27WB	4.0 -14.0 mils
			EnduraShield Series73	2.0 - 3.0 mils	EnduraShield Series73	2.0 - 3.0 mils	EnduraShield Series73	2.0 - 3.0 mils
	Hydroflon Series 700		2.0 - 3.0 mils	Hydroflon Series 700	2.0 - 3.0 mils	Hydroflon Series 700	2.0 - 3.0 mils	
	Exterior Coatings for Exposed Metal Assets	Coatings: Aerial pipe, hydrants, above ground piping, fittings, valves and Appurtenances - System 2 Zinc / Epoxy / Urethane application and color code per Section 3119 Coatings & Linings. Coating shall not be in contact with Potable water unless NSF 61 approved.						
		Carboline	Carbozinc 621	3.0 - 8.0 mils	Carbozinc 621	3.0 - 8.0 mils	Carbozinc 621	3.0 - 8.0 mils
			Carboguard 60	4.0 -6.0 mils	Carboguard 60	4.0 -6.0 mils	Carboguard 60	4.0 -6.0 mils
			Carboxane 950	2.0 - 3.0 mils	Carboxane 950	2.0 - 3.0 mils	Carboxane 950	2.0 - 3.0 mils
		Tnemec	Zinc Series 90-97	2.5 - 3.5 mils	Zinc Series 90-97	2.5 - 3.5 mils	Zinc Series 90-97	2.5 - 3.5 mils
			Typoxy Series 27WB	4.0 -14.0 mils	Typoxy Series 27WB	4.0 -14.0 mils	Typoxy Series 27WB	4.0 -14.0 mils
Hi-Build Epoxoline II Series N69			4.0 - 10.0 mils	Hi-Build Epoxoline II Series N69	4.0 - 10.0 mils	Hi-Build Epoxoline II Series N69	4.0 - 10.0 mils	
EnduraShield Series73	2.0 - 3.0 mils		EnduraShield Series73	2.0 - 3.0 mils	EnduraShield Series73	2.0 - 3.0 mils		
PPG / Ameron	Amercoat 68HS	Min 3.0 mils	Amercoat 68HS	Min 3.0 mils	Amercoat 68HS	Min 3.0 mils		
	Amercoat 385	4.0 - 6.0 mils	Amercoat 385	4.0 - 6.0 mils	Amercoat 385	4.0 - 6.0 mils		
	Amercoat 450H	2.0 - 3.0 mils	Amercoat 450H	2.0 - 3.0 mils	Amercoat 450H	2.0 - 3.0 mils		

APPENDIX D

LIST OF APPROVED PRODUCTS - TRANSMISSION SYSTEMS

FEBRUARY 11, 2011

Cat.	Desc	Manufacturer	Water		Reclaimed Water		Wastewater	
			Model #	Comments	Model #	Comments	Model #	Comments
Fittings	Fittings	Ductile Iron Fittings C153 SSB / C110 FLG: (Water & Reclaimed Water fittings shall cement lined or holiday free fusion bonded epoxy lined) (Wastewater fittings interior shall be Protecto 401 and holiday free)						
		American	30" & up	FBE / Cement	30" & up	FBE / Cement	30" & up	Protecto 401
		Sigma		FBE / Cement		FBE / Cement		Protecto 401
		Star		FBE / Cement		FBE / Cement		Protecto 401
		Tyler Union & Clow		FBE / Cement		FBE / Cement		Protecto 401
Flow Meter	Flow Meter	Flow Meters With Replaceable Sensors						
		EMCO	NA	NA	NA	NA	Unimag 4411E	
Hydrants	Hydrants	Hydrants Shall open left, 1-1/2 Pentagon operating nut, NST hose & pumper thread, rotate 360 degrees, closed drains, epoxy on shoe in & out and 304 SS nuts & bolts below ground.						
		American Flow Control	B-84-B (6 inch)		NA	NA	NA	NA
		Clow	Medallion 2545		NA	NA	NA	NA
		Mueller	Super Centurion 250		NA	NA	NA	NA
Joint Restraints	Ductile iron pipe MJ Restraints	Mechanical Joint Wedge-action Restraining Gland, Epoxy Coated Restrain ductile iron pipe to mechanical joint fittings, pipe and appurtenances.						
		EBAA Iron Inc	Megalug Series 1100		Megalug Series 1100		Megalug Series 1100	
		Ford / Uni-Flange	UFR-1400		UFR-1400		UFR-1400	
		Sigma	OneLok Series SLD/SLDE		OneLok Series SLD/SLDE		OneLok Series SLD/SLDE	
		Smith Blair	Cam Lok Series 111		Cam Lok Series 111		Cam Lok Series 111	
		Star	Star Grip Series 3000		Star Grip Series 3000		Star Grip Series 3000	
		Tyler Union	TufGrip Series TLD		TufGrip Series TLD		TufGrip Series TLD	
	DIP Bell Joint Restraints (4" - 12") (New & Existing)	Bell Joint Restraints for Ductile Iron Pipe (4"-12") (New & Existing) - All restraints split serrated on bell and spigot ends. Pipe 16" and greater shall have restraint gaskets or locking bells. (Wastewater only for restraint of existing DIP FM)						
		EBAA Iron Inc	Tru-Dual Series 1500TD		Tru-Dual Series 1500TD		Tru-Dual Series 1500TD	
		Ford / Uni-Flange	Uni-Flange Series 1390C		Uni-Flange Series 1390C		Uni-Flange Series 1390C	
		Sigma	PV-Lok Series PWP-C		PV-Lok Series PWP-C		PV-Lok Series PWP-C	
		Smith Blair	Bell-Lock Series 165		Bell-Lock Series 165		Bell-Lock Series 165	
		Star	StarGrip Series 3100S		StarGrip Series 3100S		StarGrip Series 3100S	
DIP Bell Joint Restraints (16" & Greater)	Ductile Iron Pipe Bell Joint Restraints for Ductile Iron Pipe (16" & Greater) - All restraints shall have a split back-up ring for the bell and a serrated or wedge action gland for the spigot end. New installation for water & reclaimed water piping 16" and greater shall have restraint gaskets or locking bells.							
	EBAA Iron Inc	Series 1100HD	Existing Only	Series 1100HD	Existing Only	Series 1100HD	Existing Only	
	Sigma	Series SSLDH	Existing Only	Series SSLDH	Existing Only	Series SSLDH	Existing Only	
	Star	Series 3100S	Existing Only	Series 3100S	Existing Only	Series 3100S	Existing Only	

APPENDIX D

LIST OF APPROVED PRODUCTS - TRANSMISSION SYSTEMS

FEBRUARY 11, 2011

Cat.	Desc	Manufacturer	Water		Reclaimed Water		Wastewater	
			Model #	Comments	Model #	Comments	Model #	Comments
Joint Restraints	Ductile iron pipe Bell Joint Restraint Gaskets and Locking Bell (4" & Above)	Bell Joint Restraint Gaskets and Locking Bell (4" & Above) Stainless Steel locking wedges built into the gasket-rubber. ANSI/AWWA C111/A21.11 Standard for Rubber-Gasket Joints for Ductile Iron Pressure Pipe. Ductile Iron Bell Joint Restraint for Push-On Pipe- Locking bell joint system that prevents joint separation and allows for joint deflection. Bells shall be painted red to verify restrained gasket.						
		American	Fast Grip Gasket	Gasket	Fast Grip Gasket	Gasket	NA	NA
			Flex-Ring Joint	Bell Lock	Flex-Ring Joint	Bell Lock	NA	NA
			Lok-Ring Joint	Bell Lock	Lok-Ring Joint	Bell Lock	NA	NA
		Griffin	Talon RJ Gasket	Gasket	Talon RJ Gasket	Gasket	NA	NA
			Snap-Lok	Bell Lock	Snap-Lok	Bell Lock	NA	NA
			McWane Inc. DI Pipe Group	Sure Stop 350 Gasket	Gasket	Sure Stop 350 Gasket	Gasket	NA
		Thrust-Lock		Bell Lock	Thrust-Lock	Bell Lock	NA	NA
		TR-Flex		Bell Lock	TR-Flex	Bell Lock	NA	NA
		Super-Lock		Bell Lock	Super-Lock	Bell Lock	NA	NA
		US Pipe	Field Lok 350 Gasket	Gasket	Field Lok 350 Gasket	Gasket	NA	NA
			Field Lok Gasket	Gasket	Field Lok Gasket	Gasket	NA	NA
			TR-Flex	Bell Lock	TR-Flex	Bell Lock	NA	NA
			HP Lok Restraint Joint	Bell Lock	HP Lok Restraint Joint	Bell Lock	NA	NA
	SS to DIP Transition Restraint	SS to DIP Transition Restraint -Flanged stainless steel pipe from Wetwell to Valve box restrained joint transition (epoxy coated, SS hardware) Flg x PE RJ.						
		EBAA Iron Inc	NA	NA	NA	NA	Megaflange 2100	
		Sigma	NA	NA	NA	NA	SigmaFlange with One Lock SLDE	
	Smith Blair	NA	NA	NA	NA	911 Flange - Lock Restrained FCA		
	PVC Pipe MJ Restraints	Mechanical Joint Wedge-action Restraining Gland, Epoxy Coated Restrain PVC pipe to mechanical joint fittings, and appurtenances.						
		EBAA Iron Inc	Mega-lug Series 2000PV		Mega-lug Series 2000PV		Mega-lug Series 2000PV	
			NA	NA	NA	NA	Megalug Series 2200 (42"-48")	
		Ford / Uni-Flange	UFR 1500 Series		UFR 1500 Series		UFR 1500 Series	
		Sigma	One Lok Series SLC/SLCE		One Lok Series SLC/SLCE		One Lok Series SLC/SLCE	
		Smith Blair	Cam Lok Series 120		Cam Lok Series 120		Cam Lok Series 120	
		Star	Star Grip Series 4000		Star Grip Series 4000		Star Grip Series 4000	
	Tyler Union	TufGrip Series TLP		TufGrip Series TLP		TufGrip Series TLP		
	PVC Bell Joint Restraints (4" - 12") (New & Existing)	PVC Bell Joint Restraints: PVC pipe Split Serrated on Bell End and Spigot End. (4" - 12") (New & Existing)						
		EBAA Iron Inc	Tru-Dual Series 1500TD		Tru-Dual Series 1500TD		Tru-Dual Series 1500TD	
Ford / Uni-Flange		Uni-Flange Series 1390		Uni-Flange Series 1390		Uni-Flange Series 1390		
Sigma		PV-Lok Series PWP		PV-Lok Series PWP		PV-Lok Series PWP		
Smith Blair		Bell-Lock Series 165		Bell-Lock Series 165		Bell-Lock Series 165		
Star		Series 1100C		Series 1100C		Series 1100C		
Tyler Union	TufGrip 300C		TufGrip 300C		TufGrip 300C			

APPENDIX D

LIST OF APPROVED PRODUCTS - TRANSMISSION SYSTEMS

FEBRUARY 11, 2011

Cat.	Desc	Manufacturer	Water		Reclaimed Water		Wastewater	
			Model #	Comments	Model #	Comments	Model #	Comments
Joint Restraints	PVC Bell Joint Restraints (16" & Greater)	PVC Bell Joint Restraints: (16" & Greater) PVC pipe Split Serrated on Bell End and Spigot End. Water & Reclaimed Water Existing pipe only. Wastewater shall be new and existing pipe.						
		Ford / Uni-Flange	Series 1390	Existing Only	Series 1390	Existing Only	Series 1390	
		JCM	Sur-Grip Series 621	Existing Only	Sur-Grip Series 621	Existing Only	Sur-Grip Series 621	
		Sigma	PV-Lok PWP	Existing Only	PV-Lok PWP	Existing Only	PV-Lok PWP	
		Smith Blair	Bell-Lock Series 165	Existing Only	Bell-Lock Series 165	Existing Only	Bell-Lock Series 165	
		Star	Series 1100C	Existing Only	Series 1100C	Existing Only	Series 1100C	
Pipe	PVC C900 DR 18 Bell & Spigot (4" - 12")	C900 Bell & Spigot PVC Pipe: 4 to 12-inch - AWWA C-900, Minimum DR18 for Water, Reclaimed and Wastewater. DR14 for Fire Lines. Manufacturers shall be members in good standing with Uni-Bell to maintain approval status.						
		Certaiteed 4" to 12"	Certa-Lok C900/RJ	Blue	Certa-Lok C900/RJ	Pantone Purple	Certa-Lok C900/RJ	Green
		Diamond Plastics Corp	C-900	Blue	C-900	Pantone Purple	Diamond C900	Green
		Ipex Inc	C-900 Blue Brute	Blue	C-900	Pantone Purple	C900 Blue Brute	Green
		JM Eagle	C-900	Blue	C-900	Pantone Purple	C-900	Green
		National Pipe & Plastics Inc	C-900 Dura- Blue	Blue	C-900	Pantone Purple	C-900 Pipe	Green
		North American Pipe Corp (NAPCO)	C-900	Blue	C-900	Pantone Purple	C-900	Green
		Sanderson Pipe Corp	C-900	Blue	C-900	Pantone Purple	C-900	Green
	PVC C905 DR 18 Bell & Spigot 16" and Larger	C905 Bell & Spigot PVC Pipe 16" and Larger: AWWA C-905, Minimum DR18 for all Force Mains up to 24". Minimum DR21/DR25 for 30" and greater. Manufacturers shall be members in good standing with Uni-Bell to maintain approval status.						
		Certaiteed 16"	NA	NA	NA	NA	Certa-Lok C905/RJ	NA
		Diamond Plastics Corp	NA	NA	NA	NA	Trans-21 DR18	Green
		Ipex Inc	NA	NA	NA	NA	IPEX Centurion	Green
		JM Eagle	NA	NA	NA	NA	C905 Big Blue	Green
National Pipe & Plastics Inc		NA	NA	NA	NA	C905	Green	
HDPE C906 DR11	HDPE Pipe DR11 AWWA C906 shall be Ductile Iron Pipe Size, PE 3408/3608/4710 DIPS manufactured in accordance with ASTM F-714 and listed with NSF. Pipe shall be marked in accordance with either AWWA C901,AWWA C906. Compression type connections are not acceptable in new installations. Pipe joints shall be butt fusion or electro-fusion with flange or adapter. All HDPE shall be color coded to the Utility. Color identifications are in accordance with the APWA/ULCC Uniform Color Code. Manufacturers shall be members in good standing with PPI to maintain approval status.							
	JM Eagle	HDPE	DR11 Blue	HDPE	DR11 Pantone	HDPE	DR11Green	
	Performance Pipe(Chevron)	Driscoplex 4000	DR11 Blue	Driscoplex 4000	DR11 Pantone	Driscoplex 4300	DR11 Green	
	PolyPipe, Inc.	EHMW Poly Pipe	DR11 Blue	EHMW	DR11 Pantone	EHMW	DR11Green	

APPENDIX D

LIST OF APPROVED PRODUCTS - TRANSMISSION SYSTEMS

FEBRUARY 11, 2011

Cat.	Desc	Manufacturer	Water		Reclaimed Water		Wastewater	
			Model #	Comments	Model #	Comments	Model #	Comments
Pipe	Ductile Iron Pipe	Ductile iron/Cast iron: (4" to 12" = Class 350, 16" to 24" - Class 250, 30" to 64" = Class 200). Water and Reclaimed water shall be cement lined. Wastewater Piping shall be Protecto 401 and Holiday Free. Exterior coatings as specified. Wastewater DIP piping shall be for pump station piping only. Manufacturers shall be members in good standing with DIPRA to maintain approval status.						
		American	Cement Lined	Blue	Cement Lined	Pantone Purple	Protecto 401	Pump Station
		Griffin	Cement Lined	Blue	Cement Lined	Pantone Purple	Protecto 401	Pump Station
		McWane Inc. DI Pipe Group	Cement Lined	Blue	Cement Lined	Pantone Purple	Protecto 401	Pump Station
		US Pipe	Cement Lined	Blue	Cement Lined	Pantone Purple	Protecto 401	Pump Station
Sample	Sample Station	Sample Stations - Bacteriological Sample Station with built in flush system, all internal piping to be 2", brass and includes lockable green enclosures.						
		Safety-Guard	SG-BSS-05 pedestal #77	green enclosure	NA	NA	NA	NA
		Water Plus Corp	Model 5000	green	NA	NA	NA	NA
Services	Brass Service Saddles	Brass Service Saddles for 1" & 2" water & reclaimed water services on 4" through 12" Mains - Service saddles can be hinge or bolt controlled OD saddles to be used on C-900 and existing IPS OD PVC pipe.						
		Ford	Series S-70, S-90	4"-12"	Series S-70, S-90	4"-12"	NA	NA
		AY McDonald	Model 3891 / 3895,3801 / 3805	4"-12"	Model 3891 / 3895,3801 / 3805	4"-12"	NA	NA
		Mueller	Series S-13000/H-13000	4"-12"	Series S-13000/H-13000	4"-12"	NA	NA
	Services	Service Saddles	Service Saddles for 1" (CC) & 2" (Iron pipe threads) Water & Reclaimed Water services on mains greater than 12". Service saddles for 2" taps (iron pipe threads) on 4" mains and greater for Waste Water. : Epoxy or nylon coated stainless steel 18-8-type 304 double straps, controlled O.D. saddles to be used on C-900 / C905 or DI for all 1-in and -2in taps on pipes over 12in.					
Ford			Series FC202	16" & greater	Series FC202	16" & greater	Series FC202	4" & greater
JCM			Series 406	16" & greater	Series 406	16" & greater	Series 406	4" & greater
Mueller			DR2S	16" & greater	DR2S	16" & greater	DR2S	4" & greater
Romac			Series 202NS	16" & greater	Series 202NS	16" & greater	Series 202NS	4" & greater
Smith Blair			Series 317	16" & greater	Series 317	16" & greater	Series 317	4" & greater
Services	Service Saddles for HDPE	Service Saddles for 1" (CC) & 2" (Iron Pipe threads) Water and Reclaimed Water Services: Epoxy or nylon coated stainless steel 18-8-type 304 double straps, controlled O.D. saddles to be used on HDPE for all 1-in and -2in taps. Taps to HDPE pipe shall be approved on a case by case basis.						
		Ford	Series FCP202		Series FCP202		Series FCP202	
		Romac	Series 202N-H		Series 202N-H		Series 202N-H	
		Smith Blair	Series 317-1 for HDPE		Series 317-1 for HDPE		Series 317-1 for HDPE	
Corporation	Stops Ball Type	Corporation Stops Ball Type (1-inch with AWWA taper C threads only/pack joint outlet for CTS) 2" Corporation Stop Ball Type shall be 2" MIP X FIP threads.						
		Ford	FB1000, FB1700-7		FB1000, FB1700-7		FB1700-7	2" ARV
		AY McDonald	4701B-22, 3149B2		4701B-22, 3149B2		3149B2	2" ARV
		Mueller	P25008, B-20046		P25008, B-20046		B-20046	2" ARV

Cat.	Desc	Manufacturer	Water		Reclaimed Water		Wastewater	
			Model #	Comments	Model #	Comments	Model #	Comments
Services	Curb Stops	Curb Stops - Straight Valves: Ball type compression 2" cts O.D. tubing by 2" FIP						
		Ford	B41-777W		B41-777W		NA	NA
		AY McDonald	6102W-22		6102W-22		NA	NA
		Mueller	P25172		P25172		NA	NA
	Curb Stops	Curb Stops - Straight Valves: ball type compression x compression						
		Ford	B44-444W		B44-444W		NA	NA
		AY McDonald	6100W-22		6100W-22		NA	NA
		Mueller	P25146		P25146		NA	NA
	PE tubing	Polyethylene tubing: AWWA C901. UV protection (SDR-9) 1-inch and 2-inch only. PE 3408 / PE 4710						
		Charter Plastics	Blue Ice		Lav Ice		NA	NA
		Endot	Endopure Blue		Endocore Lavender		NA	NA
		JM Eagle	Pure-Core		NA	NA	NA	NA
Line Stops	Line Stops							
	JCM							
	Romac							
	Smith Blair							
Tapping Sleeves and Valves	Tapping Sleeves	Tapping Sleeves: (Mechanical joint for taps on cast iron, ductile iron, PVC & AC pipe, including size on size) with stainless steel nuts and bolts.						
		American Flow Control	Series 2800		Series 2800		Series 2800	
			Series 1004		Series 1004		Series 1004	
		Clow	Series F-5205	DIP/PVC	Series F-5205	DIP/PVC	Series F-5205	DIP/PVC
			Series F-5207	A/C Pipe	Series F-5207	A/C Pipe	Series F-5207	A/C Pipe
		JCM	Series 414	FBE	Series 414	FBE	Series 414	FBE
		Mueller	Series H-615	DIP/PVC	Series H-615	DIP/PVC	Series H-615	DIP/PVC
			Series H-619	A/C Pipe	Series H-619	A/C Pipe	Series H-619	A/C Pipe
Smith Blair	Style 623	FBE	Style 623	FBE	Style 623	FBE		
Tapping Valves: 12" and smaller	Tapping Valves: 12" and smaller - Tapping Valves shall be furnished with an alignment lip and installed in the vertical position for Water and Reclaim Water. Wastewater shall be installed horizontally and abandoned in the open position. Tapping valves shall be resilient seated only and meet the requirements of AWWA C509 or C515							
	American Flow Control	Series 2500	Alignment Lip	Series 2500	Alignment Lip	Series 2500	Alignment Lip	
	Clow	Series F-6114	Alignment Lip	Series F-6114	Alignment Lip	Series F-6114	Alignment Lip	
	Mueller	Series T2360 (4"-12")	Alignment Lip	Series T2360 (4"-12")	Alignment Lip	Series T2360 (4"-12")	Alignment Lip	

APPENDIX D

LIST OF APPROVED PRODUCTS - TRANSMISSION SYSTEMS

FEBRUARY 11, 2011

Cat.	Desc	Manufacturer	Water		Reclaimed Water		Wastewater	
			Model #	Comments	Model #	Comments	Model #	Comments
Tapping Sleeves and Valves	Tapping Valves: 16" and Larger	Tapping Valves: 16" and Larger - Tapping valves shall be furnished with an alignment lip and be installed in the vertical position for Water and Reclaimed Water. No tapping valve shall be installed horizontally for Water and Reclaim Water unless approved by the engineer. Tapping Valves 16" and larger AWWA C515 resilient seated only (16" and 24" no gearing required) above 24" shall be installed vertically with a spur gear actuator unless noted by the engineer. All tapping valves above 24" shall be furnished with NPT pipe plugs for flushing the tracks when valves are installed horizontally. Tapping valves for Wastewater shall be installed horizontally and abandoned in open position.						
		American Flow Control	Series 2500	Alignment Lip & flushing port	Series 2500	Alignment Lip & flushing port	Series 2500	Alignment Lip & flushing port
		Clow	Series F-6114	Alignment Lip & flushing port	Series F-6114	Alignment Lip & flushing port	Series F-6114	Alignment Lip & flushing port
		Mueller	Series T2361 (14"&up)	Alignment Lip & flushing port	Series T2361 (14"&up)	Alignment Lip & flushing port	Series T2361 (14"&up)	Alignment Lip & flushing port
Valves	Butterfly Valve 42" and Above	Butterfly Valves 42"and above. AWWA C504. Actuators input torques based on 150 psi valve pressure and 16 fps velocity with a maximum input of 80 ft-lb on 2" nuts and shall withstand 250 ft-lbs. Valve seats shall be leak-tight in both directions at 150 psi.						
		Clow	Style #1450		Style #1450		NA	NA
		Dezurik	BAW		BAW		NA	NA
		Mueller / Pratt	LINSEAL III / Groundhog		LINSEAL III / Groundhog		NA	NA
	Check Valves	Valves (Check) 4-inch and Larger (8 mil epoxy lined)						
		American Flow Control	NA		NA		Series 600 or 50 line	
		Clow / M&H / Kennedy	NA		NA		106	
	Gate Valves 4" - 12"	Gate Valves 12" and smaller - resilient seated only AWWA C509 or C515. Valve seat shall be leak-tight in both directions at 150 psi.						
		American Flow Control	Series 2500		Series 2500		NA	NA
		Clow	Series F-6100		Series F-6100		NA	NA
Mueller		Series A-2360		Series A-2360		NA	NA	
Gate Valves (Vertical) 16" and Up	Gate Valves 16" and larger (Vertical Installation) AWWA C515 resilient seated only (16" and 24" no gearing required) above 24" shall be installed vertically with a gear actuator unless noted by the engineer. Valve seat shall be leak-tight in both directions at 150 psi.							
	American Flow Control	Series 2500		Series 2500		NA	NA	
	Clow	Series F-6100		Series F-6100				
	Mueller	Series A-2361		Series A-2361		NA	NA	

Cat.	Desc	Manufacturer	Water		Reclaimed Water		Wastewater			
			Model #	Comments	Model #	Comments	Model #	Comments		
Valves	Plug Valves	Plug Valves - Bi-directional, MJ & Flanged (min. 8mil fusion bonded epoxy with stainless steel bolts), gear operator to be sized for rated pressure of the valve. Valves 4"-20" shall be 80% Full Port and valves 24" and greater shall be minimum of 70% full port. Valve shall be factory tested to minimum 100 PSI in both directions.								
		Clow	NA	NA	NA	NA	F-5412 FLG	4" & up		
			NA	NA	NA	NA	F-5413 MJ	4" & up		
		Dezurik	NA	NA	NA	NA	Series PEF or PEC	4" & up		
		Millikan / Pratt	NA	NA	NA	NA	Eccentric / Ballcentric	4" & up		
		Val-Matic	NA	NA	NA	NA	5600 or 5800 (FLG)	4" & up		
NA	NA		NA	NA	5700 or 5900 (MJ)	4" & up				
Valve Boxes	Valve Boxes with Locking Lids (Cast Iron)	Two piece standard screw type Heavy Duty Valve Boxes with Locking Lids (Cast Iron) and type of service cast in heavy duty traffic lid (H2O loading) ASTM A48								
		Bingham/Taylor	Series 4905	Box	NA	NA	Series 4905	Box		
			4905-X	Extension	NA	NA	4905-X	Extension		
			4904-L	Blue Water Locking Lid	NA	NA	4904-L	Green Sewer locking Lid		
		Sigma	Series VB 261X-267X	Box	VB-25031LK-VB-2612	Box	Series VB 261X-267X	Box		
			VB 6302	Extension	VB-6302	Extension	VB 6302	Extension		
			VB 4650W	Blue Water Locking Lid	VB2503LK	Purple Square Locking Lid	VB 4650S	Green Sewer locking Lid		
		Star	Series VB-0002	Box	NA	NA	Series VB-0002	Box		
			VBEX 12-24S	Extension	NA	NA	VBEX 12-24S	Extension		
			VBLIDLOCK	Blue Water Locking Lid	NA	NA	VBLIDLOCK	Green Sewer locking Lid		
		Tyler Union	Series 6850	Box	NA	NA	Series 6850	Box		
			58, 59, 60	Extension	NA	NA	58, 59, 60	Extension		
			Locking Lid	Blue Water Locking Lid	NA	NA	Locking Lid	Green Sewer locking Lid		
		Valve Box	Valve Box	For mains equal to, or greater than, 16" diameter or equal to greater than 6' feet deep						
				American Flow Control	# 2A - 9A Retrofit Valve Box Insert	Fit inside std valve boxes	NA		2A - 9A Retrofit Valve Box Insert	Green Sewer locking Lid
Mueller Company	MVB050C thru MVB130C with Extension Stem			Blue Water Locking Lid	MVB050CR thru MVB130CR with Extension Stem	Purple Square Locking Reclaim Lid	MVB050C thru MVB130C with Extension Stem	Green Sewer locking Lid		
		MVB875 Guide Plate		MVB875 Guide Plate		MVB875 Guide Plate				

APPENDIX D

LIST OF APPROVED PRODUCTS - GRAVITY SYSTEMS

FEBRUARY 11, 2011

Cat.	Desc	Manufacturer	Water		Reclaimed Water		Wastewater	
			Model #	Comments	Model #	Comments	Model #	Comments
Coatings	Anti-Graffiti Paint	Block Walls-Anti-Graffiti Paint per Section 3119 Coatings & Linings						
		American Building Restoration Products	NA	NA	NA	NA	Polyshield Graffiti Preventer for Unpainted Masonry Type B	Super Bio Strip or Strip it all
		Tnemec / Chemprobe	NA	NA	NA	NA	626 DUR A PEL	680 Mark A Way
		Professional Products of Kansas, Inc	NA	NA	NA	NA	Professional Water Seal & Anti-Graffiti (PWS-15 Super Strength)	Professional Phase II Cleaner
	Coatings for Existing Manholes	Rehabilitation corrosion protection system per Section 3119 Coatings & Linings. Interior coating for force main connections to existing concrete manholes only. New precast structures and existing pump stations shall be lined.						
		CCI Spectrum, Inc	NA	NA	NA	NA	Spectrashield	min of 500 mils
		Kerneos Aluminate Technologies	NA	NA	NA	NA	Sewpercoat	1" (1000mil)
		Raven Lining System	NA	NA	NA	NA	Raven 155 Primer Raven 405	min 8 mils min 125 mils
		Sauereisen	NA	NA	NA	NA	210 Series Topcoat Glaze 210G	min 125 mils min 20 mils
		Tnemec	NA	NA	NA	NA	Series 434 Topcoat Glaze 435	min 125 mils 15-20 mils
PVC Pipe and fittings	Pipe SDR 35 Gravity Mains	PVC Pipe for Gravity SDR26/SDR 35 (Green in color) ASTM-D034. Manufacturers shall be members in good standing with Uni-Bell to maintain approval status.						
		Certainteed	NA	NA	NA	NA	Gravity Sewer Pipe	
		Diamond Plastics Corp	NA	NA	NA	NA	Sani-21 SDR-35	
		JM Eagle	NA	NA	NA	NA	Gravity Sewer	
		National Pipe & Plastics, Inc.	NA	NA	NA	NA	Ever-Green Sewer Pipe	
		North American Pipe Corp (NAPCO)	NA	NA	NA	NA	Gravity Sewer	
		Sanderson Pipe Corp	NA	NA	NA	NA	Gravity Sewer	
	Locate Balls	Locating Marker Systems - Wastewater Locator balls placed at all sanitary sewer cleanouts						
		3M	NA	NA	NA	NA	3M™ EMS 4" Extended Range 5' Ball Marker 1404-XR	
	Fittings SDR 35	Fittings, Adapters and Plugs - Gravity PVC ASTM-D3034, Min SDR26/ SDR 35						
GPK Products, Inc.		NA	NA	NA	NA	SDR26/SDR35 Gasketed sewer fittings		
Harrington Corporation (HARCO)		NA	NA	NA	NA	SDR26/SDR35 Gasketed sewer fittings		
Multi Fittings Corp.		NA	NA	NA	NA	SDR26/SDR 35 Trench Tough Sewer Fittings		
JM Eagle		NA	NA	NA	NA	SDR26/SDR35 Gasketed sewer fittings		
Plastic Trends Inc		NA	NA	NA	NA	SDR26/SDR35 Gasketed sewer fittings		
	TIGRE USA, Inc.	NA	NA	NA	NA	SDR26/SDR35 Gasketed sewer fittings		

APPENDIX D

LIST OF APPROVED PRODUCTS - GRAVITY SYSTEMS

FEBRUARY 11, 2011

Cat.	Desc	Manufacturer	Water		Reclaimed Water		Wastewater	
			Model #	Comments	Model #	Comments	Model #	Comments
PVC Pipe a	Flexible Pipe Connectors	Flexible Pipe Connectors and Transitions						
		Fernco	NA	NA	NA	NA	1002, 1051, 1056 Series	
		Indiana Seal	NA	NA	NA	NA	102, 151, 156 Series	
		Mission Rubber	NA	NA	NA	NA	MR02, MR51, MR 56 Series	
Precast Concrete Structures	MH Lids	Frame and Cover						
		USF Fabrication Inc.	NA	NA	NA	NA	USF 225-AS	
	Adj Ring	Top Adjusting Rings - HDPE with heavy duty loading (H-20)						
		Ladtech, Inc	NA	NA	NA	NA	24R, 24S with Rope Sealant CS2455	
	Hatches	Wet Well and Valve Vault Access Frames and Covers (Include the term "Confined Space" etched or cast into the cover with recessed lock & hasp. Frames and covers per manufacturers specifications.						
		Halliday Products	NA	NA	NA	NA	S1R or S2R Series	
		USF Fabrication Inc.	NA	NA	NA	NA	APS or APD Series	
	Precast Concrete Structures	Precast Manhole and Wetwell Structures ASTM C478. Precast concrete shall be batched with concrete dyed crystalline waterproofing admixture with corrosion protection. Concrete without admixture or without color tint /tracer shall be rejected.						
		Allied Precast	NA	NA	NA	NA	Dyed Admix	
		Atlantic Concrete Products, Inc.	NA	NA	NA	NA	Dyed Admix	
		Delzotto Products, Inc.	NA	NA	NA	NA	Dyed Admix	
		Dura Stress Underground Inc.	NA	NA	NA	NA	Dyed Admix	
		Hanson Pipe & Product	NA	NA	NA	NA	Dyed Admix	
		Mack Concrete	NA	NA	NA	NA	Dyed Admix	
		Oldcastle Precast	NA	NA	NA	NA	Dyed Admix	
	Standard Precast Inc.	NA	NA	NA	NA	Dyed Admix		
	Concrete Admix	Crystalline Waterproofing Concrete Admix with color dye shall be added to all concrete structures (precast and cast-in-place) to provide waterproofing and corrosion resistance. Concrete without admixture or without color tint / tracer shall be rejected. % concentration of admix with colored dye added to the mix shall be based on weight of cement.						
Kryton International		NA	NA	NA	NA	KIM K-301R (with red dye)	2%	
Xypex Chemical Corp		NA	NA	NA	NA	Xypex Admix C-1000Red (with red dye)	3.0 - 3.5%	
Liners	Interior Liner for New or existing Precast Manhole and Precast Wetwell Structures per Section 3119 Coatings & Linings							
	AFE	NA	NA	NA	NA	Fiberglass Liner		
	AGRU Liner	NA	NA	NA	NA	HDPE Liner (Min 2 mm for Manhole / Min 5 mm for Pump Station)		
	Containment Solutions Inc. (Flowtite)	NA	NA	NA	NA	Fiberglass Liner		
	GSE Studliner	NA	NA	NA	NA	HDPE Liner (Min 2 mm for Manhole / Min 5 mm for Pump Station)		
	GU Liner	NA	NA	NA	NA	Reinforced Plastic Liner		
		L & F Manufacturing	NA	NA	NA	NA	Fiberglass Liner	

APPENDIX D

LIST OF APPROVED PRODUCTS - GRAVITY SYSTEMS

FEBRUARY 11, 2011

Cat.	Desc	Manufacturer	Water		Reclaimed Water		Wastewater		
			Model #	Comments	Model #	Comments	Model #	Comments	
Precast Concrete Structures	Heat Shrink Seal	Heat Shrink Seal - Precast structures shall be primed with manufacturer approved primer prior to application of heat shrunk encapsulation.							
		Canusa-CPS	NA	NA	NA	NA	Wrapid Seal with WrapidSeal Primer (Canusa G Primer)		
		Pipeline Seal & Insulator, Inc (PSI)	NA	NA	NA	NA	Riser Wrap with Polyken 1027 or 1039 primer		
	Joining Material	Joining Material Min. 2" width for all products to ensure squeeze out with manufacturer approved primer.							
		Henry Company	NA	NA	NA	NA	Ram-Nek	with Primer	
		Martin Asphalt Company	NA	NA	NA	NA	Evergrip 990	with Primer	
		Trelleborg Pipe Seals	NA	NA	NA	NA	NPC – Bidco C-56	with Primer	
	Pipe Seals Gravity	Resilient Connector Pipe Seals, Manhole - Gravity less than 12-inch and less than 15-ft deep							
		Atlantic Concrete	NA	NA	NA	NA	A-Lok (cast-in-place)		
		Hail Mary Rubber	NA	NA	NA	NA	Star Seal (cast-in-place)		
		IPS	NA	NA	NA	NA	Wedge Style		
		NPC	NA	NA	NA	NA	Kor-N-Seal Model WS		
		Press seal gasket	NA	NA	NA	NA	PSX Direct Drive		
	Pipe Seals Gravity	Cast in Place Pipe Seals, Manhole - Gravity Greater Than or Equal to 12-inch and all pipe sizes greater than 15-ft deep							
		Atlantic Concrete	NA	NA	NA	NA	A-Lok	cast in place	
		Hail Mary Rubber	NA	NA	NA	NA	Star Seal	cast in place	
	FM Pipe Seals	Modular Pipe Seals for Wet Well and Valve Box penetrations and all forcemain connections to existing and new precast concrete structures. EPDM Rubber with 316 SS Hardware							
		CCI Pipeline Systems	NA	NA	NA	NA	Wrap-It Link WL-SS Series		
		Pipeline Seal & Insulator, Inc / Link Seal	NA	NA	NA	NA	Link-Seal S-316 Modular Seal		
		Proco Products, Inc	NA	NA	NA	NA	PenSeal ES-PS Series		

APPENDIX D

LIST OF APPROVED PRODUCTS - PUMP STATION SYSTEMS

FEBRUARY 11, 2011

Cat.	Desc	Manufacturer	Water		Reclaimed Water		Wastewater	
			Model #	Comments	Model #	Comments	Model #	Comments
Generator	Gen	Generator Systems, Fixed Shall be UL 2200 Certified.						
		Caterpillar	NA	NA	NA	NA	CAT Diesel Generator Set	
		Cummins Power Generation	NA	NA	NA	NA	Diesel Generator Set	
	Fuel Tanks	Generator Fuel Tanks. Shall be UL2085 certified.						
		Convault	NA	NA	NA	NA	CVT-3SF or CVT-3FF	
		Phoenix	NA	NA	NA	NA	Envirovault	
	GR	Generator Receptacle (GR)						
		Cooper Crouse-Hinds	NA	NA	NA	NA	AR2042 (230V, 200A, 3P, 4W) With AJA1 Angle Adaptor	
		Cooper Crouse-Hinds	NA	NA	NA	NA	AR2042-S22 (460V, 200A, 3P, 4W) With AJA1 Angle Adaptor	
		Pyle National	NA	NA	NA	NA	JRE-4100 (230V, 100A, 3P, 4W)	
ATS	Generator Transfer Switch							
	Russelectric	NA	NA	NA	NA	RMTD Series with model 2000 controller	NEMA 12/3R 316SS Enclosure	
Odor Control Units	Biotrickling Filters	Biotrickling filters						
		BioAir	NA	NA	NA	NA		
		Bioem	NA	NA	NA	NA	Biosorbens BTF	
		Envirogen	NA	NA	NA	NA	BTF	
		Siemens	NA	NA	NA	NA	Zabocs BTF	
	Carbon Adsorption Units	Carbon Adsorption Units						
		Calgon	NA	NA	NA	NA		
		Pure Air Filtration	NA	NA	NA	NA		
		Siemens	NA	NA	NA	NA		
	Pressure Gauges	Pressure Gauges shall have Diaphragm Seals. Oil filled.						
Ashcroft		NA	NA	NA	NA	10 1008SL 02L 60#	Gauge Diaphragm Seal	
		25 200SS 02T XYTSE						
Terice		NA	NA	NA	NA	D83LFSS4002LA100 - Gauge		
						M51001SSSS - Diaphragm Seal		
Winter Gauges	NA	NA	NA	NA	D99100 Fill and Mount Charge			
Pumps	Submersible Pumps							
	ABS	NA	NA	NA	NA			
	Flygt	NA	NA	NA	NA	PFQ770 0-60 PSI D70950 top D70954 Bottom		

APPENDIX D

LIST OF APPROVED PRODUCTS - PUMP STATION SYSTEMS

FEBRUARY 11, 2011

Cat.	Desc	Manufacturer	Water		Reclaimed Water		Wastewater	
			Model #	Comments	Model #	Comments	Model #	Comments
Pumps	Floats	Float Regulator (FR) - Duplex and Triplex Pump Stations						
		Atlantic Scientific	NA	NA	NA	NA	Roto-Float	
	Radar	Radar - Pulse Burst Radar Transmitter. Input 24 VDC and Output 4-20 mA						
		Magnetrol	NA	NA	NA	NA	R82-520A-011	
Pump Station Main Ser	Main Srvce Disconnect	Main Service Disconnect Breaker						
		Square D	NA	NA	NA	NA	H or J Frame 3 Pole 600 Volt (HGL or JGL determined by amperage)	
	Surge Protector Device	Surge Protector - UL 1449, 3rd Edition listed and labeled, minimum 10 year warranty, NEMA LS-1 and IEEE C62, 41/45 tested with NEMA 4X enclosure, internal fusing, voltage and phase to match service. Rated 80,000 amps per mode for Duplex & Triplex stations and 150,000 Amperes per mode for Master Stations. All devices shall be provided with a NEMA 4X Plastic enclosure which is approved in lieu of stainless steel.						
		Current Technology (Power & Systems)	NA	NA	NA	NA	XN-80, TG-150 or CurrentGuard 150 Plus Series	
		Joslyn AKA (Total Protection Solutions)	NA	NA	NA	NA	TSS-ST 160 Series, ST 300 Series or JSP-300 Series	
		Surge Suppressors, Inc	NA	NA	NA	NA	LSE Series or SHL Series	
Sub Panel	Sub Panel	Sub-Panel Enclosure - NEMA 12/3R Enclosure 316SS, white polyester Powder coated finish inside and out, With 3 Point Pad lockable Handle, and Door Stop						
		Hoffman	NA	NA	NA	NA		
		Schaefer	NA	NA	NA	NA		
		Universal enclosure systems	NA	NA	NA	NA		
Pump Station Control Panel	Control Panel	Control Panel Supplier						
		ECS	NA	NA	NA	NA		
		Sta-Con Inc	NA	NA	NA	NA		
	Enclosure	Enclosure - NEMA 12/3R Enclosure 316SS, white polyester Powder coated finish inside and out, With 3 Point Pad lockable Handle, and Door Stop						
		Hoffman	NA	NA	NA	NA		
		Schaefer	NA	NA	NA	NA		
		Universal enclosure systems	NA	NA	NA	NA		
	Mnts	Mounting Channel for Enclosures						
		Unistrut Stainless Steel	NA	NA	NA	NA	1" 5/8 x 1" 5/8 316 SS	
	Seal-off	Explosion-Proof Sealoff						
	Cooper Crouse-Hinds	NA	NA	NA	NA	EYSR - 2 Inch Min.		
FL	Flasher (FL)							
		MPE	NA	NA	NA	NA	025-120-105	
		SSAC	NA	NA	NA	NA	FS-126	

APPENDIX D

LIST OF APPROVED PRODUCTS - PUMP STATION SYSTEMS

FEBRUARY 11, 2011

Cat.	Desc	Manufacturer	Water		Reclaimed Water		Wastewater		
			Model #	Comments	Model #	Comments	Model #	Comments	
Pump Station Control Panel	AL	Alarm Light / With Base and Globe (AL)							
	American Electric	NA	NA	NA	NA	F32552			
	Red Dot Globe	NA	NA	NA	NA	VGLR-01			
	Red Dot Base					VA-01			
	AH	Alarm Horn (AH)							
	Wheelock	NA	NA	NA	NA	3IT-115-R			
	Fuse	Fuses (F)							
	Bussmann	NA	NA	NA	NA	FNQ-R or KTK-R			
	HOA	Hand-Auto-Off Selector (HOA)							
	Square D	NA	NA	NA	NA	9001-SKS43B			
	HSS	Horn Silence Button (HSS)							
	Square D	NA	NA	NA	NA	9001-SKR1RH5			
	Inter-lock	Mechanical Interlock							
	Square D	NA	NA	NA	NA	S29354			
	Breakers	Control Panel Main Circuit Breaker (MCB) With S29450 Circuit Breaker Auxiliary Switch							
		Square D	NA	NA	NA	NA	H or J Frame 3 Pole 600 Volt (HGL or JGL determined by amperage)		
		Emergency Circuit Breaker (ECB) With S29450 Circuit Breaker Auxiliary Switch							
		Square D	NA	NA	NA	NA	H or J Frame 3 Pole 600 Volt (HGL or JGL determined by amperage)		
		Motor Circuit Breaker (MB)							
	Square D	NA	NA	NA	NA	H or J Frame 3 Pole 600 Volt (HGL or JGL determined by amperage)			
	Control Circuit Breaker/ GFCI Receptacle Breaker/ SCADA Breaker								
	Square D	NA	NA	NA	NA	QOU120			
	MS	Motor Starter (MS)							
Square D	NA	NA	NA	NA	Type S Class 8536				
OL	Overload Heater(OL)								
Square D	NA	NA	NA	NA	Part number will vary with size needed				
OR	Overload Reset								
Square D	NA	NA	NA	NA	9066-RA1				
Transformer	Control Circuit Transformer (XMFR)								
	Square D	NA	NA	NA	NA	9070TF75D23	120/24 Volt .075 KVA		
	Main Circuit Transformer (MCT)								
Square D	NA	NA	NA	NA	9070T2000D1	480/120 2KVA			
SPB	Supplemental Protector Breaker - 3 pole, 1-amp for Phase Monitor								
Square D	NA	NA	NA	NA	MG24532				

APPENDIX D

LIST OF APPROVED PRODUCTS - PUMP STATION SYSTEMS

FEBRUARY 11, 2011

Cat.	Desc	Manufacturer	Water		Reclaimed Water		Wastewater	
			Model #	Comments	Model #	Comments	Model #	Comments
Pump Station Control Panel	PM	Phase Monitor (PM)						
		MPE 240 V.	NA	NA	NA	NA	001-230-118-OVG5	
		MPE 480 V.	NA	NA	NA	NA	002-480-123-OVG5	
	Pump Alternator	Pump Automatic Alternator (PAA)						
		Diversified Duplex	NA	NA	NA	NA	ARA-120-ACA	
		Diversified Triplex	NA	NA	NA	NA	ARA-120-AME	
		MPE Duplex	NA	NA	NA	NA	008-120-13SP	
		MPE Triplex	NA	NA	NA	NA	009-120-23P	
	MPE Triplex Socket	NA	NA	NA	NA	SD-12-PC		
	Alt. Test Switch	Alt. Test Switch						
		Carling Technologies	NA	NA	NA	NA	6GG5E-78	
		Honeywell	NA	NA	NA	NA	2TL1-50	
	Relay	Relay						
		Potter Brumfield 24 Volt	NA	NA	NA	NA	KRPA-11AN-24	
		Potter Brumfield 120 Volt	NA	NA	NA	NA	KRPA-11AN-120	
		Square D 24 Volt	NA	NA	NA	NA	8501KP12P14V14	
	Square D 120Volt	NA	NA	NA	NA	8501KP12P14V20		
	Relay Base	Relay Base						
		IEDC 8 Pin Relay Base 600 Volt	NA	NA	NA	NA	SR2P-06	
	Duplex Receptacle / GFCI	Duplex Receptacle/GFCI (DR) Upgraded to 20 Amp						
		Hubbell	NA	NA	NA	NA	GFTR20BK	
		Pass & Seymour	NA	NA	NA	NA	2095TRBK	
	ETM	Elapse Time Meter (ETM)						
		Reddington	NA	NA	NA	NA	711-0160	
	Grounding	Grounding System						
		Marathon	NA	NA	NA	NA	Neutral Isolation Block 1421570	
		Panduit	NA	NA	NA	NA	Ground Lug LAM2A 1/0 - 014 -6Y	
	Square D	NA	NA	NA	NA	Ground Buss PK7GTA		
TS	Terminal Strip (TS)							
	Marathon	NA	NA	NA	NA	Series 200		
	Square D	NA	NA	NA	NA	9080GR6		
TS	Terminal Strip End Blocks and End Clamps							
	Square D	NA	NA	NA	NA	9080GM6B & 9080GH10		

APPENDIX D

LIST OF APPROVED PRODUCTS - PUMP STATION SYSTEMS

FEBRUARY 11, 2011

Cat.	Desc	Manufacturer	Water		Reclaimed Water		Wastewater	
			Model #	Comments	Model #	Comments	Model #	Comments
Pump Station Control Pane	PL	Pilot Light (PL) 24 Volt with 1819 Bulb						
		Dialight	NA	NA	NA	NA	803-1710	
		Lighting Components & Design	NA	NA	NA	NA	Littlelight 930507X	
	RL	Run Indicator Light (RL) 120 Volt						
		Dialight	NA	NA	NA	NA	803-1710	
		Lighting Components & Design	NA	NA	NA	NA	Littlelites 930507X With 120MB Bulb	
	MT	Moisture and Temperature Failure Light (MT) 120 Volt with 120MB Bulb						
		Dialight	NA	NA	NA	NA	803-1710	
		Lighting Components & Design	NA	NA	NA	NA	Littlelites 930507X	
Sluice Gate	Sluice Gate for Wet Well with Motorized Operator							
	BNW	NA	NA	NA	NA	Model 77 - 316 SS		
	Fontaine	NA	NA	NA	NA	Model 20 - 316 SS		
VFD	Variable Frequency Drives							
	Square D	NA	NA	NA	NA			

APPENDIX E

ORANGE COUNTY UTILITIES

BOUNDARY SURVEY(S)

(For Boundary Surveys for PS #3887, PS #3893, and PS #3890,
Please See Sheets V300, V400, and V500)

BOUNDARY SURVEY-PUMP STATION 3309
ORANGE COUNTY, FLORIDA

LEGAL DESCRIPTION:

A PORTION OF TRACT "A", RIVEN PINES, ACCORDING TO THE PLAT THEREOF, AS RECORDED IN PLAT BOOK 13, PAGE 12 OF THE PUBLIC RECORDS OF ORANGE COUNTY, FLORIDA, BEING MORE PARTICULARLY DESCRIBED AS FOLLOWS:

BEGIN AT THE NORTHWEST CORNER OF SAID TRACT "A"; THENCE RUN N89°57'30"E ALONG THE NORTH LINE OF SAID TRACT "A", A DISTANCE OF 34.40 FEET; THENCE, DEPARTING SAID NORTH LINE, RUN THE FOLLOWING COURSES AND DISTANCES: S00°09'44"W 15.84 FEET; THENCE S57°25'41"W 18.33 FEET; THENCE N89°56'53"W A DISTANCE OF 18.83 FEET TO A POINT ON THE WEST LINE OF THE AFORESAID TRACT "A"; THENCE RUN N00°09'00"W, ALONG SAID WEST LINE, A DISTANCE OF 25.66 FEET TO THE POINT OF BEGINNING.

CONTAINING 806 SQUARE FEET, MORE OR LESS.

SURVEYOR'S REPORT:

1. THIS BOUNDARY SURVEY IS NOT VALID UNLESS SIGNED AND EMBOSSED WITH A RAISED SEAL OF A FLORIDA LICENSED SURVEYOR AND MAPPER.
2. THE LIMITS OF THE BOUNDARY SURVEY ARE AS DIRECTED BY THE CLIENT.
3. THE LEGAL DESCRIPTION, SHOWN HEREON, WERE PREPARED BY THE SURVEYOR.
4. LANDS, SHOWN HEREON, WERE NOT RESEARCHED BY THIS FIRM FOR OWNERSHIP, EASEMENTS, RIGHT OF WAY OR OTHER MATTERS IN THE PUBLIC RECORDS THAT MAY AFFECT THESE LANDS.
5. BEARINGS SHOWN HEREON ARE BASED ON THE SOUTH RIGHT OF WAY LINE OF LENA STREET, AS BEING NORTH 89°57'30" EAST.
6. BEARINGS AND COORDINATES SHOWN HEREON ARE RELATIVE TO THE FLORIDA STATE PLANE COORDINATE SYSTEM EAST ZONE NORTH AMERICAN DATUM OF 1983/1990 ADJUSTMENT.
7. LAST DAY IN THE FIELD: APRIL 8, 2014.
8. GRAPHIC SYMBOLS, SHOWN HEREON, MAY NOT BE TO MAP SCALE.
9. THIS BOUNDARY SURVEY IS HEREBY CERTIFIED TO: ORANGE COUNTY, FLORIDA AND FIRST AMERICAN TITLE INSURANCE COMPANY.

SURVEYOR'S CERTIFICATION:

THIS BOUNDARY SURVEY WAS PREPARED UNDER MY DIRECTION AND IS TRUE AND CORRECT TO THE BEST OF MY KNOWLEDGE AND BELIEF. THIS BOUNDARY SURVEY WAS PERFORMED IN CONFORMANCE WITH THE "MINIMUM TECHNICAL STANDARDS FOR SURVEYS" AS CONTAINED IN CHAPTER 5J-17, FLORIDA ADMINISTRATIVE CODE, PURSUANT TO FLORIDA STATUTE 472.

William L. Miller 5/28/14

WILLIAM L. MILLER, PLS DATE
FLORIDA SURVEYOR AND MAPPER LS 5010
BARNES FERLAND AND ASSOCIATES LB 7774
*NOT VALID WITHOUT THE SIGNATURE AND ORIGINAL
RAISED SEAL OF THE FLORIDA LICENSED SURVEYOR AND MAPPER

THIS SURVEY CONSISTS OF TWO SHEETS AND IS NOT COMPLETE WITHOUT SHEET 2 OF 2

REVISED: 5/22/14	PER COMMENTS FROM ORANGE COUNTY
---------------------	---------------------------------

BFA Environmental Consultants
Barnes, Ferland and Associates, Inc.
1230 E. Hillcrest Street, Orlando, FL, 32803
PH: (407) 895-0000 FAX: (407) 895-1000
CERTIFICATE OF AUTHORIZATION: LB7774

BOUNDARY SURVEY
PS 3309 LENA STREET
A PORTION OF TRACT A, RIVEN PINES
PB 13, PAGE 12, ORANGE COUNTY, FLORIDA

SHEET
1 OF 2

F:\CIVIL\PROJECTS\2011\11-1113 Package 1 Pump Stations\5.0 Drawings\2011-11.13 Package 1 PS 3309 Boundary Survey.dwg, 5/28/2014 7:02:40 AM

BOUNDARY SURVEY-PUMP STATION 3309
ORANGE COUNTY, FLORIDA

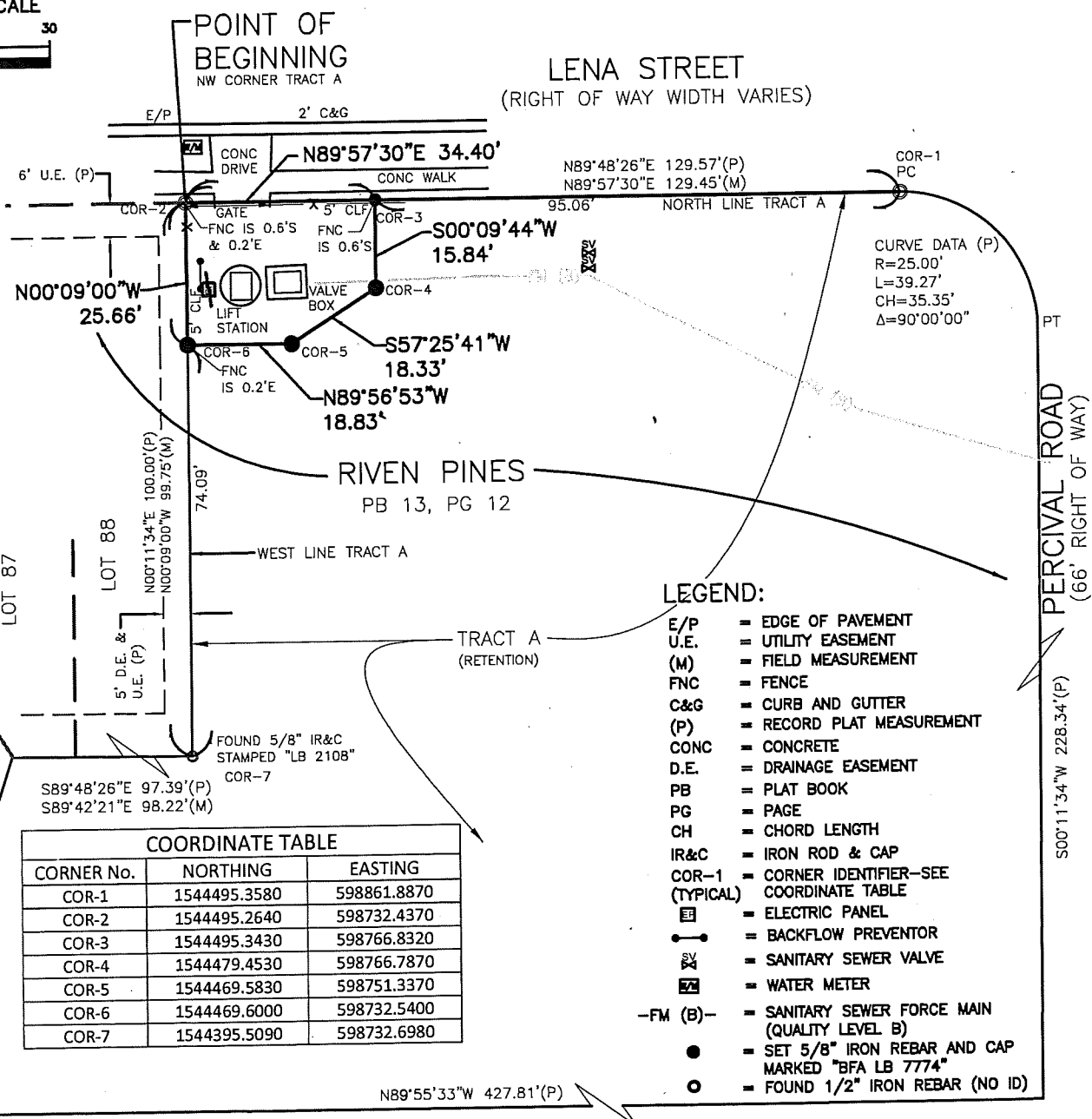
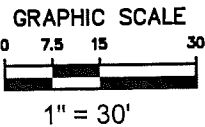

LEGEND:

- E/P = EDGE OF PAVEMENT
- U.E. = UTILITY EASEMENT
- (M) = FIELD MEASUREMENT
- FNC = FENCE
- C&G = CURB AND GUTTER
- (P) = RECORD PLAT MEASUREMENT
- CONC = CONCRETE
- D.E. = DRAINAGE EASEMENT
- PB = PLAT BOOK
- PG = PAGE
- CH = CHORD LENGTH
- IR&C = IRON ROD & CAP
- COR-1 (TYPICAL) = CORNER IDENTIFIER-SEE COORDINATE TABLE
- = ELECTRIC PANEL
- = BACKFLOW PREVENTOR
- = SANITARY SEWER VALVE
- = WATER METER
- FM (B)- = SANITARY SEWER FORCE MAIN (QUALITY LEVEL B)
- = SET 5/8" IRON REBAR AND CAP MARKED "BFA LB 7774"
- = FOUND 1/2" IRON REBAR (NO ID)

COORDINATE TABLE

CORNER No.	NORTHING	EASTING
COR-1	1544495.3580	598861.8870
COR-2	1544495.2640	598732.4370
COR-3	1544495.3430	598766.8320
COR-4	1544479.4530	598766.7870
COR-5	1544469.5830	598751.3370
COR-6	1544469.6000	598732.5400
COR-7	1544395.5090	598732.6980

THIS SURVEY CONSISTS OF TWO SHEETS AND IS NOT COMPLETE WITHOUT SHEET 1 OF 2

BFA Environmental Consultants
Barnes, Farland and Associates, Inc.
1230 E. Hillcrest Street, Orlando, FL 32803
Tel: (407) 825-1822 Fax: (407) 825-1822
CERTIFICATE OF AUTHORIZATION: LB7774

BOUNDARY SURVEY
PS 3309 LENA STREET
A PORTION OF TRACT A, RIVEN PINES
PB 13, PAGE 12, ORANGE COUNTY, FLORIDA

SHEET
2 OF 2

F:\CIVIL\PROJECTS\2011\11-11.13 Package 1 Pump Stations\5.0 Drawings\2011-11.13 Package 1 PS 3309 Boundary Survey.dwg, 5/29/2014 7:07:26 AM

UTILITY EASEMENT-PUMP STATION 3309

ORANGE COUNTY, FLORIDA

PARCEL: 801
ESTATE: PERPETUAL EASEMENT
PURPOSE: UTILITY

LEGAL DESCRIPTION:

A PORTION OF TRACT "A", RIVEN PINES, ACCORDING TO THE PLAT THEREOF, AS RECORDED IN PLAT BOOK 13, PAGE 12 OF THE PUBLIC RECORDS OF ORANGE COUNTY, FLORIDA, BEING MORE PARTICULARLY DESCRIBED AS FOLLOWS:

COMMENCE AT THE NORTHWEST CORNER OF SAID TRACT "A"; THENCE RUN N89°57'30"E ALONG THE NORTH LINE OF SAID TRACT "A", A DISTANCE OF 34.40 FEET FOR A POINT OF BEGINNING; THENCE CONTINUE N89°57'30"E ALONG SAID NORTH LINE, A DISTANCE OF 95.19 FEET TO THE POINT OF CURVATURE OF A CURVE CONCAVE SOUTHWESTERLY, HAVING A RADIUS OF 25.00 FEET; THENCE FROM A CHORD BEARING OF S45°01'30"E RUN SOUTHEASTERLY ALONG THE ARC OF SAID CURVE, THROUGH A CENTRAL ANGLE OF 90°01'59" AND AN ARC DISTANCE OF 39.27 FEET TO A POINT ON THE EAST LINE OF SAID TRACT "A", POINT ALSO BEING THE POINT OF TANGENCY; THENCE DEPARTING SAID NORTH LINE RUN S00°00'31"E ALONG SAID EAST LINE, A DISTANCE OF 106.22 FEET; THENCE, DEPARTING SAID EAST LINE, RUN THE FOLLOWING COURSES AND DISTANCES: S89°59'29"W A DISTANCE OF 10.00 FEET; THENCE N00°00'31"W A DISTANCE OF 101.23 FEET TO THE POINT OF CURVATURE OF A CURVE CONCAVE SOUTHWESTERLY HAVING A RADIUS OF 10.00 FEET; THENCE FROM A CHORD BEARING OF N45°01'30"W RUN NORTHWESTERLY ALONG THE ARC OF SAID CURVE, THROUGH A CENTRAL ANGLE OF 90°01'59" AND AN ARC DISTANCE OF 15.71 FEET TO THE POINT OF TANGENCY; THENCE S89°57'30"W A DISTANCE OF 106.78 FEET; THENCE N57°25'41"E A DISTANCE OF 7.74 FEET; THENCE N00°09'44"E A DISTANCE OF 15.84 FEET TO THE POINT OF BEGINNING.

CONTAINING 3,418 SQUARE FEET, MORE OR LESS.

SURVEYOR'S REPORT:

1. THIS LEGAL DESCRIPTION IS NOT VALID UNLESS SIGNED AND EMBOSSED WITH A RAISED SEAL OF A FLORIDA LICENSED SURVEYOR AND MAPPER.
2. THE LIMITS OF THIS UTILITY EASEMENT AREA IS AS DIRECTED BY THE CLIENT.
3. THE LEGAL DESCRIPTION, SHOWN HEREON, WAS PREPARED BY THE SURVEYOR.
4. LANDS, SHOWN HEREON, WERE NOT RESEARCHED BY THIS FIRM FOR OWNERSHIP, EASEMENTS, RIGHT OF WAY OR OTHER MATTERS IN THE PUBLIC RECORDS THAT MAY AFFECT THESE LANDS.
5. BEARINGS SHOWN HEREON ARE BASED ON THE SOUTH RIGHT OF WAY LINE OF LENA STREET, AS BEING NORTH 89°57'30" EAST.
6. BEARINGS AND COORDINATES SHOWN HEREON ARE RELATIVE TO THE FLORIDA STATE PLANE COORDINATE SYSTEM EAST ZONE NORTH AMERICAN DATUM OF 1983/1990 ADJUSTMENT.
7. GRAPHIC SYMBOLS, SHOWN HEREON, MAY NOT BE TO MAP SCALE.
8. LAST DAY IN THE FIELD: APRIL 8, 2014.
9. THIS SKETCH OF DESCRIPTION IS HEREBY CERTIFIED TO: ORANGE COUNTY, FLORIDA AND FIRST AMERICAN TITLE INSURANCE COMPANY.
10. THIS IS NOT A BOUNDARY SURVEY.

SURVEYOR'S CERTIFICATION:

THIS LEGAL DESCRIPTION WAS PREPARED UNDER MY DIRECTION AND IS TRUE AND CORRECT TO THE BEST OF MY KNOWLEDGE AND BELIEF. THIS LEGAL DESCRIPTION WAS PERFORMED IN CONFORMANCE WITH THE "MINIMUM TECHNICAL STANDARDS FOR SURVEYS" AS CONTAINED IN CHAPTER 5J-17, FLORIDA ADMINISTRATIVE CODE, PURSUANT TO FLORIDA STATUTE 472.

William L. Miller 5/28/14
WILLIAM L. MILLER, PLS

DATE

FLORIDA SURVEYOR AND MAPPER LS 5010

BARNES FERLAND AND ASSOCIATES LB 7774

*NOT VALID WITHOUT THE SIGNATURE AND ORIGINAL

RAISED SEAL OF THE FLORIDA LICENSED SURVEYOR AND MAPPER

THIS LEGAL DESCRIPTION CONSISTS OF 2 SHEETS
AND IS NOT COMPLETE WITHOUT SHEET 2 OF 2

REVISED:

5/22/14

PER COMMENTS FROM ORANGE COUNTY

BFA Environmental Consultants
Barnes, Ferland and Associates, Inc.
1230 E. Hillcrest Street, Orlando, FL, 32809
PH: (407) 806-8800 FAX: (407) 806-5800
CERTIFICATE OF AUTHORIZATION: LB7774

LEGAL DESCRIPTION

UTILITY EASEMENT - PUMP STATION 3309
A PORTION OF TRACT A, RIVEN PINES
PB 13, PAGE 12, ORANGE COUNTY, FLORIDA

SHEET
1 OF 2

UTILITY EASEMENT -PUMP STATION 3309

ORANGE COUNTY, FLORIDA
SKETCH OF DESCRIPTION

LEGEND:

- | | |
|-----------------------------|--|
| POB = POINT OF BEGINNING | ☐ = DRAINAGE INLET |
| U.E. = UTILITY EASEMENT | ⊗ = WOOD UTILITY POLE |
| (M) = FIELD MEASUREMENT | ⊖ = GUY ANCHOR |
| POC = POINT OF COMMENCEMENT | ⊕ = ELECTRIC METER |
| LS = LIFT STATION | ⊥ = METAL SIGN |
| PC = POINT OF CURVATURE | ⊠ = ELECTRIC BOX |
| D.E. = DRAINAGE EASEMENT | ● = SET IRON ROD AND CAP STAMPED "LB 7774" |
| PB = PLAT BOOK | ⊙ = FOUND 1/2" IRON REBAR NO ID. |
| (M) = FIELD MEASUREMENT | ⊠ = FOUND 4"x4" CONCRETE (ILLEGIBLE) |
| (P) = PLAT | -OHU- = OVERHEAD UTILITY |
| PG = PAGE | -TV(B)- = CABLE TELEVISION |
| PT = POINT OF TANGENCY | COR-1 = CORNER IDENTIFIER-SEE |
| (C) = CALCULATED | (TYPICAL) COORDINATE TABLE |
| E/P = EDGE OF PAVEMENT | |
| C&G = CURB AND GUTTER | |
| -X- = CHAIN LINK FENCE | |

LENA STREET
(RIGHT OF WAY WIDTH VARIES)

R=25.00'(P)(C)
L=39.27'(P)
39.28'(C)
Δ=90°00'00"(P)
90°01'59"(C)
CB=S45°01'30"E

E/P 2' C&G

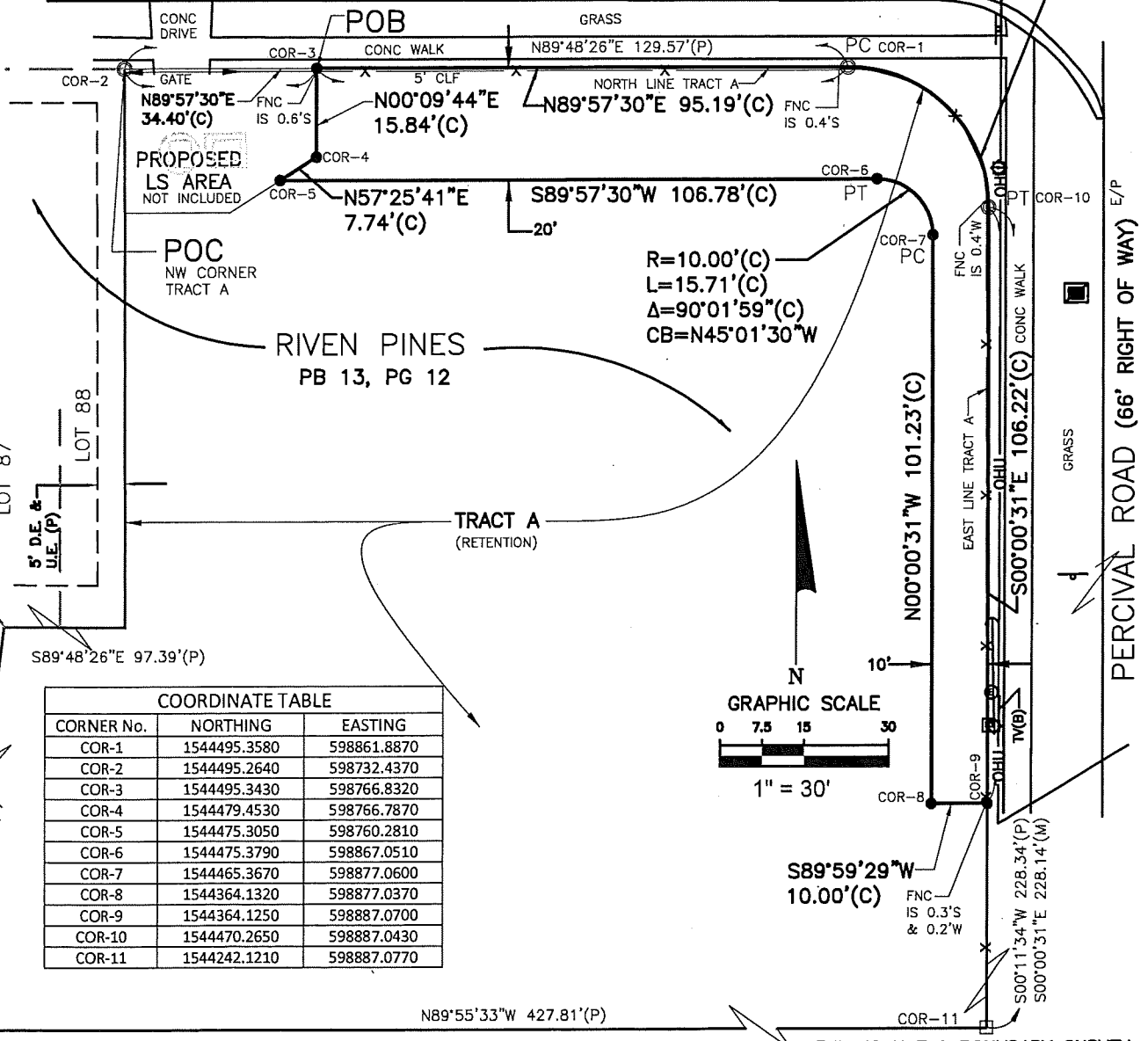

CORNER No.	NORTHING	EASTING
COR-1	1544495.3580	598861.8870
COR-2	1544495.2640	598732.4370
COR-3	1544495.3430	598766.8320
COR-4	1544479.4530	598766.7870
COR-5	1544475.3050	598760.2810
COR-6	1544475.3790	598867.0510
COR-7	1544465.3670	598877.0600
COR-8	1544364.1320	598877.0370
COR-9	1544364.1250	598887.0700
COR-10	1544470.2650	598887.0430
COR-11	1544242.1210	598887.0770

F:\CIVIL\PROJECTS\2011\11-11.13 Package 1 Pump Stations\5.0 Drawings\2011-11.13 Package 1 PS 3309 FM SOD.dwg, 5/27/2014 6:01:15 PM

THIS LEGAL DESCRIPTION CONSISTS OF 2 SHEETS AND IS NOT COMPLETE WITHOUT SHEET 1 OF 2 THIS IS NOT A BOUNDARY SURVEY

BFA Environmental Consultants
Barnes, Ferland and Associates, Inc.
1230 E Hillcrest Street, Orlando, FL, 32803
PH: (407) 806-8000 FAX: (407) 806-1882
CERTIFICATE OF AUTHORIZATION: LB7774

LEGAL DESCRIPTION
UTILITY EASEMENT-PUMP STATION 3309
A PORTION OF TRACT A, RIVEN PINES
PB 13, PAGE 12, ORANGE COUNTY, FLORIDA

SHEET
2 OF 2

PUMP STATION 3365 IMPROVEMENTS BOUNDARY SURVEY

COORDINATE TABLE

CORNER No.	NORTHING	EASTING
COR-1	1549966.0770	583197.9740
COR-2	1549965.8710	583175.4340
COR-3	1549898.5530	583175.4180
COR-4	1549898.7560	583198.5460
COR-7	1549966.3050	583235.2190
COR-8	1549899.2760	583236.3570

UNIVERSITY BLVD
(R/W VARIES)

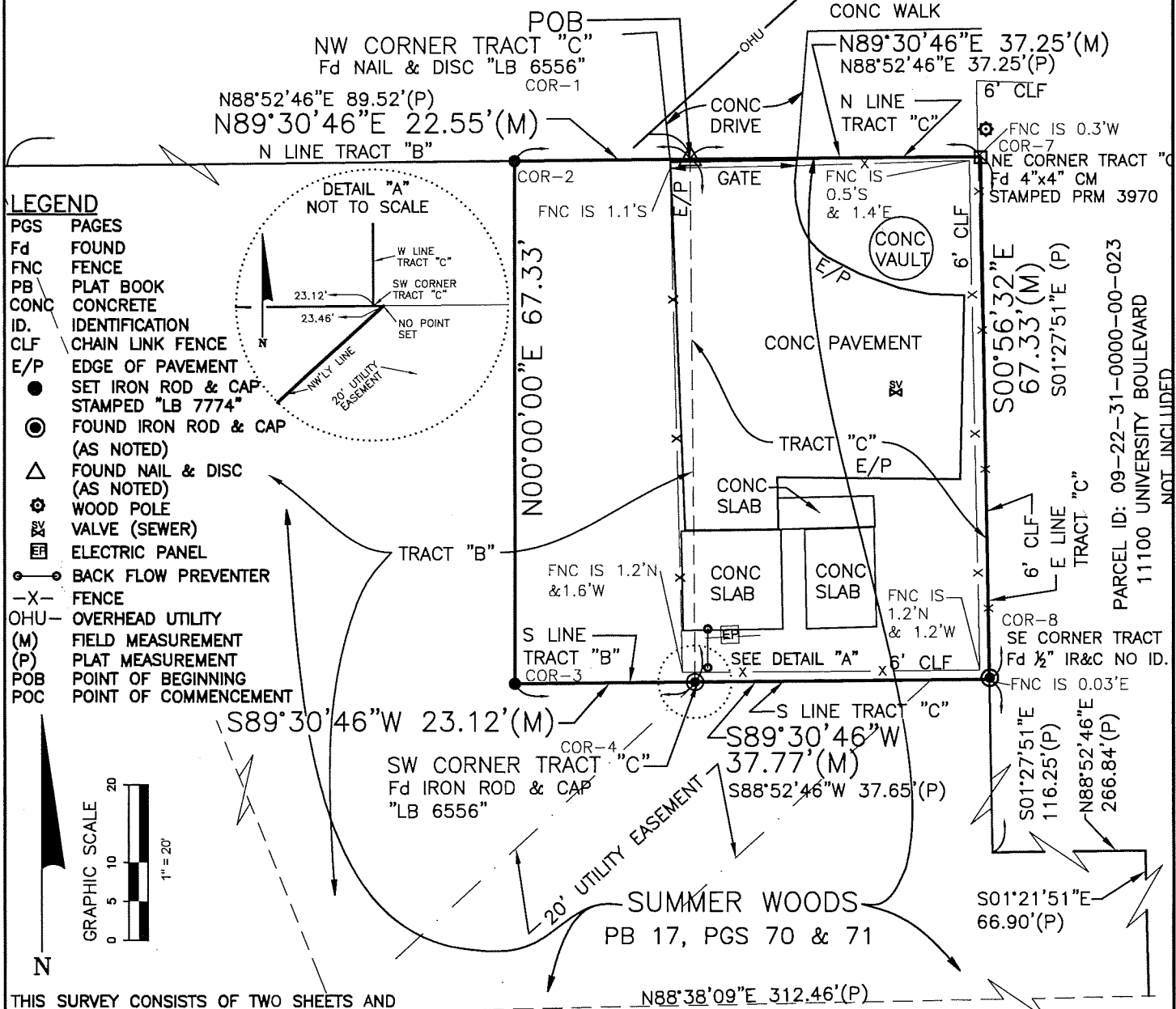

- LEGEND**
- PGS PAGES
 - Fd FOUND
 - FNC FENCE
 - PB PLAT BOOK
 - CONC CONCRETE
 - ID. IDENTIFICATION
 - CLF CHAIN LINK FENCE
 - E/P EDGE OF PAVEMENT
 - SET IRON ROD & CAP STAMPED "LB 7774"
 - ⊙ FOUND IRON ROD & CAP (AS NOTED)
 - △ FOUND NAIL & DISC (AS NOTED)
 - ⊗ WOOD POLE
 - ⊕ VALVE (SEWER)
 - ⊞ ELECTRIC PANEL
 - ⊙ BACK FLOW PREVENTER
 - X- FENCE
 - OHU OVERHEAD UTILITY
 - (M) FIELD MEASUREMENT
 - (P) PLAT MEASUREMENT
 - POB POINT OF BEGINNING
 - POC POINT OF COMMENCEMENT

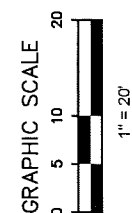
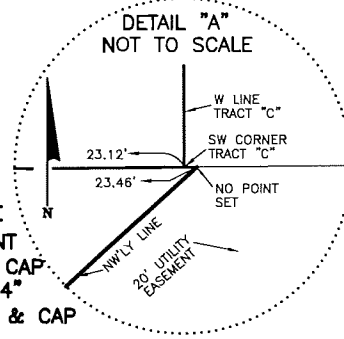

THIS SURVEY CONSISTS OF TWO SHEETS AND IS NOT COMPLETE WITHOUT SHEET 2 OF 2.

PARCEL ID: 09-22-31-0000-00-023
 11100 UNIVERSITY BOULEVARD
 NOT INCLUDED

<p>BFA Environmental Consultants Barnes, Ferland and Associates, Inc. 1230 E. Hillcrest Street, Orlando, FL 32803 PH: (407) 896-8808 FAX: (407) 896-1883 CERTIFICATE OF AUTHORIZATION: LB7774</p>	<p>BOUNDARY SURVEY A PORTION OF TRACT "B" AND TRACT "C", SUMMER WOODS, PB 17, PAGES 70 & 71 11098 UNIVERSITY BOULEVARD</p>	<p>SHEET 2 OF 2</p>
--	---	-------------------------

F:\CIVIL\PROJECTS\2011\11-11.13 Package 1 Pump Stations\5.0 Drawings\2011-11-13 Package 1 PS 3365 Boundary.dwg, 6/2/2014 2:13:54 PM

**PUMP STATION 3365 IMPROVEMENTS
UTILITY EASEMENT**

PARCEL: 801
ESTATE: PERPETUAL EASEMENT
PURPOSE: UTILITY

Legal Description:

A portion of Tract "B", Summer Woods, according to the plat thereof, as recorded in Plat Book 17, page 70 of the public records of Orange County, described as follows:

Commence at the northwest corner of Tract "C" of said Summer Woods for a point of reference; thence run South 89°30'46" West, along the north line of said Tract "B", a distance of 22.55 feet to the Point of Beginning; thence run South 00°00'00" West, 67.33 feet; thence run North 89°30'46" East, 23.46 feet; thence run South 47°33'49" West, along the northwesterly line of an existing utility easement as per said plat, a distance of 53.47 feet; thence run North 00°00'00" East, 103.07 feet to a point on the north line of said Tract "B"; thence run North 89° 30' 46" East, along said north line, a distance of 16.00 feet to the Point of Beginning.

Containing 1,776 square feet, more or less.

Surveyor's Report:

1. This Legal Description is not valid unless signed and embossed with a raised seal of a Florida licensed Surveyor and Mapper.
2. The limits of the Boundary Survey are as directed by the client.
3. The Legal Descriptions, shown hereon, were prepared by the surveyor.
4. Lands, shown hereon, were not researched by this firm for ownership, easements, right of way or other matters in the public records that may affect these lands.
5. Bearings shown hereon are based on the North line of Tract "C", as being North 89°30'46" East.
6. Bearings and coordinates shown hereon are relative to the Florida State Plane Coordinate System, East Zone North American Datum of 1983.
7. Last day in the field: March 17, 2014.
8. Graphic symbols, shown hereon, may not be to map scale.
9. This is not a Boundary Survey.
10. This Sketch of Description is hereby certified to: Orange County, Florida and First American Title Insurance Company.

Surveyor's Certification:

This Legal Description was prepared under my direction and is true and correct to the best of my knowledge and belief. This Legal Description was performed in conformance with the "Minimum Technical Standards for Surveys" as contained in Chapter 5J-17, Florida Administrative Code, pursuant to Florida Statute 472.

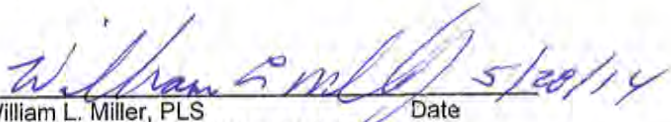
William L. Miller, PLS Date
Florida Surveyor and Mapper LS 5010
Barnes Ferland and Associates LB 7774

*Not valid without the signature and original raised seal of the Florida licensed surveyor and mapper

THIS SKETCH CONSISTS OF TWO SHEETS AND IS NOT COMPLETE WITHOUT SHEET 2 AND 2.

REVISED:
5/27/14

PER COMMENTS FROM ORANGE COUNTY

BFA Environmental Consultants
Barnes, Ferland and Associates, Inc.
1290 E. Hillcrest Street, Orlando, FL, 32803
PH: (407) 894-8808 FAX: (407) 894-1082
CERTIFICATE OF AUTHORIZATION: LB7774

LEGAL DESCRIPTION
TRACT "B", SUMMER WOODS, PB 17, PAGES 70 & 71
11098 UNIVERSITY BOULEVARD

SHEET
1 OF 2

PUMP STATION 3365 IMPROVEMENTS UTILITY EASEMENT SKETCH OF DESCRIPTION

COORDINATE TABLE

CORNER No.	NORTHING	EASTING
COR-1	1549966.0770	583197.9740
COR-2	1549965.8710	583175.4340
COR-3	1549898.5530	583175.4180
COR-4	1549898.7560	583198.5460
COR-5	1549862.6650	583159.4410
COR-6	1549965.7350	583159.4220

UNIVERSITY BLVD
(R/W VARIES)

POC
NW CORNER
TRACT "C"
Fd NAIL & DISC
"LB 6556"

CONC DRIVE

GATE

CONC VAULT

E/P

E/P

E/P

E/P

E/P

E/P

E/P

E/P

E/P

E/P

E/P

E/P

E/P

E/P

E/P

E/P

E/P

E/P

E/P

E/P

E/P

E/P

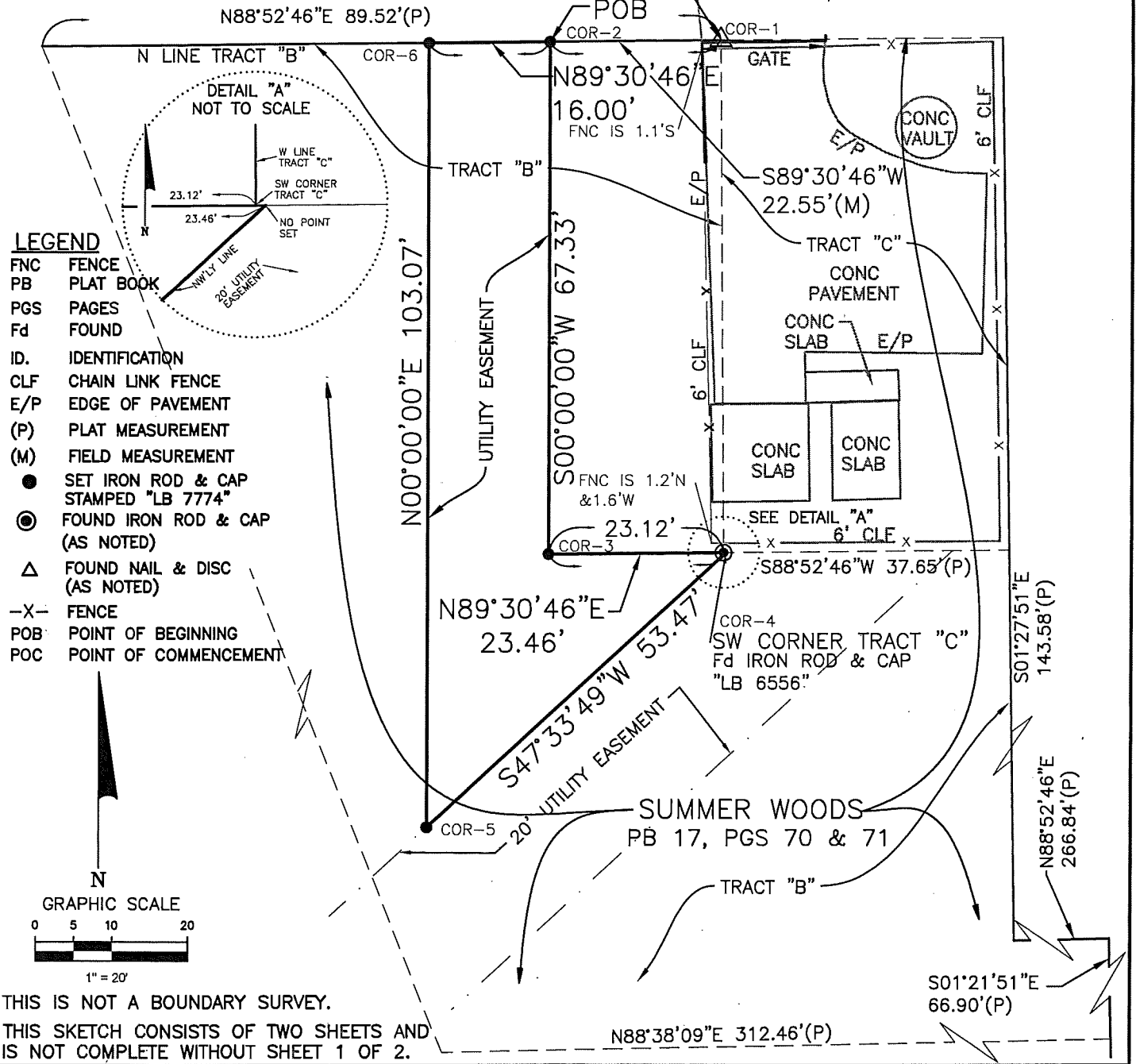

THIS IS NOT A BOUNDARY SURVEY.
THIS SKETCH CONSISTS OF TWO SHEETS AND IS NOT COMPLETE WITHOUT SHEET 1 OF 2.

N88°38'09"E 312.46'(P)

BFA Environmental Consultants
Bernes, Farland and Associates, Inc.
1230 E. Hillcrest Street, Orlando, FL 32803
TEL: (407) 806-0000 FAX: (407) 806-1000
CERTIFICATE OF AUTHORIZATION: LB7774

LEGAL DESCRIPTION
TRACT "B", SUMMER WOODS, PB 17, PAGES 70 & 71
11098 UNIVERSITY BOULEVARD

SHEET
2 OF 2

F:\CIVIL\PROJECTS\2011\2011-11-11.13 Package 1 Pump Stations\5-0 Drawings\2011-11-13 Package 1 PS 3365 UE SOD.dwg, 5/28/2014 12:01:48 PM

BOUNDARY & TOPOGRAPHIC SURVEY

PUMP STATION 3309

LYING IN A PORTION OF
SECTION 14, TOWNSHIP 22 SOUTH, RANGE 31 EAST
ORANGE COUNTY, FLORIDA

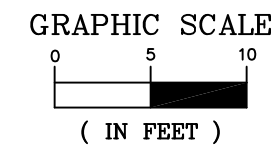

LEGAL DESCRIPTION - PUMP STATION 3309

THE NORTH LINE AND WEST LINE OF TRACT A, RIVEN PINES, ACCORDING TO THE PLAT THEREOF, AS RECORDED IN PLAT BOOK 13, PAGE 12 OF THE PUBLIC RECORDS OF ORANGE COUNTY, FLORIDA.

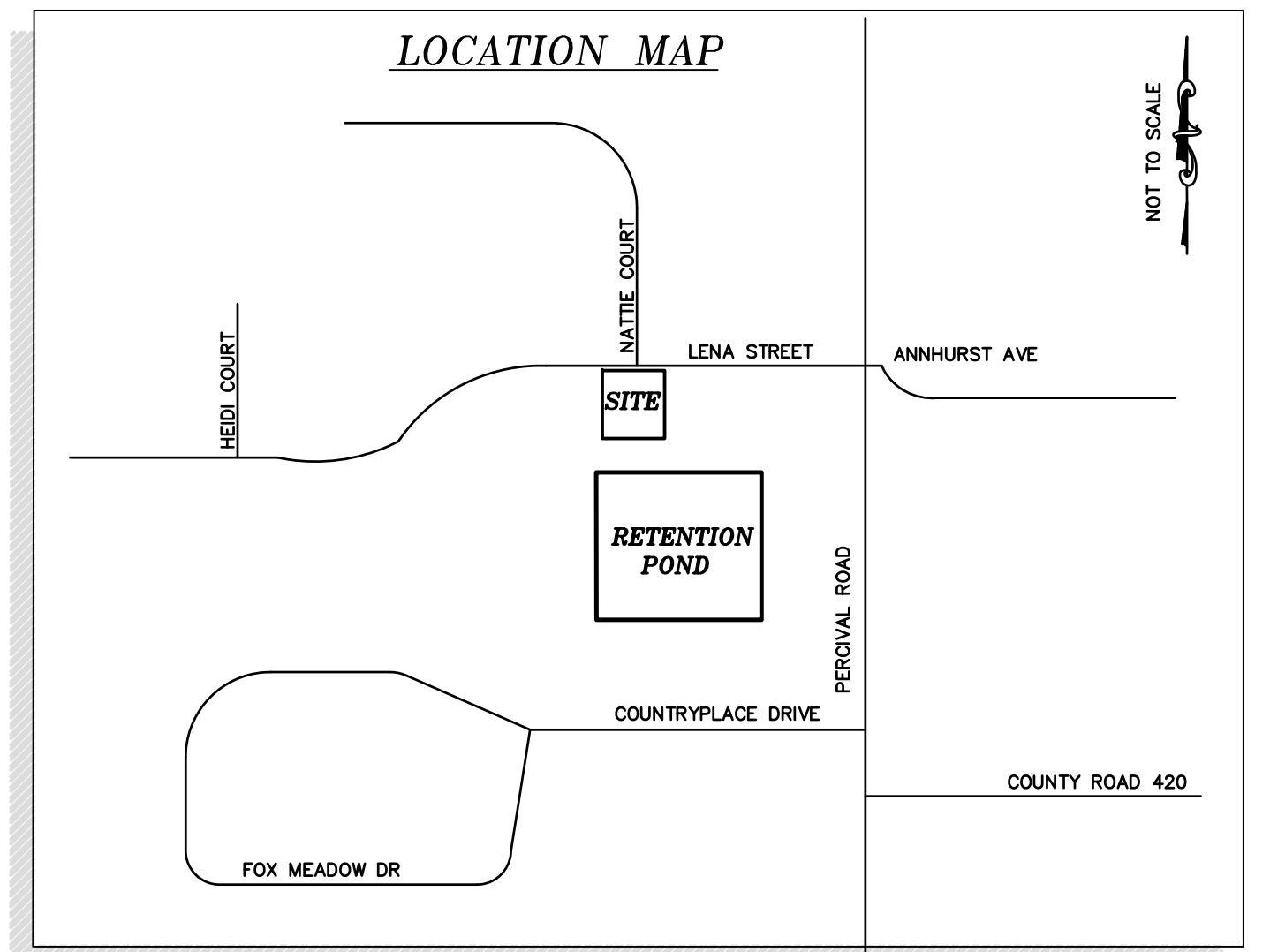
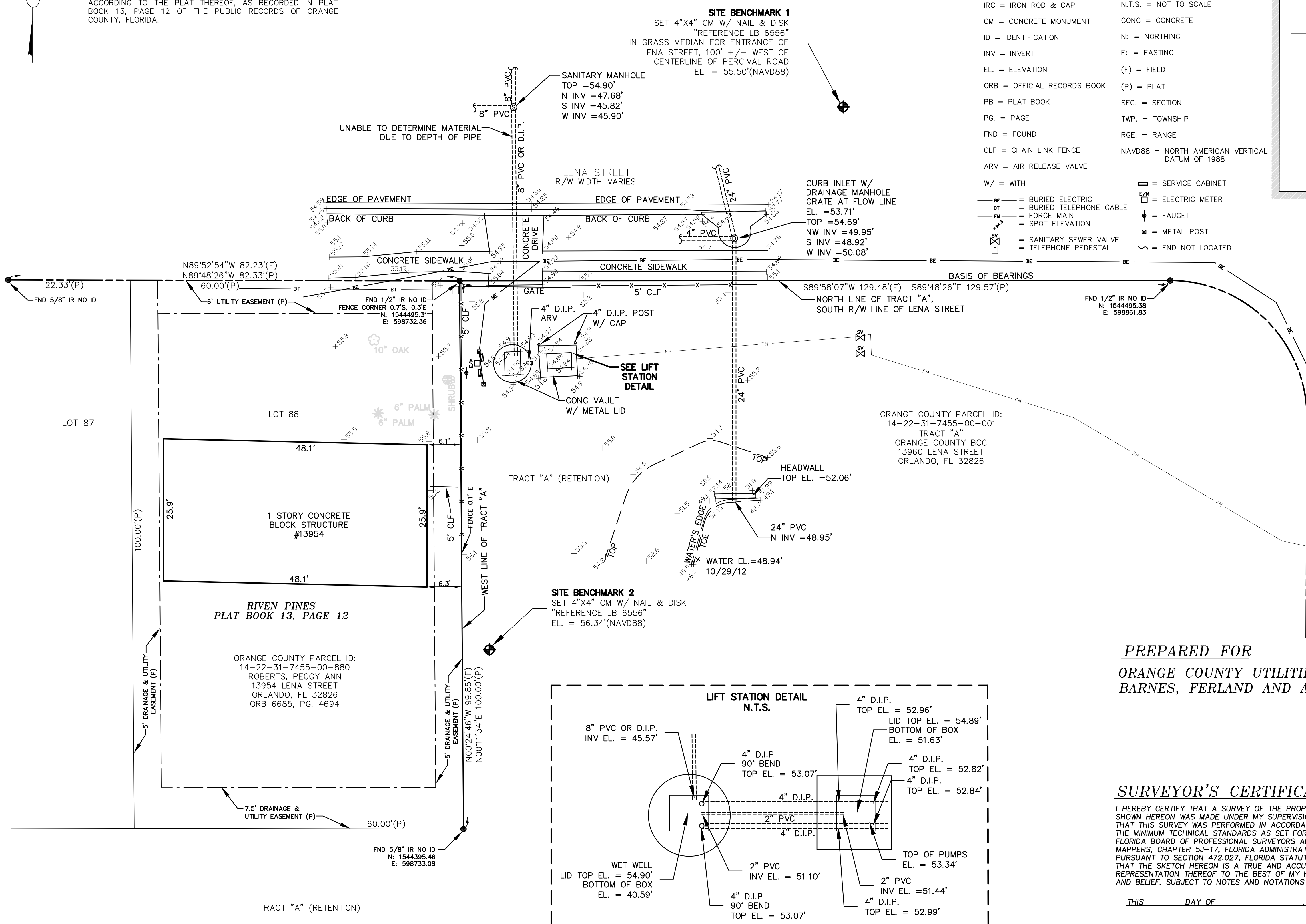

SURVEYOR'S REPORT

- THE PURPOSE OF THIS SURVEY IS TO ESTABLISH THE LIMITS OF THE PROPERTY DESCRIBED IN THE LEGAL DESCRIPTION SHOWN HEREON BY ESTABLISHING OR RE-ESTABLISHING CORNERS, MONUMENTS AND BOUNDARY LINES, AND TO ESTABLISH THE HORIZONTAL AND VERTICAL SPATIAL RELATIONSHIP OF THE NATURAL OR MANMADE FEATURES LYING WITHIN THE DEFINED TOPOGRAPHIC SURVEY LIMITS NOTED BELOW.
- THE LIMITS OF THE TOPOGRAPHIC SURVEY IS THE EXISTING PUMP STATION IMPROVEMENTS AND APPROXIMATELY 25 FEET OUTSIDE OF SAID PUMP STATION.
- BEARINGS AND COORDINATES SHOWN HEREON ARE RELATIVE TO THE FLORIDA STATE PLANE COORDINATE SYSTEM, NORTH AMERICAN DATUM OF 1983/2007 ADJUSTMENT (NAD83/07), ADJUSTMENT, ZONE 901, FLORIDA EAST, WITH THE NORTH LINE OF TRACT A HAVING A BEARING OF SOUTH 89°58'07" WEST.
- ELEVATIONS SHOWN HEREON ARE RELATIVE TO THE NORTH AMERICAN VERTICAL DATUM OF 1988 (NAVD88) AS ESTABLISHED FROM THE FOLLOWING ORANGE COUNTY BENCHMARKS:
C803020
FOUND 2" ORANGE COUNTY BRASS CONTROL DISC IN NORTH CENTER OF DROP INLET ON WEST SIDE PERCIVAL ROAD, SOUTH OF LAKE PICKETT ROAD
PUBLISHED ELEVATION = 51.105 FEET (NAVD88)
L1090066
FOUND 2 1/4" ORANGE COUNTY BRASS CONTROL DISC IN HEAD WALL +/- 30 FEET EAST OF C/L OF PERCIVAL ROAD. ACROSS FROM ADDRESS 2822
PUBLISHED ELEVATION = 57.387 FEET (NAVD88)
- THE SURVEYOR HAS NOT ABSTRACTED THE LANDS SHOWN HEREON FOR EASEMENTS AND/OR RIGHT-OF-WAY RECORDS. THIS SURVEY WAS PREPARED WITHOUT THE BENEFIT OF A TITLE REPORT.
- THE LOCATION OF UNDERGROUND UTILITY LINES SHOWN HEREON WERE DETERMINED BY A COMBINATION OF PHYSICAL MARKING MADE BY THE UTILITY COMPANIES IN RESPONSE TO CALL SUNSHINE LOCATE REQUEST, TICKET NUMBER 271206677, FIELD MARKINGS BY BARNES, FERLAND AND ASSOCIATES INC., AND BY EXAMINATION OF SURFACE APPURTENANCES OF SAID UTILITIES. NO UNDERGROUND INSTALLATIONS OR IMPROVEMENTS HAVE BEEN LOCATED EXCEPT AS SHOWN.
- ALL RECORDING REFERENCES SHOWN ON THIS SURVEY REFER TO THE PUBLIC RECORDS OF ORANGE COUNTY, FLORIDA, UNLESS OTHERWISE NOTED.
- UNLESS IT BEARS THE SIGNATURE AND THE ORIGINAL RAISED SEAL OF A FLORIDA LICENSED SURVEYOR AND MAPPER THIS DRAWING, SKETCH, PLAT, OR MAP IS FOR INFORMATIONAL PURPOSES ONLY AND IS NOT VALID.
- ACCORDING TO THE FLOOD INSURANCE RATE MAP (FIRM), DATED SEPTEMBER 25, 2009 THE SURVEY LIMITS SHOWN HEREON APPEARS TO BE IN FLOOD "ZONE X". AREAS DETERMINED TO BE OUTSIDE THE 0.2% ANNUAL CHANCE FLOODPLAIN, AS LOCATED ON COMMUNITY PANEL NO. 120179-0285-F, MAP NUMBER 12095C0285F.

PREPARED FOR
ORANGE COUNTY UTILITIES
BARNES, FERLAND AND ASSOCIATES, INC.

SURVEYOR'S CERTIFICATION

I HEREBY CERTIFY THAT A SURVEY OF THE PROPERTY SHOWN HEREON WAS MADE UNDER MY SUPERVISION AND THAT THIS SURVEY WAS PERFORMED IN ACCORDANCE WITH THE MINIMUM TECHNICAL STANDARDS AS SET FORTH BY THE FLORIDA BOARD OF PROFESSIONAL SURVEYORS AND MAPPERS, CHAPTER 5J-17, FLORIDA ADMINISTRATIVE CODE, PURSUANT TO SECTION 472.027, FLORIDA STATUTES AND THAT THE SKETCH HEREON IS A TRUE AND ACCURATE REPRESENTATION HEREOF TO THE BEST OF MY KNOWLEDGE AND BELIEF. SUBJECT TO NOTES AND NOTATIONS SHOWN

THIS DAY OF 20

H. Paul deVivero, Professional Land Surveyor No. 4990
Land Surveyor Business License No. 6556
VALID ONLY WITH SIGNATURE AND EMBOSSED SEAL

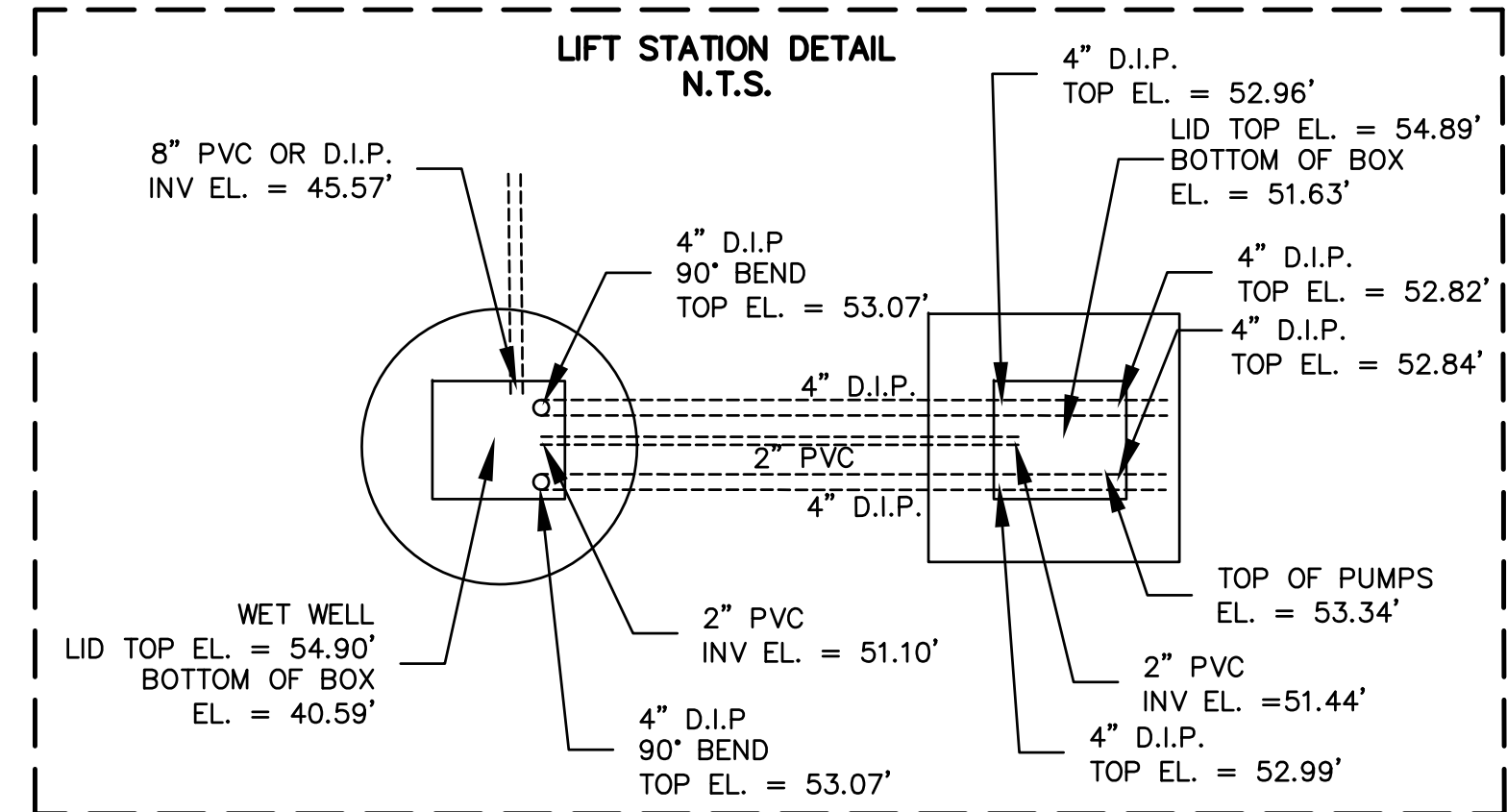

GEODATA CONSULTANTS, INC. SURVEYING & MAPPING 2700 WESTHALL LANE SUITE 137 MAITLAND, FLORIDA 32751 VOICE: (407) 660-2322 FAX: 660-8223		DRAWN BY: DPW	CHECKED BY: RHJ/IMS
		DATE OF FIELD SURVEY: OCTOBER 29, 2012	FIELD BOOK NUMBER: 18-06; PAGES 24-43
		SEC. 14, TWP. 22 S., RGE. 31 E.	ORANGE COUNTY, FLORIDA
No.	DATE	REVISION	DATE: OCTOBER 30, 2012 SCALE: 1" = 10'
			PROJECT No. SHEET 1
			B18-14 OF 1

BOUNDARY & TOPOGRAPHIC SURVEY

PUMP STATION 3365

LYING IN A PORTION OF
SECTION 9, TOWNSHIP 22 SOUTH, RANGE 31 EAST
ORANGE COUNTY, FLORIDA

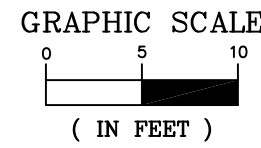

LEGAL DESCRIPTION - PUMP STATION 3365

TRACT C, SUMMER WOODS, ACCORDING TO THE PLAT THEREOF, AS RECORDED IN PLAT BOOK 17, PAGES 70 THROUGH 71 OF THE PUBLIC RECORDS OF ORANGE COUNTY, FLORIDA.

SANITARY MANHOLE
TOP = 52.13'
NE INV = 37.59'
S INV = 37.27'
W INV = 37.29'

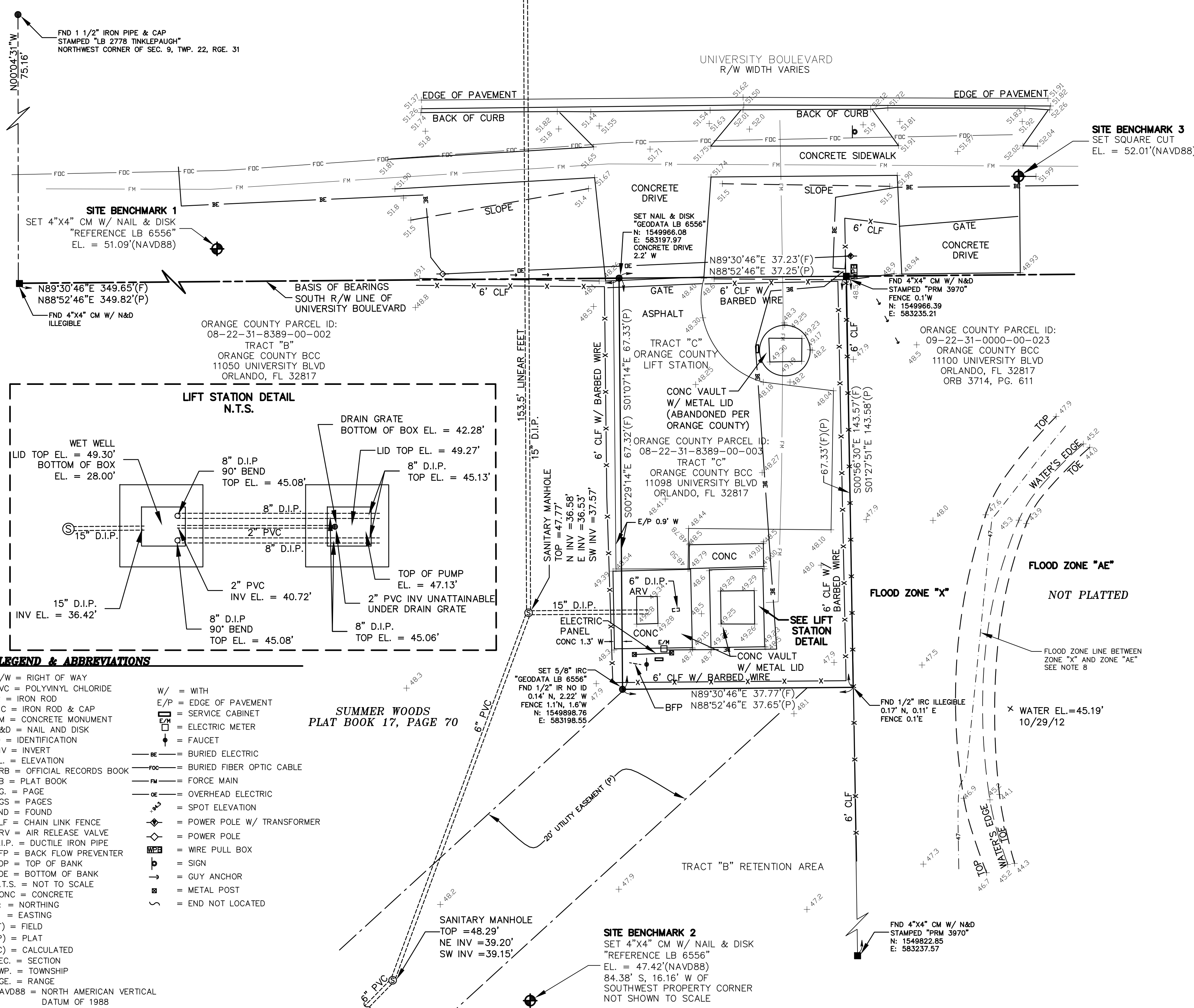

LIFT STATION DETAIL N.T.S.

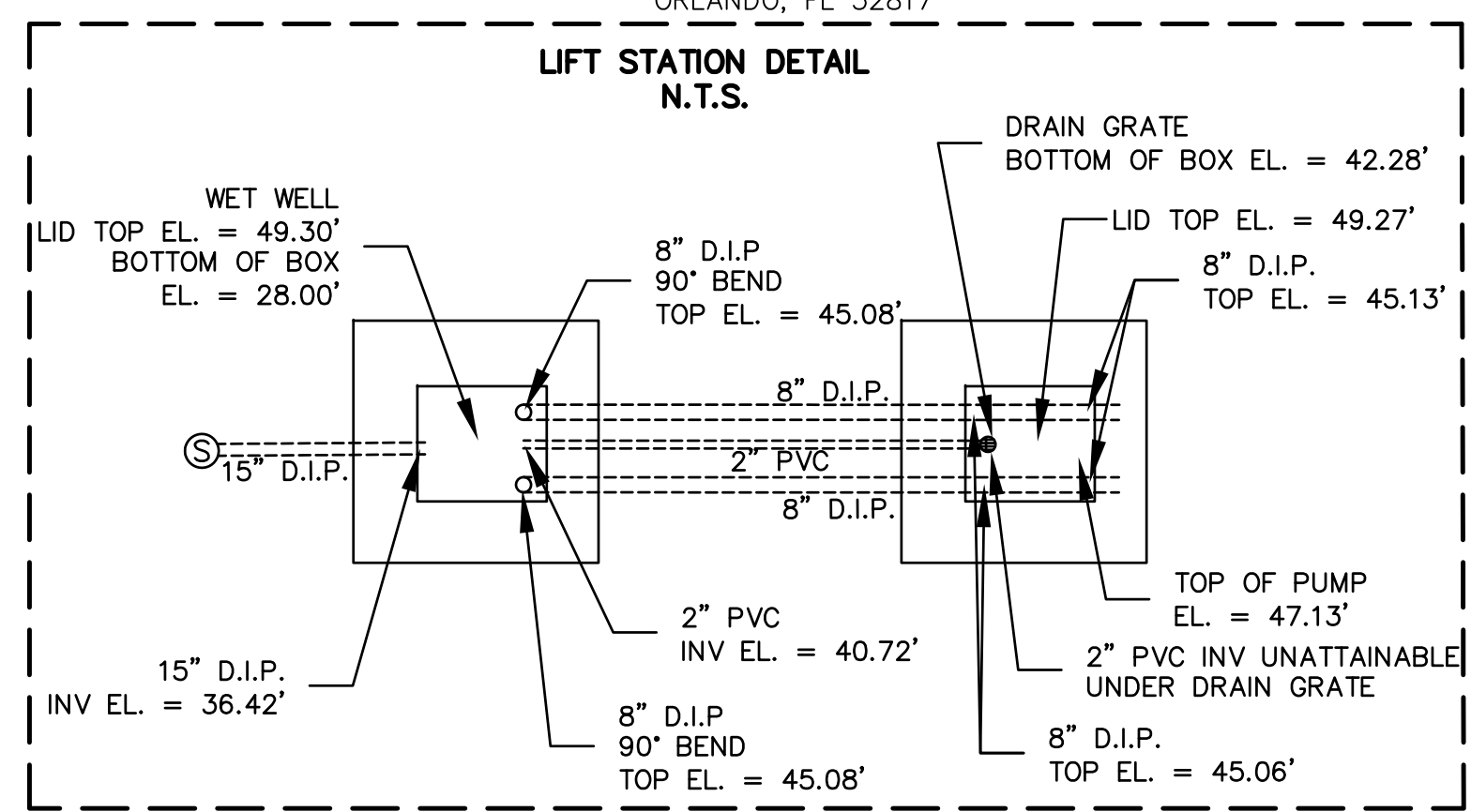

LEGEND & ABBREVIATIONS

- R/W = RIGHT OF WAY
- PVC = POLYVINYL CHLORIDE
- IR = IRON ROD
- IRC = IRON ROD & CAP
- CM = CONCRETE MONUMENT
- N&D = NAIL AND DISK
- ID = IDENTIFICATION
- INV = INVERT
- EL. = ELEVATION
- ORB = OFFICIAL RECORDS BOOK
- PB = PLAT BOOK
- PG. = PAGE
- PGS. = PAGES
- FND = FOUND
- CLF = CHAIN LINK FENCE
- ARV = AIR RELEASE VALVE
- D.I.P. = DUCTILE IRON PIPE
- BFP = BACK FLOW PREVENTER
- TOP = TOP OF BANK
- TOE = BOTTOM OF BANK
- CONC = CONCRETE
- N. = NORTHING
- E. = EASTING
- (F) = FIELD
- (P) = PLAT
- (C) = CALCULATED
- SEC. = SECTION
- TWP. = TOWNSHIP
- RGE. = RANGE
- NAVD88 = NORTH AMERICAN VERTICAL DATUM OF 1988
- W/ = WITH
- E/P = EDGE OF PAVEMENT
- S/C = SERVICE CABINET
- EM = ELECTRIC METER
- FAUCET
- BE = BURIED ELECTRIC
- FOC = BURIED FIBER OPTIC CABLE
- FM = FORCE MAIN
- OE = OVERHEAD ELECTRIC
- SE = SPOT ELEVATION
- PP = POWER POLE W/ TRANSFORMER
- PP = POWER POLE
- WPB = WIRE PULL BOX
- SIGN
- GA = GUY ANCHOR
- MP = METAL POST
- ENL = END NOT LOCATED

SUMMER WOODS
PLAT BOOK 17, PAGE 70

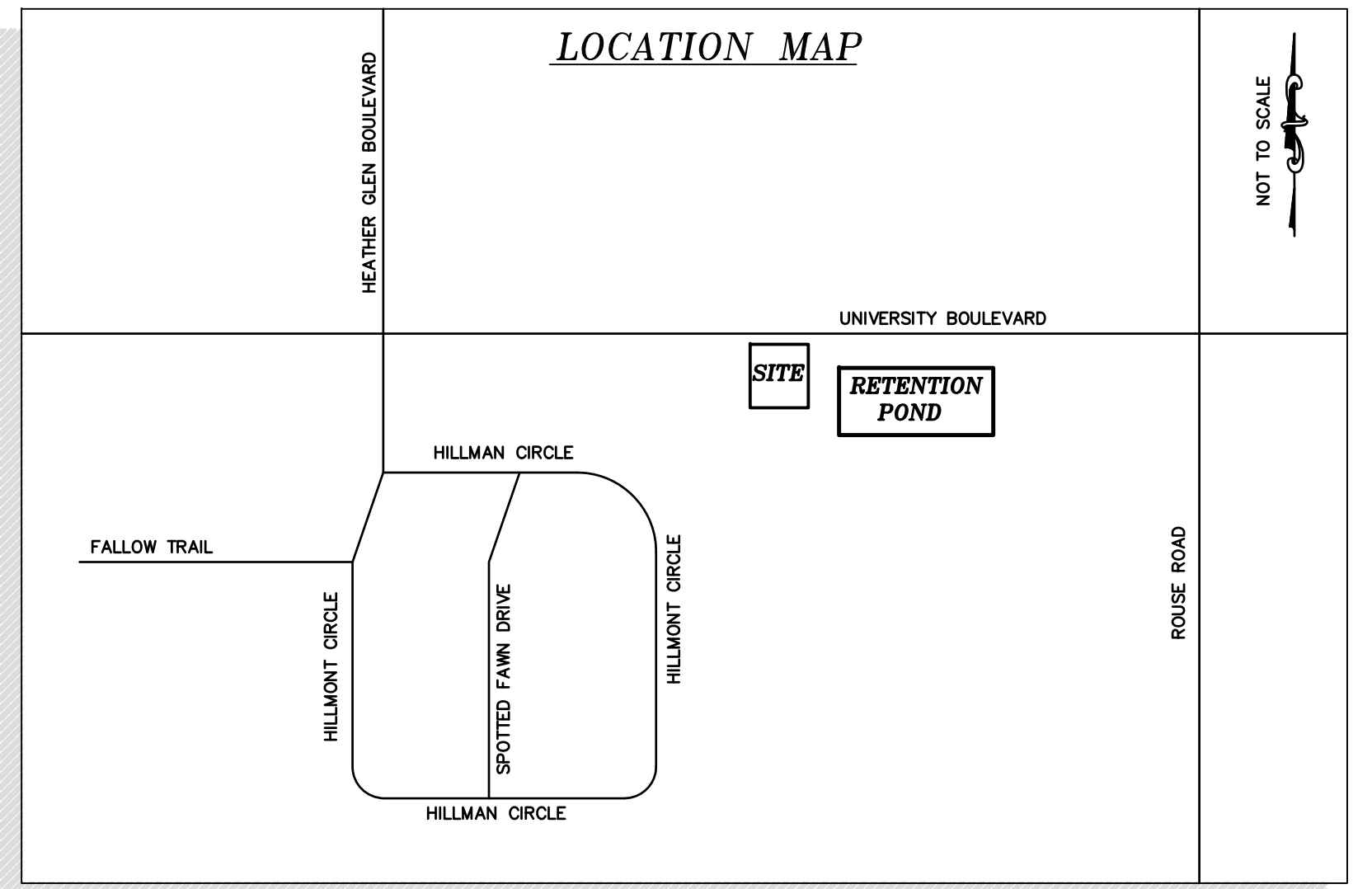

SURVEYOR'S REPORT

- THE PURPOSE OF THIS SURVEY IS TO ESTABLISH THE LIMITS OF THE PROPERTY DESCRIBED IN THE LEGAL DESCRIPTION SHOWN HEREON BY ESTABLISHING OR RE-ESTABLISHING CORNERS, MONUMENTS AND BOUNDARY LINES, AND TO ESTABLISH THE HORIZONTAL AND VERTICAL SPATIAL RELATIONSHIP OF THE NATURAL OR MANMADE FEATURES LYING WITHIN THE DEFINED TOPOGRAPHIC SURVEY LIMITS NOTED BELOW.
- THE LIMITS OF THE TOPOGRAPHIC SURVEY IS THE EXISTING PUMP STATION PARCEL LOCATED ON UNIVERSITY BOULEVARD AND APPROXIMATELY 25 FEET OUTSIDE OF EXISTING BOUNDARY LIMITS.
- BEARINGS AND COORDINATES SHOWN HEREON ARE RELATIVE TO THE FLORIDA STATE PLANE COORDINATE SYSTEM, NORTH AMERICAN DATUM OF 1983/2007 ADJUSTMENT (NAD83/07), ADJUSTMENT, ZONE 901, FLORIDA EAST, WITH THE SOUTH RIGHT OF WAY LINE OF UNIVERSITY BOULEVARD HAVING A BEARING OF NORTH 89°30'46" EAST.
- ELEVATIONS SHOWN HEREON ARE RELATIVE TO THE NORTH AMERICAN VERTICAL DATUM OF 1988 (NAVD88) AS ESTABLISHED FROM THE FOLLOWING ORANGE COUNTY BENCHMARKS:
 - L1010008 FOUND 2 1/2" ORANGE COUNTY BRASS CONTROL DISC IN CURB-INLET, NORTHEAST SIDE OF CURB-INLET AND ON SOUTHWEST CORNER OF HILLMONT CR. AND SEPTER DR. PUBLISHED ELEVATION = 55.353 FEET (NAVD88)
 - L1010006 FOUND 2 1/2" ORANGE COUNTY BRASS CONTROL DISC IN EAST SIDE OF CURB-INLET ON THE EAST SIDE OF HEATHER GLEN, +/- 400 FT NORTH OF C/L OF UNIVERSITY BLVD. AND +/- 30 FT EAST OF C/L OF HEATHER GLEN PUBLISHED ELEVATION = 53.118 FEET (NAVD88)
- THE SURVEYOR HAS NOT ABSTRACTED THE LANDS SHOWN HEREON FOR EASEMENTS AND/OR RIGHT-OF-WAY RECORDS. THIS SURVEY WAS PREPARED WITHOUT THE BENEFIT OF A TITLE REPORT.
- THE LOCATION OF UNDERGROUND UTILITY LINES SHOWN HEREON WERE DETERMINED BY A COMBINATION OF PHYSICAL MARKING MADE BY THE UTILITY COMPANIES IN RESPONSE TO CALL SUNSHINE LOCATE REQUEST, TICKET NUMBER 271206813, FIELD MARKINGS BY BARNES, FERLAND AND ASSOCIATES, INC. AND BY EXAMINATION OF SURFACE APPURTENANCES OF SAID UTILITIES. NO UNDERGROUND INSTALLATIONS OR IMPROVEMENTS HAVE BEEN LOCATED EXCEPT AS SHOWN.
- ALL RECORDING REFERENCES SHOWN ON THIS SURVEY REFER TO THE PUBLIC RECORDS OF ORANGE COUNTY, FLORIDA, UNLESS OTHERWISE NOTED.
- UNLESS IT BEARS THE SIGNATURE AND THE ORIGINAL RAISED SEAL OF A FLORIDA LICENSED SURVEYOR AND MAPPER THIS DRAWING, SKETCH, PLAT, OR MAP IS FOR INFORMATIONAL PURPOSES ONLY AND IS NOT VALID.
- ACCORDING TO THE FLOOD INSURANCE RATE MAP (FIRM), DATED SEPTEMBER 25, 2009 THE SURVEY LIMITS SHOWN HEREON APPEARS TO LIE IN FLOOD ZONE "X", AREAS DETERMINED TO BE OUTSIDE THE 0.2% ANNUAL CHANCE FLOODPLAIN, AS LOCATED ON COMMUNITY PANEL NO. 120179-0280-F, MAP NUMBER 120950280F, FLOOD ZONE "AE" (BASE FLOOD ELEVATION OF 47 FEET, NORTH AMERICAN VERTICAL DATUM OF 1988, IS SHOWN HEREON. FOR REFERENCE PURPOSES ONLY.

PREPARED FOR
ORANGE COUNTY UTILITIES
BARNES, FERLAND AND ASSOCIATES, INC.

SURVEYOR'S CERTIFICATION

I HEREBY CERTIFY THAT A SURVEY OF THE PROPERTY SHOWN HEREON WAS MADE UNDER MY SUPERVISION AND THAT THIS SURVEY WAS PERFORMED IN ACCORDANCE WITH THE MINIMUM TECHNICAL STANDARDS AS SET FORTH BY THE FLORIDA BOARD OF PROFESSIONAL SURVEYORS AND MAPPERS, CHAPTER 5J-17, FLORIDA ADMINISTRATIVE CODE, PURSUANT TO SECTION 472.027, FLORIDA STATUTES AND THAT THE SKETCH HEREON IS A TRUE AND ACCURATE REPRESENTATION THEREOF TO THE BEST OF MY KNOWLEDGE AND BELIEF. SUBJECT TO NOTES AND NOTATIONS SHOWN

THIS DAY OF _____, 20____

H. Paul deVivero, Professional Land Surveyor No. 4990
Land Surveyor Business License No. 6556
VALID ONLY WITH SIGNATURE AND EMBOSSED SEAL

		DRAWN BY: DPW CHECKED BY: RHJ/IMS		
SURVEYING & MAPPING 2700 WESTHALL LANE SUITE 137 MAITLAND, FLORIDA 32751 VOICE: (407) 660-2322 FAX: 660-8223		DATE OF FIELD SURVEY: OCTOBER 29, 2012 FIELD BOOK NUMBER: 18-06; PAGES 24-43 SEC. 9, TWP. 22 S., RGE. 31 E. ORANGE COUNTY, FLORIDA		
No.	DATE	REVISION	DATE	SCALE
			OCTOBER 30, 2012	1" = 10'
			PROJECT No.	SHEET
			B18-14	OF 1

APPENDIX G

ORANGE COUNTY UTILITIES

DEWATERING DISCHARGE OFF-SITE

- **Orange County Environmental Protection Division Work Instruction**
- **Generic Permit for the Discharge of Produced Ground Water From any Non-Contaminated Site Activity**
- **FDEP Notice of New Method for Mercury Testing**
- **Memo – EPA - Analytical Methods for Mercury in NPDES Permits**

**ORANGE COUNTY ENVIRONMENTAL PROTECTION DIVISION
WORK INSTRUCTION**

Title: Dewatering Permitting and Approvals Work Instruction
Number: EPD-WI-2000-04

Effective Date: 10/04/2011 Revision: 1
Renewal Date: 10/04/2014 Revision Date: 10/04/2011
Approved By: Elizabeth R. Johnson, Environmental Programs Administrator

Purpose: The purpose of this work instruction is to provide guidance regarding the approvals required to initiate construction related dewatering in unincorporated Orange County

I. Procedure

County Offices:

Orange County Public Works

For proposed dewatering discharges to the Orange County Municipal Separate Storm Sewer System (MS4), contact Orange County Development Engineering prior to commencement of dewatering. OC Public Works Contact: Miguel Tamayo, 407-836-7914.

Orange County Utilities (OCU)

If the groundwater discharge testing indicates groundwater quality parameter exceedences, the discharge may be allowed to enter into the Orange County sanitary system. Coordinate with OCU. If OCU can accept the discharge, a County Industrial Wastewater Discharge Permit (IWD) will be required. Per Florida Department of Environmental Protection (FDEP), no FDEP dewatering permitting is required if an IWD is received.

Contact: Susanna Littell, OCU/Water Reclamation, 407-254-7710 (Industrial Wastewater Discharge Permits)

Contact: Laura Woodbury, P.E., OCU/Development Engineering, 407-254-9928.

Rules/Permits:

- Chapter 37 Article XX. Addresses industrial waste pretreatment and permitting.
- Industrial Wastewater Discharge (IWD) Permit. Required prior to discharge to the wastewater system.
- OCU Development Engineering Connection Requirements. OCU Development Engineering reviews and approves plans for groundwater dewatering and remediation projects when discharge will be to the OCU sanitary sewer system.

EPD-WI-2000-04	Effective Date: 10/04/2011
The only official copy of this document is on the EPD intranet.	Page 1 of 3

**ORANGE COUNTY ENVIRONMENTAL PROTECTION DIVISION
WORK INSTRUCTION**

State Agencies:

Florida Department of Environmental Protection (FDEP)

For dewatering that is discharged offsite, sampling/analytical work is required prior to dewatering to determine if the proposed activity can be permitted under one of the generic dewatering permits.

FDEP Contacts: Ali Kazi, 407-897-4149; Randall Cunningham, 407-897-4152.

Rules/Permits:

- Generic Permit for Discharges from Petroleum Contaminated Sites (62-621.300(1)).
- Generic Permit for the Discharge of Produced Groundwater from any Non-Contaminated Site Activity (62-621.300(2)).
- Permit for all Other Contaminated Sites (62-04; 62-302; 62-620 & 62-660).

Water Management Districts:

St. Johns River Water Management District

Contact: Richard Kimmel, 407-659-4849.

Rules/Permits:

- No permit ("No Notice").
- Noticed General Permit for Short-term Construction Dewatering.
- Individual and Standard General Consumptive Use Permit.

South Florida Water Management District

Contact: Mario Cabana, 407-858-6100, ext. 3816.

Rules/Permits:

- "No-Notice" Short-Term Dewatering Permits.
- Dewatering General Water Use Permits.
- Long-term Dewatering Individual Permits.

For dewatering activities located in the City of Orlando contact Lisa Lotti at 407-246-2037.

II. Scope

This procedure applies to construction sites within unincorporated Orange County.

Definitions:

Off-site: For the purposes of this Work Instruction, off-site means property not under control of the owner/applicant or (discharging to) the municipal separate storm sewer system or waters of the County.

EPD-WI-2000-04	Effective Date: 10/04/2011
The only official copy of this document is on the EPD intranet.	Page 2 of 3

STATE OF FLORIDA

DEPARTMENT OF ENVIRONMENTAL PROTECTION

GENERIC PERMIT

FOR THE

DISCHARGE OF PRODUCED GROUND WATER

FROM ANY NON-CONTAMINATED SITE ACTIVITY

Generic Permit for the Discharge of Produced Ground Water from any Non-Contaminated Site Activity

(1) The facility is authorized to discharge produced ground water from any non-contaminated site activity which discharges by a point source to surface waters of the State, as defined in Chapter 62-620, F.A.C., only if the reported values for the parameters listed in Table 1 do not exceed any of the listed screening values. Before discharge of produced ground water can occur from such sites, analytical tests on samples of the proposed untreated discharge water shall be performed to determine if contamination exists.

(2) Minimum reporting requirements for all produced ground water dischargers. The effluent shall be sampled before the commencement of discharge, again within thirty (30) days after commencement of discharge, and then once every six (6) months for the life of the project to maintain continued coverage under this generic permit. Samples taken in compliance with the provisions of this permit shall be taken prior to actual discharge or mixing with the receiving waters. The effluent shall be sampled for the parameters listed in Table 1.

Table 1

Parameter	Screening Values for Discharges into:	
	Fresh Waters	Coastal Waters
Total Organic Carbon (TOC)	10.0 mg/l	10.0 mg/l
pH, standard units	6.0-8.5	6.5-8.5
Total Recoverable Mercury	0.012 µg/l	0.025 µg/l
Total Recoverable Cadmium	9.3 µg/l	9.3 µg/l
Total Recoverable Copper	2.9 µg/l	2.9 µg/l
Total Recoverable Lead	0.03 mg/l	5.6 µg/l
Total Recoverable Zinc	86.0 µg/l	86.0 µg/l
Total Recoverable Chromium (Hex.)	11.0 µg/l	50.0 µg/l
Benzene	1.0 µg/l	1.0 µg/l
Naphthalene	100.0 µg/l	100.0 µg/l

(3) If any of the analytical test results exceed the screening values listed in Table 1, except TOC, the discharge is not authorized by this permit.

(a) For initial TOC values that exceed the screening values listed in Table 1, which may be caused by naturally-occurring, high molecular weight organic compounds, the permittee may request to be exempted from the TOC requirement. To request this exemption, the permittee shall submit additional information with a Notice of Intent (NOI),

described below, which describes the method used to determine that these compounds are naturally occurring. The Department shall grant the exemption if the permittee affirmatively demonstrates that the TOC values are caused by naturally-occurring, high molecular weight organic compounds.

(b) The NOI shall be submitted to the appropriate Department district office thirty (30) days prior to discharge, and contain the following information:

1. the name and address of the person that the permit coverage will be issued to;
2. the name and address of the facility, including county location;
3. any applicable individual wastewater permit number(s);
4. a map showing the facility and discharge location (including latitude and longitude);
5. the name of the receiving water; and
6. the additional information required by paragraph (3)(a) of this permit.

(c) Discharge shall not commence until notification of coverage is received from the Department.

(4) For fresh waters and coastal waters, the pH of the effluent shall not be lowered to less than 6.0 units for fresh waters, or less than 6.5 units for coastal waters, or raised above 8.5 units, unless the permittee submits natural background data confirming a natural background pH outside of this range. If natural background of the receiving water is determined to be less than 6.0 units for fresh waters, or less than 6.5 units in coastal waters, the pH shall not vary below natural background or vary more than one (1) unit above natural background for fresh and coastal waters. If natural background of the receiving water is determined to be higher than 8.5 units, the pH shall not vary above natural background or vary more than one (1) unit below natural background of fresh and coastal waters. The permittee shall include the natural background pH of the receiving waters with the results of the analyses required under paragraph (2) of this permit. For purposes of this section only, fresh waters are those having a chloride concentration of less than 1500 mg/l, and coastal waters are those having a chloride concentration equal to or greater than 1500 mg/l.

(5) In accordance with Rule 62-302.500(1)(a-c), F.A.C., the discharge shall at all times be free from floating solids, visible foam, turbidity, or visible oil in such amounts as to form nuisances on surface waters.

(6) If contamination exists, as indicated by the results of the analytical tests required by paragraph (2), the discharge cannot be covered by this generic permit. The facility shall apply for an individual wastewater permit at least ninety (90) days prior to the date discharge to surface waters of the State is expected, or, if applicable, the facility may seek coverage under any other applicable Department generic permit. No discharge is permissible without an effective permit.

(7) If the analytical tests required by paragraph (2) reveal that no contamination exists from any source, the facility can begin discharge immediately and is covered by this permit without having to submit an NOI request for coverage to the Department. A short summary of the proposed activity and copy of the analytical tests shall be sent to the applicable Department district office within one (1) week after discharge begins. These analytical tests shall be kept on site during discharge and made available to the Department if requested. Additionally, no Discharge Monitoring Report forms are required to be submitted to the Department.

(8) All of the general conditions listed in Rule 62-621.250, F.A.C., are applicable to this generic permit.

(9) There are no annual fees associated with the use of this generic permit.



Department of Environmental Protection

Notice of New Method for Mercury Testing

New Method for Mercury Testing Has Been Approved

In accordance with Rule 62-620.610, Florida Administrative Code (F.A.C.), all sampling and monitoring data, required to be reported to the Department, shall be collected and analyzed in accordance with Rule 62-4.246, Chapters 62-160 and 62-601, F.A.C., and 40 CFR 136, as appropriate. Effective August 25, 2003, Chapter 62-620, F.A.C., was revised to adopt, and incorporate by reference, various sections of Title 40 of the Code of Federal Regulations revised as of July 1, 2003, including the revised 40 CFR 136. The revised 40 CFR 136 includes a new method for low-level mercury analysis, EPA Method 1631(Revision E), Mercury in Water by Oxidation, Purge and Trap, and Cold Vapor Atomic Fluorescence Spectrometry (Method 1631E).

Who is Required to Use Method 1631E?

Applicants for a wastewater facility permit and wastewater facility permittees are now required to use the low-level mercury Method 1631E when reporting results associated with water quality standards (WQSS) below 0.2 micrograms per liter (ug/L). The following facilities are now required to use Method 1631E for all **effluent samples**:

- Facilities discharging to Class I and Class II surface waters, including wetlands.
- Facilities discharging to Class III Marine or Fresh surface waters, including wetlands.
- Facilities with Water Quality Based Effluent Limits (WQBELs), or any other limit for mercury specified in a permit, below 0.2 ug/L.

This includes effluent samples collected for any of the following requirements:

- Monitoring specified in Section I, *Reclaimed Water and Effluent Limitations and Monitoring*, section of permits.
- Monitoring performed under Section 3.A. of *Wastewater Permit Application Form 2A For Domestic Wastewater Facilities*; Part VII.C. of *Application to Discharge Process Wastewater from New or Existing Industrial Wastewater Facilities to Surface Water - Form 2CS*; or Part V.C. of *Application to Discharge Process Wastewater from New or Existing Industrial Wastewater Facilities to Ground Water - Form 2CG*.
- Priority pollutant scans performed in accordance with pretreatment program annual report requirements.
- Monitoring performed for the development or re-evaluation of local discharge limitations.
- Monitoring required in Table 4 of the Generic Permit for Discharges from Petroleum Contaminated Sites and Table 1 of the Generic Permit for the Discharge of Produced Ground Water from any Non-Contaminated Site Activity.

The low-level mercury method provides, for the first time, the ability to assess compliance with mercury water quality standards (WQSS) below 0.2 ug/L. Your permit requires that surface water discharges shall be analyzed using a sufficiently sensitive method in accordance with 40 CFR 136. *Wastewater Permit Application Forms 2A, 2CS, and 2CG* require effluent testing be conducted using methods that are able to detect pollutants at levels adequate to meet WQSS and to provide reasonable assurance that the WQSS will not be violated in the future.

Additionally, in order to develop technically and legally defensible local discharge limitations for domestic wastewater facilities that have pretreatment programs, Method 1631E must be used to provide data that clearly establishes the basis for any calculated mercury limitations. Note, regarding local discharge limitations, the requirement to use Method 1631E may be expanded to other locations in the collection and treatment system on a case-by-case basis depending on the initial results from effluent analysis using Method 1631E.

Mercury Laboratory Analysis

Method 1631E has a minimum level of quantitation of 0.0005 ug/L, or 0.5 nanograms per liter (ng/L), which is 400-times more sensitive than Method 245.1 ("Manual Cold Vapor Technique"). Due to the sensitivity of Method 1631E, the results are typically measured in parts per trillion (ng/L) rather than in parts per billion (µg/L). The Department is currently evaluating Method 1631E to determine target method detection limits (MDLs) and target practical quantification limits (PQLs). Until target MDLs and PQLs are incorporated into Rule 62-4.246(4), the laboratory analysis is expected to achieve MDLs close to, or below, 1 ng/L. All laboratory analysis must be done by a NELAP accredited laboratory with current certification by Florida Department of Health for Method 1631E.

Mercury Clean Sampling Techniques

Clean sample handling techniques should be used when collecting samples for low-level mercury analysis to preclude false positives arising from sample collection, handling, or analysis. Sample collection methods should be consistent with *DEP-SOP-001/01: FS 8200 Clean Sampling For Ultratrace Metals in Surface Waters* and *EPA Method 1669: Sampling Ambient Water for Trace Metals at EPA Water Quality Criteria Levels* (EPA-821-R-96-011). Because FS 8200 and Method 1669 are performance-based procedures, sample collection personnel may modify these procedures or eliminate steps if the modification does not lead to unacceptable contamination of samples or blanks. Any modifications should be thoroughly evaluated and demonstrated to be effective before field samples are collected. This may be accomplished through documentation of uncontaminated samples, equipment blanks and/or other quality control samples.

Note, discrete and composite samplers have been found to contaminate samples with mercury at the ng/L level. Therefore, grab samples are permissible when using Method 1631E. However, grab samples must be representative of the wastewater discharge and a field blank should be collected along with the sample.

In order for a permittee to justify a claim that any reported mercury is due to outside contamination, a blank must have been collected. For this reason, permittees should consider collecting at least one blank at each site for each day a sample is collected. If more than one sample is collected in a day, at least one blank for each 10 samples collected on that day should also be collected. The blank may either be an equipment blank or a field blank. Once a permittee demonstrates the ability to collect samples from a given site using an established procedure that prevents contamination, the permittee may choose to decrease the number of blanks being taken. Specific definitions and procedures for collecting blanks are found in DEP SOP FQ 1000.

Field blanks should be collected only if no equipment other than the sample container is used to collect samples. If the sampling procedure involves the use of additional equipment, such as a peristaltic pump and pump tubing, equipment blanks should be collected. All blanks are subject to the same preservation, digestion, and analysis protocols as regular samples and should have a concentration at least five times lower than the sample concentration. The permittee may not subtract field blank concentrations when reporting sample results.

Sample-collection, preservation, and shipping requirements should be discussed with contract laboratories to ensure the requirements of Method 1631E are met.

Additional Assistance and Information

For additional information on Method 1631:
www.epa.gov/waterscience/methods/1631.html

Please refer questions concerning sample collection to:
Silky Labic: 850-245-8066
Silky.Labic@dep.state.fl.us

Additional information concerning NELAP certified laboratories can be obtained from:
Department of Health Bureau of Laboratories
P.O. Box 210 Jacksonville, FL 32231
(904) 791-1599 (voice)(904) 791-1591 (fax)
[ftp.dep.state.fl.us/pub/labs/assessment/doh/accredited.pdf](ftp://ftp.dep.state.fl.us/pub/labs/assessment/doh/accredited.pdf)

**ORANGE COUNTY ENVIRONMENTAL PROTECTION DIVISION
WORK INSTRUCTION**

Related Documents:

Florida Department of Environmental Protection's Construction Generic Permit

History of Revisions:

Revision No.	Revision Date	Summary of Revisions
0	06/06/2011	Original
1	10/04/2011	Update contact information



UNITED STATES ENVIRONMENTAL PROTECTION AGENCY
WASHINGTON, D.C. 20460

OFFICE OF
WATER

signed: August 23, 2007

MEMORANDUM

SUBJECT: Analytical Methods for Mercury in National Pollutant Discharge Elimination System (NPDES) Permits

FROM: James A. Hanlon, Director
Office of Wastewater Management

TO: Water Division Directors, Regions 1 - 10

The purpose of this memorandum is to inform you of EPA's March 12, 2007, approval of Method 245.7 for measurement of mercury and modified versions of approved analytical methods for mercury as well as the impact of their approval on the NPDES permitting process. While several different methods are currently approved under 40 CFR Part 136 for the analysis of mercury, some of these methods have much greater sensitivities and lower quantitation levels than others. This memorandum clarifies and explains that, in light of existing regulatory requirements for NPDES permitting,¹ only the most sensitive methods such as Methods 1631E and 245.7 are appropriate in most instances for use in deciding whether to set a permit limitation for mercury and for sampling and analysis of mercury pursuant to the monitoring requirements within a permit.

BACKGROUND

Section 301 of the Clean Water Act (CWA) requires NPDES permits to include effluent limitations that are as stringent as necessary to meet water quality standards. Thus, under the Act and EPA regulations, each permit must include, as necessary, requirements in addition to or more stringent than technology-based effluent limitations established under section 301 of the CWA in order to achieve water quality standards. 40 C.F.R. § 122.44(d)(1). The regulations require limitations to control all pollutants that the NPDES program director determines are or may be discharged at a level that "will cause, have the reasonable potential to cause, or contribute to an excursion above any state water quality standard," including both narrative and

¹ This memorandum is based on existing legal requirements and authorities. It does not impose any new, legally binding requirements on EPA, states, or the regulated community.

numeric criteria, 40 C.F.R. § 122.44(d)(1)(i). If the program director determines that a discharge has the reasonable potential to cause or contribute to such an excursion, the permit must contain water quality-based effluent limitations for the pollutant, 40 C.F.R. § 122.44(d)(1)(iii). Thus, a prospective permittee may need to measure various pollutants in its effluent at two stages: first, at the permit application stage so that the program director can determine whether “reasonable potential” exists and establish appropriate permit limits; and second, where a permit limit has been established, to meet the monitoring requirements within the permit. The following discussion explains which analytical methods permit applicants and permittees should use to make these measurements when mercury is the pollutant at issue.

Approved Analytical Methods

Measurements included on NPDES permit applications and on reports required to be submitted under the permit must generally be made using analytical methods approved by EPA under 40 CFR Part 136. See 40 CFR 136.1, 136.4, 136.5, 122.21(g)(7), and 122.41(j). For mercury, there are three methods commonly used in the NPDES program that EPA has approved under Part 136: Method 245.1, Method 245.2, and Method 1631E. Methods 245.1 and 245.2 were approved by EPA in 1974 and can achieve measurement of mercury down to 200 parts per trillion (ppt). Additionally, EPA approved Method 1631 Revision E in 2002. Method 1631E has a quantitation level of 0.5 ppt, making it 400 times more sensitive than Methods 245.1 and 245.2. In fact, the sensitivity of Methods 245.1 and 245.2 are well above the water quality criteria now adopted in most states (as well as the criteria included by EPA in the Final Water Quality Guidance for the Great Lakes System) for the protection of aquatic life and human health, which generally fall in the range of 1 to 50 ppt.² In contrast, Method 1631E, with a quantitation level of 0.5 ppt, does support the measurement of mercury at these low levels.

In addition to Methods 245.1, 245.2, and 1631E listed above, EPA approved Method 245.7 as well as modified versions of other EPA-approved methods on March 12, 2007. See 72 FR 11200. Method 245.7 has a quantitation level of 5.0 ppt, making it 40 times more sensitive than Methods 245.1 and 245.2. Additionally, modified versions of EPA-approved methods may also be used for the measurement of mercury. Methods approved under Part 136, such as 245.1 and 245.2, may be modified to achieve lower quantitation levels than can be achieved by the method as written.³ Modifications to an EPA-approved method for mercury that meet the method

² Many states have adopted mercury water quality criteria of 12 ppt for protection of aquatic life and 50 ppt for the protection of human health, and for discharges to the Great Lakes Basin, the applicable water quality criteria for mercury are 1.3 ppt for the protection of wildlife and 1.8 ppt for the protection of human health. In 2001, EPA issued new recommended water quality criteria guidance for the protection of human health. This new guidance recommends adoption of a methylmercury water quality criterion of 0.3 milligrams of methylmercury per kilogram (mg/kg) in fish tissue. EPA is currently developing implementation guidance to assist states in implementing the criterion, and *Draft Guidance for Implementing the January 2001 Methylmercury Water Quality Criterion* (EPA-823-B-04-001) was released for public comment in August 2006.

³ Examples of such modification may include changes in the sample preparation digestion procedures such as the use of reagents similar in properties to ones used in the approved method, changes in the equipment operating parameters such as the use of an alternate more sensitive wavelength, adjusting the sample volume to optimize method performance, and changes in the calibration ranges (provided that the modified range covers any relevant regulatory limit).

performance requirements of Part 136.6 are considered to be approved methods and require no further EPA approval. See 72 FR 11239-40 (March 12, 2007). For analytical method modifications that do not fall within the flexibility of Part 136.6, the modified methods may be approved under the alternate test procedure program as defined by Parts 136.4 and 136.5.

ACTIONS RESULTING FROM THE MARCH 12, 2007, RULEMAKING

To implement the March 12, 2007, rule, the Office of Wastewater Management (OWM) provides the following guidance:

Monitoring Data Submitted as Part of NPDES Permit Applications

As noted, most states have adopted water quality criteria for the protection of aquatic life and human health that fall in the range of 1 to 50 ppt, and Methods 245.1 and 245.2, as written, do not detect or quantify mercury in this range. A "did not detect" result using Method 245.1 or Method 245.2 would show only that mercury levels are below 200 ppt but would not establish that they are at or below the applicable water quality criterion. Therefore, when a permit writer receives a permit application reporting mercury data analyzed with Method 245.1 or Method 245.2 as "did not detect" results, the permit writer in reality may lack the information needed to make a "reasonable potential" determination. In contrast, Method 1631E is able to detect and quantify mercury concentrations at these low levels.

EPA therefore expects, in general, that all facilities with the potential to discharge mercury will provide with their NPDES permit applications monitoring data for mercury using Method 1631E or another sufficiently sensitive EPA-approved method. For purposes of permit applications, a method for mercury is "sufficiently sensitive" when (1) its method quantitation level is at or below the level of the applicable water quality criterion for mercury or (2) its method quantitation level is above the applicable water quality criterion, but the amount of mercury in a facility's discharge is high enough that the method detects and quantifies the level of mercury in the discharge.⁴ Accordingly, EPA strongly recommends that the permitting authority determine that a permit application that lacks effluent data analyzed with a sufficiently sensitive EPA-approved method such as Method 1631E is incomplete unless and until the facility supplements the original application with data analyzed with such a method. See 40 CFR 122.21(e) (a permit application is determined to be complete at the discretion of the permitting authority) and 40 CFR 122.21(g)(13) (the applicant shall provide to the Director, upon request, such other information as the Director may reasonably require to assess the discharge). Such data would allow the permitting authority to characterize the effluent to determine whether the discharge causes, has the reasonable potential to cause, or contributes to an excursion of state water quality standards for mercury and would consequently allow the permitting authority to determine whether a water quality-based effluent limit for mercury is necessary in the permit.

⁴ To illustrate the latter, if the water quality criterion for mercury in a particular state is 2.0 ppt, Method 245.7 (with a quantitation level of 5.0 ppt) would be sufficiently sensitive where it reveals that the level of mercury in a facility's discharge is 5.0 ppt or greater. In contrast, Method 245.7 would not be sufficiently sensitive if it resulted in a level of non-detect for that discharge because it could not be known whether mercury existed in the discharge at a level between 2.0 and 5.0 (less than the quantitation level but exceeding the water quality criterion).

Monitoring Requirements in Permits

Where a permit authority establishes a permit limit for mercury, it also needs to consider specifying an analytical method that the permittee must use to monitor for mercury during the term of the permit. Methods 245.1 and 245.2, as written, are not likely to be sensitive enough to detect or quantify the concentration of mercury in the discharge at a level that matches the limitation for mercury in the permit. EPA therefore expects the permitting authority to require the use of a sufficiently sensitive EPA-approved method for monitoring under the permit in order to ensure that the sampling and measurements required are "representative of the monitored activity" (as required by 40 CFR 122.41(j)(1)). For purposes of monitoring under a permit, a method for mercury is "sufficiently sensitive" when (1) its method quantitation level is at or below the level of the mercury limit established in the permit or (2) its method quantitation level is above the mercury limit in the permit, but the amount of mercury in a facility's discharge is high enough that the method detects and quantifies the level of mercury in the discharge.⁵

EPA Permit Review and Objection to State Issued Permits

For NPDES-authorized states, EPA regions are expected to review state permits and should strongly consider objecting to permits that are issued based on analytical data collected and analyzed using an EPA-approved method that is not sufficiently sensitive or that do not require use of a sufficiently sensitive EPA-approved method for monitoring when the permit includes a limit for mercury. OWM is expecting to undertake a permit quality review of a small representative number of permits with respect to mercury limitations and other conditions.

If you have questions concerning the content of this memorandum, please contact Linda Boornazian, Director of the Water Permits Division, at 202-564-0221 or have your staff contact Marcus Zobrist of the State and Regional Branch at 202-564-8311 or zobrist.marcus@epa.gov.

cc: NPDES Branch Chiefs Regions 1 - 10

⁵ See footnote 4.

**SECTION 01001
GENERAL WORK REQUIREMENTS**

TABLE OF CONTENTS

PART 1 - GENERAL	3
1.01 NOTICE AND SERVICE	3
1.02 WORK TO BE DONE	3
1.03 DRAWINGS AND PROJECT MANUAL.....	3
1.04 PROTECTION AND RESTORATION.....	5
1.05 PUBLIC NUISANCE.....	6
1.06 CONTRACTOR’S PAYMENTS TO COUNTY FOR OVERTIME WORK	6
1.07 MAINTENANCE OF SERVICE	7
1.08 TRANSFER OF SERVICE.....	7
1.09 LABOR.....	7
1.10 MATERIALS AND EQUIPMENT.....	8
1.11 MANUFACTURER'S SERVICE	9
1.12 INSPECTION AND TESTING.....	9
1.13 PROJECT SITE AND ACCESS	12
1.14 UTILITIES	12
1.15 RELATED CONSTRUCTION REQUIREMENTS	16
1.16 CONSTRUCTION NOT PERMITTED.....	21
PART 2 - PRODUCTS (NOT USED)	222221
PART 3 - EXECUTION (NOT USED).....	222221

SECTION 01001
GENERAL WORK REQUIREMENTS
TABLE OF CONTENTS

[THIS PAGE INTENTIONALLY LEFT BLANK](#)

← - - - Formatted: Centered

SECTION 01001
GENERAL WORK REQUIREMENTS

PART 1 - GENERAL

1.01 NOTICE AND SERVICE

- A. In conformance with the requirements of Notice and Service of the General Conditions, all notices or other papers required to be delivered by the Contractor to the County shall be delivered to the office of the Engineering Division, Orange County Utilities Department, 9150 Curry Ford Road, Orlando, FL 32825.

1.02 WORK TO BE DONE

- A. The Contractor shall furnish all labor, materials, equipment, tools services and incidentals to complete all work required by these specifications and as shown on the Drawings, at a rate of progress which will ensure completion of the Work within the Contract Time stipulated.
- B. All materials, equipment, skills, tools and labor which is reasonably and properly inferable and necessary for the proper completion of the Work in a substantial manner and in compliance with the requirements stated or implied by these Specifications or Drawings shall be furnished and installed by the Contractor without additional compensation, whether specifically indicated in the Contract Documents or not.
- C. The Contractor shall perform the Work complete, in place, and ready for continuous service, and shall include repairs, testing, permits, clean up, replacements, and restoration required as a result of damages caused during this construction.
- D. The Contractor shall comply with all City, County, State, Federal, and other codes, which are applicable to the proposed construction Work.
- E. All newly constructed Work shall be carefully protected from injury in any way. No wheeling, walking, or placing of heavy loads on it shall be allowed and all portions damaged shall be reconstructed by the Contractor at his own expense.
- F. Scope of Work: See Section 01010 "Summary of Work" and the Bid Schedule for details.

1.03 DRAWINGS AND PROJECT MANUAL

- A. The Work shall be performed in accordance with the Drawings and Specifications prepared by the County/Professional. All work and materials shall conform to the Orange County Utilities Standards and Construction Specifications Manual, latest edition or as indicated in these Specifications or Drawings.

- B. The Contractor shall verify all dimensions, quantities and details shown on the Drawings, Supplementary Drawings, Schedules, Specifications or other data received from the County/Professional, and shall notify same, in writing, of all errors, omissions, conflicts and discrepancies found therein. Failure to discover or correct errors, conflicts or discrepancies shall not relieve the Contractor of full responsibility for unsatisfactory Work, faulty construction or improper operation resulting there from, nor from rectifying such conditions at his own expense.
- C. All schedules are given for the convenience of the County and the Contractor and are not guaranteed to be complete. The Contractor shall assume all responsibility for the making of estimates of the size, kind, and quantity of materials and equipment included in the Work to be done under this Contract.
- D. Intent:
1. **All Work called for in the Specifications applicable to this Contract, but not shown on the Drawings in their present form, or vice versa, shall be of like effect as if shown or mentioned in both. Work not specified either in the Drawings or in the Specifications, but involved in carrying out their intent or in the complete and proper execution of the Work, is required and shall be performed by the Contractor as though it were specifically delineated or described.**
 2. **Items of material, equipment, machinery, and the like may be specified on the Drawings and not in the Specifications. Such items shall be provided by the Contractor in accordance with the specification on the Drawings.**
 3. **The apparent silence of the Specifications as to any detail, or the apparent omission from them of a detailed description concerning any Work to be done and materials to be furnished, shall be regarded as meaning that only the best general practice is to prevail and that only material and workmanship of the best quality is to be used, and interpretation of these Specifications shall be made upon that basis.**
- E. When obtaining data and information from the Drawings, conflicts, errors, and discrepancies shall be resolved from the documents given the following order of precedence:
1. **Agreement**
 2. **Change Orders**
 3. **Addenda**
 4. **Supplementary Conditions**
 5. **Instructions to Bidders**
 6. **General Conditions**
 7. **Specifications (Divisions. 1 through 16)**
 8. **Drawings**
 9. **Dimensions**
When measurements are affected by conditions already established or where items are to be fitted into constructed conditions, it shall be the Contractor's responsibility to verify all such dimensions at the site and the actual job dimensions shall take precedence over scale and figure dimensions on the Drawings.
 10. **Full-size Drawing**

11. **Large-scale Drawing**
12. **Small-scale Drawing**
13. **Advertisement for Bids**
14. **Bid**
15. **Bonds**
16. **Insurance Certificates**
17. **Insurance Endorsements**
18. **Affidavits**

1.04 PROTECTION AND RESTORATION

- A. The Contractor shall be responsible for the preservation of all public and private property, and shall use every means of protection necessary to prevent damage thereto. If any direct or indirect damage is done to public or private property by or on account of any act, omission, neglect, or misconduct in the execution of the Work on the part of the Contractor, such property shall be restored by the Contractor, at his expense, to a condition similar or equal to that existing before the damage was done, or he shall make good the damage in other manner acceptable to the County/Professional.
- B. Protection of Trees and Shrubs
 1. **Protect with boxes or other barricades.**
 2. **Do not place excavated material so as to injure trees or shrubs.**
 3. **Install pipelines in short tunnels between and under root systems.**
 4. **Support trees to prevent root disturbance during nearby excavation.**
- C. Tree and Limb Removal
 1. **Tree limbs, which interfere with equipment operation and are approved for pruning, shall be neatly trimmed and the tree cut coated with tree paint.**
 2. **The County may order the Contractor, for the convenience of the County, to remove trees along the line or trench excavation. The Contractor shall obtain any permits required for removal of trees. Ordered tree removal shall be paid for under the appropriate Contract Items.**
- D. Trees or shrubs destroyed by negligence of the Contractor or his employees shall be replaced by him with new stock of similar size and age, at the proper season and at the sole expense of the Contractor.
- E. Lawn Areas: All lawn areas disturbed by construction shall be replaced with like kind to a condition similar or equal to that existing before construction. Where sod is to be removed, it shall be carefully removed, and the same re-sodded, or the area where sod has been removed shall be restored with new sod in the manner described in the applicable section.
- F. Fences: Any fence, or part thereof, that is damaged or removed during the course of the Work shall be replaced or repaired by the Contractor, and shall be left in as good a condition as before the starting of the Work.

- G. Where fencing, walls, shrubbery, grass strips or area must be removed or destroyed incident to the construction operation, the Contractor shall, after completion of the Work, replace or restore to the original condition all such destroyed or damaged landscaping and improvements.
- H. The cost of all labor, materials, equipment, and work for restoration shall be deemed included in the appropriate Contract Item or items, or if no specific item is provided therefore, as part of the overhead cost of the Work, and no additional payment will be made therefore.

1.05 PUBLIC NUISANCE

- A. The Contractor shall not create a public nuisance including, but not limited to, encroachment on adjacent lands, flooding of adjacent lands, or excessive noise.
- B. Sound levels measured by the County/Professional shall not exceed 45 dBA from 8 p.m. to 8 a.m. or 55 dBA 8 a.m. to 8 p.m. This sound level shall be measured at the exterior of the nearest exterior wall of the nearest residence. Levels at the equipment shall not exceed 85 dBA at any time. Sound levels in excess of these values are sufficient cause to have the Work halted until equipment can be quieted to these levels. Work stoppage by the County/Professional for excessive noise shall not relieve the Contractor of the other portions of this specification including, but not limited to, completion dates and bid amounts.
- C. No extra charge may be made for time lost due to work stoppage resulting from the creation of a public nuisance.

1.06 CONTRACTOR'S PAYMENTS TO COUNTY FOR OVERTIME WORK

- A. County Inspector Work Hours: Normal work hours for the County's inspector(s) are defined as any 8-hour period between the hours of 7:00 a.m. and 7:00 p.m. on the weekdays of Monday through Friday. Any County Inspector(s) work beyond the aforementioned normal work hours shall be requested in writing 48-hours in advance. All overtime and weekend work compensation to the County's Inspector(s) for working beyond the normal working hours are considered overtime compensation and shall be paid for by the Contractor at the overtime pay rate of \$47.50 per hour. This overtime pay rate is subject to adjustment by the County. The Contractor agrees that the County shall deduct charges for work outside normal work hours and for overtime pay from payments due the Contractor.

1.07 MAINTENANCE OF SERVICE

- A. If this project includes the demolition, rehabilitation and replacement of facilities that transmit wastewater within a wastewater collection system; the collection and transmission of wastewater is a continuous operation and must remain in service at all times. Unless noted otherwise on the plans, the operation of the existing wastewater pumping facility on each of the respective locations shall remain in service until the transfer of service has been completed. See "Transfer of Service" for additional description of these requirements. In lieu of maintaining the existing pumping station, the Contractor may provide bypass pumping. Bypass pumping provided by the Contractor either as alternate to maintaining the existing pumping facility or as required when noted on the specific facility plan shall meet the requirements as noted in Section 01516 "Collection System Bypass."
- B. The Contractor shall, prior to interrupting any utility service (water, sewer, etc.) for the purpose of making cut-ins to the existing lines or for any other purposes, contact the County and make arrangements for the interruption which will be satisfactory to the County.
- C. Utility lines that are damaged during construction shall be repaired by the Contractor and service restored within 4-hours of the breakage. The County retains the option of repairing any damage to utility pipes in order to expedite service to the customers. The Contractor will remain responsible for all costs associated with the repair.

1.08 TRANSFER OF SERVICE

- A. The Contractor shall use temporary plugs in the existing and proposed sewer lines to control the routing of gravity flow to the active pumping facility during the transfer period. The proposed pumping facility shall be constructed while the existing or bypass facility is in operation. When the County has accepted the proposed facilities and placed the facility into operation, the transfer of service is complete. The Contractor may begin the work of removing the existing facility or bypass pumping equipment. The Contractor shall also install permanent plugs in the sewer pipes to allow abandonment or removal of the existing sewer system and pumping facilities as noted on the plans.

1.09 LABOR

- A. Supervision: The Contractor shall keep the Contract under his own control and it shall be his responsibility to see that the Work is properly supervised and carried on faithfully and efficiently. The Contractor shall supervise the Work personally or shall have a competent, English speaking superintendent or representative, who shall be on the site of the Project at all working hours, and who shall have full authority by the Contractor to direct the performance of the Work and make arrangements for all necessary materials, equipment, and labor without delay.

- B. Jurisdictional Disputes: It shall be the responsibility of the Contractor to pay all costs that may be required to perform any of the Work shown on the Drawings or specified herein to avoid any work stoppages due to jurisdictional disputes. The basis for subletting work in question, if any, shall conform to precedent agreements and decisions on record with the Building and Construction Trades Department, AFL-CIO, dated June, 1973, including any amendments thereto.
- C. Apprenticeship: The Contractor shall comply with all of the requirements of Section 446, Florida Statutes, for all contracts in excess of \$25,000 excluding roadway, highway or bridge contracts and the Contractor agrees to insert in any subcontract under this Contract the requirements of this Article.

1.10 MATERIALS AND EQUIPMENT

A. MANUFACTURER

1. **All transactions with the manufacturers or Subcontractors shall be through the Contractor, unless the Contractor shall request and at the County/Professional's option, that the manufacturer or Subcontractor communicate directly with the County/Professional. Any such transactions shall not in any way release the Contractor from his full responsibility under this Contract.**
2. **All workmanship and materials shall be of the highest quality. The equipment shall be the product of manufacturers who are experienced and skilled in the field with an established record of research and development. No equipment will be considered unless the manufacturer has designed and manufactured equipment of comparable type and size and have demonstrated sufficient experience in such design and manufacture.**
3. **All materials and equipment furnished by the Contractor shall be subject to the inspection, review and acceptance of the County and meet the requirements as outlined in the Orange County Utilities Standards and Construction Specifications Manual. No material shall be delivered to the Work without prior approval of the County/Professional.**
4. **All apparatus, mechanisms, equipment, machinery, and manufactured articles for incorporation into the Project shall be the new (most current production at time of bid) and unused standard products of recognized reputable manufacturers.**
5. **Manufactured and fabricated products:**
 - a. Design, fabricate and assemble in accord with the best engineering and shop practices.
 - b. Manufacture like parts of duplicate units to standard sizes and gauges, to be interchangeable.
 - c. Any two or more pieces of material or equipment of the same kind, type or classification, and being used for identical types of service, shall be made by the same manufacturer.
 - d. Products shall be suitable for service conditions as specified and as stated by manufacturer.
 - e. Equipment capacities, sizes and dimensions shown or specified shall be adhered to unless variations are specifically approved in writing.

- f. Do not use material or equipment for any purpose other than that for which it is designed or is specified.

1.11 MANUFACTURER'S SERVICE

- A. Where service by the manufacturer is specified to be furnished as part of the cost of the item of equipment, the Work shall be at the Contractor's expense.
- B. The services provided shall be by a qualified manufacturer's service representative to check and verify the completed installation, place the equipment in operation, and instruct the County's operators in the operation and maintenance procedures. Such services are to be for period of time and for the number of trips specified. A working day is defined as a normal 8-hour working day on the job and does not include travel time.
- C. The services shall further demonstrate to the County/Professional's complete satisfaction that the equipment will satisfactorily perform the functions for which it has been installed.

1.12 INSPECTION AND TESTING

- A. General
 - 1. **If, in the testing of any material or equipment, it is ascertained by the County/Professional that the material or equipment does not comply with the Contract, the Contractor shall be notified thereof, and he will be directed to refrain from delivering said material or equipment, or to remove it promptly from the site or from the Work and replace it with acceptable material, without cost to the County.**
 - 2. **Tests of electrical and mechanical equipment and appliances shall be conducted in accordance with recognized test codes of the ANSI, ASME, or the IEE, except as may otherwise be stated herein.**
- B. Cost
 - 1. **County shall employ and pay for the services of an independent testing laboratory to perform testing specifically indicated on the Contract Documents or specified in the Specifications and may at any other time elect to have materials and equipment tested for conformity with the Contract Documents.**
 - 2. **The cost of field leakage and pressure tests and shop tests of materials and equipment specifically called for in the Contract Documents shall be borne by the Contractor, and such costs shall be deemed to be included in the Contract price.**
 - 3. **Notify County employed laboratory a minimum of 48-hours, sufficiently in advance of operations to allow for laboratory assignment of personnel and scheduling of tests. When tests or inspections cannot be performed after such notice, reimburse County for laboratory personnel and travel expenses incurred.**
 - 4. **The Contractor shall pay for all work required to uncover, remove, replace, retest, etc., any work not tested due to the Contractor's failure to provide the 48-hours advance notice or due to failed tests. The Contractor shall also provide**

compensation for the County/Professional's personnel for required re-testing due to failed or rescheduled testing.

C. Shop Testing

- 1. Each piece of equipment for which pressure, duty, capacity, rating, efficiency, performance, function or special requirements are specified shall be tested in the shop of the manufacturer in a manner which shall conclusively prove that its characteristics comply fully with the requirements of the Contract Documents. No such equipment shall be shipped to the worksite until the County/Professional notifies the Contractor, in writing, that the results of such tests are acceptable.**
- 2. Five (5) copies of the manufacturer's actual shop test data and interpreted results thereof, accompanied by a certificate of authenticity notarized and signed by a responsible official of the manufacturing company, shall be furnished to the County/Professional as a prerequisite for the acceptance of any equipment. The cost of shop tests (excluding cost of County's representative) and of furnishing manufacturer's preliminary and shop test data of operating equipment shall be borne by the Contractor and shall be included in the Contract price.**
- 3. The Contractor shall give notice in writing to the County sufficiently in advance of his intention to commence the manufacture or preparation of materials especially manufactured or prepared for use in or as part of the permanent construction. Such notice shall contain a request for inspection, the date of commencement and the expected date of completion of the manufacture or preparation of materials. Upon receipt of such notice, the County shall arrange to have a representative present at such times during the manufacture as may be necessary to inspect the materials; or he will notify the Contractor that the inspection will be made at a point other than the point of manufacture; or he will notify the Contractor that inspection will be waived.**
- 4. When inspection is waived or when the County/Professional so requires, the Contractor shall furnish to him authoritative evidence in the form of Certificates of Manufacture that the materials to be used in the Work have been manufactured and tested in conformity with the Contract Documents. These certificates shall be notarized and shall include five (5) copies of the results of physical tests and chemical analysis, where necessary, that have been made directly on the product or on similar products of the manufacturer.**
- 5. The Contractor must comply with these provisions before shipping any material. Such inspections by the County shall not release the Contractor from the responsibility for furnishing materials meeting the requirements of the Contract Documents.**

D. Field Testing:

- 1. The County shall employ and pay for services of an independent testing laboratory to perform testing specifically indicated in the Contract Documents. Employment of the laboratory shall in no way relieve Contractor's obligations to perform the Work of the Contract. The Contractor shall provide compensation for retesting of all failed tests.**
- 2. The County may at any time during the progress of the Work, request**

additional testing beyond that which is specified in the Contract. This testing will be at the County's expense. The Contractor shall assist the testing laboratory personnel in all ways so as to facilitate access to the location of the material or equipment to be tested. Contractor shall:

- a. Cooperate with laboratory personnel, provide access to the Project.
 - b. Secure and deliver to the laboratory adequate quantities of representative samples of materials proposed to be used and which require testing.
 - c. Provide to the laboratory the preliminary design mix proposed to be used for concrete, and other material mixes, which require control by the testing laboratory.
- 3. The following schedule summarizes the responsibilities of various tests that may be required by the Contract Documents. Contractor shall notify the County in advance of work so that arrangements can be made with the testing laboratory.**

TEST	NOTES	PAID FOR
Soil Compaction	A. Pipe Work: Every 300 ft. at each lift of compaction B. Structures: As a minimum one test per 2000 SF of fill area per lift, or at least 2 tests per structure, per lift. As specified in material specifications sections	County
Low Pressure Air Exfiltration	Each section of gravity sewer pipe between manholes or lift station	Contractor
Hydrostatic Pressure	All segments of pressure piping (24-hour test).	Contractor
Hydrostatic Leakage	All segments of pressure piping (2-hour test).	Contractor
Bacteriological	As required by local and state agencies	County
Asphaltic Concrete Paving	As required by County	County
LBR	Each 600 SY of pavement	County
Concrete	Slump test each delivery, cylinders every 20 CY	County
Asbestos	Environmental testing of materials	County
All Other Testing	As specified in various sections of the Project Manual	As Indicated

- E. Demonstration Tests: Upon completion of the Work and prior to final payment, all equipment and piping installed under this Contract shall be subjected to acceptance or demonstration tests as specified or required to provide compliance with the Contract Documents. The Contractor shall furnish all labor, fuel, energy, water and all other equipment necessary for the demonstration tests at no additional cost to the County.
- F. Final Inspection: Prior to preparation of the final payment application, a final inspection will be performed by the County to determine if the Work is properly and satisfactorily constructed in accordance with the requirements of the Contract Documents. See also Section 01700 "Project Closeout."
- G. Inspection by existing utility owners: The Contractor shall pay for all inspections during the progress of the Work required and provided by the owner of all existing public utilities paralleling or crossing the Work, as shown on the Drawings. All such inspection fees shall be deemed included in the appropriate Contract Item or items, or if no specific item is provided therefore, as part of the overhead cost of the Work, and no additional payment will be made therefore.

H. Inspection by Other Agencies: The Florida Department of Transportation, the Florida Department of Environmental Protection, and other authorized governmental agencies shall have free access to the site for inspecting materials and work, and the Contractor shall afford them all necessary facilities and assistance for doing so. Any instructions to the Contractor resulting from these inspections shall be given through the County. These rights of inspections shall not be construed to create any contractual relationship between the Contractor and these agencies.

1.13 PROJECT SITE AND ACCESS

A. RIGHT-OF-WAY AND EASEMENTS

1. **The use of public streets and alleys shall be such as to provide a minimum of inconvenience to the public and to other traffic. Any earth or other excavated material spilled from trucks shall be removed by the Contractor and the streets cleaned to the satisfaction of the County.**
2. **The Contractor shall not enter or occupy private land outside of easements, except by written permission of the property owner.**
3. **At the time of the Pre-Construction meetings, the Contractor shall fully acquaint himself with the status of all easements required for the Work and the possibility of parcels remaining to be acquired, if any. Should easements not be acquired by the County in specific areas of the Work, the Contractor shall sequence and reschedule his work therein so as not to interfere with the progress of work in other areas of the Project. Such rescheduling of work shall be performed by the Contractor at no additional cost to the County. The County agrees that it will make every effort to acquire all remaining easements with all speed and diligence possible so as to allow the completion of the Work within the Contract time.**

B. ACCESS

1. **Neither the material excavated nor the materials or equipment used in the construction of the Work shall be so placed as to prevent free access to all fire hydrants, valves or manholes.**
2. **Access to businesses located adjacent to the project site must be maintained at all times. Contractor may prearrange the closing of business access with the business Owner. Such prearranged access closing shall not exceed two (2) hours. Property drainage and grading shall be restored and all construction debris removed within 48-hours of backfilling trench.**
3. **Contractor agrees that representatives of the County and any governmental agents will have access to the Work wherever it is in preparation or progress and that the Contractor shall provide facilities for such access and inspection.**

1.14 UTILITIES

A. UTILITY CONSTRUCTION

1. **Public utility installations and structures shall be understood to include all poles, tracks, pipes, wires, conduits, house service connections, vaults, manholes and all other appurtenances and facilities pertaining thereto, whether owned or**

controlled by governmental bodies or privately owned by individuals, firms or corporations, used to serve the public with transportation, traffic control, gas, electricity, telephone, sewerage, drainage or water. Other public or private property, which may be affected by the Work, shall be deemed included hereunder.

2. **All open excavations shall be adequately safeguarded by providing temporary barricades, caution signs, lights and other means to prevent accidents to persons, and damage to property. The Contractor shall, at his own expense, provide suitable and safe bridges and other crossings for accommodating travel by pedestrians and workmen. Bridges provided for access to private property during construction shall be removed when no longer required.**
3. **The length of open trench will be controlled by the particular surrounding conditions, but shall always be confined to the limits described by the County. If any excavation becomes a hazard, or if it excessively restricts traffic at any point, the County may require special construction procedures. As a minimum, the Contractor shall conform to the following restoration procedures:**
 - a. **Interim Restoration:** All excavations shall be backfilled and compacted as specified by the end of each working day. For excavations within existing paved areas; limerock base or soil cement base (match existing) shall be spread and compacted to provide a relatively smooth surface free of loose aggregate material. At the end of each workweek, the S-I asphaltic surface course shall be completed and opened to traffic. Contractor shall coordinate his construction activity including density tests and inspections to allow sufficient time to achieve this requirement. All driveway cuts shall be backfilled, compacted, and limerock base spread and compacted immediately after installation. Contractor shall coordinate with the individual property owners prior to removing the driveway section. Any utility crossing an existing roadway, parking lot or other paved area shall be patched by the end of the working day.
 - b. All pipe and fittings shall be neatly stored in a location, which will cause the least disturbance to the public. All debris shall be removed and properly disposed of by the end of each working day.
 - c. **Final Restoration Overlay:** After completing all installations, and after testing of the pipe (but no sooner than 30-days after applying the S-I asphaltic surface), final restoration shall be performed. In no event shall final restoration begin after substantial completion. Final restoration shall provide an S-III asphaltic overlay as specified in an uninterrupted continuous operation until completion. Any additional restoration required after testing shall be repaired in a timely manner at no additional cost to the County.
 - d. Maintenance of all restored facilities shall be the Contractor's responsibility. This maintenance shall be performed on an on-going basis during the course of construction. The Contractor's Progress Schedule shall reflect the above restoration requirements.
 - e. **Additional Restoration for Work in Business or Commercial Districts:** The Contractor shall restore all private property, damaged by construction, to its original condition. Access to businesses located adjacent to the project site must be maintained at all times. Contractor may prearrange the closing of business accesses with the business owner. Such prearranged access closing shall not

exceed two (2) hours. Property drainage and grading shall be restored within 24-hours of backfilling trench.

B. EXISTING UTILITIES

1. **The locations of all existing underground piping, structures and utilities have been taken from information received from the respective owner. The locations are shown without express or implied representation, assurance, or guarantee that they are complete or correct or that they represent a true picture of underground piping, conduit and cables to be encountered. It is the Contractor's responsibility to verify all depths of marked locates as well as underground structures.**
2. **The Contractor shall, at all times in performance of the Work, employ acceptable methods and exercise reasonable care and skill so as to avoid unnecessary delay, injury, damage or destruction of existing public utility installations and structures; and shall, at all times in the performance of the Work, avoid unnecessary interference with, or interruption of, public utility services; and shall cooperate fully with the owners thereof to that end.**
3. **Pipelines shall be located substantially as indicated on the Drawings, but the County reserves the right to make such modifications in locations as may be found desirable to avoid interference with existing structures or for other reasons. When the location of piping is dimensioned on the Drawings, it shall be installed in that location; when the location of piping is shown on a scaled drawing, without dimensions, the piping shall be installed in the scaled location unless the County approves an alternate location for the piping. Where fittings are noted on the Drawings, such notation is for the Contractor's convenience and does not relieve him from laying and jointing different or additional items where required. The County/Professional may require detailed pipe laying drawings and schedules for project control.**
4. **The Contractor shall exercise care in any excavation to locate all existing piping and utilities. All utilities, which do not interfere with the completed work, shall be carefully protected against damage. Any existing utilities damaged in any way by the Contractor shall be restored or replaced by the Contractor at his expense as directed by the County. Any existing facilities, which require operation to facilitate repairs, shall be operated only by the owner of the respective utility.**
5. **It is the responsibility of the Contractor to ensure that all utility or other poles, the stability of which may be endangered by the proximity of excavation, be temporarily stayed and/or shored in position while work proceeds in the vicinity of the pole and that the utility or other companies concerned be given reasonable advance notice of any such excavation by the Contractor.**

C. NOTICES

1. **All governmental utility departments and other owners of public utilities, which may be affected by the Work, will be informed in writing by the Contractor two (2) weeks after the execution of the Contract or Contracts covering the Work. Such notice will be sent out in general, and directed to the attention of the governmental utility departments and other owners of public utilities for such installations and structures as may be affected by the Work.**

2. **The Contractor shall also comply with Florida Statute 553.851 regarding notification of existing gas and oil pipeline company owners. Evidence of such notice shall be furnished to the County within two (2) weeks after the execution of the Contract.**
3. **It shall be the Contractor's responsibility to contact utility companies at least 72-hours in advance of breaking ground in any area or on any unit of the Work so maintenance personnel can locate and protect facilities, if required by the utility company.**
4. **The Contractor shall give a minimum five (5) working day notice prior to utility personnel interrupting a utility service (water, sewer, etc.) for the purpose of making cut-ins to the existing lines or for any other purposes, contact the utility owner and make arrangements for the utility personnel to isolate the existing lines thus providing interruption which will be satisfactory to the utility owner.**

D. EXPLORATORY EXCAVATIONS

1. **Exploratory excavations shall be conducted by the Contractor for the purpose of locating underground pipelines or structures in advance of the construction. Test pits shall be excavated in areas of potential conflicts between existing and proposed facilities and at piping connections to existing facilities a minimum of 48-hours or 1,000-feet in advance of work. If there is a potential conflict, the Contractor is to notify the County/Professional immediately. Information on the obstruction to be furnished by the Contractor shall include: Location, Elevation, Utility Type, Material and Size. Test pits shall be backfilled immediately after their purpose has been satisfied and the surface restored and maintained in a manner satisfactory to the County.**

E. UTILITY CROSSINGS

1. **It is intended that wherever existing utilities must be crossed, deflection of the pipe within specified limits and cover shall be used to satisfactorily clear the obstruction unless otherwise indicated on the Drawings. However, when in the opinion of the County this procedure is not feasible, he may direct the use of fittings for a utility crossing or conflict transition as detailed on the Drawings.**

F. RELOCATIONS

1. **Relocations shown on the Drawings: Public utility installations or structures, including but not limited to light poles, signs, fences, piping, conduits and drains that interfere with the positioning of the Work which are shown on the Drawings to be removed, relocated, replaced or rebuilt by the Contractor shall be considered as part of the general cost of doing the Work and shall be included in the prices bid for the various contract items. No separate payment shall be made therefore.**
2. **Relocations not shown on the Drawings**
 - a. **Where public utility installations or structures are encountered during the course of the Work, and are not indicated on the Drawings or in the Specifications, and when, in the opinion of the County, removal, relocation, replacement or rebuilding is necessary to complete the Work under this contract, such work shall**

be accomplished by the utility having jurisdiction, or such work may be ordered, in writing by the County, for the Contractor to accomplish.

- b. If such work is accomplished by the utility having jurisdiction, it will be carried out expeditiously and the Contractor shall give full cooperation to permit the utility to complete the removal, relocation, replacement or rebuilding as required. If such work is accomplished by the Contractor, it will be paid for as a Change Order.
3. **All existing castings, including valve boxes, junction boxes, manholes, hand holes, pull boxes, inlets and similar structures in the areas of construction that are to remain in service and in areas of trench restoration and pavement replacement, shall be adjusted by the Contractor to bring them flush with the surface of the finished work.**
4. **All existing utility systems which conflict with the construction of the Work herein, which can be temporarily removed and replaced, shall be accomplished at the expense of the Contractor. Work shall be done by the utility unless the utility approves in writing that the Work may be done by the Contractor.**

1.15 RELATED CONSTRUCTION REQUIREMENTS

A. PUBLIC INFORMATION OFFICER

1. The Contractor shall provide community interaction and coordination through a designated Public Information Officer (PIO). The PIO will provide complaint and problem resolutions for community members affected by the construction for the entire project duration. The PIO will manage a 24 hour hotline phone number for citizens to call regarding questions or problems they may experience with respect to the construction activities. The PIO will field these calls, provide answers to questions, research issues with the project team or appropriate agencies and follow up each complaint in a timely manner. The PIO will maintain a daily diary of call and/or interactions with the community, as well as a complaint log chronicling all issues and proposed resolutions.
2. The PIO will attend the monthly project progress meetings and provide the project team with a report of public issues for the previous month. The PIO will also disseminate roadway closures, sewer hookups, temporary and permanent restoration and other relevant construction information to the community, as well as, when appropriate, to the media, emergency services personnel and other interested agencies.
3. The designated PIO shall have previous experience in providing similar services on Orange County Utilities, Orange County Public Works or FDOT construction projects. The PIO shall be bi-lingual (English and Hispanic) and physically capable of visitation to the construction site, meeting locations and affected resident's homes without special assistance.

B. TRAFFIC MAINTENANCE

1. **Maintain public highway traffic within the limits of the Project for the duration of the construction period, including any temporary suspensions of Work. Work shall also include construction and maintenance of any necessary detour facilities; furnishing, installing and maintaining of traffic control and safety**

- devices during construction, control of dust, or any other special requirements for safe and expeditious movement of vehicular and pedestrian traffic.
2. **Traffic Control shall be provided at the Contractor's expense by the Contractor's personnel or off-duty uniformed police officer, depending on and as required by the applicable traffic control requirements jurisdictional to the construction or road.**
 3. **The Contractor shall prepare and submit a Maintenance of Traffic plan (MOT) to the County/Professional and to the County Public Works Department for review and acceptance prior to commencing any Work on the site. The Traffic Control Plan shall detail procedures and protective measures proposed by the Contractor to provide for protection and control of traffic affected by the Work consistent with the following applicable standards:**
 - a. Standard Specifications for Road and Bridge Construction, Latest Edition including all subsequent supplements issued by the Florida Department of Transportation, (FDOT Spec.).
 - b. Manual of Traffic Control and Safe Practices for Street and Highway Construction, Maintenance and Utility Operations, FDOT.
 - c. Right-of-Way Utilization Regulations, Orange County, Florida, latest edition. All references to the respective agency in the above referenced standards shall be construed to also include the County for this Work.
 - d. The cost of any required road permits shall be borne by the Contractor.
 - e. The Contractor will notify the public one (1) week in advance of any scheduled work via the use of portable message boards. The message boards shall be located at each approach to the construction area.
 4. **Before closing any thoroughfare, the Contractor shall give written notice to, and if necessary, obtain a permit or permits from the duly constituted public authority having jurisdiction over the thoroughfare. Notice shall be given no less than 72-hours in advance of the time when it may be necessary in the process of construction to close such thoroughfare, or as may be otherwise provided in the acceptable Maintenance of Traffic plan (MOT).**
 5. **The Contractor shall sequence and plan construction operations and shall generally conduct his work in such a manner as not to unduly or unnecessarily restrict or impede existing normal traffic through the streets of the local community.**
 6. **Insofar as it is practicable, excavated material and spoil banks shall not be located in such a manner as to obstruct traffic. The traveled way of all streets, roads and alleys shall be kept clear and unobstructed insofar as is possible and shall not be used for the storage of construction materials, equipment, supplies, or excavated earth, except when and where necessary.**
 7. **If required by duly constituted public authority, the Contractor shall, at his own expense, construct bridges or other temporary crossing structures over trenches so as not to unduly restrict traffic. Such structures shall be of adequate strength and proper construction and shall be maintained by the Contractor in such a manner as not to constitute an undue traffic hazard. Private driveways shall not be closed except when and where necessary, and then only upon due advance notice to the County and for the shortest practicable period of time consistent with efficient and expeditious construction. The Contractor shall be liable for**

- any damages to persons or property resulting from his work.
8. **The Contractor shall make provisions at all "open cut" street crossings to allow a minimum of one lane to be open for vehicular traffic at all times. Lane closing shall be as permitted by the local governing authority and shall be repaired to a smooth, safe driving surface immediately following the installation of pipe or conduit. Flagmen shall be required, in addition to barricades, signs and other protective devices at all lane closings.**
 9. **The Contractor shall make provisions at cross streets for the free passage of vehicles and pedestrians, either by bridging or otherwise, and shall not obstruct the sidewalks, gutters, or streets, nor prevent in any manner the flow of water in the latter, but shall use all proper and necessary means to permit the free passage of surface water along the gutters.**
 10. **The Contractor shall immediately cart away all offensive matter; exercising such precaution as may be directed by the County. All material excavated shall be so disposed of as to inconvenience the public and adjacent tenants as little as possible and to prevent injury to trees, sidewalks, fences and adjacent property of all kinds.**

C. BARRIER AND LIGHTS

1. **The Contractor shall exercise extreme care in the conduct of the Work to protect health and safety of the workmen and the public. The Contractor shall provide all protective measures and devices necessary, in conformance with applicable local, state and federal regulations regarding their need and use. Protective measures shall include but are not limited to barricades, warning lights/flashers and safety ropes.**
2. **All equipment and vehicles operating within 10-feet of the roadway shall have flashing strobe lights attached.**

D. DEWATERING AND FLOTATION

1. **The Contractor, with his own equipment, shall do all pumping necessary to dewater any part of the Work area during construction operations to insure dry working conditions. The Contractor shall be completely responsible for any tanks, wetwells or similar structures that may become buoyant during the construction and modification operations due to the ground water or floods and before the structure is put into operation. The proposed final structures have been designed against buoyancy; however the Contractor may employ methods, means and techniques during the various stages of construction (or other conditions), which may affect the buoyancy of structures. Should there be any possibility of buoyancy of a structure; the Contractor shall take the necessary steps to prevent its buoyancy either by increasing the structure's weight, by filling it with approved material or other acceptable methods. Damage to any structures due to floating or flooding shall be repaired or the structures replaced at the Contractor's expense.**
2. **Contractor shall be responsible for any required permits for the discharge of ground water.**

E. DUST AND EROSION CONTROL

1. **The Contractor shall prevent dust nuisance from his operations or from traffic by the use of water and deliquescent salts.**
2. **Erosion and Sedimentation Control**
 - a. Temporary erosion controls include, but are not limited to, grassing, mulching, netting, watering and reseeded on-site surfaces and soil and borrow area surfaces and providing interceptor ditches at ends of berms and at those locations which will ensure that erosion during construction will be either eliminated or maintained within acceptable limits as established by the County, FDEP and any other agency having jurisdiction.
 - b. Temporary sedimentation controls include, but are not limited to; silt dams, traps, barriers, and appurtenances at the foot of sloped surfaces which will ensure that sedimentation pollution will be either eliminated or maintained within acceptable limits as established by the County, FDEP and any other agency having jurisdiction.
 - c. The construction of temporary erosion and sedimentation control facilities shall be in accordance with the technical provision of section 104-6.4 of the 1991 Edition, FDOT Standard Specifications for Road and Bridge Construction.
 - d. Contractor is responsible for providing effective temporary erosion and sediment control measures during construction or until final controls become effective.

F. **LINES AND GRADES**

1. **All Work under this Contract shall be constructed in accordance with the lines and grades shown on the Drawings, or as given by the County/Professional. The full responsibility for keeping alignment and grade shall rest upon the Contractor.**
2. **The Contractor shall, at his own expense, establish all working or construction lines and grades as required from the project control points set by the County, and shall be solely responsible for the accuracy thereof.**
3. **Water main and forcemain shall have a minimum of 36-inches of cover over the top of the pipe. Cover shall vary to provide long uniform gradient or slope to pipe to minimize air pockets and air release valves. The stationing shown on the Drawings for air and vacuum release valve assemblies are approximate and the Contractor shall field adjust these locations to locate these valves at the highest point in the pipeline installed. All locations must be acceptable by the County.**
4. **To insure a uniform gradient for gravity pipe and pressure pipe, all lines shall be installed using the following control techniques as a minimum:**
 - a. Gravity lines; continuous control, using laser beam technology.
 - b. Pressure lines; control stakes set at 50-foot intervals using surveyors' level instrument.

G. **CUTTING AND PATCHING**

1. **The Contractor shall do all cutting, fitting or patching of his portion of the Work that may be required to make the several parts thereof join and coordinate in a manner satisfactory to the County and in accordance with the Drawings and Specifications.**
2. **Preparation:**

- a. Inspect the existing conditions of the Project, including elements subject to damage and/or movement during cutting and patching.
 - b. Provide adequate temporary support to assure the structural integrity of all facilities during completion of the Work.
3. **Performance:**
- a. Execute cutting and demolition by methods, which will prevent damage to other existing facilities and will provide proper surfaces to receive installation of equipment and repair.
 - b. Excavation and backfilling shall be performed in a manner, which will prevent settlement and/or damage to existing facilities.
 - c. All pipes, sleeves, ducts, conduits and other penetration through surfaces shall be made airtight.
 - d. Refinish entire surfaces as necessary to provide an even finish to match adjacent finishes.

H. TEMPORARY CONSTRUCTION

- 1. **Temporary fences: If, during the course of the Work, it is necessary to remove or disturb any fencing, the Contractor shall at his own expense, provide a suitable temporary fence which shall be maintained until the permanent fence is replaced. The County/Professional will be solely responsible for the determination of the necessity for providing a temporary fence and the type of temporary fence to be used.**
- 2. **Responsibility for Temporary Structures: In accepting the Contract, the Contractor assumes full responsibility for the sufficiency and safety of all temporary structures or work and for any damage which may result from their failure or their improper construction, maintenance or operation and will indemnify and save harmless the County from all claims, suits or actions and damages or costs of every description arising by reason of failure to comply with the above provisions.**

I. DAILY REPORTS

- 1. **The Contractor shall submit to the County's Representative daily reports of construction activities including non-work days. The reports shall be complete in detail and shall include the following information:**
 - a. Days from Notice to Proceed; Days remaining to substantial and final completion.
 - b. Weather information
 - c. Work activities with reference to the Critical Path Method (CPM) schedule activity numbers (including manpower, equipment and daily production quantities for each individual activity).
 - d. Major deliveries
 - e. Visitors to site
 - f. Test records
 - g. New problems, and
 - h. Other pertinent information
- 2. **A similar report shall be submitted for/by each Subcontractor.**
- 3. **The report(s) shall be submitted to the County Representative's Field Office within 2 days of the respective report date. Each report shall be signed by the**

Contractor's Superintendent or Project Manager. Pay request will not be processed unless daily reports are current.

4. **If a report is incomplete, in error, or contains misinformation, a copy of the report shall be returned by the County Representative to the Contractor's Superintendent or Project Manager with corrections noted. When chronic errors or omissions occur, the Contractor shall correct the procedures by which the reports are produced.**

J. CLEANING

1. **During Construction**

- a. During construction of the Work, the Contractor shall, at all times, keep the site of the Work and adjacent premises as free from material, debris and rubbish as is practicable and shall remove the same from any portion of the site if, in the opinion of the County, such material, debris, or rubbish constitutes a nuisance or is objectionable.
- b. Provide on-site containers for the collection of waste materials, debris and rubbish and remove such from the site periodically by disposal at a legal disposal area away from the site.
- c. Clean interior spaces prior to the start of finish painting and continue cleaning on an as-needed basis until painting is finished. Use only those cleaning materials which will not create hazards to health or property and which will not damage surfaces. Use only those cleaning materials and methods recommended by the manufacturer of the surface material to be cleaned. Schedule operations so that dust and other contaminants resulting from cleaning process will not fall on wet or newly coated surfaces.
- d. The Contractor shall remove from the site all surplus materials and temporary structures when no longer necessary to the Work at the direction of the County.

2. **Final Cleaning**

- a. At the conclusion of the Work, all equipment, tools, temporary structures and materials belonging to the Contractor shall be promptly taken away, and he shall remove and promptly dispose of all water, dirt, rubbish or any other foreign substances. Employ skilled workmen for final cleaning. Thoroughly clean all installed equipment and materials to a bright, clean, polished and new appearing condition. Remove grease, mastic, adhesives, dust, dirt, stains, fingerprints, labels, and other foreign materials from sight-exposed interior and exterior surfaces. Broom clean exterior paved surfaces; rake clean other surfaces of the grounds.
- b. The Work shall be left in a condition as shown on the Drawings and the remainder of the site shall be restored to a condition equal or better than what existed before the Work.
- c. Prior to final completion, or County occupancy, Contractor shall conduct an inspection of interior and exterior surfaces, and all work areas to verify that the entire Work is clean. The County will determine if the final cleaning is acceptable.

1.16 CONSTRUCTION NOT PERMITTED

A. USE OF EXPLOSIVES

- 1. No blasting shall be done except upon approval by the County and the governmental agency or political subdivision having jurisdiction. When the use of explosives is approved by the County as necessary for the execution of the Work, the Contractor shall use the utmost care so as not to endanger life or property, and assume responsibility for any such damage resulting from his blasting operations, and whenever directed, the number and size of the charges shall be reduced. All explosives shall be stored in a secure manner and all such storage places shall be marked clearly, "DANGEROUS EXPLOSIVES" and shall be in care of competent watchmen. All permits required for the use of explosives shall be obtained by the Contractor at his expense. All requirements of the governmental agency issuing permit shall be observed.**

PART 2 - PRODUCTS (NOT USED)

PART 3 - EXECUTION (NOT USED)

END OF SECTION

SECTION 01010
SUMMARY OF WORK

PART 1 - GENERAL

1.01 WORK COVERED BY CONTRACT DOCUMENTS

A. This Contract is for the rehabilitation of three (3) existing pump stations and the construction of two (2) new pump stations (including the subsequent demolition of the existing two (2) pump stations they are replacing), which includes furnishing all labor, equipment, and materials for the construction of the facilities consisting of, but not limited to the expansion of or improvements to the equipment and structures associated with the following:

1. Pump Station 3309 – Lena Street

Installation of a new protective liner within the existing wet well.

Installation of two (2) new wastewater submersible pumps.

Installation of a new wet well top slab with access hatch and vent, power cable, steel cable, float liquid level control sensors, discharge pipes and fittings.

Installation of a new valve vault top slab with access hatch and coating the interior of the valve vault.

Installation of new valve vault valves, piping and appurtenances.

Installation of an above ground emergency pump out connection and segment of force main.

Removal and replacement of electrical system including electrical service, a new control panel and reinstallation of the existing SCADA system.

Installation of 1-inch water service line, reduced pressure back flow preventer and hose bibb.

Installation of a concrete driveway and concrete pump station pad.

Installation of a concrete pump station curbing.

Installation of 4-inch FDOT #57 stone over 60-mil geofabric weed control liner on all unpaved exposed area within pump station curbing.

De-scale and CIPP line a segment of existing D.I. influent gravity sanitary sewer.

2. Pump Station 3365 – University at Rouse

Remove the existing wet well liner and install a new extended protective liner within the existing wet well.

Remove the existing valve vault, meter vault and associated fittings, valves and piping.

Raise and grade the pump station site and the adjacent ground to the elevations shown on the Drawings.

Raise the top elevation of the existing sanitary manhole to the elevation shown on the Drawings and coat the interior of the manhole.

Installation of two (2) new wastewater submersible pumps.

Installation a cast-in-place concrete riser and a new wet well top slab with liner, access hatch, above grade piping outlets, vent, power cable, steel cable, float liquid level control sensors, discharge pipes and fittings.

Installation of above grade discharge piping, concrete slab with pipe supports, piping, valves and appurtenances.

Installation of a 12-inch by 8-inch tapping sleeve and valve, above ground emergency pump out connection and segment of 8-inch force main.

Removal and replacement of electrical system including electrical service, a new control panel and reinstallation of the existing SCADA system.

Installation of a water meter, 1-inch water service line, reduced pressure back flow preventer and hose bibb.

Installation of concrete driveways, sidewalk, curb and gutter, and concrete pump station pad.

Installation of concrete pump station curbing.

Installation of black vinyl coated chain link fence inside concrete curbing with 4 inch reveal all around and double swing gate.

Installation of 4-inch FDOT #57 stone over 60-mil geofabric weed control liner on all unpaved exposed area within pump station curbing.

Installation of chain link fencing in areas outside the pump station site including a double swing gate at the storm water pond entrance driveway

Place the existing 8-inch force main out of service by grout filling and removing the 16-inch aerial crossing over the Little Econ. River.

De-scale and CIPP line two segments of existing D.I. influent gravity sanitary sewer.

3. **Pump Station 3887 – Greenview Pines**

Installation of a new six (6) foot diameter HDPE lined wet well.

Installation of two (2) new wastewater submersible pumps.

Installation of access hatch, power cable, steel cable, float liquid level control sensors, discharge pipes and fittings and wet well ventilation system.

Installation of an underground valve vault with above ground emergency pump out system.

Removal and replacement of electrical system including a new control panel.

Installation of approximately 10 lineal feet of 4-inch PVC forcemain.

Installation of 1-inch water service with reduced pressure back flow preventer.

Installation of a 14 foot driveway.

Installation of ± 73 lineal feet of 6 foot black vinyl coated chain link fence along the new concrete driveway.

Installation of ± 103 lineal feet of 6 foot black vinyl coated chain link fence inside concrete curb with 4 inch reveal all around and one (1) 14 foot wide double 7 foot panels swing gate.

Installation of 4-inch FDOT #57 stone over 60-mil geofabric weed control liner on all unpaved exposed area within pump station fence.

Rehabilitation of two (2) existing manholes.

Demolish existing pump station.

4. **Pump Station 3890 -Bradford Cove**

Clean and rehabilitate existing wet well with new elevation, protective liner and concrete top.

Installation of two (2) new wastewater submersible pumps.

Installation of access hatch, power cable, steel cable, float liquid level control sensors, discharge pipes and fittings and wet well ventilation system.

Installation of a new above ground valves with emergency pump out system.

Removal and replacement of electrical system including a new control panel.

Installation of approximately thirty (30) lineal feet of 4-inch PVC forcemain.

Installation of 1-inch water service with reduced pressure back flow preventer.

Installation of a 14 foot driveway.

Removal of 132 lineal feet of chain link fence with curb and one (1) 14 foot gate.

Installation of \pm 160 lineal feet of 6 foot black vinyl coated chain link fence inside concrete curb with 4 inch reveal all around and one (1) 14 foot wide double 7 foot panels swing gate.

Installation of 4-inch FDOT #57 stone over 60-mil geofabric weed control liner on all unpaved exposed area within pump station fence.

Rehabilitate one (1) existing manhole.

Demolish existing valve vault.

Raise and grade the site to elevations shown on the Drawings.

Grading of site to provide positive drainage as shown on the Drawings.

5. Pump Station 3893A – Allison Oaks (replacement for PS 3893)

Installation of a new six (6) foot diameter HDPE lined wet well.

Installation of two (2) new wastewater submersible pumps.

Installation of access hatch, power cable, steel cable, float liquid level control sensors, discharge pipes and fittings and wet well ventilation system.

Installation of an underground valve vault with above ground emergency pump out system.

Removal and replacement of electrical system including a new control panel.

Installation of approximately \pm 90 lineal feet of 4-inch PVC forcemain.

Installation of six (6) new manholes

Installation of approximately \pm 302 lineal feet of 8-inch PVC gravity main.

Installation of a two service lateral.

Installation of 1-inch water service with reduced pressure back flow preventer.

Installation of a 16 foot driveway.

Removal and installation of \pm 107 lineal feet of chain link fence.

Installation of 4-inch FDOT #57 stone over 60-mil geofabric weed control liner on all unpaved exposed area within pump station fence.

Rehabilitate two (2) existing manholes.

Clean, grout and plug approximately 293 lineal feet of existing 8-inch gravity main.

Clean, grout and plug approximately 120 lineal feet of existing 4-inch forcemain.

Demolition of one (1) existing manhole.

Demolish existing pump station

Pavement restoration

1.02 WORKING HOURS

- A. Working hours for the County Inspector are an 8-hour period between the hours of 7:00 a.m. and 4:00 p.m., Monday through Friday. Any work beyond the 8-hour period is to be requested in writing 48 hours prior and paid for by the Contractor. Any work required on Saturday, Sunday or Holidays shall be requested in writing 48 hours in advance. All requests must be submitted to the County and approved by the County in advance. Under emergency situations, a verbal request may be made with a follow-up written request.
- B. The Contractor shall pay the County for County Inspector time outside of normal Working Hours at a rate of \$51.00/hour. The Contractor agrees that the County shall deduct such charges from the Contract Amount by a deductive Change Order.

1.03 CONTRACTOR'S USE OF PREMISES

- A. The Contractor shall assume full responsibility for the protection and safekeeping of products and materials at the job site. If additional storage or work areas are required, they shall be obtained by the Contractor at no additional cost to the Owner.

1.04 SEQUENCE OF WORK

- A. The Contractor shall establish his work sequence based on the use of crews to facilitate completion of construction and testing within the specified Contract Time.
- B. The sequence of demolition and renovation of the existing facilities will be in accordance with the approved demolition and removal plan. Below is basic outline of project sequence at each of the pump stations which may be used as the basis for Contractor's detailed sequence of construction.

C.

1. **Pump Station 3309 – Lena Street**

Install silt fencing, and clear and grub pump station site and adjacent area.

Install new water service line, backflow preventer and hose bibb.

Install emergency pump out connection, upstream plug valve and connect to existing force main.

By-pass flow from wet well to emergency pump out connection.

De-scale and CIPP line segment of influent gravity sewer pipe.

Remove existing valve vault, top slab, valves and piping

Coat existing valve vault, install new valves, piping and appurtenances and install new top slab.

Remove existing wet well top slab, pumps, piping, rails and equipment.

Line existing wet well, install new pumps, piping and equipment; and install new top slab.

Install new electrical service and remove existing electrical system including rack and panels.

Install new electrical rack, panels and relocate existing SCADA panel.

Grade site, construct driveway, concrete pad and concrete curbing.
Install crushed stone, sod disturbed areas and remove silt fencing.

2. Pump Station 3365 – University at Rouse

Install silt fencing.

De-scale and CIPP line two segments of influent gravity sewer pipe.

Remove existing pump station and pond site fencing.

Clear and grub pump station site and adjacent area.

Raise elevation of existing sanitary manhole to final grade.

Wet tap existing 12-inch force main, install new 8-inch force main and install emergency pump out connection.

By-pass flow from wet well to emergency pump out connection.

Remove existing valve vault, meter vault, valves and piping.

Remove existing site pavement and driveways.

Remove exiting electrical rack and panels.

Remove existing wet well top slab, equipment from wet well, remove existing liner from wet well.

Re-line and re-equip wet well, install new top slab and riser.

Fill pump station site and adjacent area to approximate final grades.

Install new electrical service, new electrical rack, control panel and relocate SCADA panel.

Install water meter, water service line, reduced pressure backflow preventer and hose bibb.

Final grade site, construct concrete pads, driveways, sidewalks, pump station fencing with gates and concrete curbing, and pond fencing with gates.

Install crushed stone, sod disturbed areas and remove silt fencing.

3. Pump Stations 3887 – Greenview Pines and PS 3890 – Bradford Cove

Install temporary bypass of pump stations by providing pumping systems at the upstream manholes for the two pump stations. Temporary force main from pumping system will discharge to the existing force mains downstream of the pump stations through a wet-tap connection.

Remove existing pumps, structures, control panels, piping, vaults and appurtenances.

Construct wet well and / or vault, influent gravity piping (if needed) and discharge piping improvements.

Install new electrical controls.

Complete start-up and testing of the pump station improvements

Discontinue bypass pumping and place modified pump stations in service.

Complete site work, entrance drive and fencing for the pump stations.

4. Pump Station 3893A – Allison Oaks (replacement of PS 3893)

Construct the proposed pump station wet well, valve vault, pumping system, influent gravity sewer, effluent force main, electrical and instrumentation and site work.

Complete start-up and testing for the new pump station 3893A.

Install bypass pumping from the existing upstream manhole of PS 3893 with temporary force main piping to tie into the proposed emergency pump connection and force main for PS 3893A.

Connection of gravity sewer piping to the PS 3893A and Demolition of PS 3893.

Discontinue bypass pumping and place PS 3893A in service.

Complete site work, entrance drive and fencing for PS 3893A.

1.05 PUBLIC UTILITY INSTALLATIONS AND STRUCTURES

- A. The Contractor shall give written notice to all governmental utility departments and other owners of public utilities of the location of the proposed construction operations, at least seventy-two hours in advance of breaking ground in any area or on any unit of the Work.
- B. Some of the utility contacts are listed on the plans for the Contractor's convenience.
- C. The maintenance, repair, removal, relocation or rebuilding of the public utility installation and structures, when accomplished by the Contractor as herein provided, shall be done by methods approved by the utility involved.

PART 2 - PRODUCTS (NOT USED)

PART 3 - EXECUTION (NOT USED)

END OF SECTION

SECTION 01021
SOILS REPORT AND OTHER INFORMATION

PART 1 - GENERAL

1.01 REQUIREMENTS INCLUDED

- A. Identification of reports of existing conditions.

Bidder's/Contractor's responsibilities for investigating and working with existing conditions.

1.02 LAND IN-ADDITION TO THE SITE

- A. Contractor is responsible for obtaining any lands, areas, properties, facilities and easements, in addition to those furnished by the County, that the Contractor considers necessary for temporary facilities, storage, disposal of spoil or waste material or other purposes the Contractor determines necessary to complete the Work. Contractor shall provide written documentation from owner to use such land or facilities. The County/Professional and the Geotech do not assume any responsibility for existing conditions at such lands, areas, properties, facilities and /or easements obtained by the Contractor.

1.03 SUBSURFACE CONDITIONS AND OTHER PHYSICAL CONDITIONS

- A. This Section identifies reports of explorations and tests of subsurface conditions, and drawings of physical conditions of existing surface and subsurface structures that have been used in the preparation of the Contract Documents. Contractor may rely upon any technical information and data in those reports found in Appendix A, "Geotechnical Report (includes geotechnical investigation and dewatering ground water quality values per Chapter 62-621, paragraph 62-621.300(2), F.A.C.)." The Report(s) in Appendix A is designated as Authorized Technical Data, but those reports and drawings are not part of the Contract Documents.
- B. Any conclusions or interpretations made by the Contractor based on any Authorized Technical Data will be at the Contractor's own risk. Contractor's reliance on any non-technical information, data, interpretations or opinions also will also be at Contractor's own risk. The County/Professional assume no responsibility for any understanding reached or representation made about subsurface conditions and physical conditions of existing structures, except as otherwise expressly shown in or represented by the Authorized Technical Data provided.

- C. The only information or data contained in the geotechnical report and used in the preparation of the Contract Documents that may be properly considered authorized technical data concerning subsurface conditions is found in Appendix A "Geotechnical Report". Such technical data are made available to allow the Contractor to have access to the same information available to the County. The County/Professional do not warrant the accuracy or completeness of any such information or that the Contract Documents identify all the existing relevant reports and/or documents.

1.04 UNDERGROUND UTILITIES

- A. Information or data about physical conditions of Underground Utilities, which have been used in the preparation of the Contract Documents, is shown or indicated in the Drawings and technical specifications. Such information and data is based on information and data obtained from record documents or furnished to the County by the owners of those Underground Utilities or by others.

PART 2 - PRODUCTS (NOT USED)

PART 3 - EXECUTION

3.01 EXISTING GROUND SURFACE AND UNDERGROUND CONDITIONS; GENERALLY

- A. Where existing ground conditions are shown on the plans hereto attached, the elevations are believed to be reasonably correct but are not guaranteed to be absolutely so, and, together with any schedule of quantities, are presented only as an approximation. The Contractor shall satisfy itself, however, by actual examination of the site of the Work, as to the existing elevations and the amount of work required under the Contract.
- B. Where test pits and borings have been dug, the results supplied to the County/Professional by the soils Engineer may be given on the plans or are on file in the County/Professional's office and available for review . The County does not guarantee the accuracy or correctness of this information. If the Contractor desires any additional information relating to the soils investigation, contact the County/Professional to obtain such information. County does not guarantee the accuracy or correctness of any such information supplied to the Contractor.

- C. If, upon notice of a differing subsurface or latent physical condition from the Contractor, the County determines there was no unforeseen condition and unnecessary tests and investigations were conducted solely at the Contractor's request, any unnecessary expenses may be deducted from the Final Payment for the Contract. No increase in Contract Amount or Contract Time will be made if the differing site conditions were known or could have been discovered by the types of examinations that the Contractor, as Bidder, was responsible for. Claims based on groundwater table conditions will not be considered unforeseen subsurface conditions and will not be allowed. Any information indicated in the Contract Documents as to the groundwater table conditions has been provided for general information purposes only and is not intended to represent that the same conditions will exist during the execution of the Work. Further, no increase in Contract Amount or Contract Time will be made for costs incurred prior to the Contractor's written notice as required by the Contract Documents. The County will be allowed at least 10-days to investigate any alleged differing site conditions and to take appropriate action, before the Contractor is entitled to any adjustment in Contract Amount or Contract Time for Delay.

3.02 UNDERGROUND UTILITIES:

- A. The Contractor will be responsible for the safety and protection of, and providing for the repair of any damage done to the Work and existing surface and subsurface structures. The Contractor will be responsible for any damages and injury resulting from the failure to excavate in a careful and prudent manner.
- B. Contractor shall have full responsibility for locating all underground pipelines, conduits, ducts, cables, wires, manholes, vaults, tanks, tunnels, or other such facilities or attachments, and any encasements containing such facilities, including those that convey electricity, gases, steam, liquid petroleum products, telephone or other communications, cable television, water, wastewater, stormwater, other liquids or chemicals, or traffic or other control systems, shown or indicated in the Contract Documents, in advance of construction, coordinating the Work with the actual locations found and making note of the actual locations on the record Drawings. Contractor shall exercise extreme caution when locating underground facilities to minimize the risk of damage from Contractor's activities. The Contractor will immediately notify the County and the owner of any Underground Utilities that are inaccurately identified or located on the Drawings.
- C. The Contractor will be responsible for any delay and all costs relating to the obligations set forth in this Section, except as provided by allowances specific to Underground Utilities.
- D. The Contractor will promptly notify the County, in writing, whenever the Contractor discovers that actual physical conditions of Underground Utilities differ materially from those indicated by the Contract Documents or Authorized Technical Data provided with the Contract Documents. Further, the Contractor promptly will notify the County, in writing, whenever the Contractor encounters Underground Utilities not shown or indicated in/through the Contract Documents, and which could not reasonably have been foreseen.

- E. The County and Contractor will follow the provisions of the General Conditions with respect to any conclusions reached by the County after the County compares the actual underground utility conditions with those included in the information provided to the Contractor.

3.03 ENVIRONMENTAL PROCEDURES FOR HAZARDOUS MATERIALS

- A. The Contractor will not, at any time, cause or permit any Hazardous Materials to be brought upon, stored, manufactured, blended, handled, or used in, on, or about the Project or the Site for any purpose except as lawful and necessary and in accordance with the Contract Documents. The Contractor will not cause or permit Hazardous Materials to be brought on Site unless they have been specifically pre-identified by the Contractor, and approved in writing in advance by the County.
- B. The Contractor will defend, save, indemnify and hold harmless the County, their agents and employees from and against all liabilities, claims, damages, losses and expenses including attorneys' fees, which arise at any time during or after completion of the Work as a result of or in connection with:
 - 1. The Contractor's breach of any prohibition or requirement set forth in this Section or,
 - 2. Any Hazardous Materials discharged, released, deposited or introduced in the soil or surface or groundwater in, on, under, or about the Work, the Site or other properties as a result of the activities of the Contractor, the Subcontractors and their respective agents and employees in connection with the Work.
- C. This Contractor's indemnity obligation includes without limitation, costs incurred in connection with any investigation of site conditions or any cleanup, remediation, removal, or restoration required by the County or any federal, State, or local Public Agency because of:
 - 1. The occurrence of any Hazardous Materials present in the soil or surface or groundwater in, on, under, or about the Work or the Site;
 - 2. The diminution in value of the Work or the Site;
 - 3. Damages for the loss or restriction on use of the Work or of any amenity of the Work or the Property; and/or
 - 4. Amounts paid in settlement of claims, penalties, attorneys' fees, court costs, consultant and laboratory fees and experts' fees.
- D. The Contractor will immediately notify the County in writing of any significant release of Hazardous Materials at the Project or the Site, specifying the nature and quantity of the release, the location of the release, and the measures taken to contain and clean up the release and ensure that future releases do not occur.
- E. The Contractor agrees that insulation and any other construction materials containing asbestos or urea formaldehyde will not be used on the Work, and that all Sub-agreements will prohibit the use of construction materials (including, but not limited to, insulation) containing asbestos or urea formaldehyde.

3.04 DIFFERING HAZARDOUS MATERIAL CONDITIONS:

- A. If the Contractor unexpectedly encounters material reasonably believed to be Hazardous Material, the Contractor will immediately stop all affected Work, give written notice to the County and take appropriate health and safety precautions. Unless the Contract Documents require otherwise, the Contractor will conduct an investigation. If upon due investigation, the Contractor determines the material a Hazardous Material that may present a danger to persons or the surroundings, the Contractor will recommend a solution to the County. In any such case, the affected Work will be considered to have been under a suspension of Work.
- B. If the Hazardous Material is not required Work under the Drawings and/or Specifications, the County will proceed to have the Hazardous Material removed or rendered harmless through a Change Order or by means of another contract or as the County otherwise deems expedient. Alternatively, the County will terminate the affected Work or Contract for the County's convenience.
- C. If the County did not elect termination, once the Hazardous Material has been removed or rendered harmless, the affected Work will be resumed as directed in writing by the County. Any determination by the Florida Department of Community Health or the Department of Environmental Quality that the Hazardous Material has been removed or rendered harmless will be binding upon the County and Contractor for the purposes of resuming the affected Work.
- D. If the Contractor is responsible for the Hazardous Material, the Contractor will bear its proportionate share of the delay and costs involved in cleaning up the Site and removing and rendering it harmless to the satisfaction of the County and all Political Subdivisions with jurisdiction. The Contractor will be solely responsible if the Hazardous Material was brought to the Site by the Contractor, or results in whole or in part from any violation by the Contractor of any applicable Laws.
- E. If the Contractor is responsible, but fails to take appropriate action, and the County acts accordingly, the Contractor will defend, save, indemnify and hold harmless the County from and against all claims arising from the County's exercise of appropriate action.
- F. If the Contractor is not responsible, the County will issue a Change Order with the necessary changes. The Change Order will adjust Contract Amount and/or Contract Time as made necessary by the changes and resulting unreasonable delay under the circumstances attributable to the County /Professional.

3.05 INCIDENTS WITH ARCHAEOLOGICAL FEATURES:

- A. The Contractor will immediately notify in writing, the County and all Federal, State and local agencies with jurisdiction of any Archaeological Feature deposits encountered or unearthed. The Contractor will protect such Archaeological Features in a proper and satisfactory manner. No further disturbance of the Archaeological Features will take place until work is allowed to resume in the affected areas.

- B. If the County concludes that the Contract Documents require changes because of Archaeological Feature deposits encountered, the County will issue a Change Order with the necessary changes in the Work. The Change Order also will adjust Contract Amount and/or Contract Time as made necessary by those changes and by any resulting unreasonable delay under the circumstances attributable to the County/Professional.

END OF SECTION

SECTION 01025
MEASUREMENT AND PAYMENT

PART 1 - GENERAL

1.01 REQUIREMENTS INCLUDED

This Section specifies administrative and procedural requirements to define pay items and determine payable amounts, and includes but is not limited to:

1. General Provisions
2. Work Not Paid for Separately
3. Measurement for Payment
4. Partial Payment for Stored Materials and Equipment

1.02 GENERAL PROVISIONS

This specification includes standard descriptions for all bid items. This Contract's specific bid items are listed in the Bid Schedule.

The total Contract Amount shall cover the Work required by the Contract Documents. All costs in connection with the successful completion of the Work, including furnishing all materials, equipment, supplies, and appurtenances; providing all construction, equipment, and tools; and performing all necessary labor and supervision to fully complete the Work, shall be included in the unit and lump sum prices bid. All Work not specifically set forth as a pay item in the Bid Form shall be considered a subsidiary obligation of the Contractor and all costs in connection therewith shall be included in the prices bid.

If used, all estimated quantities stipulated in the Bid Schedule or other Contract Documents are approximate and are to be used only (a) for the purpose of comparing the bids submitted for the Work, and (b) as a basis for determining an initial Contract Amount. The actual amounts of Work completed and materials furnished under unit price items may differ from the estimated quantities. The County does not expressly or by implication represent that the actual quantities involved will correspond exactly to the quantities stated in the Bid Schedule; nor shall the Contractor plead misunderstanding or deception because of such estimate or quantities or of the character, location or other conditions pertaining to the Work. Payment to the Contractor will be made only for the actual quantities of work performed or material furnished in accordance with the Drawings and other Contract Documents, and it is understood that the quantities may be increased or decreased as provided in the General Conditions.

If used, the unit prices listed in the Bid Schedule shall include all services, obligations, responsibilities, labor, materials, devices, equipment, royalties and license fees, supervision, temporary facilities, construction equipment, bonds, insurance, taxes, clean up, traffic control, control surveys, field offices, close out, overhead and profit and all connections, appurtenances and any other incidental items of any kind or nature, as are necessary to complete the Work in accordance with the Contract Documents.

Except for mobilization/demobilization and project record documents, payment for Work will be based on the percent of completed work of each item in the Schedule of Values, including stored materials, as determined by the County. Progress of work in each item of the Schedule of Values will be determined separately by the County. However, the County will issue a single payment certificate for progress on the Contract.

The Contractor agrees that it will make no claim for damages, anticipated profits, or otherwise because of any difference between the amounts of work actually performed and materials actually furnished and the estimated amounts therefore.

Where payment by scale weight is specified under certain items, the Contractor shall provide suitable weighing equipment which shall be kept in accurate adjustment at all times and certified. The weighing of all material shall be performed by the Contractor in the presence and under the supervision of the County.

All schedules included in the Contract Documents are given for convenience and are not guaranteed to be complete. The Contractor shall assume all responsibility for the making of estimates of the size, kind, and quantity of materials and equipment included in work to be done under this Contract.

Where pipe fittings are noted on the Drawings, such notation is for the Contractor's convenience and does not relieve the Contractor from laying and jointing different or additional items where required.

1.03 WORK NOT PAID FOR SEPARATELY

Delivery: Payment for equipment delivery, storage or freight shall be included in the pay items including their installation and no other separate payment will be made therefore.

Bonds: Payment for bonds required by the Contract shall be included in the pay items for the Work covered by the required bonds and no separate payment will be made.

Preparation of Site: Payment for preparation of site shall be included in pay items proposed for the various items of Work and no separate payment will be made therefore. Preparation of site includes setting up construction plant, offices, shops, storage areas, sanitary and other facilities required by the specifications or state law or regulations; providing access to the site; obtaining necessary permits and licenses; payments of fees; general protection, temporary heat and utilities including electrical power; providing shop and working drawings, certificates and schedules; providing required insurance; cleaning up; and all other work regardless of its nature which may not be specifically referred to in a Bid Item but is necessary for the complete construction of the project set

forth by the Contract.

Permitting & Permit Fees.

The County reserves the right to delete any item included in the Schedule of Values and decrease the Contract Price by the scheduled amount for the item deleted.

1.04 MEASUREMENT FOR PAYMENT

Methods of Measurement - Generally:

1. Units of measurement shall be defined in general terms as follows:
 - a. Linear Feet (LF)
 - b. Square Feet (SF)
 - c. Square Yards (SY)
 - d. Cubic Yards (CY)
 - e. Each (EA)
 - f. Sacks (SK)
 - g. Lump Sum (LS)
2. Unit Price Contracts/Items:
 - a. Linear Feet (LF) shall be measured along the horizontal length of the centerline of the installed material, unless otherwise specified. Pipe shall be measured along the length of the completed pipeline, regardless of the type of joint required, without deduction for the length of valves or fittings. Pipe included within the limits of lump sum items will not be measured.
 - b. Square Feet (SF), Square Yards (SY), Cubic Yards (CY), Each (EA) and Sacks (SK) shall be measured as the amount of the unit of measure installed and compacted within the limits specified and shown in the Specifications and Drawings. Slope angles and elevations shall be measured using land-surveying equipment. Contractor shall provide supporting documentation (i.e. drawings, delivery tickets, invoices, survey calculations, etc.) to verify actual installed quantities.

Lump Sum Contracts/Items - Generally:

3. Quantities provided in the Schedule of Values are for the purpose of estimating the completion status for progress payments. Payment will be made for each individual item on a percentage of completion basis as estimated by the Contractor and approved by the County.
4. Adjustments to costs provided in the accepted Schedule of Values may be made only by Change Order.
5. The County reserves the right to delete any item included in the Schedule of Values and decrease the Contract Price by the scheduled amount for the item deleted.

1.05 MEASUREMENT AND PAYMENT ITEMS

Only those bid items included in the Bid Schedule are applicable for this Contract. The County has standardized the measurement and payment items. Currently, there are approximately 100 measurement and payment items describing approximately 300 bid

items. The bid item numbering system comprises five sections that are divided into 23 subsections. The sections and subsections are listed below.

- 10. General Requirements
 - 10.1 General
- 11. Site Work
 - 11.1 Miscellaneous
 - 11.2 Road Work
 - 11.3 Install/Replace Fence or Wall
 - 11.4 Bypass Pumping
 - 11.5 Abandon or Remove Pipe/Structure
- 12. Pressure Pipes
 - 12.1 Pressure Pipe and Fittings and Restrained Joints
 - 12.2 Valves
 - 12.3 Tapping Sleeve and Valve Assembly
 - 12.4 Cut-in Connections to Existing Main
 - 12.5 Piping Appurtenances
 - 12.6 Directional Drill
 - 12.7 Pipe Bursting
- 13. Wastewater Collection System
 - 13.1 Cleaning Sanitary Sewers
 - 13.2 CCTV Sanitary Sewers
 - 13.3 Install/Replace Sanitary Sewer
 - 13.4 Install/Replace Sanitary Manholes
 - 13.5 Sanitary Manhole Rehabilitation
 - 13.6 Sanitary Service Laterals and Cleanouts
 - 13.7 Cured-in-Place Pipe (CIPP) Liner
 - 13.8 Sanitary Sewer Pipe Bursting
- 14. Pump Stations
 - 14.1 Wastewater Duplex Pump Station
 - 14.2 Wastewater Triplex Pump Station

All of the subsections have bid item measurement and payment descriptions. Several bid items in the Project Bid Schedule may be described with the same bid item measurement and payment description in Table A, "Measurement and Payment Items". The bid items in the Project Bid Schedule are related to the Section 01025 measurement and payment items as follows:

1. All of the bid items in the Project Bid Schedule have 8 numerical digits.
2. Table A, "Measurement and Payment Items" for each of the bid items there are five numerical digits followed by ".xxx".
3. The first 5 numerical digits of the bid item in the Project Bid Schedule designate the measurement and payment item found in Table A, "Measurement and Payment Items."

Table A

BID ITEM	Orange County Utilities MEASUREMENT AND PAYMENT ITEMS <small>Pg 1</small>
	14 PUMP STATION
	14.1 – Wastewater Duplex Pump Station
1	Reference ID 14.110.110 Duplex Pump Station (Allison Oaks PS #3893)
	<p>a. Measurement: Measurement for this item shall be based on satisfactory construction of the new Pump Station, demolition of the existing pump station, installation of new gravity sewer and manholes complete and ready for continuous operation as shown on the Drawings and specified herein.</p> <p>b. Payment: Payment of the applicable Contract lump sum price as stated in the proposal will be full compensation for furnishing all labor, materials, and equipment necessary to construct a pump station, demolish an existing pump station, install new gravity sewer and manholes, and provide bypass pumping as indicated on the Drawings. Work includes but is not necessarily limited to the following: pump station improvements including wetwell, top slab, valve vault, pumps, motors, control panel, SCADA control panel, SCADA pole, cables, rails, valves, water service connection, pressure piping and appurtenances as shown on the Drawings. All coordination with the electric power company, materials, equipment, tools, labor and fees to install an electrical service connection. Installation of all site and adjacent improvements noted on drawings including driveways and driveway connections, fencing with curb and gate, masonry walls and gates, asphalt and concrete paving, rock fill and sodding. All work required to construct, complete start-up testing and deliver a complete operational Pump Station without interruption of service.</p> <p>Payment for General Requirements (Section 01001) shall include bonds, permits, and required insurance, project signs, preconstruction audio-video documentation, maintenance of traffic, public information officer, and any other preconstruction expense necessary for the start of the work shall also be included. This Work also consists of the general project management of the Work including but not limited to, field supervision and office management, as well as other incidental cost for management of the Work during duration of the Contract. This work also includes maintenance of the field offices for the duration of the Contract.</p> <p>Measurement for various items covered under General Requirements, will not be made for payment, and all items shall be included in the lump sum price. This item will be paid upon each payment request made by the Contractor. The Contractor shall attach with the pay request invoices to substantiate the appropriate insurance and bonds have been obtained by the Contractor.</p>

	<p>Payment for Mobilization/Demobilization shall include Work consisting of the preparatory Work and operations in mobilizing for beginning Work on the Contract, including, but not limited to, movement of those personnel, equipment, supplied and incidentals to the project site, preparation of submittals, and for the establishment of temporary offices and buildings, safety equipment and first aid supplies, project signs, field surveys, sanitary and other facilities required by these specifications, and State and local laws and regulations. The Work specified in this item also consists of demobilization or the operations normally involved in ending Work on the project including, but not limited to termination and removal of temporary utility service and field offices; demolition and removal of temporary structures and facilities; restoration of the Contractor storage areas; disposal of trash and rubbish, and any other post-construction work necessary for the proper conclusion of the Work. This pay item may not exceed 5% of the Total Base Bid amount.</p> <p>Payment for Project Record Documents (Section 01720) shall be based on satisfactory progress of the Contractor to provide Project Record Documents including the certified as-built survey, in accordance with the County requirements and specifications. This pay item shall be a minimum of 1% of the Total Base Bid amount.</p> <p>Payment for Indemnification: In consideration of the Contractor's Indemnity Agreement as set out in the Contract Documents, County specifically agrees to give the Contractor \$20.00 and other good and valuable consideration, receipt of which is acknowledged upon signing of the Agreement.</p>
2	Reference ID 14.110.111 Duplex Pump Station (Greenview Pines PS #3887)
	<p>a. Measurement: Measurement for this item shall be based on satisfactory construction of the new Pump Station, demolition of the existing pump station, installation of new gravity sewer and manholes complete and ready for continuous operation as shown on the Drawings and specified herein.</p> <p>b. Payment: Payment of the applicable Contract lump sum price as stated in the proposal will be full compensation for furnishing all labor, materials, and equipment necessary to construct a pump station, demolish an existing pump station, install new gravity sewer and manholes and provide bypass pumping as indicated on the Drawings. Work includes but is not necessarily limited to the following: pump station improvements including wetwell, top slab, valve vault, pumps, motors, control panel, SCADA control panel, SCADA pole, cables, rails, valves, water service connection, pressure piping and appurtenances as shown on the Drawings. All coordination with the electric power company, materials, equipment, tools, labor and fees to install an electrical service connection. Installation of all site and adjacent improvements noted on drawings including driveways and driveway connections, fencing with curb and gate, masonry walls and gates, asphalt and concrete paving, rock fill and sodding.</p>

All work required to construct, complete start-up testing and deliver a complete operational Pump Station without interruption of service.

Payment for General Requirements (Section 01001) shall include bonds, permits, and required insurance, project signs, preconstruction audio-video documentation, maintenance of traffic, public information officer, and any other preconstruction expense necessary for the start of the work shall also be included. This Work also consists of the general project management of the Work including but not limited to, field supervision and office management, as well as other incidental cost for management of the Work during duration of the Contract. This work also includes maintenance of the field offices for the duration of the Contract.

Measurement for various items covered under General Requirements, will not be made for payment, and all items shall be included in the lump sum price. This item will be paid upon each payment request made by the Contractor. The Contractor shall attach with the pay request invoices to substantiate the appropriate insurance and bonds have been obtained by the Contractor.

Payment for Mobilization/Demobilization shall include Work consisting of the preparatory Work and operations in mobilizing for beginning Work on the Contract, including, but not limited to, movement of those personnel, equipment, supplied and incidentals to the project site, preparation of submittals, and for the establishment of temporary offices and buildings, safety equipment and first aid supplies, project signs, field surveys, sanitary and other facilities required by these specifications, and State and local laws and regulations. The Work specified in this item also consists of demobilization or the operations normally involved in ending Work on the project including, but not limited to termination and removal of temporary utility service and field offices; demolition and removal of temporary structures and facilities; restoration of the Contractor storage areas; disposal of trash and rubbish, and any other post-construction work necessary for the proper conclusion of the Work. This pay item may not exceed 5% of the Total Base Bid amount.

Payment for Project Record Documents (Section 01720) shall be based on satisfactory progress of the Contractor to provide Project Record Documents including the certified as-built survey, in accordance with the County requirements and specifications. This pay item shall be a minimum of 1% of the Total Base Bid amount.

Payment for Indemnification: In consideration of the Contractor's Indemnity Agreement as set out in the Contract Documents, County specifically agrees to give the Contractor \$20.00 and other good and valuable consideration, receipt of which is acknowledged upon signing of the Agreement.

3	Reference ID 14.120.110 Duplex Pump Station Rehabilitation (University at Rouse PS #3365)
	<p>a. Measurement: Measurement for this item shall be based on satisfactory rehabilitation of the existing Pump Station and the adjacent sanitary sewer collection system complete and ready for continuous operation. This item also includes the abandonment of the existing force main system by grout filling the 8-inch diameter segments of pipe and removing the 16-inch diameter aerial river crossing segments of pipe.</p> <p>b. Payment: Payment of the applicable Contract lump sum price as stated in the proposal will be full compensation for furnishing all labor, materials, and equipment necessary to rehabilitate the existing pump station and adjacent sanitary sewer collection system, in addition to abandoning the existing force main as indicated on the Drawings. Work includes but is not necessarily limited to the following: Rehabilitate the existing wet well including removing existing liner and installing new extended protective liner, install a cast-in-place concrete riser and a new lined wet well top slab, install an above grade discharge piping system, install all pumps, motors, control panel, cables, rails, valves, fittings, wet tap, pressure and gravity sanitary sewer piping and appurtenances as shown on the drawings. All maintenance of traffic, clearing and grubbing, fill material, grading, wastewater by-pass pumping, pumper trucks, erosion and sedimentation prevention and control. All demolition, removal, disposal, salvage and abandonment of existing facilities and structures including fencing, concrete driveways and pads, asphalt paving, the mechanical and electrical contents of the wet well and the damaged portions of the existing wet well liner, the existing wet well top slab, the existing valve vault, meter vault and associated piping, valves and fittings as noted in the Drawings including tie-ins, intercepts, removal and abandonment of piping, conduits and electrical services. All coordination, materials and equipment, tools, and labor to relocate the existing SCADA control panel, install a water meter, and water service connection. All coordination with the electric power company, materials, equipment, tools, labor and fees to install an electrical service connection. Installation of all site and adjacent improvements noted on drawings including concrete driveways and driveway connections, concrete sidewalk, fencing with curb and gates, concrete paving, rock fill and sodding. All materials, equipment, tools, and labor to de-scale and line (CIPP) the adjacent existing sanitary sewer collection system, and raise/ rehabilitate and coat the existing manhole indicated on the Drawings. All work required to construct, complete start-up testing, and deliver a complete operational Pump Station, rehabilitate the adjacent wastewater collection system, and abandon the existing force main without interruption of service.</p>

	<p>Payment for General Requirements (Section 01001) shall include bonds, permits, and any required insurance, project signs, pre-construction audio-video documentation, maintenance of traffic, public information officer, and any other preconstruction expense necessary for the start of the work shall also be included. This Work also consist of the general project management of the Work including, but not limited to, field supervision and office management, as well as other incidental cost for management of the Work during the duration of the Contract. This Work also includes maintenance of the field offices for the duration of the Contract. Measurement for various items covered under General Requirements, will not be made for payment, and all items shall be included in the lump sum price. This item will be paid upon each payment request made by the Contractor. The Contractor shall attach with the pay request invoices to substantiate the appropriate insurance and bonds have been obtained by the Contractor.</p> <p>Payment for Mobilization/Demobilization shall include Work consisting of the preparatory Work and operations in mobilizing for beginning Work on the Contract, including, but not limited to, movement of those personnel, equipment, supplies and incidentals to the project site, preparation of submittals, and for the establishment of temporary offices and buildings, safety equipment and first aid supplies, project signs, field surveys, sanitary and other facilities required by these specifications, and State and local laws and regulations. The Work specified in this item also consists of demobilization or the operations normally involved in ending Work on the project including, but not limited to, termination and removal of temporary utility service and field offices; demolition and removal of temporary structures and facilities; restoration of Contractor storage areas; disposal of trash and rubbish, and any other post-construction work necessary for the proper conclusion of the Work. This pay item may not exceed 5% of the Total Base Bid amount.</p> <p>Payment for Project Record Documents (Section 01720) shall be based on satisfactory progress of the Contractor to provide Project Record Documents including the certified as-built survey, in accordance with the County requirements and specifications. This pay item shall be a minimum of 1% of the Total Base Bid amount.</p> <p>Payment for Indemnification: In consideration of the Contractor's Indemnity Agreement as set out in the Contact Documents, County specifically agrees to give the Contractor \$20.00 and other good and valuable consideration, receipt of which is acknowledged upon signing of the Agreement.</p>
4	<p>Reference ID 14.120.111 Duplex Pump Station Rehabilitation (Lena Street PS #3229)</p>
	<p>a. Measurement: Measurement for this item shall be based on satisfactory rehabilitation of the existing Pump Station and adjacent sanitary sewer collection system complete and ready for continuous operation.</p>

b. Payment: Payment of the applicable Contract lump sum price as stated in the proposal will be full compensation for furnishing all labor, materials, and equipment necessary to rehabilitate the existing pump station and adjacent sanitary sewer collection system as indicated on the Drawings. Work includes but is not necessarily limited to the following: Rehabilitate and line the existing wet well, install lined wet well top slab, coat valve vault and install top slab, install pumps, motors, control panel, cables, rails, valves, fittings, pressure piping, and appurtenances as shown on the drawings. All maintenance of traffic, clearing and grubbing, fill material, grading, wastewater by-pass pumping, pumper trucks, erosion and sedimentation prevention and control. All demolition, removal, salvage and disposal of existing facilities and structures including driveway, wet well top slab, wet well mechanical and electrical contents, valve vault top slab, piping valves and fittings as noted in the Drawings including tie-ins, intercepts, conflicts, and abandonment of piping, conduits, and electrical services. All coordination, materials and equipment, tools, and labor to relocate the existing SCADA control panel, water service connection. All coordination with the electric power company, materials, equipment, tools, labor and fees to install an electrical service connection. Installation of all site and adjacent improvements noted on drawings including concrete driveway and driveway connections, concrete sidewalk, concrete paving, concrete curbing, rock fill and sodding. All materials, equipment, tools, and labor to de-scale and line (CIPP) the adjacent existing sanitary sewer collection system indicated on the Drawings. All work required to construct, test and deliver a complete operational Pump Station and rehabilitate the adjacent wastewater collection system without interruption of service.

Payment for General Requirements (Section 01001) shall include bonds, permits, and any required insurance, project signs, pre-construction audio-video documentation, maintenance of traffic, public information officer, and any other preconstruction expense necessary for the start of the work shall also be included. This Work also consist of the general project management of the Work including, but not limited to, field supervision and office management, as well as other incidental cost for management of the Work during the duration of the Contract. This Work also includes maintenance of the field offices for the duration of the Contract. Measurement for various items covered under General Requirements, will not be made for payment, and all items shall be included in the lump sum price. This item will be paid upon each payment request made by the Contractor. The Contractor shall attach with the pay request invoices to substantiate the appropriate insurance and bonds have been obtained by the Contractor.

	<p>Payment for Mobilization/Demobilization shall include Work consisting of the preparatory Work and operations in mobilizing for beginning Work on the Contract, including, but not limited to, movement of those personnel, equipment, supplies and incidentals to the project site, preparation of submittals, and for the establishment of temporary offices and buildings, safety equipment and first aid supplies, project signs, field surveys, sanitary and other facilities required by these specifications, and State and local laws and regulations. The Work specified in this item also consists of demobilization or the operations normally involved in ending Work on the project including, but not limited to, termination and removal of temporary utility service and field offices; demolition and removal of temporary structures and facilities; restoration of Contractor storage areas; disposal of trash and rubbish, and any other post-construction work necessary for the proper conclusion of the Work. This pay item may not exceed 5% of the Total Base Bid amount.</p> <p>Payment for Project Record Documents (Section 01720) shall be based on satisfactory progress of the Contractor to provide Project Record Documents including the certified as-built survey, in accordance with the County requirements and specifications. This pay item shall be a minimum of 1% of the Total Base Bid amount.</p> <p>Payment for Indemnification: In consideration of the Contractor's Indemnity Agreement as set out in the Contact Documents, County specifically agrees to give the Contractor \$20.00 and other good and valuable consideration, receipt of which is acknowledged upon signing of the Agreement.</p>
<p style="text-align: center;">5</p>	<p>Reference ID 14.120.112 Duplex Pump Station Rehabilitation (Bradford Cove PS #3890)</p>
	<p>a. Measurement: Measurement for this item shall be based on satisfactory rehabilitation of the existing Pump Station complete and ready for continuous operation.</p> <p>b. Payment: Payment of the applicable Contract lump sum price as stated in the proposal will be full compensation for furnishing all labor, materials, and equipment necessary to rehabilitate the existing pump station and provide bypass pumping as indicated on the Drawings. Work includes but is not necessarily limited to the following: Pump Station improvements and modifications including fencing and gates, masonry walls and gates, rehabilitate and line the existing wetwell, replacement of the top slab, pumps, motors, control panel, cables, rails, valves, pressure piping and appurtenances, as shown on the Drawings. All demolition, removal and disposal of existing facilities as noted in the Drawings including tie-ins, intercepts, conflicts and abandonment of piping, conduits or electrical services. All coordination, materials and equipment, tools, and labor to relocate the existing SCADA control panel, SCADA pole, water service connection, or extend an existing water service connection.</p>

All coordination with the electric power company, materials, equipment, tools, labor and fees to install an electrical service connection. Installation of all site and adjacent improvements noted on drawings including driveways and driveway connections, fencing with curb and gate, asphalt and concrete paving, rock fill and sodding. All work required to construct, complete start-up testing and deliver a complete operational Pump Station without interruption of service.

Payment for General Requirements (Section 01001) shall include bonds, permits, and required insurance, project signs, preconstruction audio-video documentation, maintenance of traffic, public information officer, and any other preconstruction expense necessary for the start of the work shall also be included. This Work also consists of the general project management of the Work including but not limited to, field supervision and office management, as well as other incidental cost for management of the Work during duration of the Contract. This work also includes maintenance of the field offices for the duration of the Contract.

Measurement for various items covered under General Requirements, will not be made for payment, and all items shall be included in the lump sum price. This item will be paid upon each payment request made by the Contractor. The Contractor shall attach with the pay request invoices to substantiate the appropriate insurance and bonds have been obtained by the Contractor.

Payment for Mobilization/Demobilization shall include Work consisting of the preparatory Work and operations in mobilizing for beginning Work on the Contract, including, but not limited to, movement of those personnel, equipment, supplied and incidentals to the project site, preparation of submittals, and for the establishment of temporary offices and buildings, safety equipment and first aid supplies, project signs, field surveys, sanitary and other facilities required by these specifications, and State and local laws and regulations. The Work specified in this item also consists of demobilization or the operations normally involved in ending Work on the project including, but not limited to termination and removal of temporary utility service and field offices; demolition and removal of temporary structures and facilities; restoration of the Contractor storage areas; disposal of trash and rubbish, and any other post-construction work necessary for the proper conclusion of the Work. This pay item may not exceed 5% of the Total Base Bid amount.

Payment for Project Record Documents (Section 01720) shall be based on satisfactory progress of the Contractor to provide Project Record Documents including the certified as-built survey, in accordance with the County requirements and specifications. This pay item shall be a minimum of 1% of the Total Base Bid amount.

Payment for Indemnification: In consideration of the Contractor's Indemnity Agreement as set out in the Contract Documents, County specifically agrees to give the Contractor \$20.00 and other good and valuable consideration, receipt

	of which is acknowledged upon signing of the Agreement.
--	---

PART 2 - PRODUCTS (NOT USED)

PART 3 - EXECUTION (NOT USED)

END OF SECTION

SECTION 01027
APPLICATIONS FOR PAYMENT

PART 1 - GENERAL

1.01 REQUIREMENT

- A. This Section specifies administrative and procedural requirements governing the Contractor's Applications for Payment.
- B. Prior to submitting a monthly payment application, the Contractor's progressive As-Built Drawings and As-Built Asset Attribute Data, Gravity Main, and Pipe Deflection Tables shall be accepted by the County.
- C. Progressive As-Built Drawings shall indicate the horizontal and vertical locations of all current constructed improvements with sufficient information and notes to easily determine if the improvements were constructed in conformance with the Contract Documents. The progressive As-Built Asset Attribute Data, Gravity Main, and Pipe Deflection Tables shall include a Surveyor's certified statement regarding the constructed improvements being within the specified accuracies or if not, indicating the variances as described in specification Section 01050 "Surveying and Field Engineering", Table 01050-1 Minimum Survey Accuracies.

1.02 FORMAT

- A. Format and Content: Use the accepted Schedule of Values.
 - 1. Arrange the Schedule of Values in a tabular form with separate columns to indicate the following for each item listed:
 - a. Generic name
 - b. Related Specification Section
 - c. Name of Subcontractor
 - d. Name of manufacturer or fabricator
 - e. Name of supplier
 - f. Dollar value
 - 2. Round amounts off to the nearest whole dollar. The total shall equal the Contract Amount.

1.03 PREPARATION OF APPLICATION

- A. Each Application for Payment shall be consistent with previous applications and payments as certified and paid for by the County.
 - 1. The initial Application for Payment: The Application for Payment at time of Substantial Completion and the final Application for Payment involve additional requirements.

- B. Payment Application Times: As stated in the General Conditions, Payment applications are to be submitted monthly on a day of the month to be established by the County at the Pre-Construction conference.
- C. Application Preparation: Complete every entry on the form, including notarization and execution by person authorized to sign legal documents on behalf of the Contractor. Incomplete applications will be returned without action.
1. Submit applications typed on forms provided by the County.
 2. Use data on Bid Form and approved Schedule of Values. Provide dollar value in each column for each line item for portion of Work performed and for stored products.
 3. List each authorized Change Order and an extension or continuation sheet, listing Change Order number and dollar amount as for an original item of work.
 4. Each item shall have an assigned dollar value for the current pay period and a cumulative value for the project to-date.
 5. Submit stored material log, partial waivers of claims and mechanic liens, and consent of surety with each application, as further explained below.
- D. Submit a stored material log with each application for payment which identifies the type, quantity and value of all stored material, and that tracks when the stored materials are installed and deducts them from stored quantity at that time. Include original invoices for all stored materials that payment is requested.
- E. Waivers of Claims and Mechanics Lien: With each Application for Payment submit waivers of claims and mechanics liens from Subcontractors or Sub-subcontractors and suppliers for the construction period covered by the previous applications.
1. Submit partial waivers on each item for the amount requested, prior to deduction for retainage, on each item.
 2. When an application shows completion of an item, submit final or full waivers.
 3. The County reserves the right to designate which entities involved in the Work must submit waivers.
 4. Submit final Application for Payment with or preceded by final waivers from every entity involved with performance of work covered by the application that could lawfully be entitled to a payment claim or lien.
 5. Waiver Forms: Submit waivers of claims and lien on forms and executed in a manner acceptable to the County.
- F. Transmittal: Submit four (4) executed copies of each Application for Payment to the County by means ensuring receipt within 24-hours. One (1) copy shall be complete, including waivers of lien and similar attachments when required.
1. Transmit each copy with a transmittal form listing attachments, and recording appropriate information related to the application in a manner acceptable to the County.
 2. The Contractor shall include a certification with each application stating that all previous payments received from the County under the Contract have been applied by the Contractor to discharge in full all obligations of the Contractor in connection with the Work by prior applications for payment, and all materials and equipment incorporated into the Work are free and clear of all liens, claims, security interest and encumbrances.

- G. Initial Application for Payment: Administrative actions and submittals that must precede or coincide with submittal of the first Application for Payment include the following:
1. List of Subcontractors
 2. List of principal suppliers and fabricators
 3. Schedule of Values
 4. Contractor's Construction Progress Schedule (accepted)
 5. List of Contractor's staff assignments
 6. Copies of building permits
 7. Copies of authorizations and licenses from governing authorities for performance of the Work
 8. Certificates of insurance and insurance policies
 9. Performance and Payment bonds (if required)
 10. Data needed to acquire County's insurance
- H. Monthly Application for Partial Payment: Administrative actions and submittals that must precede or coincide with submittal of Monthly Partial Payments include the following:
1. Relevant tests
 2. Progressive As-builts (one (1) paper copy and electronic copy)
 3. Table 01050-2 Asset Attribute Data Form Examples (one (1) paper copy and electronic copy)
 4. Table 01050-3 Pipe Deflection Table Example (one (1) paper copy and electronic copy)
 5. Table 01050-4 Gravity Main Table (one (1) paper copy and electronic copy)
 6. An electronic copy of all survey field notes
 7. Partial Release of lien
 8. Partial consent of surety
 9. Site photographs
 10. Updated Progress Schedule: submit one (1) electronic copy and five (5) copies
 11. Summary of Values
 12. Pay Request
 13. On-Site Storage
- I. Substantial Completion Application for Payment: Following issuance of the Certificate of Substantial Completion, submit an Application for Payment. This application shall reflect any Certificates of Partial Substantial Completion issued previously for County occupancy of designated portions of the Work.
1. Administrative actions and submittals that shall precede or coincide with this application include:
 - a. Occupancy permits and similar approvals
 - b. Warranties (guarantees) and maintenance agreements
 - c. Test/adjust/balance records
 - d. Maintenance instructions
 - e. Meter readings
 - f. Start-up performance reports
 - g. Change-over information related to the County's occupancy, use, operation and maintenance

- h. Final Cleaning
 - i. Application for reduction of retainage and consent of surety
 - j. Advice on shifting insurance coverage
 - k. List of incomplete Work, recognized as exceptions to County's Certificate of Substantial Completion
- J. Final Completion Application for Payment: Administrative actions and submittals which must precede or coincide with submittal of the final payment Application for Payment include the following:
- 1. Prior to submitting a request for final payment or the County issuing a Certificate of Completion for the Work, the Contractor shall submit the final Record Documents to the County for approval. Retainage funds will be withheld at the County's discretion based on the quality and accuracy of the final Record Documents.
 - 2. Completion of project close-out requirements
 - 3. Completion of items specified for completion after Substantial Completion
 - 4. Assurance that unsettled claims are settled
 - 5. Assurance that work not complete and accepted is now completed
 - 6. Transmittal of required project construction records to the County
 - 7. Proof those taxes, fees and similar obligations have been paid
 - 8. Removal of temporary facilities and services has been completed.
 - 9. Removal of surplus materials, rubbish and similar elements
 - 10. Change of door locks to County's access
 - 11. Execute certification by signature of authorized officer.
 - 12. Prepare Application for Final Payment as required in General Conditions.

1.04 SUBMITTAL PROCEDURES

- A. Submit four (4) copies of each Application for Payment at time stipulated in Agreement.
- B. Submit under transmittal letter.

1.05 SUBSTANTIATING DATA

- A. When the County requires substantiating information, submit data justifying line item amounts in question.
- B. Provide one (1) copy of data with cover letter for each copy of submittal. Show Application number and date, and line item by number and description.

PART 2 - PRODUCTS (NOT USED)

PART 3 - EXECUTION (NOT USED)

END OF SECTION

SECTION 01050
SURVEYING AND FIELD ENGINEERING

PART 1 - GENERAL

1.01 DESCRIPTION

- A. Professional Surveyor: Provide professional surveying and mapping work required for the execution of the contract, including verification of existing survey data, construction layout, and production of the As-Built Drawings. This Work shall be performed by a Surveyor that is licensed by the State of Florida as a Professional Surveyor and Mapper pursuant to Chapter 472, F.S.
- B. Professional Engineer: The Contractor shall provide the services of a Registered Professional Engineer currently licensed in the State of Florida for the following specific services as applicable to the Work.

1.02 REQUIREMENTS

A. Survey Services

- 1. The Contractor shall retain the services of a registered Surveyor and Mapper licensed in the State of Florida to provide professional surveying and mapping services, and maintain both a control survey and an as-built survey during construction. The Surveyor will identify control points (monuments and benchmarks noted on the Drawings). The construction layout survey shall be established from the control points shown on the Construction Drawings and confirmed. The method of field staking for the construction of the Work shall be at the option of Contractor. The accuracy of any method of staking shall be the responsibility of Surveyor. All staking shall be done to provide for easy verification of the Work by the County. The Contractor shall provide all surveys necessary for the construction of the Work.

B. Engineering Services

- 1. The Engineer shall be responsible for duties during Construction to include, but not limited to:
 - a. Inspections, testing, witnessing requiring a licensed Professional Engineer.
 - b. Design of temporary shoring, bridging, scaffolding or other temporary construction, formwork and protection of existing structures.
 - c. Other requirements as specified herein.
- 2. Engineering related designs, tests and inspections shall be signed by the licensed Professional Engineer as required by the County.

1.03 QUALIFICATIONS OF THE SURVEYOR

- A. The Surveyor, who is proposed by the Contractor to provide services for the Project, is subject to the approval of the County. Prior to any services being performed, the Contractor shall submit the name and address of any proposed Surveyor and a written acknowledgement from the Surveyor stating that he has the hardware, software and adequate scope of services in his agreement with the Contractor to fully comply with the requirements of this specification. These submittals shall be provided to the County prior to Notice to Proceed. It is recommended that the Surveyor attend the Pre-Construction meeting. Any Surveyor, who has not previously performed work for the County shall attend the Pre-Construction meeting.

1.04 SUBMITTALS

- A. Provide qualifications of the Surveyor or Engineer.
 - 1. A Florida Registered Professional Engineer or Registered Surveyor and Mapper, who is proposed by the Contractor to provide services for the Work, shall be acceptable to the County prior to field services being performed.
 - 2. A Professional Engineer shall be of the discipline required for the specific service for the Work.
 - 3. Submit name, address and telephone number of the Surveyor and/or Engineer, as appropriate to the County for acceptance before starting survey or engineering work.
- B. On request, submit documentation verifying accuracy of survey work.
- C. Surveyor shall certify all elevations and locations included in Table 01050- 2, 3, and 4.

PART 2 - PRODUCTS

2.01 SURVEY DOCUMENTS

- A. Survey documents shall comply with the Minimum Technical Standards of Chapter 5J-17 of the Florida Administrative Code (FAC) and Table 01050-1 Minimum Survey Accuracies, whichever are more stringent. All coordinates shall be geographically registered in the Florida State Plan Coordinate System using the contract Drawings control points for horizontal and vertical controls.
- B. The Surveyor shall not copyright any of their Work related to this project.

**Table 01050-1
Minimum Survey Accuracies**

Asset	Horizontal Accuracy (feet)	Elevation Accuracy (feet)	Location: Horizontal Center and Vertical Top, unless otherwise specified
Bench Marks	0.01	0.01	Point
Baseline Control Locational Accuracy	0.01	N/A	Point
Tract and Easement Corners	*	N/A	Survey Monuments
Mains at 100-foot maximum intervals	0.1	0.1	Pipe, Pipe at Valves, Pipe at Bore & Jack Casing
PVC pipe >16-inch at every pipe joint	0.1	0.1	Pipe, Pipe at Valves, Pipe at Bore & Jack Casing
Fittings, Sleeve, Tapping Saddle, and end of the pipe if Plugged or Capped.	0.1	0.1	Fitting
Restrained Pipe	0.1	N/A	Restrained Joint Limits
Connections	0.1	0.1	Pipe
Bore & Jack Casing	0.1	0.1	Top of Casing at the Casing Limits
Directional Drill	0.1	0.1	10-foot intervals during the directional drill operation
Hydrants	0.1	N/A	Operating Nut of Hydrant
Valves	0.1	0.1	Operating Nut
Air Release, Blow off, and Backflow Valves	0.1	N/A	Valve Enclosure
Master Meters, Deduct Meters & Wastewater Meters	0.1	N/A	Register
Meter Box	0.1	N/A	Meter Box
Clean out	0.1	N/A	Clean out
Manhole Rim	0.1	0.1	Manhole
Manhole Inverts	N/A	0.01	Pipe Inverts
Pump Station (Public & Private)	0.1	0.01	Wetwell and Pipe Inverts
Production Well or Monitoring Well	0.1	0.1	Well
Grease Interceptor	0.1	0.1	
Oil / Water Separators	0.1	0.1	
Demolished Pipe (abandoned in place or removed)	0.1	0.1	Limits of Abandoned or Removed Pipe
Existing Utilities water, wastewater, reclaimed water, and appurtenant structures **	0.1	0.1	Pipe or Structure
* Shall conform to the requirements of the "Chapter 5J-17, 'Minimum Technical Standards', FAC", certified by a SURVEYOR.			
** Existing utilities including but not limited to water, wastewater, reclaimed water, stormwater, fiber optic cable, electric, gas and structures within the limits of construction.			

**TABLE 01050-2
Asset Attribute Data Form Examples**

Hydrants Worksheet

Microsoft Excel - Example ContractorUploadSheet 2010-0326.xls								
	A	C	D	E	F	G	H	I
1	ID Number	Plan Sheet #	Easting	Northing	Elevation	Manufacturer	Model #	Comments
2	FH-1	C-7	518456.40	1483743.63	49.53	Brand B	XJ7-B	
3	FH-2	C-9	518477.68	1483758.95	54.23	Brand B	XJ7-B	

Valves Worksheet

Microsoft Excel - Example ContractorUploadSheet 2010-0326.xls									
	A	C	D	E	F	G	H	I	J
1	ID Number	Plan Sheet #	Easting	Northing	Elevation	Valve Type	Main Type	Valve Size	Valve Manufacture
2	ARV-1	C301	518060.09	1483231.33	81.72	ARV - Combination	Water Main	2	Brand H
3	ARV-1	C303	518083.55	1483280.50	81.15	ARV - Vacuum	Force Main	4	Brand G
4	BFP-1	C303	518086.00	1483282.88	78.21	Backflow Preventer	Reclaimed Water Main	8	Brand F
5	BO-9	C405	518088.83	1483289.43	78.20	Blowoff	Water Main	2	Brand E
6	BFV-1	C405	518088.11	1483295.00	81.95	Butterfly	Water Main	30	Brand D
7	GV-3	C405	518132.54	1483372.75	81.23	Gate	Water Main	16	Brand C
8	LS-W1	C405	576779.36	1539706.97	64.30	Line Stop	Water Main	16	Brand B
9	PV-22	C405	576880.60	1539718.32	64.52	Plug	Force Main	12	Brand A

Microsoft Excel - Example ContractorUploadSheet 2010-0326.xls								
	J	K	L	M	N	O	P	Q
1	Valve Manufacturer	Valve Model #	# of Turns to Close	Gear Actuator	Gear Ratio	Side Actuator	uator Manufact	Comments
2	Brand H	100XT						
3	Brand G	1000						
4	Brand F	2000 fgs						
5	Brand E	14 turbo						
6	Brand D	230 xls	200	Yes	3 to 1	Yes	Brand C	
7	Brand C	2225846	300	Yes	3 to 1	NO		
8	Brand B	7n6r44						
9	Brand A	Z100	200	Yes	3 to 1	Yes	Brand A	

Manhole Worksheet

Microsoft Excel - Example ContractorUploadSheet 2010-0326.xls														
	A	C	D	E	F	G	H	I	J	K	L	M	N	O
1	ID Number	Plan Sheet #	Easting	Northing	Rim Elevation	Invert Elev II	Invert Elev IE	Invert Elev E	Invert Elev SE	Invert Elev S	Invert Elev SW	Invert Elev W	Invert Elev IW	Manufacturer
2	MH-1	C-20	517999.15	1483092.24	82.96	76.96		76.96		76.91				Brand X
3	MH-2	C-20	517999.15	1483492.24	83.54	75.63				75.58				Brand X

Meter Worksheet

Microsoft Excel - Example ContractorUploadSheet 2010-0326.xls							
	A	C	D	E	F	G	H
1	ID Number	Plan Sheet #	Easting	Northing	Elevation	Main Type	Comments
2	MM-1	C-6	576533.64	1539520.08	58.01	Water Main	
3	RWMM-1	C-6	576937.42	1539598.78	64.84	Reclaimed Water Main	

Fitting Worksheet

Microsoft Excel - Example ContractorUploadSheet 2010-0326.xls								
	A	C	D	E	F	G	H	I
1	ID Number	Plan Sheet #	Easting	Northing	Elevation	Main Type	Fitting Type	Comments
2	FM-1	C-3	572399.28	1539339.13	46.27	Force Main	Bend 11 1/4°	
3	FM-2	C-3	574840.74	1539856.91	51.73	Force Main	Bend 22-1/2°	
4	FM-3	C-3	574844.01	1539856.71	52.48	Force Main	Bend 45°	
5	FM-4	C-3	574845.72	1539856.61	52.33	Water Main	Bend 90°	
6	FM-5	C-3	574845.85	1539858.77	51.98	Water Main	Cap	
7	RW-1	C-4	574884.06	1539849.64	51.75	Reclaimed Water Main	Cross	
8	RW-2	C-4	574887.22	1539849.56	48.98	Reclaimed Water Main	Reducer	
9	RW-3	C-4	574904.30	1539849.10	49.39	Reclaimed Water Main	Plug	
10	RW-4	C-4	574907.42	1539849.01	52.32	Reclaimed Water Main	Sleeve	
11	WM-1	C-5	574938.65	1539848.16	54.42	Water Main	Tapping Saddle	
12	WM-2	C-5	572532.38	1539337.10	45.27	Water Main	Tee	
13	WM-3	C-5	572631.00	1539338.00	44.13	Water Main	Wye	
14	WM-4	C-5	572731.00	1539334.00	43.77	Water Main	Tapping Sleeve	

Cleanout Worksheet

Microsoft Excel - Example ContractorUploadSheet 2010-0326.xls						
	A	C	D	E	F	G
1	ID Number	Plan Sheet #	Easting	Northing	Elevation	Comments
2	CO-1	C-6	576533.64	1539520.08	58.01	
3	CO-2	C-6	576937.42	1539598.78	64.84	

Pipes Worksheet

Microsoft Excel - Example ContractorUploadSheet 2010-0326.xls												
	A	C	D	E	F	G	H	I	J	K	L	M
1	ID Number	Plan Sheet #	Easting	Northing	Elevation	Main Type	Type of Shot	Instruction Method	Material	Pressure Class	Manufacturer	Color
2	CSNG-1	C-4	517827.57	1482195.46	78.83	Force Main	Bore & Jack (Casing)		PVC	DR18	Brand A	
3	CSNG-2	C-4	517848.20	1482195.31	78.38	Force Main	Bore & Jack (Casing)		PVC	DR18	Brand A	
4	RW-1	C-7	517731.98	1482237.24	80.42	Reclaimed Water Main	Restraint Joint Limit	Open Cut	DIP	Class 250	Brand B	
5	RW-2	C-7	517732.848	1482338.1	80.943	Reclaimed Water Main	Restraint Joint Limit	Open Cut	DIP	Class 250	Brand B	
6	WM-1	C-9	573309.068	1539372.9	56.10	Water main	Shot on Pipe	Open Cut	PVC	DR18	Brand C	
7	WM-2	C-9	573308.752	1539375	54.66	Water main	Shot on Pipe	Open Cut	PVC	DR18	Brand C	
8	FMDD-1	C-4	504345.94	1488969.2	114.14	Force Main	Shot on Pipe	Directional Drill	HDPE	DR17	Brand X	
9	FMDD-2	C-4	504360.86	1488970.5	112.74	Force Main	Shot on Pipe	Directional Drill	HDPE	DR17	Brand X	
10	FMDD-3	C-4	504377.19	1488971.2	106.14	Force Main	Shot on Pipe	Directional Drill	HDPE	DR17	Brand X	
11	FM-9	C-4	504480.47	1488982.9	105.24	Force Main	Shot on Pipe	Open Cut	PVC	DR18	Brand C	

Well Worksheet

Microsoft Excel - Example ContractorUploadSheet 2010-0326.xls						
	A	C	D	E	F	G
1	ID Number	Plan Sheet #	Easting	Northing	Elevation	Comments
2	PS-1	C-40	517914.346	1482906.562	83.912	

Easements Worksheet

	A	C	D	E	F	G	H
1	ID Number	Plan Sheet #	Easting	Northing	Elevation	Boundary Corner Type	Comments
2	Corner-1	C-8	463484.59	1511029.72		Pump Station Tract	N.W. CORNER
3	Corner-2	C-8	463523.24	1511040.01		Pump Station Tract	N.E. CORNER
4	Corner-3	C-8	463480.45	1511015.23		Pump Station Tract	S.W. CORNER
5	Corner-4	C-8	463526.97	1511025.49		Pump Station Tract	S.E. CORNER
6						Easement	
7						Property	

Existing OC Utility Crossing

	A	C	D	E	F	G	H	I
1	ID Number	Plan Sheet #	Easting	Northing	Existing Pipe Elevation	Proposed Crossing Elevation	Existing Main Type	Comments
3	Conf-1	C-750	463464.47	1511013.75	100.54	104.88	Water main	
4	Conf-2	C-750	463163.91	1510693.49	98.32	103.57	Storm Main	

Grease Interceptor

	A	C	D	E	F	G	H
1	ID Number	Plan Sheet #	Easting	Northing	Elevation	Volume (Gallons)	Comments
2	GI-1	C-400	508387.3	1487203.18	89.70	1000.00	

For ease of calculating pipe deflections in Table 01050-3, begin by providing a unique asset ID (top of pipe shots and fittings) for each utility and type, numbered sequentially along the pipe run (including changes in direction) from start to finish of the pipe in the Table 01050-2. Then branches and services of the same utility type can be numbered. It is recommended that each utility (water, wastewater or reclaimed water) numbering format be distinguishable from the other. This will allow organization and convenient sorting after the individual asset table worksheet tabs are combined in the spreadsheet program prior to copying and pasting to the deflection table spreadsheet.

**TABLE 01050-3
PIPE DEFLECTION TABLE EXAMPLE**

Project Contractor: Progress Mtg Date: Contract # Dwg Sheet # Utility Type Pipe Manufacturer Pipe size & material PVC Manufacturer Deflection County Allowable Deflection 75% Allowable Angle of Offset Allowable Radius of Curvature Laying Length of Pipe	FM National Pipe 16" PVC C905 6 inches 4.5 inches 1.5 degrees 764 feet 20 feet	
--	---	--

ID	Size and Type	Northing	Easting	Elev.	Calculations Including Elevation (XYZ)							
					Distance between points AB	Distance between points BC	Distance between points AC	Total Deflection Ø°	Radius of Curve ^A	Average Offset Angle ^{***}	Average Offset ^{****}	
					Length AB ft	Length BC ft	Length AC ft	XYZ (w elevation) degrees	XYZ (w elevation) ft	per laying length degrees	per laying length inches	
14041	16" FM	1505131.50	468948.53	107.68	-	-	-	-	-	-	-	-
7000	16" FM	1505059.60	468932.08	108.15	73.76	38.93	112.66	5.48	1,178.35	0.97	4.07	
2128	16" FM	1505022.11	468921.60	108.55	38.93	39.61	78.54	2.29	1,961.65	0.58	2.45	
2127	16" FM	1504983.85	468911.35	108.29	39.61	38.35	77.96	1.78	2,505.50	0.46	1.92	
2126	16" FM	1504946.67	468901.96	107.81	38.35	39.13	77.42	8.79	505.16	2.27	9.51	
2125	16" FM	1504908.11	468895.31	107.48								

Data that has been inputted
 Values in yellow are over spec

*Uses law of cosines to determine angle ABC and Ø.
 $\text{angle } ABC = \arccos((AB^2 + BC^2 - AC^2) / (2 * AB * BC))$
 $180 - \text{angle } ABC = \text{angle } \phi$
 Calculate the total deflection Ø.
 to the outer point (A or C) is equal in angle to the approach from the next point along the

** Uses law of sines, using the chord length AC and radius R.
 $\text{Since } \sin((\phi/2) * (\pi/180)) = (\text{Chord}/2) / R \text{ and length } AC = \text{Chord}$
 $R = AC / (2 * \sin(\phi * \pi / 360))$
 This calculation assumes an average radius over the bend between three points.

*** Adds the lengths of AB + BC / 20ft to get an approximate number of bends over the span.
 This value is divided by the total deflection angle to calculate the average bend angle of
 This assumes that the bend angle consistent across the entire length.

**** Uses average offset angle and laying length of pipe.

PART 3 - EXECUTION

3.01 SURVEY FIELD WORK

- A. Locate, reference, and preserve existing horizontal and vertical control points and property corners shown on the Drawings prior to starting any construction work. If the Surveyor performing the Work discovers any discrepancies that will affect the Project, the Contractor must immediately report these findings to the County. All survey work shall meet the requirements as defined in Florida Administrative Code 5J-17. Reference and preserve all survey points during Construction. If survey points are disturbed, it is the responsibility of the Contractor's Surveyor to reset the points at the Contractor's expense. Copies of the Surveyor's field notes and/or electronic files for point replacement shall be provided to the County.
 1. The Surveyor shall locate all improvements for the project As-Built Asset Attribute Data using State Plane Coordinates as the horizontal datum and the benchmark referenced on the Drawings as the vertical datum. The County will provide electronic files of the Drawings to be used by the Surveyor in complying with these specifications.
 2. The construction layout shall be established from the reference points shown or listed on the Drawings. The accuracy of any method of staking shall be the responsibility of the Contractor. All construction layout staking shall be done such as to provide for easy verification of the Work by the County.
- B. Only a Surveyor licensed in the State of Florida shall be employed for this Work. All control points shall be protected by the Contractor from disturbance. If the monuments are disturbed, any Work that is governed by these monuments shall be held in abeyance until the monuments are reestablished by the Contractor and approved by the County. The accuracy of all the Contractor's stakes, alignments and grades is the responsibility of the Contractor. However, the County has the discretionary right to check the Contractor's stakes, alignments, and grades at any time.
- C. Use survey control points to layout such work tasks including but not limited to:
 1. Clearing, grubbing, work limits, right-of-way lines and easements
 2. Locations for pipelines and all associated structures and appurtenances
- D. The Surveyor shall reference and replace any project control points, boundary corners, benchmarks, section corners, and right-of-way monuments that may be lost or destroyed, at no additional cost to the County. Establish replacement points based on the original survey control. Copies of all reference field notes and/or electronic files for point replacement shall be submitted to the County.

3.02 SURVEYING

- A. Locate and protect existing horizontal and vertical control points shown on the construction Drawings prior to starting any work. If the Surveyor performing the Work finds differences that will effect the Work, the Contractor must immediately report the findings to the County. Establish control points, lines and levels by instrumentation and similar appropriate means. The location of these points should minimize the number of sightings necessary to control the Work and the likelihood of the points being disturbed. Preserve and reference all permanent reference points during Construction. If permanent reference points are disturbed, it is the responsibility of the Contractor's Surveyor to reset the points at the Contractor's expense. Copies of the Surveyor's field notes shall be provided to the County.
 - 1. Record locations, with horizontal and vertical data, on project As-Built survey.
 - 2. Make no changes or relocations without prior written notice to the County or without receipt of written approval from the County.
 - 3. Report to the County when any control point is lost or destroyed or requires relocation because of necessary changes in grades or locations.
- B. Cover for water, reclaimed water and force mains shall vary to provide long uniform gradient or slope to pipe to minimize air pockets and air release valves. The locations shown on the Drawings for air and vacuum release valve assemblies are approximate and the Contractor shall field adjust these locations to locate these valves at the highest point in the pipeline installed.
- C. To insure a uniform gradient for gravity pipe and pressure pipe, all lines shall be installed using the following control techniques as a minimum:
 - 1. Gravity lines: Continuous control, using laser beam technology,
 - 2. Pressure lines: Control stakes set at 50 ft. intervals using Surveyor's level instrument.

3.03 SURVEY DOCUMENTS

- A. The Tables 01050-2 Asset Attribute Data, 01050-3 Pipe Deflection Table, and 01050-4 Gravity Main Table shall be signed, sealed and dated by the Surveyor with each pay request as specified in Section 01027 "Application for Payment" and the requirements of Section 01720 "Project Record Documents."

END OF SECTION

THIS PAGE LEFT BLANK INTENTIONALLY

SECTION 01065
PERMITS AND FEES

PART 1 - GENERAL

1.01 REQUIREMENTS

A. General

1. Upon Notice of Award, obtain and pay for all appropriate and applicable permits and licenses as provided for in the General Conditions, except as otherwise provided herein.
2. Schedule all inspections and obtain all written approvals of the agencies required by the permits and licenses.
3. Strictly adhere to the specific requirements of the governmental unit(s) or agency(cies) having jurisdiction over the Work. Whenever there is a difference in the requirements of a jurisdictional body and the Contract Documents, the more stringent shall apply.
4. A copy of the permits obtained by the County are furnished in Appendix C "Permits Obtained by County" of these specifications.
5. Unless otherwise specified, the cost of work specified in the various sections of Division 1, will not be paid for separately but the cost therefore shall be considered incidental to and included in the bid prices of the various Contract items.

B. Building Permit (Orange County)

1. The County will pay the general building permit fee and any related impact fees or assessments to be paid to Orange County for the issuance of that permit only.
2. The Contractor shall pay all fees associated with obtaining Orange County trade permits and any and all inspection fees for the Orange County Building Department providing inspections for this project. The Contractor shall apply for and obtain the building permits from Orange County and schedule and obtain final approval from the building inspectors.
3. Information on Orange County Building Department fees is included in the Instructions to Bidders in Division 0.
4. The Contractor shall be responsible for scheduling all permit inspections and obtaining inspection approval from Orange County, as required by the building and sub-discipline construction permits.

C. Construction Dewatering Permit

The Contractor shall apply and pay for all fees associated with obtaining Florida Department of Environmental Protection District Office construction dewatering permits, if required. The Contractor shall provide all materials and equipment to comply with the permit requirements at no additional cost to the County.

PART 2 - PRODUCTS (NOT USED)

PART 3 - EXECUTION (NOT USED)

END OF SECTION

SECTION 01070
ABBREVIATIONS AND SYMBOLS

PART 1 - GENERAL

1.01 REQUIREMENTS INCLUDED

- A. Reference to the following standards of any technical society, organization or body shall be construed to mean the latest standard, code or specification or tentative specification adopted and published at the date of advertisement for bids, even though reference has been made to an earlier standard. Such reference is hereby made a part of the Contract the same as if herein repeated in full and in the event of any conflict between any of these specifications, standard codes or tentative specifications and the Contract Documents, the most stringent shall govern.

AA	Aluminum Association
AASHTO	American Association of State Highway and Transportation Officials
ABPA	Acoustical and Board Products Association
ACI	American Concrete Institute
AFBMA	Anti-Friction Bearing Manufacturer's Association
AGA	American Gas Association
AGMA	American Gear Manufacturers Association
AI	The Asphalt Institute
AIA	American Institute of Architects
AIEE	American Institute of Electrical Engineers
AIMA	Acoustical and Insulating Materials Association
AISC	American Institute of Steel Construction
AISI	American Iron and Steel Institute
AMCA	American Moving and Conditioning Association
ANSI	American National Standards Institute
API	American Petroleum Institute
APWA	American Public Works Association
AREA	American Railway Engineering Association
ASA	American Standards Association (now ANSI)
ASCE	American Society of Civil Engineers
ASHRAE	American Society of Heating, Refrigerating, and Air Conditioning Engineers
ASME	American Society of Mechanical Engineers
ASSCBC	American Standard Safety Code for Building Construction
ASTM	American Society for Testing and Materials
AWPA	American Wood Preservers Association
AWBP	American Wood Preservers Board
AWS	American Welding Society
AWWA	American Water Works Association

CRSI	Concrete Reinforcing Steel Institute
CS	Commercial Standard
DOT Spec	Standard Specification for Road and Bridge Construction –
FDOT	Florida Department of Transportation
FAC	Florida Administrative Code
FS	Federal Standard
IEEE	Institute of Electrical and Electronic Engineers
IPCEA	Insulated Power Cable Engineers Association
NACE	National Association of Corrosion Engineers
NASSCO	National Association of Sewer Service Companies
NBFU	National Board of Fire Underwriters
NBS	National Bureau of Standards
NEC	National Electrical Code
NECA	National Electrical Contractor's Association
NEMA	National Electrical Manufacturers Association
NFPA	National Fire Protection Association
NPT	National Pipe Threads
NSF	National Science Foundation
OSHA	U.S. Department of Labor, Occupational Safety and Health Administration
PCA	Portland Cement Association
PCI	Prestressed Concrete Institute
PS	United States Products Standards
SAE	Society of Automotive Engineers
SDI	Steel Decks Institute
SJI	Steel Joists Institute
SMACNA	Sheet Metal and Air Conditioning Contractors National Association
SSPC	Structural Steel Painting Council
UL	Underwriter's Laboratories, Inc.
USASI	United States of American Standards Institute (Now ANSI)

B. UNITS OF MEASUREMENT

CU FT	cubic feet
CU IN	cubic inch(es)
CY	cubic yard(s)
DegC	degree(s) Centigrade
DegF	degree(s) Fahrenheit
F	Fahrenheit
FT	feet, foot
G	gram(s)
GA	gage
GAL	gallon(s)
GPH	gallon(s) per hour
GPM	gallon(s) per minute

GPS	gallon(s) per second
HR	hour(s)
IN	inch(es)
IPS	iron pipe size
KG	kilogram(s)
L	liter(s)
LB	pound(s)
LBF-IN	pound (force) inch
LF	linear foot, linear feet
MIN. min.	minute(s), minimum
ml	milliliter
MO	month(s)
OZ	ounce(s)
QT	quart
RH	relative humidity
SF	square foot, square feet
SQ IN	square inch(es)
YD	yard(s)
YR	year(s)

C. TERMINOLOGY

@	at
AB	anchor bolt
ADJ	adjust, adjustable
ADMIN	administration
AFG	above finished grade
AGGR	aggregate
AL	aluminum
ALT	alternate
APPX	appendix
APX	approximate
ART	article
ASPH	asphalt
ASSY	assembly
AUTO	automatic
AUX	auxiliary
AVE	avenue
AVG	average
AWG	American Wire Gauge
BAR	barrier
BCCMP	bituminous coated corrugated metal pipe
BL	base line
BLDG	building
BLKG	blocking
BM	beam

C to C	center to center
CCB	concrete block, masonry
CEM	cement
CIP	cast iron pipe, cast in place
CJ	construction joint
CL	center line, clearance
CM	Construction Manager
CMP	corrugated metal pipe
CO	cleanout
CONC	concrete
CONN	connection
CONST	construction
CONT	continuous
CONTR	contractor
CU, COP	copper
ORR	corridor
CRIT	critical
CTD	coated
CTR	center
CULV	culvert
d	delta
DBL	double
DEM	demolition, demolish
DEPT	department
DET	detail
DIA, D	diameter
DIAG	diagonal
DIM	dimension
DWG	drawing
FEM	female
FUT	future
FV	field verify
FM	force main
FH, HYD	fire hydrant
ID	inside diameter
MAS	masonry
MATL	material
MAX	maximum
MFD	manufactured
MFG	manufacturing
MFR	manufacturer
MH	manhole, metal hallide
MIN	minimum
MISC	miscellaneous
MTL	material

NAT	natural
NATL	national
NOM	nominal
NTS	not to scale
OD	outside diameter
PP	power pole
R	radius
Rd	road
REIN	reinforce
REL A	relief air
REQD	required
REV	revision
RR	railroad
R/W	right-of-way
RWM	reclaimed water main
RY	railway
SAN	sanitary
SCH	schedule
SECT	section
SLV	sleeve
SQ	square
SST	stainless steel
ST	street
STA	station
STD	standard
SURF	surface
SUSP	suspend(ed)
SYM	Symbol, symmetrical
SYS	system
TEMP	Temperature, temporary
TYP	typical
UTIL	utility
W	West
WLD	welded
WM	water main
W/O	without
WT	weight
YD	yard
YR	year
Y W	wye

END OF SECTION

THIS PAGE LEFT BLANK INTENTIONALLY

SECTION 01091
REFERENCE SPECIFICATIONS

PART 1 - GENERAL

1.01 GENERAL

- A. Applicable Publications: Whenever in these Specifications references are made to published specifications, codes, standards, or other requirements, it shall be understood that wherever no date is specified, only the latest specifications, standards, or requirements of the respective issuing agencies which have been published as of the date that the Work is advertised for bids, shall apply; except to the extent that said standards or requirements may be in conflict with applicable laws, ordinances, or governing codes. No requirements set forth herein or shown on the Drawings shall be waived because of any provision of or omission from said standards or requirements.

- B. Assignment of Specialists: In certain instances, specification test requires (or implies) that specific work is to be assigned to specialist or expert entities who must be engaged for the performance of the Work. Such assignments shall be recognized as special requirements over which the Contractor has no choice or option. These requirements shall not be interpreted so as to conflict with the enforcement of building codes and similar regulations governing the Work. They are not intended to interfere with local union jurisdiction settlements and similar conventions. Such assignments are intended to establish which party or entity involved in a specific unit of Work is recognized as "expert" for the indicated construction processes or operations. Nevertheless, the final responsibility for fulfillment of the entire set of Contract requirements remains with the Contractor.

1.02 REFERENCE SPECIFICATIONS, CODES, AND STANDARDS

- A. Without limiting the generality of other requirements of the Specifications, all Work specified herein shall conform to or exceed the requirements of such referenced documents which are not in conflict with the requirements of these Specifications or applicable codes.

- B. References herein to "Building Code" shall mean the Florida Building Code. The latest edition of the code shall apply to the Work herein, including all addenda, modifications, amendments, or other lawful changes thereto.

- C. In case of conflict between codes, reference standards, Drawings, and the other Contract Documents, the most stringent requirements shall govern. All conflicts shall be brought to the attention of the Engineer for clarification and directions prior to ordering or providing any materials or labor. The Contractor shall bid the most stringent requirements.

D. Applicable Standard Specifications: The Contractor shall construct the Work specified herein in accordance with the requirements of the Contract Documents and the referenced portions of those referenced codes, standards, and specifications listed.

PART 2 - PRODUCTS (NOT USED)

PART 3 - EXECUTION (NOT USED)

END OF SECTION

SECTION 01200
PROJECT MEETINGS

PART 1 - GENERAL

1.01 REQUIREMENTS INCLUDED

- A. Contractor participation in pre-construction conferences, progress meetings and specially called meetings.

1.02 MEETINGS CALLED BY THE COUNTY

- A. The County will schedule and administer a pre-construction conference, periodic progress meetings and specific topic meetings throughout the progress of the Work. The County will:
 - 1. Prepare and distribute a notification of the meeting to required attendees.
 - 2. Establish, prepare and distribute an agenda with the notification.
 - 3. Make physical arrangements for the meetings.
 - 4. Preside at meetings.
 - 5. Prepare and distribute minutes of meetings including significant proceedings and decisions, within 15 working days after each meeting. Minutes will be forwarded to all participants and to parties affected by decisions made at the meeting.
- B. Representatives of the Contractor, Subcontractors and suppliers attending meetings shall be qualified and authorized to act on behalf of the entity each represents.
- C. The meeting location will generally be a central site, convenient for all parties, designated by the County.

1.03 PRE-CONSTRUCTION CONFERENCE

- A. Attendance:
 - 1. County
 - 2. Contractor and superintendent
 - 3. Subcontractors as appropriate to the agenda
 - 4. Representatives of suppliers and manufacturers as appropriate to the agenda
 - 5. County MBE/WBE representative
 - 6. Other agency representatives (FDEP, EPA, City, etc.)
 - 7. Others as requested by the County or Contractor

B. Suggested Agenda:

1. Distribution and discussion of:
 - a. List of major Subcontractors and suppliers
 - b. Construction schedules
 - c. Contact information
2. Organizational arrangement of Contractor's forces and personnel, and those of Subcontractors, material and equipment suppliers, and the County
3. Critical work sequencing
4. Major equipment deliveries
5. Project coordination
 - a. Designation of responsible personnel
 - b. Channels and procedures for communication
6. Procedures and processing of:
 - a. Field decisions
 - b. Proposal requests
 - c. Submittals
 - d. Change orders
 - e. Applications for payment/Schedule of Values
 - f. Contractor quality control
 - g. Submittal of Shop Drawings, project data and samples
7. Adequacy of distribution of Contract Documents
8. Procedures for maintaining as built and record documents
9. Use of premises:
 - a. Office, work and storage areas
 - b. County's requirements
 - c. Housekeeping
10. Temporary construction facilities
11. Temporary utilities
12. Safety and first aid procedures
13. Rules and regulations
14. Security procedures
15. Place, date and time for regular progress meetings
16. Completion time for Contract and liquidated damages

1.04 PROGRESS MEETINGS

- A. The County will schedule progress meetings every month and as required by progress of the Work with the first meeting (one) 1-month after the pre-construction meeting. The Contractor will prepare and distribute the meeting minutes within 7 calendar days.
- B. Attendance:
 1. County
 2. Contractor
 3. Subcontractors as appropriate to the agenda
 4. Suppliers as appropriate to the agenda
 5. Others as appropriate

- C. The Contractor's representative is to attend the project meetings and have the authority to act on behalf of the entity represented on field related matters. Contractor's representative is to study previous meeting minutes and current agenda items, in order to be prepared to discuss pertinent topics and provide specific information including but not limited to:
 - 1. Status of submittals and actions necessary to expedite them
 - 2. Status of activities behind schedule and actions necessary to regain the approved schedule
 - 3. Status of materials and equipment deliveries and action necessary to expedite materials and equipment and maintain the approved schedule
 - 4. Status of open RFI's and actions necessary to address them

- D. To the maximum extent practicable, the Contractor is to assign the same personnel to represent the Contractor at Progress Meetings throughout the progress of the Work.

- E. The Contractor is to provide a current Shop Drawing submittal log at each progress meeting.

- F. The Contractor is to provide copies of the updated Progress Schedule at each project meeting in accordance with the General Conditions.

- G. Suggested Agenda:
 - 1. Review and approve minutes from previous meeting
 - 2. Review of Work progress since previous meeting to include current As-Builts
 - 3. Contractor's/Subcontractor's workforce and equipment
 - 4. Progressive As-Built Drawings
 - 5. Surveyor's submittals
 - a. As-Built Asset Attribute Data Table (see Table 01050-2)
 - b. Pipe Deflection Table (see Table 01050-3)
 - c. Gravity Main Table (see Table 01050-4)
 - 6. Field observations, problems and conflicts
 - 7. Construction progress and problems which impede construction schedule
 - 8. Shop Drawing submittal status
 - 9. Requests for Information (RFI) status
 - 10. Change order status
 - 11. Review of off site fabrication and delivery schedules
 - 12. Corrective measures and procedures to regain approved schedule
 - 13. Revisions to construction schedule
 - 14. Job progress and schedule for succeeding work period
 - 15. Coordination of schedules
 - 16. Maintenance of quality standards
 - 17. Review submittal schedule; expedite as required
 - 18. Pending requests for information, changes and substitutions
 - 19. Review proposed changes for effect on construction schedule and completion date
 - 20. Pay application status
 - 21. Other business

H. Revision to Minutes:

1. Unless minutes are challenged, in writing, prior to the next regularly scheduled Progress Meeting, they will be accepted as properly summarizing the discussions and decisions of the meeting.
2. Persons challenging minutes shall reproduce and distribute copies of the challenge to all indicated recipients of the particular set of minutes.
3. Challenge to minutes shall be settled as priority portion of "old business" at next regularly scheduled meeting.

PART 2 - PRODUCTS (NOT USED)

PART 3 - EXECUTION (NOT USED)

END OF SECTION

SECTION 01300

SUBMITTALS

PART 1 - GENERAL

Work completed without approved Shop Drawings and/or samples shall be considered installed at the Contractor's risk.

1.01 SHOP DRAWINGS AND DATA

- A. Shop Drawings defined in the General Conditions, shall complement design and construction Drawings, and shall contain sufficient detail to clearly define all aspects of the Construction. These Drawings shall be complete and detailed.
- B. Contractor and Supplier's catalog sheets, brochures, diagrams, illustrations and other standard descriptive data shall be clearly marked with specification title and numbers to identify pertinent materials, product or models. Delete information which is not applicable to the Work by striking or cross-hatching.
- C. If Shop Drawings show variations from Contract requirements because of standard shop practice or for other reasons, the Contractor shall describe such variations in the letter of transmittal. If acceptable, proper adjustment in the Contract shall be implemented where appropriate. If the Contractor fails to describe such variations, the Contractor shall not be relieved of the responsibility for executing the Work in accordance with the Contract, even though such Drawings have been reviewed.
- D. Data on materials and equipment shall include, without limitation, materials and equipment lists, catalog data sheets, cuts, performance curves, diagrams, verification of conformance with applicable standards or codes, materials of construction and similar descriptive material. Materials and equipment list shall, for each item, give the name and location of the Supplier or manufacturer, trade name, catalog reference, size, finish and all other pertinent data.
- E. For all equipment furnished, the Contractor shall provide a list including the equipment name and address and telephone number of the Supplier's representative and service company so that service and/or spare parts can be readily obtained.
- F. The Contractor will obtain an installation list from suppliers and equipment suppliers who propose to furnish equipment or products for submittal to County/Professional along with the required Shop Drawings. The installation list shall include at least 5 installations where identical equipment has been installed and has been in operation for a period of at least 1-year.

1.02 REVIEW OF SHOP DRAWINGS AND SAMPLES

- A. The County /Professional's review of Shop Drawings, Data, and Samples as submitted by the Contractor will be to determine if the items(s) generally conform(s) to the information in the Contract Documents and is/are compatible with the design concept. The County/Professional's review and exceptions, if any, will not constitute an approval of dimensions, connections, quantities, and details of the material, equipment, device, or item shown.
- B. The review of drawings and schedules will be general, and shall not be construed:
 - 1. As permitting any departure from the Contract Documents
 - 2. As relieving the Contractor of responsibility for any errors, including details, dimensions, and materials
 - 3. As approving departures from details furnished by the County/Professional, except as otherwise provided herein
- C. If the drawings or schedules as submitted describe variations and show a departure from the Contract Documents which the County/Professional finds to be in the interest of the County and to be so minor as not to involve a change in Contract Price or Contract Time, the County/Professional may return the reviewed drawings without noting an exception.
- D. "Approved As Noted": Contractor shall incorporate County/Professional's comments into the submittal before release to manufacturer. The Contractor shall send a letter to the County/Professional acknowledging the comments and their incorporation into the Shop Drawing.
- E. "Amend and Resubmit": Contractor shall resubmit the Shop Drawing to the County/Professional. The resubmittal shall incorporate the County/Professional's comments highlighted on the Shop Drawing.
- F. "Rejected": Contractor shall correct, revise and resubmit Shop Drawing for review by County/Professional.
- G. Resubmittals will be handled in the same manner as first submittals. For resubmittals the Contractor shall direct specific attention, in writing or on resubmitted Shop Drawings, to revisions other than the corrections requested by County/Professional on previous submissions. The Contractor shall make any corrections required by the County/Professional.
- H. If the Contractor considers any correction indicated on the Drawings to constitute a change to the Drawings or Specifications, the Contractor shall give written notice thereof to the County/Professional.

- I. When the Shop Drawings have been completed to the satisfaction of the County/Professional, the Contractor shall carry out the Construction in accordance therewith and shall make no further changes therein except upon written instructions from the County/Professional.
- J. No partial submittals will be reviewed. Submittals not deemed complete will be stamped "Rejected" and returned to the Contractor for resubmittal. Unless otherwise specifically permitted by the County/Professional, make all submittals in groups containing all associated items for:
 - 1. Systems
 - 2. Processes
 - 3. As indicated in specific Specifications Sections
All drawings, schematics, manufacturer's product data, certifications, and other Shop Drawing submittals required by a system specification shall be submitted at one time as a package to facilitate interfaces checking.
- K. Only the County/Professional shall utilize the color "red" in marking Shop Drawing submittals.
- L. Failure to comply with any of the above may result in the rejection of Shop Drawings.

1.03 PRODUCT DATA

- A. Submit not less than 6-copies, unless approved by the County/Professional. Mark each copy to identify applicable products, models, options and other data. Supplement manufacturers' standard data to provide information unique to the Work.

1.04 MANUFACTURERS' INSTRUCTIONS

- A. When required in an individual Specification Section, submit manufacturer's printed instructions for delivery, storage, assembly, installation, start-up, adjusting and finishing, in quantities specified for product data.

1.05 SAMPLES

- A. Submit full range of manufacturers' standard colors, textures and patterns for the County's selection. Submit samples for selection of finishes within 30-days after Award of Contract. All color and finish selections must be submitted by the Contractor in a single submission, properly labeled and identified.
- B. Submit samples to illustrate functional characteristics of the product, with integral parts and attachment devices. Coordinate submittal of different categories for interfacing work.

- C. Submit the number of samples specified in the respective Specification section, but no less than two (2). After review one (1) will be retained by the County. Reviewed samples that may be used in the Work are indicated in the Specification Section.
- D. Samples shall be delivered to the County as directed. The Contractor shall prepay shipping charges on samples. Materials or equipment for which samples are required shall not be used in the Work until approved by the County/Professional.
- E. Samples shall be of sufficient size to clearly illustrate:
 - 1. Functional characteristics of the product, with integrally related parts and attachment devices
 - 2. Full range of color, texture and pattern
 - 3. Each sample shall have a label indicating:
 - a. Name of Project
 - b. Name of Contractor and Subcontractor
 - c. Material or equipment represented
 - d. Place of origin
 - e. Name of product and brand (if any)
 - f. Location in Project
 - g. Specification title and number
 - h. Submittal number
 - i. Note: Samples of finished materials shall have additional marking that will identify them under the finished schedules.
- F. The Contractor shall prepare a transmittal letter, in triplicate (3) for each shipment of samples containing the information required in paragraph herein. The Contractor shall enclose a copy of this letter with the shipment and send a copy of this letter to the County/Professional. Approval of a sample shall be only for the characteristics or use named in such approval and shall not be construed to change or modify any Contract requirements.
- G. Approved samples not destroyed in testing shall be sent to the County or stored at the site of the Work. Approved samples of the hardware in good condition may be incorporated in the Work if requested in writing by the Contractor and approved in writing by the County/Professional. Samples that failed testing or were not approved will be returned to the Contractor at the Contractor's expense, if so requested at time of submission.

1.06 FIELD SAMPLES

- A. Provide field samples of finishes as required by individual Specifications sections. Install the sample completely and finished. Acceptable samples in place may be retained in completed Work.

1.07 DRAWINGS, PRODUCT DATA AND CERTIFICATES

- A. Each letter of transmittal shall identify each and every item transmitted by title, drawing number, revision number and date.

- B. The County generally will not check dimensions, quantities or schedules, except in cases where the information is lacking in the Specifications.
- C. The following is applicable to submitted drawings, data and certificates:
 - 1. Show relation to adjacent structures or materials.
 - 2. Clearly identify field dimensions.
 - 3. Show required dimensions and clearances.
 - 4. Performance characteristic and capabilities shall accompany original Shop Drawing submittals.
 - 5. Wiring diagrams and controls shall accompany original Shop Drawing submittals.
 - 6. Installation instructions shall accompany original Shop Drawing submittals.
 - 7. Each submittal shall identify applicable Standards, such as ASTM number or Federal Specification number.
 - 8. All information not pertinent shall be removed from the submittal, or shall be crossed out.
- D. When resubmission is required, the County/Professional will return only two (2) marked up copies. A third submission from the same manufacturer will not be accepted.

1.08 SUBSTITUTIONS

- A. The substitution requirements of this Section are in addition to the requirements of the General Conditions and Supplementary Conditions.
- B. When a particular product is specified or called for, it is intended and shall be understood that the proposal tendered by the Bidder includes those products in his Bid. Substitutions will only be considered in cases where original materials are unavailable or in an instance where substitute can be proven superior in its planned application
- C. The intent of these specifications is to provide the County with a quality facility without discouraging competitive bidding. For products specified only by reference standards, performance and descriptive methods, without naming manufacturer's products, the Contractor may provide the products of any manufacturer complying with the Contract Documents, subject to the review of product data by the County/Professional as specified herein.
- D. The County/Professional's approval is required for substitutions.
- E. The Contract is based on the materials, equipment and methods described in the Contract Documents.
- F. The County/Professional will consider proposals for substitution of materials equipment and methods only when such proposals are accompanied by full and complete technical data and all other information required by the County/Professional to evaluate the proposed substitution.

- G. Do not substitute materials, equipment or methods unless such substitution has been specifically approved for this Work by the County/Professional in writing. The Contractor must provide a submittal per this Section specifically requesting approval of the substitution. Failure to specifically identify the requested substitution may invalidate approval of a submittal.

1.09 AVAILABILITY OF SPECIFIED ITEMS

- A. Verify prior to bidding that all specified items will be available in time for installation during Construction for orderly and timely progress of the Work.
- B. In the event that specified items will not be available, notify the County/Professional prior to receipt of proposals.

1.10 OPERATING MANUALS

- A. Submit all manuals in accordance with requirements of Divisions 2 through 16 of the Contract Specifications and Section 01700 "Project Closeout."

1.11 WARRANTIES, GUARANTEES AND BONDS

- A. Provide as required by Technical Sections of the Specifications and Sections 01700 "Project Closeout" and Section 01740 "Warranties and Bonds."

1.12 CADD FILES

- A. The Professional's CADD files will be available on a limited basis to qualified firms at the County's prerogative. The procedure for requesting such files is noted elsewhere in these documents and there is a cost associated with handling and reproduction. Recipients are cautioned that these files may not accurately show actual conditions as constructed. Users are responsible to verify actual field conditions.
- B. The Professional's Drawings are to be used only for background information. If the Professional's Drawings are just reproduced and resubmitted (e.g. for ductwork drawings) they will be rejected.
- C. Copies of data furnished by the County/Professional to Contractor or Contractor to County/Professional that may be relied upon are limited to the printed copies (also known as hard copies). Files in electronic media format of text, data, graphics, or other types are furnished only for the convenience of the receiving party. Any conclusion or information obtained or derived from such electronic files will be at the user's sole risk. If there is a discrepancy between the electronic files and the hard copies, the hard copies govern.

- D. Because data stored in electronic media format can deteriorate or be modified inadvertently or otherwise without authorization of the data's creator, the party receiving electronic files agrees that it will perform acceptance tests or procedures within 60-days, after which the receiving party shall be deemed to have accepted the data thus transferred. Any errors detected within the 60-day acceptance period will be corrected by the transferring party.
- E. When transferring documents in electronic media format, the transferring party makes no representations as to long-term compatibility, usability, or readability of documents resulting from the use of software application packages, operating systems, or computer hardware differing from those used by the data's creator.

1.13 PROGRESS PHOTOGRAPHS

- A. Photographs and digital pictures shall be in color. Provide 1 copy of each digital picture on each of three (3) CDs and provide 1 print of each photograph in two (2) separate albums.
- B. Photographs shall be from locations to illustrate the condition of Construction and state of progress adequately.
- C. Provide up to 12 digital photographs of views randomly selected by the County, taken prior to any construction and prior to each scheduled Application for Payment.
- D. Deliver electronic images, prints, and negatives to the County.
- E. Each print shall be single weight paper with glossy finish and the overall dimension shall be 7-1/2-inch x 10-inches (19.05 x 25.4 cm). The print shall be clear, sharp and free of distortion after the enlargement from the negative.
- F. Provide loose-leaf albums for each set of photographs to hold prints with a maximum of 50-leaves per binder.
- G. Each print shall be protected by flexible, transparent acetate or plastic sheet protector leaves with metal reinforced holes. Two (2) extra leaves shall be provided in each binder.
- H. Capture and provide digital, ortho-rectified, true-color, aerial photographs of the complete project site prior to start of Construction and at final completion. A final 6-inch or less ground pixel resolution is required. If using traditional photography, the photos will need to be captured at an appropriate scale and scanned at a high enough dpi to yield a final ground pixel size of 6-inches or less. If captured digitally, a final 6-inches or less ground sample distance is required. The final orthorectified photos shall use a projection of NAD 27, State Plane West and all vertical reference shall be NAVD 88, US feet. All orthophoto mosaics shall meet a final accuracy of plus or minus 5-feet.

- I. Provide a total of four (4) true-color, color balanced orthophoto mosaic prints. Three (3) prints each of the pre and post construction (final completion) orthophoto mosaics, for a total of six (6). Each orthophoto mosaic print shall be on double-weight paper with glossy finish and shall have overall dimensions of 36-inches x 58-inches. Two (2) copies of each of the digital orthophoto mosaics shall be supplied in Geotiff format on disk for each time period (pre and post construction). The final color balanced, true-color orthophoto mosaics will be projected in NAD 27, State Plane West and all vertical reference shall be NAVD 88, US feet and shall meet a final accuracy of plus or minus 5-feet.
- J. The Contractor shall provide before and after photographs of each portion of the site. The below ground facilities shall include all equipment, walls, floor, piping, supports and entrance. At major locations, photographs shall include before, during, and after prints and all prints shall be placed in binders in ascending date order to show the Work as it progresses.
- K. Descriptive Information:
 - 1. Each photograph shall have a permanent title block on the back and shall contain the typed information and arrangement as follows:
 - a. ORANGE COUNTY, FLORIDA
 - b. (ENTER PROJECT NAME)
 - c. BID No. (Enter Bid Number)
 - d. CONTRACTOR: (Name of Contractor)
 - e. DATE: (When photo was taken)
 - f. PHOTO NO.: (Consecutive Numbers)
 - g. PHOTO BY: (Firm Name of Photographer)
 - h. LOCATION: (Description of Location and View)
 - 2. The Contractor shall provide the Professional with a written description of each photograph. This description shall be included in the binders and a copy shall be submitted with the CDs.

1.14 PROJECT RECORD DOCUMENTS

Project Record Documents shall be submitted in accordance with Section 01720 "Project Record Documents" of these specifications.

PART 2 - PRODUCTS (NOT USED)

PART 3 - EXECUTION

3.01 SUBMITTAL PROCEDURES

- A. Article 9 of the General Conditions contains additional provisions regarding submittals.

- B. Preliminary Shop Drawing Data: Within 20-days after the Award of the Contract or before the Pre-Construction Meeting, the Contractor shall submit to the County/Professional a complete listing of manufacturers for all items for which Shop Drawings are to be submitted.
- C. Shop Drawing Submittal Schedule: Within 30-days after the Notice to Proceed, the Contractor shall submit to the County/Professional a complete schedule of Shop Drawings submittals with the respective dates for submission, the beginning of manufacture, testing and installation of materials, supplies and equipment, noting those submittals critical to the progress schedule.
- D. Submittal Log: An accurate updated log of submittals will be maintained by the Contractor and subject to review by the County/Professional at each scheduled progress meeting.
- E. If the Contractor considers any correction indicated on the Drawings to constitute a change to the Contract Drawings or specifications, the Contractor shall give written notice thereof to the County/Professional. This does not constitute a change order until accepted by the County.
- F. Shop Drawing and submittal data shall be reviewed by the County/Professional for each original submittal and first resubmittal; thereafter review time for subsequent resubmittals shall be charged to the Contractor. The Contractor shall reimburse the County for services rendered by the County/Professional at the rate multiplied by the County's Professional multiplier based on the fee schedule provided to the County for this Project. If a County engineer is performing any portion of the review, this fee is based upon the hourly rate of the engineer times the County's multiplier for overhead, benefits, and expenses. The Contractor agrees that the County shall deduct such charges from the Contract Amount by a deductive Change Order.
- G. Contractor Shop Drawing and Sample submittals shall include 5 copies in addition to any other copies that the Contractor wants returned. The County will retain 5 copies of approved submittals.
- H. Identify Project, Project Number, date, dates of previous submittals, Contractor, Sub-Contractors, suppliers with their addresses, pertinent Drawings by sheet and detail number, and Specification Section number, as appropriate. Identify all deviations from the Contract Documents. Provide space for Contractor and Professional review stamps.
- I. Contractor's delivery of Shop Drawings for review shall follow a reasonable sequence, as is necessary to support the dates on the Progress Schedule and avoid an overload of Shop Drawings awaiting review at any one time. Coordinate submittal of related items.

- J. Submit Shop Drawings per the schedule of Shop Drawing submittals, inserted in 1 loose-leaf binder, with tabs and index to the County/Professional. All individual submittal sheets inserted in said binder must be clearly marked and referenced to proper paragraph and subparagraph of specifications. Cross out any items on sheets which constitute information not pertaining to equipment specified. Clearly mark all components that are provided as "optional" by manufacturer. Shop Drawings shall be approved by the Contractor prior to submittal to the County/Professional. Shop Drawings will be reviewed by the County/Professional. After County/Professional approval, reproduce and distribute in accordance with requirements herein.
- K. All submissions of Shop Drawings, brochures and catalog cuts shall be accompanied by a transmittal letter listing the Drawings submitted by number and title.
- L. When engineering calculations and/or professional certification of performance criteria of materials, systems, and/or equipment are required, the County is entitled to rely upon the accuracy and completeness of such calculations and certifications submitted by the Contractor. Calculations, when required, shall be submitted in a neat, clear and in an easy to follow format. Such calculations and/or certifications shall be signed and sealed by a Professional Engineer registered in the State of Florida.
- M. Distribute copies of reviewed submittals to concerned parties. Instruct recipients to promptly report any inability to comply with provisions.
- N. Prior to submission of Shop Drawings and samples, the Contractor shall stamp and sign the submittals. Any submission which, upon examination by the County, shows evidence of not having been thoroughly checked, or is not in compliance with the provisions of this Section will be returned to the Contractor for completion before it will be considered for review.
- O. Notify the County of the need for making any changes in the arrangement of piping, connections, wiring, manner of installation, etc., which may be required by the material or equipment Contractor proposes to supply.
- P. On resubmittals, direct specific attention in writing or on the revised Drawings or sample to revisions other than the corrections required by County on previous submissions.
- Q. All drawings, schematics, manufacturer's product data, certifications and other drawing submittals required for a system specification shall be submitted at one time as a package to facilitate interface checking.
- R. The County will distribute Shop Drawings as follows for the indicated action taken:

SHOP DRAWING SUBMITTAL DISTRIBUTION

Representative Party	No Exception Taken or Make Correction Noted			Rejected or Revise & Resubmit		
	Submittal Transmittal	Shop Drawing	Review Comment Sheet	Submittal Transmittal	Shop Drawing	Review Comment Sheet
Engineer	2 Copies	File Copy	1 Copy	Original	File Copy	1 Copy
Contractor (see Note 1)	2 Copies	1 Copy Each Submittal	1 Copy	1 Copy	All Copies Except Engineers	1 Copy
County	1 Copy	1 Copy Each Submittal	1 Copy	1 Copy	None	1 Copy
Inspector	2 Copies	1 Copy Each Submittal	1 Copy	1 Copy	None	1 Copy
Project Record Data (see Note 2)	1 Copy	1 Copy Each Submittal	1 Copy	1 Copy	None	1 Copy

NOTES:

1. Contractor shall distribute additional copies to Subcontractors as required.
2. Stored by Contractor to be furnished to County upon closeout.

- S. All Shop Drawings shall be accompanied with a transmittal letter providing the following information:
1. Project Title and Contract Number
 2. Date
 3. Contractor's name and address
 4. The number of each Shop Drawing, project data, and sample required
 5. Notification of Deviations from Contract Documents
 6. Submittal Log Number conforming to specification section numbers
 - a. Submit each specification section separately.
 - b. Identify each Shop Drawing item required under respective specification section.
 - c. Identify resubmittal using specification section followed by A (first resubmittal), B (second resubmittal)...etc.

3.02 CONTRACTOR'S REVIEW

- A. Contractor's Responsibility for Coordination: Where the dimension, size, shape, location, capacity or other characteristic affects another item, and where the Contractor selects, fabricates or installs related or adjacent products to be used, the Contractor shall be responsible for coordination of related items. The Contractor shall insure that a proper exchange of information takes place prior to or during preparation of each submittal and that submittals reflect such coordination. The notation "verify" or "coordinate" on the Drawings indicates the necessity for Contractor coordination in the particular instances used.

- B. Contractor's Checking: When checking submittals from Subcontractors and suppliers, the Contractor shall mark all sets, indicating his corrections and comments in blue or green. Copies marked in red may be returned for revision.
- C. The Contractor is responsible to deliver and pick-up all submittals in a timely manner at the County/Professional's designated office. The Contractor is responsible for all related costs and expenses for the transmittal of such submittals.

3.03 COUNTY'S / PROFESSIONAL'S REVIEW

- A. Corrections or comments made on Shop Drawings during review do not relieve the Contractor from compliance with the requirements of Drawings and Specifications. This check is only for review of general conformance with the design concept of this Project and general compliance with information given in Contract Documents. Any substitutions or changes shall be properly noted.
- B. No action will be taken on "rough-in" Shop Drawings for plumbing and electrical connections when the items of equipment are not included in the same submittal.
- C. Review Time:
 - 1. On a normal basis, each submittal will be returned to the Contractor within 15 working days of the date it is received. Some submittals may require additional time.
 - 2. If, for any reason, the above schedule cannot be met, the Contractor will be so informed within a reasonable period and the Schedule of Submittals revised. If the specific submittal affects the critical path, the Contractor shall immediately notify the County/Professional in writing. In the event of separate submittals of individual components of a system, these submittals may be held until all components of the system are submitted, and the Contractor will be so notified.

END OF SECTION

SECTION 01301
PRODUCT SUBSTITUTIONS

PART 1 - GENERAL

1.01 SUMMARY

A. General

1. Base all bids on materials and equipment specified in the Appendix D Orange County Utilities List of Approved Products.
2. Certain types of equipment and kinds of material are described in specifications by means of references to names of manufacturers and vendors, trade names, or catalog numbers.
 - a. When this method of specifying is used, it is not intended to exclude from consideration other products bearing other manufacturer's or vendor's names, trade names, or catalog numbers, provided said products are "or-equals," as determined by County/Professional.
3. Other types of equipment and kinds of material may be acceptable substitutions under the following conditions:
 - a. Or-equals are unavailable due to strike, discontinued production of products meeting specified requirements, or other factors beyond control of Contractor; or,
 - b. Contractor proposes a cost and/or time reduction incentive to the Owner.

1.02 QUALITY ASSURANCE

A. In making request for substitution or in using an approved product, Contractor:

1. Has investigated proposed product, and has determined that it is adequate or superior in all respects to that specified, and that it will perform the function for which it is intended.
2. Will provide same guarantee for substitute item as for product specified.
3. Waives all claims for additional costs related to substitution which subsequently arise.

1.03 DEFINITIONS

- A. Product: Manufactured material or equipment.

1.04 PROCEDURE FOR REQUESTING SUBSTITUTION

A. Substitution shall be considered only:

1. After award of Contract
2. Under the conditions stated herein

- B. Written request through Contractor only.

C. Transmittal Mechanics

1. Follow the transmittal mechanics prescribed for Shop Drawings in Specification Section 01300 "Submittals."
 - a. Product substitution will include in the transmittal letter, either directly or as a clearly marked attachment, the items listed in Paragraph D below.

D. Transmittal Contents

1. Product identification:
 - a. Manufacturer's name
 - b. Telephone number and representative contact name
 - c. Specification Section or Drawing reference of originally specified product, including discrete name or tag number assigned to original product in the Contract Documents.
2. Manufacturer's literature clearly marked to show compliance of proposed product with Contract Documents.
3. Itemized comparison of original and proposed product addressing product characteristics including but not necessarily limited to:
 - a. Size
 - b. Composition or materials of construction
 - c. Weight
 - d. Electrical or mechanical requirements
4. Product experience
 - a. Location of past projects utilizing product.
 - b. Name and telephone number of persons associated with referenced projects knowledgeable concerning proposed product.
 - c. Available field data and reports associated with proposed product.
5. Data relating to changes in construction schedule.
6. Data relating to changes in cost.
7. Samples
 - a. At request of County/Professional.
 - b. Full size if requested by County/Professional.
 - c. Held until substantial completion.
 - d. County/Professional is not responsible for loss or damage to samples.

1.05 APPROVAL OR REJECTION

- A. Written approval or rejection of substitution to be given by the Engineer.
- B. Engineer reserves the right to require proposed product to comply with color and pattern of specified product if necessary to secure design intent.
- C. In the event the substitution is approved, the resulting cost and/or time reduction will be documented by Change Order in accordance with the General Conditions.
- D. Substitution will be rejected if:
 1. Submittal is not through the Contractor with his stamp of approval.
 2. Request is not made in accordance with this Specification Section.

3. In the County/Professional's opinion, acceptance will require substantial revision of the original design.
 4. In the County/Professional's opinion, substitution will not perform adequately the function consistent with the design intent.
- E. Contractor shall reimburse the County for the cost of the evaluation whether or not substitution is approved.

PART 2 - PRODUCTS - (NOT USED)

PART 3 - EXECUTION - (NOT USED)

END OF SECTION

THIS PAGE LEFT BLANK INTENTIONALLY

SECTION 01310
PROGRESS SCHEDULES

PART 1 - GENERAL

1.01 REQUIREMENT

- A. The Contractor will submit precedence method cost loaded Critical Path Method (CPM) Progress Schedules to the County depicting the approach to prosecution and completion of the Work. This requirement includes, but is not limited to the Contractor's approach to Activity cost loading, recovering schedule and managing the effect of changes, substitutions and Delays on Work sequencing.
- B. The Progress Schedule shall show how the Contractor's priorities and sequencing for the Work (or Work remaining) conform to the Contract requirements and the sequences of Work indicated in or required by the Contract Documents; reflect how the Contractor anticipates foreseeable events, site conditions and all other general, local and prevailing conditions that may affect cost, progress, schedule, furnishing and performance of the Work; and show how the Contractor's Means and Methods translate into Activities and logic.
- C. The Progress Schedule will consist of the Initial Submittal, Payment Submittals and Revision Submittals. Upon acceptance by the County, the Initial submittal will become the As-Planned Schedule for the Work. Revision submittals upon acceptance will become the As-Planned Schedule for the Work remaining to be completed as of the submittal date for that Revision.
- D. References to the Critical Path Method (CPM) are to CPM construction industry standards that are consistent with the requirements of this Section.

1.02 GLOSSARY OF TERMS

- A. The following terms, whether or not already defined elsewhere in the Contract Documents, have the following intent and meanings within this Section:
 - 1. Activity Value (Value): That portion of the Contract Price representing an appropriate level of payment for the part of the Work designated by the Activity.
 - 2. As-Planned Schedule: The first, complete Initial Progress Schedule submitted by the Contractor with the intent to depict the entire Work as awarded and accepted by the County or returned as no resubmittal required.
 - 3. Contract Float: Days between the Contractors anticipated date for completion of the Work, or of a specified portion of the Work, if any, and the corresponding Contract Time.

4. CPM Schedule: The Progress Schedule based on the Critical Path Method (CPM) of scheduling. The term Critical Path means any continuous sequence of Activities in the Progress Schedule controlling, because of their sum duration, the Early Date of a pertinent, specified Contract Time.
5. Early/Late Dates: Early/late times of performance, based on CPM calculations, for an Activity in the Progress Schedule. Early Dates will be based on proceeding with all or part of the Work on the date when the corresponding Contract Time commences to run. Late Dates will be based on completing all or part of the Work on the corresponding Contract Time, even if the Contractor plans early completion.
6. Milestones: Key, pre-determined points of progress in the completion of a facility, denoting interim targets in support of the Contract Times. Milestones may pinpoint targets for key excavation and substructure events, significant deliveries, critical path transition from superstructure to piping and electrical rough in and building enclosure. Also, hook-up of mechanical and electrical equipment, availability of power for testing, equipment shakedown, training of County personnel, start -up, Substantial Completion and other events of like import.
7. Official Schedule: The Initial or most recent Revision Submittal accepted by the County or returned as no resubmittal required and the basis for Payment Submittals until another Revision Submittal is submitted and accepted. The accepted Initial Submittal is also the As-Planned Schedule.
8. Payment Submittal: A monthly Progress Schedule update reflecting progress and minor adjustments on the Activities, sequencing and restraints for Work remaining.
9. Total Float: Days by which an activity may slip from its Early Dates without necessarily extending a pertinent Contract Time. Total Float at least equals Contract Float. Total Float may also be calculated and reported in working Days. When an activity is delayed beyond Early Dates by its Total Float it becomes a Critical Path activity and if delayed further will impact a Contract Time.

1.03 QUALITY ASSURANCE

- A. The Contractor may self-perform the Work covered by this Section or employ a Subcontractor, subject to the County's consent. Employment of a scheduling Subcontractor shall not in any way alter or reduce the Contractor's obligations under the Contract Documents.
- B. The Contractor will obtain a written interpretation from the County, if the Contractor believes that the selection of activities, logic ties and/or restraints requires a written interpretation of the Contract Documents. With each submission, the Contractor will point out by specific, written notation, any Progress Schedule feature that may reflect variations from any requirements of the Contract Documents.
- C. It is the Contractor's responsibility to obtain information directly from each Subcontractor and Supplier when scoping their respective Activities, Values, logic ties and restraints.

- D. Neither Acceptance nor Review of any Progress Schedule will relieve the Contractor from the obligation to comply with the Contract Times and any sequence of Work indicated in or required by the Contract Documents and to complete, within the Contract Times, any Work omitted from that Progress Schedule.
- E. Neither Acceptance nor Review of any Progress Schedule will imply approval of any interpretation of or variation from the Contract Documents, unless expressly approved by the County through a written interpretation or by a separate, written notation on the returned Progress Schedule Submittal.

1.04 MILESTONES AND SCHEDULE RECOVERY

- A. The County will select Milestones and Milestone Dates on the basis of the As-Planned Schedule. As the Official Schedule is revised, Milestone Dates will be revised accordingly. Milestone Dates will serve as target dates.
- B. Whenever any Activity slips by 14 or more Days from the Late Date for an activity in the Official Schedule, Milestone Dates selected by the County, or a pertinent Contract Time, the Contractor will deliver a Revision Submittal documenting the Contractor's schedule recovery plan and/or a properly supported request for an extension in the Contract Time. The narrative will identify the Delay and actions taken by the Contractor to recover schedule, whether by adding labor, Subcontractors or construction equipment, activity re-sequencing, expediting of submittals and/or deliveries, overtime or shift Work, and so forth. Activity shortening and overlapping shall be explained as to their basis (and be supported by increases in resources).
- C. Upon evaluation of that Revision Submittal, if the County determines there is sufficient cause, the County may withhold liquidated damages or provide a notice of intent to do so, if schedule is indeed not recovered, and/or may give a notice of default.

1.05 PROGRESS SCHEDULE SOFTWARE

- A. The scheduling software employed by the Contractor to process the Progress Schedule will be the current version of Primavera P6.0®, or Primavera® Contractor 5.0 CPM scheduling software.
- B. If the Contractor intends to use companion schedule reporting, analysis or graphics software tools, the Contractor will furnish to the County descriptive materials and samples describing such software tools.

1.06 NON-PERFORMANCE

- A. The County may refuse to recommend all or any part of any payment, if the Contractor fails, refuses or neglects to provide the required Progress Schedule information on a timely basis. Partial payments without a properly updated Progress Schedule shall be returned to the Contractor as non-conforming.

- B. If justified under the circumstances, the County also may prepare alternate Progress Schedules, as appropriate, and deduct from the Contract Amount all related costs by Change Order and/or take other action commensurate with the breach.

1.07 REPORTS, SCHEDULES AND PLOTS

- A. Schedule Reports will include Activity (ID) code and description, duration, calendar, Early Dates, Late Dates and Total Float. Separate Schedule Reports will tabulate, for each Activity, all preceding and succeeding logic types and lead times, whether CPM Plots displaying logic ties are appended or not.
- B. CPM Schedule Plots will be plotted on a suitable time scale and identify the Contract Times, Critical Paths, phases and work areas on 24-inch x 36-inch or smaller sheets. Activities will be shown on the Early Dates with Total Floats noted by Late Date flags. For Payment and Revision Submittals plot a target comparison based on the current Official Schedule.
- C. The Activity Value report will tabulate Activity code and description and Activity Value, percent complete and earned value as calculated by the scheduling software. Cash flow plots shall be provided showing the monthly and cumulative actual and planned earned values with curves shown for Early and Late Dates in the schedules. For Payment and Revision Schedule submittals, the cash flow curves shall also plot the most current Official Schedule planned earnings curves.
- D. Each submittal shall include listings of all added and deleted activities, logic, constraints, Activity Value changes and update information vs. the previous Progress Schedule submittal. This list may be manually prepared or generated by accessory software that will generate such listings.

1.08 NARRATIVE REQUIREMENTS

- A. The Initial Submittal narrative will describe the Contractor's approach to prosecution of the Work and the basis for determination of activity durations, sequence and logic, including the Contractor's management of the site, e.g., lay down, staging, parking, etc.; Contractor's phasing of the Work; use of crewing and construction equipment; identification of non-work County/Professional's, shifts, weekend Work and multiple calendars applied to activities and an explanation of the basis for restraint dates.
- B. Revision and Payment Submittal narratives will explain any changes to the approach or planning referred to in Paragraph A above on account of any change, delay, schedule recovery, substitution and/or Contractor-initiated revision occurring since the previous submittal.
- C. Each narrative will list the Critical Path Activities and compare Early and Late Dates against Contract Times and Milestone Dates. Narratives shall also recap progress and Days gained or lost vs. the current Official Schedule, and identify delays, their extent and causes.

- D. The Initial Submittal narrative will describe all delays occurring since Contract Award and all pending and anticipated "or equal" and substitution proposals. Payment and Revision Submittal narratives will describe any new delays and shall certify that the Contractor has not been delayed, as of the cut off date, by any acts or omissions of the County, except as otherwise specifically stated.

1.09 ACTIVITY REQUIREMENTS

- A. Separate activities will identify permits, design when included in the Work, construction, Submittal preparation and review (and resubmission and re-review), deliveries (site or storage), testing, start-up, commissioning and Punch List.
- B. Activities will be detailed to the extent required to show the transition of trade Work. Activities will delineate the progression of the Work.
- C. Activities will not combine separate or non-concurrent items of Unit Price or lump sum Work.
- D. Activity durations will equal the Work Days required to sufficiently complete the Work designated by the Activity, (i.e., when finish-to-start successors could start, even if the Activity is not quite 100% complete). Installation Activities will last from 10 to 40 workdays. Submittal review activity durations shall conform to specified timeframes.
- E. Activities will be assigned consistent descriptions and identification codes. Sort codes will group Activities by meaningful schemes.
- F. Activities will be assigned Activity Values as appropriate and needed to reasonably allocate the Contract Amount to the time periods that they will be earned and eligible for payment based on the Progress Schedule and Schedule of Values. Separate pay activities may be used to simplify cost loading of the Progress Schedule. When used, pay activities shall be loaded with the cost of Work that is included, at no cost, in related (generally, concurrent) CPM activities. Pay activities shall not control the rate of progress; however, their start and finish dates shall be consistent with those of their related CPM activities to ensure accurate Early Date and Late Date cash-flow plots.

1.10 FLOAT TOLERANCES AND FLOAT OWNERSHIP

- A. Any Progress Schedule with Early Dates after a Contract Time will yield negative Total and Contract Floats, whether shown/calculated or not. Any Revision Submittal with less than negative 20-days of Float will be returned as "Revise and Resubmit," unless a time extension is requested or the County assesses liquidated damages or gives notice of intent to do so, in the event schedule is not recovered.
- B. Float calculated from the definitions given in this Section supersede any conflicting Float values in any early completion Progress Schedule.

- C. Neither the County nor the Contractor own the Float time, the Project owns the Float time. Neither the County nor the Contractor use of positive Total Float will impact a Contract Completion Date or justify an extension of Contract Time.

1.11 SUBMITTALS

- A. Each Progress Schedule Submittal will consist of a narrative, 5 copies of the required reports and plots and an optical ROM data disk with the Contractor's corresponding schedule and schedule layout files in Primavera ".XER" format.
- B. The County will review Progress Schedule Submittals and return a review copy within 14-days after receipt and the Contractor shall, if required, resubmit within 7-days after return of the review copy.
- C. Requirements for the Initial Submittal:
 - 1. Within 20-days after receipt of Notice to Proceed and prior to commencing Work on the Project, prepare and submit to the County the Initial Submittal of the Progress Schedule for the Work. The Initial Submittal will show the Work as awarded, without delays, Change Orders or substitutions.
 - a. Activity Values will prorate Schedule of Values costs and/or pay items through to Activities. Provide a cross-reference listing with two parts; a part that will list each activity with the respective amounts allocated from each Schedule of Values and Unit Price Item making up the total value of each activity and a second part that will list the Schedule of Values and Unit Price Items with the respective amounts allocated from each activity that make up the total value of each item.
 - 2. After the As-Planned Schedule is established, the County will select Milestones and record the Milestone Early and Late Dates. As the Official Schedule evolves, Milestone Dates will be revised accordingly.
 - 3. If the County refuses to endorse the Initial Submittal (or a resubmission) as "Resubmittal Not Required," the As-Planned Schedule will not be established. In that event, the Contractor will continue to submit Payment and Revision Submittals reflecting progress and the Contractor's approach to remaining Work. The County will rely on the available Payment and Revision Submittals, subject to whatever adjustments it determines appropriate.
- D. Requirements for Payment Submittals:
 - 1. Payment Submittals with progress up to the closing date and updated Early Dates and Late Dates for progress and remaining Activities will be due with each Progress Payment. As-built data will consist of actual dates, percent complete, earned payment, changes, Delays and other significant events occurring before the closing date.
 - 2. Activity percent complete and earned value should indicate a level of completion that corresponds to the Application for Progress Payment for the same period. The earned value should be calculated by the scheduling software as Activity Value times percent complete. Explanation should be provided whenever the cumulative earned value of activities in a Payment Submittal is not within 10% of the value of Work completed as represented in the corresponding Application for Progress for Payment.

3. At the Contractor's option, a Payment Submittal may overlay minor adjustments on activities and sequencing for Work remaining. This excludes Activity re-scoping to reflect Delays, changes, schedule recovery or substitutions.

E. Requirements for Revision Submittals:

1. Revision Submittals will be submitted when necessary because of major changes or delays affecting activities, sequencing or restraints for Work remaining and/or to put forth a schedule recovery plan. Revision Submittals may also be required because of Contractor-initiated re-planning, or when Contractor plans to perform Work ahead or out-of-sequence that will require additional testing or inspection personnel, or when requested by the County when Work is performed out-of-sequence from the current Official Schedule such that the number of Days gained or lost can not be determined or the scheduled dates of completion of the Work in a Payment Submittal are not viewed as reliable.
2. If requesting a time extension, the Revision Submittal should show the impact of the delay after incorporating reasonable mitigation to minimize the impact and illustrate how the number of Days requested time extension was determined. The delay should be determined as the change in the forecast Contract Completion Date(s) resulting solely from delays that entitle the Contractor to a time extension as provided in the General Conditions. Any and all Contractor slippage and delay occurring prior to and concurrent with the delay potentially entitling the Contractor to a time extension shall be incorporated in the Revision and explained such that the concurrent and non-concurrent periods of delay are indicated. If the Contractor does not follow the procedures contained in this Section or, if the Contractor's analysis is not verifiable by an independent, objective evaluation by the County using the electronic files and data furnished by the Contractor, any such extension in Contract Time will not be granted.

F. Retrospective Delay Analysis.

1. If the County/Professional refuses to endorse any Revision Submittal as "Resubmittal Not Required," the Contractor and County will use the latest Official Schedule when evaluating the effect of Delays on Contract Time and/or Contract Price. The procedure to be used will consist of progressively updating the latest Official Schedule at key closing dates corresponding to starting and finishing dates of the delays and/or dates the delays became critical or dates the Critical Path may have changed for other reasons. For each Progress Schedule iteration, slippage between actual Milestone Dates and Initial Milestone Dates will be correlated to Delays occurring solely in that iteration.
2. For each iteration, revisions in Activities, logic ties and restraints affecting Work after the closing date will be included in that Progress Schedule only if they meet any of the following conditions. First, they are Progress Schedule revisions that the County consented to contemporaneously (i.e., before the closing date) in writing. Second, they reflect comments or objections raised by or on behalf of the County and that were actually confirmed by the as-built progress. Lastly, they represent Contractor's schedule recovery plans or other Progress Schedule revisions that were actually confirmed by the as-built progress.

PART 2 - PRODUCTS (NOT USED)

PART 3 - EXECUTION (NOT USED)

END OF SECTION

SECTION 01370
SCHEDULE OF VALUES

PART 1 - GENERAL

1.01 DEFINITION

- A. Schedule of Values: Schedule that divides the Contract Amount into pay items, such that the sum of all pay items equals the Contract Amount for the Work, or for any portion of the Work having a separate specified Contract Amount.

1.02 REQUIREMENT

- A. The Schedule of Values established as provided in the General Conditions will serve as the basis for progress payments and will be incorporated into a form of Application for Payment acceptable to the County. Progress payments on account of Unit Price Work will be based on the number of units completed.
- B. No payment will be made for Work performed on a lump sum contract or a lump sum item until the appropriate Schedule of Values is approved by the County.
- C. The equitable value of Work deleted from a lump sum contract or lump sum item shall be determined from the approved Schedule of Values.

1.03 SUBMITTALS

- A. Submit 3 copies of a Preliminary Schedule of Values within 15-days after the recommended award of the Contract.
- B. Submit 3 copies of a proposed final Schedule of Values within 20-days after receipt of Notice to Proceed as per the General Conditions.
- C. Submit the Schedule of Values, typed, on EJCDC 1910-8-E form or Orange County forms or spreadsheets provided by County. The Contractor's standard form or electronic media printout will be considered for acceptability by the County.
- D. List installed value of each major item of Work and each subcontracted item of Work as a separate line item to serve as a basis for computing values for Progress Payments. Round off values to nearest dollar.
- E. Coordinate listings with the Progress Schedule.
- F. For items on which payments will be requested for stored materials or equipment, list sub-values for cost of stored products with taxes paid.
- G. Submit a sub-schedule for each separate stage of Work specified in Section 01010 "Summary of Work."

- H. The sum of values listed shall equal the total Contract Amount for the Work or the Contract Amount for a part of the Work with a separate Contract Amount provided for by the Contract Documents.
- I. When the County requires substantiating information, submit data justifying line item amounts in question.

1.04 UNIT PRICE CONTRACTS

- A. For unit price contracts, the bid item prices on the Project Bid Schedule shall be used as the basis for the schedule of values. The Contractor shall resubmit the bid item prices in the format described herein, and may, at its option, or if requested by the County, divide the items in the Project Bid Schedule into sub-items to provide a more detailed basis of payment.

1.05 LUMP SUM CONTRACTS

- A. For lump sum contracts, if the Work involves separate facilities, e.g. multiple pump stations, the cost of the Work shall be separated by each facility and into schedule of value items. Break principal subcontract amounts down into these items; The lump sum cost for each facility shall be submitted individually and split into the schedule of values listed in items 1 through 14.
 - 1. Demolition of existing pump station
 - 2. Bypass pumping
 - 3. Wetwell structure, liner, top slab, hatch covers and appurtenances
 - 4. Valve vault structure, hatch covers and appurtenances, drain piping and appurtenances
 - 5. Wetwell (mechanical): 316 stainless steel piping and appurtenances, pumps and base plates
 - 6. Valve vault (mechanical): piping, valves, and appurtenances
 - 7. Yard piping, fittings, valves, and appurtenances (outside of structures)
 - 8. Site work and access drive
 - 9. Chain link fence and gates
 - 10. Masonry walls and gates
 - 11. Odor control equipment, piping, monitoring equipment, etc
 - 12. Generator, fuel storage tank and related piping
 - 13. Electrical control panel, wiring, and connections
 - 14. Start-up and testing

PART 2 - PRODUCTS (NOT USED)

PART 3 - EXECUTION (NOT USED)

END OF SECTION

SECTION 01380
AUDIO – VISUAL DOCUMENTATION

PART 1 - GENERAL

1.01 PURPOSE AND DESCRIPTION OF WORK

- A. The purpose of the audio - visual documentation is to provide the County with regularly documented audio - visual records of the Construction process from the existing conditions through final completion.

1.02 PRE-CONSTRUCTION VIDEO REQUIREMENTS INCLUDED

- A. The Contractor shall employ a professional videographer to take a Pre-Construction video of the entire site including the areas of adjacent properties within 100-feet of the limits of Work and shall be made within 30-days of Work beginning. Special attention shall be made to show the existing paved roads, shoulders, signs, and other existing features.
- B. The Contractor shall submit a quality audio-video recording documenting Pre-Construction field conditions for the entire project. When the Work includes construction of water, wastewater, reuse, or other lines in the vicinity of any street or road, the Contractor shall take digital audio-video recordings of existing conditions along both sides of the street or road. The Pre-Construction video shall be submitted to the County and accepted prior to commencing any Work or using any Contractor laydown areas.
- C. Electronic digital photography shall also be used as necessary to record and facilitate resolution of on-site issues through the transmission of electronic photographs by e-mail from the site to the Professional's and County's offices.

PART 2 - PRODUCTS

2.01 AUDIO-VIDEO RECORDING

- A. Each audio-video recording shall be saved on appropriate DVD media viewable on standard DVD players or computer.

- B. Each DVD shall contain the following information and arrangement at the beginning as a title screen:
- Orange County, Florida
 - PROJECT NAME
 - PROJECT NUMBER
 - CONTRACTOR: (Name of Contractor)
 - DATE: (When photo was taken)
 - VIDEO BY: (Firm Name of Videographer)
 - LOCATION: (Description of Location(s) and View(s))
- C. Each DVD recording section shall begin with an audio description of the County's name, Contract name and number, Contractor's name, date and location information such as street name, direction of travel, viewing side, etc.
- D. Information appearing on the video recording must be continuous and run simultaneously by computer generated transparent digital information. No editing or overlaying of information at a later date will be acceptable.
- E. Digital information to appear in the upper left corner shall be as follows:
1. Name of Contractor
 2. Day, date and time
 3. Name of Project & Specification Number
- F. Time must be accurate and continuously displayed on the video record
- G. Written documentation must coincide with the information on the DVD so as to make easy retrieval of locations at a later date.
- H. The video system shall have the capability to transfer individual frames of video electronically into hard copy prints or photographic negatives.
- I. Audio shall be recorded at the same time as the video recording and shall have the same information as on the viewing screen. Special commentary shall be given for unusual conditions of buildings, sidewalks and curbing, foundations, trees and shrubbery, structures, equipment, pavement, etc.
- J. All DVDs and boxes shall bear labels with the following information:
1. DVD Number
 2. County's Name
 3. Date of Recording
 4. Project Name and Number
 5. Location and Standing Limit of Video

2.02 CONSTRUCTION PHOTOGRAPHS

- A. The Contractor shall employ a competent photographer to take construction record photographs periodically during the course of the Work.

- B. Prints: Date imprinted 8-inch x 10-inch high resolution glossy single weight color print paper; 5 sets, bound in 3-ring binders to be provided to the County with each respective Application for Payment and distributed by the County as follows:
 - 1. County (2 sets)
 - 2. Engineer (1 set)
 - 3. Contractor (1 set)
 - 4. Project Record Data (1 set stored by Contractor to be furnished to County upon Closeout)

PART 3 - EXECUTION

3.01 VIDEO VIEWS REQUIRED

- A. Complete coverage shall include all surface features within 100-feet of the Work area to be used by the Contractor and shall be supported by appropriate audio description made simultaneously with video coverage. Such coverage shall include, but not be limited to, all existing driveways, sidewalks, curbs, ditches, roadways, landscaping, trees, culverts, headwalls, and retaining walls, equipment, structures, pavements, manholes, vaults, handrails, etc. located within the work zone. Video coverage shall extend to the maximum height of all structures within this zone.
- B. The video recorder shall take special efforts to point out and provide audio commentary on cracking, breakage, damage, and other defects in existing features.
- C. All video recording shall be done during times of good visibility. No video recording shall be done during periods of visible precipitation, or when more than 10% of the ground area is covered with standing water, unless otherwise authorized by County.
- D. Prior to commencement of audio-video recording, the Contractor shall notify the County in writing within 48-hours of the audio-video recording. The County may provide a designated representative to accompany and observe all video recording operations. Audio-video recording completed without a County Representative present will be unacceptable unless specifically authorized by the County.

3.02 AUDIO-VIDEO REQUIREMENTS

- A. Major Locations:
 - 1. The Contractor shall provide color digital video of each major facility and structures and facilities adjacent to the Construction before construction starts.
 - 2. All videos shall be recorded with character generator operating with date, time, and location on screen. During video recording, the Contractor shall narrate video explaining what is being shown. All master videos shall be delivered to the County.

3. The audio and video portions of the recording shall maintain viewer orientation. To this end, overall establishing views of all visible house and business addresses shall be used. In areas where the proposed construction location will not be readily apparent to the video recording viewer, highly visible yellow flags shall be placed, by the Contractor, in such a fashion as to clearly indicate the proposed centerline of Construction. When conventional wheeled vehicles are used as conveyances for the recording system, the vertical distance between the camera lens and the ground shall not exceed 10-feet. The camera shall be firmly mounted such that transport of the camera during the recording process will not cause an unsteady picture.
4. All video recording shall be done during time of good visibility. No video recording shall be done during precipitation, mist or fog. The recording shall only be done when sufficient sunlight is present to properly illuminate the subjects of recording and to produce bright, sharp video recordings of those subjects.
5. The average rate of travel during a particular segment of coverage shall be directly proportional to the number, size and value of the surface features within that construction area's zone of influence. The rate of speed in the general direction of travel of the vehicle used during taping shall not exceed 44-feet per minute.

3.03 PHOTOGRAPHS

- A. A minimum of 3 views (top, upstream, and downstream) each shall generally be taken prior to backfilling pipelines or structures. Photographs shall be provided for:
 1. Utility conflicts/relocations
 2. Manholes
 3. Pump stations
 4. Boring and jacking
 5. Directional drilling pipe entrance and exit
 6. Valve installation
 7. Air release valve installation
 8. Fire hydrant assembly
- B. Photo Identification
 1. Name of Project
 2. Name of Structure
 3. Orientation of View
 4. Date & Time of Exposure
 5. Film numbered identification of exposure

END OF SECTION

SECTION 01400
QUALITY CONTROL

PART 1 - GENERAL

1.01 SITE INVESTIGATION AND CONTROL

- A. Contractor shall verify all dimensions in the field and check field conditions continuously during construction. Contractor shall be solely responsible for any inaccuracies built into the Work due to Contractor's failure to comply with this requirement.
- B. Contractor shall inspect related and appurtenant Work and report in writing to County any conditions which will prevent proper completion of the Work. Failure to report any such conditions shall constitute acceptance of all site conditions, and any required removal, repair, or replacement caused by unsuitable conditions shall be performed by the Contractor at Contractor's sole cost and expense.

1.02 INSPECTION OF THE WORK

- A. The Work shall be conducted under the general observation of representatives of the County acting on behalf of the County to ensure strict compliance with the requirements of the Contract Documents. Such inspection may include mill, plant, shop, or field inspection, as required. The County shall be permitted access to all parts of the Work, including plants where materials or equipment are manufactured or fabricated. Inspection by the County are in addition to the inspections required of Contractor by his QC Representatives.
- B. The presence of the County, however, shall not relieve the Contractor of the responsibility for the proper execution of the Work in accordance with all requirements of the Contract Documents. Compliance is a duty of the Contractor, and said duty shall not be avoided by any act or omission on the part of the County. Further, no requirement of this Contract may be waived or modified except by change order or formal (written) substitution approval.
- C. All materials and articles furnished by the Contractor shall be subject to rigid inspection, and no materials or articles shall be used in the Work until they have been inspected and accepted by the County. No Work shall be backfilled, buried, cast in concrete, hidden, or otherwise covered until it has been inspected. Any Work so covered in the absence of inspection shall be subject to uncovering. Where uninspected Work cannot be uncovered, such as in concrete cast over reinforcing steel, all such Work shall be subject to demolition, removal, and reconstruction under proper inspection and no additional payment will be allowed therefore.

- D. The Contractor is responsible for the Quality of his own work and shall designate a qualified individual, to be approved by the County, who will ensure that all work is performed in strict accordance with the Contract Documents. This quality representative shall inspect the work for the Contractor and provide to the County and the Contractor a report outlining all work accomplished, all inspections, and all testing performed for all days when work is performed. The objective of this report is to provide "Objective Evidence of Compliance" by the Contractor with the requirements of the Contract.

1.03 TIME OF INSPECTION AND TESTS

- A. Samples and testing required under these Specifications shall be furnished and prepared in ample time for the completion of the necessary tests and analyses before said articles or materials are to be used. Except as otherwise provided in the Contract Documents, performance of the required tests will be by the Contractor and all costs therefore will be borne by the Contractor at no cost to the County. Whenever the Contractor is ready to backfill, bury, cast in concrete, hide, or otherwise cover any Work under this Contract, the County shall be notified not less than 24-hours in advance to request inspection before beginning any such Work of covering. Failure of the Contractor to notify the County at least 24-hours in advance of any such inspections shall be reasonable cause for the County to order a sufficient delay in the Contractor's schedule to allow time for such inspection, any remedial, or corrective work required, and all costs of such delays, including its impact on other portions of the Work, shall be borne by the Contractor.

1.04 SAMPLING AND TESTING

- A. When not otherwise specified, all sampling and testing shall be in accordance with the methods prescribed in the current standards of the ASTM, as applicable to the class and nature of the article or materials considered. However, the County reserves the right to use any generally accepted system of inspection which, in the opinion of the County, will ensure the County that the quality of the workmanship is in full accord with the Contract Documents.
- B. Any waiver of any specific testing or other quality assurance measures, whether or not such waiver is accompanied by a guarantee of substantial performance as a relief from the specified testing or other quality assurance requirements as originally specified, and whether or not such guarantee is accompanied by a performance bond to assure execution of any necessary corrective or remedial work, shall not be construed as a waiver of any technical or qualitative requirements of the Contract Documents.
- C. Notwithstanding the existence of such waiver, the County shall reserve the right to make independent investigations and tests as specified in the following paragraph and, upon failure of any portion of the Work to meet any of the qualitative requirements of the Contract Documents, shall be reasonable cause for the County to require the removal or correction and reconstruction of any such Work.

- D. In addition to any other inspection or quality assurance provisions that may be specified, the County shall have the right to independently select, test, and analyze, at the expense of the County, additional test specimens of any or all of the materials to be used. Results of such tests and analyses shall be considered along with the tests or analyses made by the Contractor to determine compliance with the applicable specifications for the materials so tested or analyzed provided that wherever any portion of the Work is discovered, as a result of such independent testing or investigation by the County which fails to meet the requirements of the Contract Documents, all costs of such independent inspection and investigation and all costs of removal, correction, reconstruction, or repair of any such Work shall be borne by the Contractor.

1.05 RIGHT OF REJECTION

- A. The County shall have the right at all times and places to reject any articles or materials to be furnished hereunder which, in any respect, fail to meet the requirements of the Contract Documents, regardless of whether the defects in such articles or materials are detected at the point of manufacture or after completion of the Work at the site. If the County or inspector, through an oversight or otherwise, has accepted materials or Work which is defective or which is contrary to the Contract Documents, such material, no matter in what stage or condition of manufacture, delivery, or erection, may be rejected by County.
- B. Contractor shall promptly remove rejected articles or materials from the site of the Work after notification or rejection.
- C. All costs of removal and replacement of rejected articles or materials, as specified herein, shall be borne by the Contractor.
- D. If the Contractor fails to remove or replace defective work after notification to do so, the County may have the work removed and replaced by others and deduct all costs from the Contractor's pay requests.

1.06 TESTING LABS

- A. All geotechnical testing laboratory services for field testing will be paid by the County. The lab(s) shall function as independent lab(s) and report independently to the County and the Contractor. The test lab(s) may not approve or allow any deviation from the Contract Documents.

PART 2 - PRODUCTS (NOT USED)

PART 3 - EXECUTION (NOT USED)

END OF SECTION

THIS PAGE LEFT BLANK INTENTIONALLY

SECTION 01410
TESTING AND TESTING LABORATORY SERVICES

PART 1 - GENERAL

1.01 DESCRIPTION

A. Scope of Work:

1. County will employ, and pay for services of an Independent Testing Laboratory to perform Testing specifically indicated on the Contract Documents or specified in the Specifications and may at any other time elect to have materials and equipment tested for conformity with the Contract Documents.
2. Contractor shall cooperate with the laboratory to facilitate the execution of its required services.
3. Employment of laboratory by County shall in no way relieve Contractor's obligations to perform the Work of the Contract.

B. Related Requirements Described Elsewhere:

1. Conditions of the Contract.
2. Respective section of Specifications: Certification of products.
3. Each Specification section listed: Laboratory tests required, and standards for testing.

1.02 LABORATORY DUTIES: LIMITATIONS OF AUTHORITY

A. Submit 5 copies of inspection reports to the County. The reports shall include the following components:

1. Project title and County's project number
2. Testing laboratory name and address
3. Date of report issuance
4. Name and signature of field technician
5. Date of inspections, sampling, and/or testing
6. Record of weather conditions
7. Identification of product tested and associated specification section
8. Testing location
9. Description of testing performed
10. Observations made regarding compliance with the Contract Documents

B. Laboratory is not authorized to:

1. Release, revoke, alter, or enlarge on requirements of Contract Documents
2. Approve or reject any portion of Work
3. Perform any duties of the Contractor

1.03 CONTRACTOR'S RESPONSIBILITIES

A. Cooperate with County's personnel; provide access to Work and manufacturer's operations.

- B. Secure and deliver to the County adequate representational samples of materials proposed to be used and which require testing.
- C. Provide to the County the preliminary design mix proposed to be used for concrete, and other materials mixes which require control by the testing laboratory.
- D. Materials and equipment used in the performance of work under this Contract are subject to inspection and testing at the point of manufacturer or fabrication. Standard specifications for quality and workmanship are indicated in the Contract Documents. The County may require the Contractor to provide statements or certificates from the manufacturers and fabricators that the materials and equipment provided by them are manufactured or fabricated in full accordance with the standard specifications for quality and workmanship indicated in the Contract Documents. All costs of this testing and providing statements and certificates shall be a subsidiary obligation of the Contractor, and no extra charge to the County shall be allowed on account of such testing and certification.
- E. Contractor shall not have direct contact with laboratory or laboratory personnel. All testing shall be coordinated through County.
- F. Furnish incidental labor and facilities:
 - 1. To provide access to Work to be tested.
 - 2. To obtain and handle samples at the Project site or at the source of the product to be tested.
 - 3. To facilitate inspections and tests.
 - 4. For storage and curing of test samples.
- G. Notify County sufficiently in advance of operations to allow for laboratory assignment of personnel and scheduling of tests. When tests or inspections cannot be performed after such notice, reimburse County for laboratory personnel and travel expenses incurred due to Contractor's negligence.
- H. Employ and pay for the services of the same or a separate, equally qualified independent testing laboratory to perform additional inspections, sampling and testing required for the Contractor's convenience.
- I. If the test results indicate the material or equipment complies with the Contract Documents, the County shall pay for the cost of the testing laboratory. If the tests and any subsequent retests indicate the materials and equipment fail to meet the requirements of the Contract Documents, the Contractor shall pay for the laboratory costs directly to the County or the total costs shall be deducted from any payments due to the Contractor.

PART 2 - PRODUCTS (NOT USED)

PART 3 - EXECUTION (NOT USED)

END OF SECTION

SECTION 01516
COLLECTION SYSTEM BYPASS

PART 1 - GENERAL

1.01 SCOPE OF WORK

- A. The Work covered by this section consists of providing all temporary bypassing to perform all operations in connection with the flow of wastewater around pipe segment(s) or pump stations. The purpose of bypassing is to prevent wastewater overflows and provide continuous service to all wastewater customers. The Contractor will maintain wastewater flow in the construction area in order to prevent backup and/or overflow and provide reliable wastewater service to the users of the wastewater system at all times.

1.02 SUBMITTALS

- A. Prior to implementation of any bypass, the Contractor will submit and receive County acceptance of a bypass plan. The Contractor will submit to the County a comprehensive written plan for approval and acceptance that describes the intended bypass for the maintenance of flows during construction. The Contractor will also provide a sketch showing the location of bypass pumping equipment for each pump station or line segment(s) around which flows are being bypassed. The plan will include proposed tanker(s), pump(s), bypass piping, backup plan and equipment, work schedule, monitoring log for bypass pumping, monitoring plan of the bypass pumping operation, and maintenance of traffic plan.

PART 2 - PRODUCTS

2.01 GENERAL

- A. The Contractor will provide and maintain adequate equipment, piping, tankers, and other necessary appurtenances in order to maintain continuous and reliable wastewater service in all wastewater lines as required for construction. The Contractor will have tankers, backup pump(s), piping, and appurtenances ready to deploy immediately.
- B. All piping will be designed to withstand at least twice the maximum system pressure or a minimum of 50-psi, whichever is greater.
- C. When bypassing a pump station, 1 back-up pump equal to the primary unit will be provided by the Contractor. Bypass pumps must comply with sound requirements.

PART 3 - EXECUTION

3.01 GENERAL

- A. The Contractor shall have all materials, equipment and labor necessary to complete the repair, replacement, or rehabilitation on the job site prior to isolating the gravity main segment, manhole, or pump station. The Contractor will demonstrate that the temporary bypass pumping system is in good working order and is sufficiently sized to successfully handle flows by performing a test run for a period of 24-hours prior to beginning the Work.

3.02 TRAFFIC CONSIDERATIONS

- A. The Contractor shall locate bypass pumping suction and discharge lines so as to not cause undue interference with the use of streets, private driveways, and alleys, to include the possible temporary trenching of piping at critical intersections. Additional traffic maintenance requirements are found in Section 01570 "Maintenance of Traffic".

3.03 BYPASS OPERATION

The County shall accept the bypass plan prior to implementation of the bypass operation. Contractor will plug off and pump down the sewer manhole or line segment in the immediate work area and will maintain the wastewater system so that surcharging does not occur. A successful 3-day test period shall be performed during normal County workdays (no weekend).

- A. Where Work requires the line to be blocked after normal working hours and bypass pumping is being used, the Contractor shall be responsible for monitoring the bypass operation 24-hours per day, 7-days per week. Any electronic monitoring in lieu of on-site monitoring must be detailed in the comprehensive written plan and approved by the County.
- B. The Contractor shall ensure that no damage will be caused to private property as a result of bypass pumping operations. The Contractor will complete the Work as quickly as possible and satisfactorily pass all tests, inspections, repair all deficiencies prior to discontinuing bypassing operations, and returning flow to the sewer manhole or line segment.
- C. During bypassing, no wastewater will be leaked, dumped, or spilled in or onto, any area outside of the existing wastewater system.
- D. The Contractor shall immediately notify the County should a sanitary sewer overflow occur and take the necessary action to clean up and disinfect the spillage to the satisfaction of the County or other governmental agency. If sewage is spilled onto public or private property, the Contractor will wash down, clean up and disinfect the spillage to the satisfaction of the County and or other governmental agencies.

- E. When bypassing a pump station, 1 back-up pump equal to the primary unit shall be required. Bypass pumps shall have a maximum rating of 55 decibels for sound attenuation.
- F. The Contractor shall cease bypass operations and return flows to the new and/or existing sewer when directed by the County. When bypass operations are complete, all bypass piping shall be drained into the wastewater system prior to disassembly.

3.04 CONTRACTOR LIABILITY

- A. The Contractor shall be responsible for all required pumping, equipment, piping, and appurtenances to accomplish the bypass and for any and all damage that results directly or indirectly from the bypass pumping equipment, piping and/or appurtenances. The Contractor shall also be liable for all County personnel labor and equipment costs, penalties and fines resulting from sanitary sewer overflows. It is the intent of these specifications to require the Contractor to establish adequate bypass pumping as required regardless of the flow condition.

END OF SECTION

1

THIS PAGE LEFT BLANK INTENTIONALLY

SECTION 01560
EROSION AND SEDIMENTATION CONTROL

PART 1 - GENERAL

1.01 WORK INCLUDED

- A. The Work specified in this Section consists of designing, providing, maintaining and removing temporary erosion and sedimentation controls as necessary to protect the Work and prevent sedimentation from the Contractor's activities from entering water bodies or enter other parts of the County's or other property owners sites outside the Construction limits.
- B. Temporary erosion controls include, but are not limited to; grassing, mulching, netting, watering and reseeded on-site surfaces and soil and borrow area surfaces, and providing interceptor ditches at end of berms and at those locations which will ensure that erosion during Construction will be either eliminated or maintained within acceptable limits as established by the regulatory agencies having jurisdiction.
- C. Temporary sedimentation controls include, but are not limited to; silt dams, traps, barriers, and appurtenances at the foot of sloped surfaces which will ensure that sedimentation pollution will be either eliminated or maintained within acceptable limits as established by the regulatory agencies having jurisdiction.

1.02 REQUIREMENTS

- A. The Contractor is responsible for providing effective temporary erosion and sediment control measures during Construction or until final controls become effective.
- B. The Contractor shall be responsible for filing Notice of Intent for Construction Activities with regulatory agencies (SJRWMD, SFWMD, and FDEP) as required by law, if thresholds are expected to be exceeded.
- C. The areas of unstabilized soil cover shall be minimized at all times to limit erosion and sedimentation.

1.03 SUBMITTALS:

- A. The Contractor shall prepare and submit an Erosion and Sedimentation Control Plan (Stormwater Pollution Prevention Plan) for County review and approval. The Plan shall be in effect throughout the Construction duration.

PART 2 - PRODUCTS

2.01 EROSION CONTROL

- A. Seed: Scarified Argentine Bahia.
- B. Sod: Bermuda grass, Argentine Bahia grass, Pensacola Bahia grass or St. Augustine. Grassing and Sodding Materials: As specified in Section 981 FDOT Specification for Road & Bridge Construction.
- C. Netting: Polypropylene mesh netting 5/8-inch x 3/4-inch (16 x 19mm) mesh with interwoven curlex fibers as manufactured by American Excelsior Company or equal. Netting: Fabricated of material in conformance with Section 985 FDOT Specification for Road & Bridge Construction.

2.02 SEDIMENTATION CONTROL

- A. Bales: Clean, synthetic hay type. Minimum dimensions of 14-inch by 18-inch by 36-inches at the time of placement.
- B. Netting: Fabricated of material in conformance with Section 985 FDOT Specification for Road & Bridge Construction.
- C. Sediment Control Fencing (Silt Fencing): As manufactured by American Excelsior Company or equal.
- D. Filter stone: Crushed stone conforming to Florida Department of Transportation Specifications.
- E. Concrete block: Hollow, non-load bearing type.
- F. Concrete: Exterior grade not less than 1-inch thick.
- G. Turbidity Barriers: Floating or staked as required.

PART 3 - EXECUTION

3.01 TEMPORARY EROSION CONTROL

- A. See Section 02578 "Solid Sodding."

3.02 SEDIMENTATION CONTROL

- A. Install and maintain silt fences and dams, traps, barriers, and appurtenances as shown on the approved descriptions and working Drawings. Replace deteriorated hay bales and dislodged filter stone. Repair portions of any devices damaged at no additional expense to the County.

- B. Install all sediment control devices in a timely manner to ensure the control of sediment. At sites where exposure to sensitive areas is likely, complete installation of all sediment control devices before starting earthwork.
- C. Use approved temporary erosion control features to correct conditions that develop during Construction that were not foreseen when the Erosion and Sedimentation Control Plan was first approved.

3.03 PERFORMANCE

- A. Should any of the temporary erosion and sediment control measures employed by the Contractor fail to produce results that comply with the requirements of the Regulatory agency having jurisdiction, the County or the Professional, the Contractor shall immediately take whatever steps necessary to correct the deficiency at its own expense to protect the Work and any adjacent property to the site, as well as to prevent contamination of any river, stream, lake, tidal waters, reservoir, canal or other water impoundments.
- B. The side slope areas with unstabilized or unprotected soil cover shall be minimized at all times to limit erosion and sedimentation.
- C. Incorporate permanent erosion control features into the Project at the earliest practical time.
- D. Remove temporary erosion and sedimentation controls when the Work is complete and in accordance with the Erosion and Sedimentation Control Plan (Stormwater Pollution Prevention Plan) and the Notice of Intent for Construction Activities filed with regulatory agencies.

3.04 MAINTENANCE OF EROSION AND CONTROL FEATURES

- A. Provide routine maintenance of permanent and temporary erosion control features, at no expense to the County, until the Project is complete and accepted.

END OF SECTION

1

THIS PAGE LEFT BLANK INTENTIONALLY

SECTION 01570
MAINTENANCE OF TRAFFIC

PART 1 - GENERAL

1.01 DESCRIPTION

This section includes identifying safety hazards and then furnishing all necessary labor, materials, tools, and equipment including, but not limited, to signs, barricades, traffic drums, cones, flashers, construction fencing, flag persons, warning devices, temporary pavement markings, delineators, etc., to control vehicular and pedestrian traffic through and adjacent to the project area. These measures and actions shall be taken to safely maintain the accessibility of public and construction traffic by preventing potential construction hazards. This Work shall also include all costs associated with the erecting, maintaining, moving, adjusting, cleaning, relocating, and storing the materials necessary to ensure safe movement of vehicular and pedestrian traffic throughout the project area. The Contractor may request that the County approve the detouring of traffic around the Construction area if it is in the best interest of public safety and the County. Detouring shall be limited to normal construction hours and two-way traffic patterns shall be re-established at the end of each workday.

1.02 REQUIREMENTS

- A. Traffic planning and control for the maintenance and protection of pedestrian and vehicular traffic affected by the Contractor's Work includes, but is not limited to:
 - 1. Construction and maintenance of any necessary detour equipment and facilities.
 - 2. Providing necessary facilities for access to residences and businesses.
 - 3. Furnishing, installing, and maintenance of traffic control and safety devices (e.g. signage, barricades, barriers, message boards, etc.), and flag persons as appropriate during Construction.
 - 4. Control of water runoff, dust and any other special requirements for safe and expeditious movement of traffic.
- B. Planning, maintenance and control of traffic shall be provided at the Contractor's expense. The Contractor will bear all expense of maintaining the vehicle and pedestrian traffic throughout the work area.
- C. The Contractor will ensure all personnel involved in traffic control are properly trained and capable of communicating with the public during closures and detours. The Contractor may be required to hire off-duty uniformed police officers, in addition to flag persons, to direct and maintain traffic on heavily traveled thoroughfares on which traffic is subject to delays or detours caused by the Contractor's operations. Locations and conditions requiring such uniformed police officers shall be as directed by the County.

- D. The Contractor will remove temporary equipment and facilities when no longer required, restore grounds to original, or to specified conditions.

1.03 SUBMITTALS

- A. Submit at Contractor's own expense a Traffic Control Plan for approval by the County. Sequence the Work in a manner that will minimize disruption of vehicular and pedestrian access through and around the construction area.
- B. The Traffic Control Plan will detail procedures and protective measures proposed by the Contractor to provide for protection and control of traffic affected by the Work consistent with the following applicable standards:
 - 1. Standard Specifications for Road and Bridge Construction, latest edition including all subsequent supplements issued by the Florida Department of Transportation, (FDOT Spec.).
 - 2. Manual of Traffic Control and Safe Practices for Street and Highway Construction, Maintenance and Utility Operations, FDOT.
 - 3. Right-of-Way Utilization Regulations, Orange County, Florida, latest edition.
- C. All references to the respective agencies in the above referenced standards shall be construed to also include the municipality as applicable for this Work.
- D. The Traffic Control Plan will be signed and sealed by a Professional Engineer registered in the state of Florida and shall include proposed locations and time durations of the following, as applicable:
 - 1. Pedestrian and public vehicular traffic routing.
 - 2. Lane and sidewalk closures, other traffic blockage and lane restrictions and reductions anticipated to be caused by construction operations. Show and describe the proposed location, dates, hours and duration of closure, vehicular and pedestrian traffic routing and management, traffic control devices for implementing pedestrian and vehicular movement around the closures, and details of barricades.
 - 3. Location, type and method of shoring to provide lateral support to the side of an excavation or embankment parallel to an open travel-way.
 - 4. Allowable on-street parking within the immediate vicinity of worksite.
 - 5. Access to buildings immediately adjacent to worksite.
 - 6. Driveways blocked by construction operations.
 - 7. Temporary traffic control devices, temporary pavement striping and marking of streets and sidewalks affected by construction
 - 8. Temporary commercial and industrial loading and unloading zones.
 - 9. Construction vehicle reroutes, travel times, staging locations, and number and size of vehicles involved.

- E. Obtain and submit prior to erection, or otherwise impacting traffic, all required permits from all authorities having jurisdiction, including Orange County Public Works, if applicable.

PART 2 - PRODUCTS

2.01 MATERIALS AND EQUIPMENT

- A. The Contractor will furnish barricades, warning signs, delineators, pilot cars and other traffic control materials and equipment in accordance with the Manual of Uniform Traffic Control Devices for Streets and Highways published by the United States Government Printing Office.

2.02 FLAG PERSONS

- A. All flag persons used on this Project will adhere to the following requirements:
 1. Any person acting as a flag person on this Project will have attended a training session taught by a Contractor's qualified trainer before the start date of this Contract.
 2. The Contractor's qualified trainer will have completed a "Flag person Train the Trainer Session" in the 5-years previous or before the start date of this Contract and will be on file as a qualified flag person trainer.
 3. The flag person trainer's name and Qualification Number will be furnished by the Contractor at the Pre-Construction meeting. The Contractor will provide all flag persons with the Flag Person Handbook and will observe the rules and regulations contained therein. This handbook will be in the possession of all flag person while flagging on the Project.
 4. Flag persons will not be assigned other duties while working as authorized flag persons.
 5. Any person replacing flag person for break shall have the same training.

PART 3 - EXECUTION

3.01 NOTIFICATIONS

- A. The Contractor will notify individual owners, owner's agents, and tenants of buildings adjacent to worksite in writing, with copies to the county, 72-hours in advance of any disruption to their access to those buildings and/or use of public ways adjacent to the buildings or prohibiting the stopping and parking of vehicles.
- B. Before closing any vehicle or pedestrian thoroughfare, the Contractor will give written notice to the County. Notice will be given no less than 72-hours in advance of the proposed closure, or as may be otherwise provided in the accepted Traffic Control Plan, so that the final approval of such closings can be obtained at least 48-hours in advance.

- C. The Contractor is responsible for notifying Fire and Ambulance Departments whenever roads are impassable.
- D. The Contractor will immediately notify the County of any vehicular or pedestrian safety or efficiency problems incurred as a result of the construction of the Project.

3.02 GENERAL TRAFFIC CONTROL

- A. The Contractor will sequence and plan construction operations and will generally conduct Work in such a manner as not to unduly or unnecessarily restrict or impede normal traffic.
- B. Unless otherwise provided, all roads within the limits of the Work will be kept open to all traffic by the Contractor. The Contractor will keep the portion of the project being used by public traffic, whether it is through or local traffic, in such condition that traffic will be adequately accommodated.
- C. The Contractor will be responsible for installation and maintenance of all traffic control devices and requirements for the duration of the construction period. Necessary precautions for traffic control will include, but not be limited to, warning signs, signals, lighting devices, markings, barricades, canalizations and hand signaling devices.
- D. The Contractor will provide and maintain in a safe condition temporary approaches or crossings and intersections with trails, roads, streets, businesses, parking lots, residences, garages and farms.
- E. The Contractor will provide emergency access to all residences and businesses at all times. Residential and business access will be restored and maintained at all times outside of the Contractor's normal working hours.
- F. Traffic is to be maintained on one section of existing pavement, proposed pavement, or a combination thereof. Alternating one-way traffic may be utilized and limited to a maximum length of 500-feet during construction hours. Lane width for alternating one-way traffic will be kept to a minimum width of 10-feet, or as directed by the County.
- G. Travel lanes and pedestrian passways will be drained and kept reasonably smooth, and in a suitable condition at all times in order to provide minimum interference to traffic consistent with the prosecution of the Work.
- H. The Contractor will make provisions at all "open cut" street crossings to allow for free passage of vehicles and pedestrians, either by bridging or other temporary crossing structures. Such structures will be of adequate strength and proper construction and will be maintained by the Contractor in such a manner as not to constitute an undue traffic hazard.

- I. The Contractor will keep all signs in proper position, clean, and legible at all times. Care will be taken so that weeds, shrubbery, construction materials, equipment, and soil are not allowed to obscure any sign, light, or barricade. Signs that do not apply to construction conditions should be removed or adjusted so that the legend is not visible to approaching traffic.
- J. The County may determine the need for, and extent of, additional striping removal and restriping.
- K. Excavated material, spoil banks, construction materials, equipment and supplies will not be located in such a manner as to obstruct traffic, as practicable. The Contractor will immediately remove from the site all demolition material, exercising such precaution as may be directed by the County. All material excavated shall be disposed of so as to minimize traffic and pedestrian inconvenience and to prevent damage to adjacent property.
- L. During any suspension, the Contractor will make passable and open to traffic such portions of the Project and/or temporally roadways as directed by the County for accommodation of traffic during the anticipated period of suspension. Passable conditions will be maintained until issuance of an order for the resumption of construction operations. When Work is resumed, the Contractor will replace or renew any Work or materials lost or damaged because of such temporary use in every respect as though its prosecution had been continuous and without interferences.

3.03 TEMPORARY SHORING

- A. Use shoring to maintain traffic when it is necessary to provide lateral support to the side of an excavation or embankment parallel to an open travel-way. Provide shoring when a theoretical 2:1 or steeper slope from the bottom of the excavation or embankment intersects the existing ground line closer than 5-feet (1.5 m) from the edge of pavement of the open travel-way.
- B. The Contractor will furnish, install, and remove sheeting, shoring, and bracing necessary to maintain traffic at locations shown on the Traffic Control Plan and other locations determined during construction.

END OF SECTION

THIS PAGE LEFT BLANK INTENTIONALLY

SECTION 01580
PROJECT IDENTIFICATION AND SIGNS

PART 1 - GENERAL

1.01 REQUIREMENTS INCLUDED

- A. The Contractor shall furnish, install, and maintain all sign materials including sign posts, weighted stands, brackets, any required mounting hardware, and miscellaneous materials required for temporary signs for the purpose of:
 - 1. Project Identification.
 - 2. Informational signs to direct traffic
 - 3. On-site safety signs as appropriate for the Work
- B. Remove temporary signs on completion of Construction prior to obtaining Certificate of Occupancy and Substantial Completion.
- C. Allow no other signs to be displayed without written approval of the County.

1.02 SUBMITTALS

- A. Submit complete Shop Drawings identifying locations, material, layout, sign content, font type and size, and sample colors. Make sign and lettering to scale, clearly indicating condensed lettering if used. The sign details will be submitted to the County for approval prior to fabrication.
- B. Submit method of erection to include materials, fasteners, and other items to assure compliance with the requirements for wind pressures as required by the authorities having jurisdiction.
- C. Submit signs in accordance with any details provided in the Drawings.
- D. Prior to erection obtain and submit all required permits from the authorities having jurisdiction.

1.03 PROJECT IDENTIFICATION SIGN

- A. Provide 1 painted sign at the site, or at each end of the Work if a linear project, or at each of the separate sites of Work, if applicable. The sign will be not less than 32-square feet area, with a minimum dimension of 4-feet and painted graphics with content to include:
 - 1. Title of Project
 - 2. Orange County Government name and logo
 - 3. Names and titles of the Board of County Commissioners, County Administrator, Director of Orange County Utilities Department, the Consulting Engineer, and the Contractor

- B. Erect on the site at a lighted location of high public visibility, adjacent to main entrance to site, as approved by the County. The sign must be located 5-feet from all rights-of-way and 20-feet from all property lines.

1.04 INFORMATIONAL SIGNS

- A. All signs and other traffic control devices shall conform to the requirements for shape, color, size, and location as specified in the latest Manual on Uniform Traffic Control and Safe Streets and Highways and the Florida Manual of Traffic Control and Safe Practices for Street and Highway Construction, Maintenance and Utility Operations. Information as to the above may be obtained from FDOT Division engineers.

PART 2 - PRODUCTS

2.01 SIGN MATERIALS

- A. Structure and Framing: New construction grade lumber, structurally adequate and suitable for exterior application and specified finish.
- B. Sign Panels: New A-B Grade, exterior type, APA DF plywood with inset hardwood edges and mitered corners, standard large sizes to minimize joints.
 - 1. Thickness: As required by standards to span framing members, to provide even, smooth surface without waves or buckles, minimum 3/4-inch.
- C. Rough Hardware: Galvanized steel, of sizes and types to enable sign assemblies to resist wind pressures as required by the authorities having jurisdiction but not less than a wind velocity of 50-mph.
 - 1. Use minimum 1/2-inch diameter button head carriage bolts to fasten sign panels to supporting structures. Bolt heads to be painted to match sign face.
- D. Paint: Exterior quality, as specified in Division 9 or as a minimum as specified herein.
 - 1. Primer and finish coat: exterior, semi-gloss, alkyd enamel.
 - 2. Colors for structure, framing, sign surfaces, and graphics: As shown on the Drawings or as selected by the County.
- E. Safety Sign Number Tags
 - 1. Removable aluminum or galvanized steel, with 4-inch high, blue numerals and steel tag hooks.

PART 3 - EXECUTION

3.01 PROJECT IDENTIFICATION SIGN

- A. Install project identification signs within 10-days of the Notice to Proceed date. Failure to erect the signs may be reason to delay approval of the initial Application for Payment.

- B. Paint exposed surfaces of supports, framing, and surface material; one (1) coat of primer and two (2) coats of finish paint.
- C. Set signs plumb and level and solidly brace as required to prevent displacement during the Construction period. If mounted on posts, sink posts 3-feet to 4-feet below grade, leaving a minimum of 8-feet of each post above grade for mounting the sign.
- D. Install informational signs at a height for optimum visibility, on ground mounted poles or attached to temporary structural surfaces.

3.02 MAINTENANCE

- A. Maintain signs and supports in a neat, clean condition; repair damages to structure, framing, or sign.
- B. Relocate informational signs as required by the progress of the Work.
- C. Poorly maintained, defaced, damaged, or dirty signs shall be replaced, repaired, or cleaned without delay.
- D. Special care must be taken to ensure that construction materials and dust are not allowed to obscure the face of a sign.
- E. Signs not in effect shall be covered or removed.

3.03 REMOVAL

- A. Remove signs, framing, supports, and foundations at Substantial Completion of the Work.
- B. Leave areas clean and patch as required to remove any traces of temporary signs.

END OF SECTION

1

THIS PAGE LEFT BLANK INTENTIONALLY

SECTION 01590
CONSTRUCTION FIELD OFFICE

PART 1 - GENERAL

1.01 SECTION INCLUDES

- A. Contractor provision of temporary utilities to include electricity, lighting, internet connectivity, heat, ventilation, telephone service, water, and sanitary facilities.
- B. Contractor provision of temporary controls to include barriers, enclosures and fencing, and water control.
- C. Contractor provision of temporary facilities to include access roads, parking, and temporary buildings.
- D. Contractor provision of field offices for the County.
- E. Restrictions on the use of existing adjacent facilities.

1.02 TEMPORARY ELECTRICITY

- A. Provide and pay for power service required for Construction and testing from local utility source.
- B. Provide temporary electric feeder from existing electrical service at location as directed by utility company. Power consumption will not disrupt the County's need for continuous service. Coordinate with the County before making taps or disturbing existing service.
- C. Provide separate metering and pay for cost of energy used until substantial completion. If electric service is turned over to and paid for by the County prior to substantial completion, reimburse the County for energy used up to substantial completion.
- D. Provide power outlets for Construction operations, with branch wiring and distribution boxes located as required. Provide OSHA approved flexible power cords as required.
- E. Contractor-installed permanent convenience receptacles may be used during Construction.

1.03 TEMPORARY LIGHTING

- A. Provide and maintain adequate lighting for Construction operations to achieve a minimum lighting level of one (1) watt/sq ft.
- B. Provide and maintain two (2) foot-candle lighting to exterior staging and storage areas after dark for security purposes.

- C. Provide and maintain 0.25-watt/sq ft H.I.D. lighting to interior Work areas after dark for security purposes.
- D. Provide branch wiring from power source to distribution boxes with lighting conductors, pigtails, and lamps as required.
- E. Maintain lighting and provide routine repairs.
- F. Permanent building lighting may be used during Construction.

1.04 TEMPORARY HEAT AND COOLING

- A. Provide and pay for heating and cooling as required to maintain specified conditions for Construction operations or as required for proper conduct of operations included in the Work.
- B. Prior to operation of permanent equipment for temporary purposes, verify that installation is approved for operation, equipment is lubricated and temporary filters are in place. Provide and pay for operation, maintenance, and regular replacement of filters and worn or consumed parts.
- C. Maintain minimum ambient temperature of 50°F and maximum relative humidity of 50% in areas where Construction is closed in and final finishes are to be placed, unless indicated otherwise in specifications.

1.05 TEMPORARY VENTILATION

- A. Ventilate enclosed areas to assist cure of materials, to dissipate humidity, and to prevent accumulation of dust, fumes, vapors, or gases.

1.06 TEMPORARY WATER SERVICE

- A. Provide, maintain, and pay for suitable quality water service required for Construction operations. Coordinate with the County if water supply is not separately metered. Pay all costs and expenses associated with such use.
- B. Extend branch piping with outlets located so water is available by hoses with threaded connections.

1.07 TEMPORARY SANITARY FACILITIES

- A. Provide and maintain required facilities and enclosures on-site. Maintain daily in clean and sanitary condition. Adjacent County office building toilet facilities are not to be used by Contractor.

1.08 BARRIERS

- A. Provide barriers to prevent unauthorized entry to Construction areas and to protect existing facilities and adjacent properties from damage from Construction operations.

- B. Provide barricades required by governing authorities for public rights-of-way.
- C. Provide protection for plant life designated to remain. Replace damaged plant life.
- D. Protect non-owned vehicular traffic, stored materials, site and structures from damage.

1.09 FENCING

- A. Unless directed otherwise in other sections of the Contract Documents, provide a 6-foot high fence completely around Construction site; provided with hinged vehicular and pedestrian gates with locks. Fencing will be galvanized, 2-inch mesh, chain link with solid top rail. Provide line posts and end posts as needed to maintain stretched and uniform fencing with no sags.
- B. Fencing plan will be approved by the County for each phase of the project. Submit fencing layout diagram prior to the Pre-Construction meeting.
- C. Provide visual fabric barrier at least 6-foot high on all fencing separating parking areas from Construction activities. Submit barrier fabric for approval before starting fencing. Barrier fabric will be capable of retaining physical integrity and color during the entire Construction period.

1.10 ACCESS ROADS

- A. Provide and maintain uninterrupted public access to existing buildings. Construction activities will not interfere with access. If Contractor fails to maintain public access after 2 written notices within a 24-hour period, the County reserves the right to correct such situation and back charge the Contractor.
- B. Construct and maintain temporary roads accessing public thoroughfares to serve Construction area.
- C. Extend and relocate access roads as Work progress requires. Provide detours necessary for unimpeded traffic flow.
- D. Provide and maintain access to fire hydrants, free of obstructions.
- E. Designated existing on-site roads may be used for Construction traffic. Repair or restore any damaged areas caused as a result of Construction activity. Such repair will be to a like-new condition.

1.11 PARKING

- A. Provide temporary surface parking areas to accommodate Construction personnel.
- B. Do not allow Construction vehicle parking on existing pavement unless approved by County.

1.12 FIELD OFFICES (FOR UTILITIES DEPARTMENT)

- A. Promptly after starting Work, the Contractor will provide and maintain 1 field office for the use of the County until Substantial Completion.
- B. The field offices will be an appropriate size required for the use of the County, as well as contain two offices and three desks. The field office structure will be a minimum of 10-feet x 40-feet. The layout of the County's field office will include adequate space to hold project meetings (minimum seating for 15).
- C. Installation of the field offices will meet all local codes and ordinances. The Contractor will as a minimum install the structures on a level, well-drained area. Structures will be designed and installed to resist 130-mph winds or applicable State of Florida code, whichever is more stringent.
- D. The field offices will be provided with structurally sound and safe steps and landings for each door. The doors will have secure locks. Construct appropriate walkway and landings. Construct covers over each door that extends 3-feet from the building and the full width of the landing.
- E. The field offices will be designated as a "No Smoking Area."
- F. The windows will be arranged for cross ventilation with screens.
- G. Provide air conditioning and heating systems with thermostat control.
- H. Provide electric power for the duration of the Work.
- I. The Contractor will provide the following with the field office, at a minimum:
 - 1. Electric lights (fifty (50) foot-candles at desktop height) and power supply outlets.
 - 2. When available, provide high-speed Internet access to all desks for the duration of the Work.
 - 3. Acceptable toilet facilities with appropriate signage that meet all of the local and State health codes and regulations.
 - 4. Fire extinguisher (Halon type, minimum 4 lb. capacity).
 - 5. Water coolers, bottled water and paper cups.
 - 6. Tables for viewing the Project Drawings.
 - 7. Standard office supplies.
 - 8. Weekly janitorial services.

1.13 SPECIFIC REQUIREMENTS FOR THE FIELD OFFICES

Provide the following for the exclusive use of the County: (Unless otherwise noted, the quantity should be sufficient for the duration of the Work.)

- A. Office Furnishings: The furniture will be delivered and placed as directed by the County.
- B. Desks: Flat top, double pedestal, with one box and one file drawer in each pedestal, 60-inches by 30-inches. Total quantity will be three (3).

- C. Chairs: Three (3) office-type chairs, adjustable heights, on rollers, with armrests.
- D. Conference Table and Chairs: One (1) table (3-feet by 8-feet minimum), scratch and stain resistant and 15 meeting-type chairs.
- E. Drawing Table: Two (2) plywood or standard drawing tables, 3-feet by 6-feet, with all required appurtenances and 2 extended height stools suitable for use at the drawing tables.
- F. Printer: One(1) - All in one color inkjet printer capable of printing, scanning and coping Ledger, Legal and Letter sizes. Standard interfaces shall include Hi-Speed USB 2.0, Wireless (802.11b/g/n), Ethernet. Minimum requirements include: 35 page automatic document feeder, printing 20 color copies per minute at 6000 x 1200 dpi resolution, scan resolution 2400 x 2400 dpi, flat bed document glass size Ledger (11" x 17") with standalone copy features, minimum of 250 sheet input capacity cassettes and 2 additional complete set of ink cartridges. Brother MFC-J6710DW or equal. Printers to be retained by the County.. All warranties, maintenance, servicing and sufficient appropriate ink/toner cartridges and paper for the duration of the Work.
- G. One (1) each refrigerator, microwave, coffee machine, and toaster oven.
 - 1. Provide Internet connection in each of the four offices in the field trailer. The connection shall be at least 5.0 Mbps of download speed or greater. Provide office with a wireless network 802.11 n with minimum of 8 concurrent users in addition to the network requirements. Wireless network shall allow additional portable computers to gain internet access within the office.
- H. File Cabinets, Storage, Bookcases:
 - 1. Three (3) Lateral Files: HON 600 Series, or equal, 42-inch wide, four-drawer.
 - 2. Two (2) steel vertical, hanging mobile plan stands, with approximately 12-hanging clamps. Provide all required clamps, of sufficient length to hold the Contract Drawings.
 - 3. Storage: Two (2) industrial grade steel cabinets, locking handles, 36-inches wide by 18-inches deep by 72-inches high.
 - 4. Bookcases: Three (3) HON metal bookcases, or equal, 34-1/2-inches wide by 12-5/8-inches deep by 71-inches high, color to be selected by the Engineer.
- I. Miscellaneous Field Supplies:
 - 1. One (1) minimum/maximum digital thermometer, with batteries for the duration of the Work.
 - 2. One (1) rain gauge.

1.14 REMOVAL OF TEMPORARY UTILITIES, FACILITIES, AND CONTROLS

- A. Remove all temporary utilities, equipment, facilities, and materials prior to submitting Final Application for Payment.
- B. Remove temporary underground installations to minimum depth of 2-feet and re-grade site.
- C. Clean and repair damage caused by installation or use of temporary Work.

- D. Restore any existing facilities used during Construction to original condition, unless otherwise directed in other sections of Contract Documents. Restore existing landscaping, drainage, paving, etc. to an "as-was" condition, unless otherwise directed in other sections of Contract Documents.

PART 2 - PRODUCTS (NOT USED)

PART 3 - EXECUTION (NOT USED)

END OF SECTION

SECTION 01610
DELIVERY, STORAGE AND HANDLING

PART 1 - GENERAL

1.01 DESCRIPTION

- A. This Section specifies the general requirements for the delivery, handling, storage and protection for all items required in the construction of the Work.
- B. Deliver, handle and store products in accordance with manufacturer's recommendations and by methods and means that will prevent damage, deterioration, and loss including theft and protect against damage from climatic conditions. Control delivery schedules to minimize long-term storage of products at the site and overcrowding of construction spaces. In particular, provide delivery/installation coordination to ensure minimum holding or storage times for products recognized to be flammable, hazardous, easily damaged, or sensitive to deterioration, theft and other sources of loss. Damaged or defective items, in the opinion of the County, will be replaced at no cost to the County.

1.02 REQUIREMENTS

- A. The Contractor is responsible for all material, equipment and supplies sold and delivered to the County under this Contract until final inspection of the Work and acceptance thereof by the County.
- B. All materials and equipment to be incorporated in the Work will be handled and stored by the Contractor before, during and after shipment in a manner to prevent warping, twisting, bending, breaking, chipping, rusting, and any injury, theft or damage of any kind whatsoever to the material or equipment.
- C. All materials and equipment, which in the opinion of the County, have become so damaged as to be unfit for the use intended or specified, will be promptly removed from the site of the Work, and the Contractor will receive no compensation for the damaged materials or equipment or for its removal.
- D. In the event any such material, equipment and supplies are lost, stolen, damaged or destroyed prior to final inspection and acceptance, the Contractor will replace same without additional cost to the County.

1.03 DELIVERY

- A. Transport and handle items in accordance with manufacturer's instructions.

- B. The County and the Contractor's project superintendent must be on-site to accept all deliveries shipped directly to the job site. If the project superintendent is not present for a delivery, that delivery may be rejected by the County. If any delivery is rejected due to non-availability of the Contractor's project superintendent, delivery shall be rescheduled at no additional cost to the County.
- C. Schedule delivery to reduce long-term on-site storage prior to installation and/or operation. Under no circumstances will materials or equipment be delivered to the site more than 1-month prior to installation without written authorization from the County.
- D. Coordinate deliveries in order to avoid delay in, or impediment of, the progress of the Work.
- E. Schedule deliveries to the site not more than 1-month prior to scheduled installation without written authorization from the County.
- F. Coordinate delivery with installation to ensure minimum holding time for items that are hazardous, flammable, easily damaged or sensitive to deterioration.
- G. All items delivered to the site will be unloaded and placed in a manner that will not hamper the Contractor's normal construction operation or those of Subcontractors and other Contractors and will not interfere with the flow of necessary traffic.
- H. Deliver products in undamaged condition, in manufacturer's original containers or packaging, with identifying labels intact and legible. Maintain packaged materials with seals unbroken and labels intact until time of use.
- I. Immediately on delivery, inspect shipments with the County to ensure compliance with requirements of Contract Documents and accepted submittals, and that products are properly protected and undamaged. If the Contractor does not notify the County regarding the delivery and the County rejects any part of the delivery, there will be no additional cost to the County for the material to be returned. For items furnished by others (i.e. County), perform inspection in the presence of the County. Provide written notification to the County of any problems.
- J. Promptly remove damaged material and unsuitable items from the job site, and promptly replace with material meeting the specified requirements, at no additional cost to the County.

1.04 STORAGE AND HANDLING

- A. Provide equipment and personnel to handle products by methods recommended by the manufacturer to prevent soiling or damage to products or packaging, with seals and labels intact and legible.
- B. The Contractor is responsible for securing a location for on-site storage of all material and equipment necessary for completion of the Work. The location and storage layout will be submitted to the County at the Pre-Construction conference.

- C. Manufacturer's storage instructions will be carefully studied by the Contractor and reviewed with the County. These instructions will be carefully followed and a written record of this kept by the Contractor.
- D. All material delivered to the job site will be protected from dirt, dust, dampness, water, and any other condition detrimental to the life of the material from the date of delivery to the time of installation of the material and acceptance by the County.
- E. When required or recommended by the manufacturer, the Contractor will furnish a covered, weather protected storage structure providing a clean, dry, non-corrosive environment for all mechanical equipment valves, architectural items, electrical and instrumentation equipment, and special equipment to be incorporated into this Project.
- F. Arrange storage in a manner to provide easy access for inspection. Make periodic inspections of stored products to assure that products are maintained under specified conditions and free from damage or deterioration.
- G. Should the Contractor fail to take proper action on storage and handling of equipment supplied under this Contract within 7-days after written notice to do so has been given, the County retains the right to correct all deficiencies noted in previously transmitted written notice and deduct the cost associated with these corrections from the Contract Amount. These costs may be comprised of expenditures for labor, equipment usage, administrative, clerical, engineering, and any other costs associated with making the necessary corrections.

1.05 SPECIFIC STORAGE AND HANDLING

(Additional specific storage and handling requirements may be found in the specification sections addressing the material requirements.)

- A. All mechanical and electrical equipment and instruments subject to corrosive damage by the atmosphere if stored outdoors (even though covered by canvas) will be stored in a weather tight building to prevent damage. The building may be a temporary structure on the site or elsewhere, but it must be satisfactory to the County. The building will be provided with adequate ventilation to prevent condensation. Maintain temperature and humidity within range required by manufacturer.
 - 1. All equipment will be stored fully lubricated with oil, grease and other lubricants unless otherwise instructed by the manufacturer. Mechanical equipment to be used in the Work, if stored for longer than 90-days, will have the bearings cleaned, flushed and lubricated prior to testing and startup, at no extra cost to the County.
 - 2. Moving parts will be rotated a minimum of once weekly to ensure proper lubrication and to avoid metal-to-metal "welding." Upon installation of the equipment, the Contractor will start the equipment, at least half load, once weekly for an adequate period of time to ensure that the equipment does not deteriorate from lack of use.

3. Lubricants will be changed upon completion of installation and as frequently as required thereafter during the period between installation and acceptance. New lubricants will be put into the equipment at the time of acceptance. Prior to acceptance of the equipment, the Contractor will have the manufacturer inspect the equipment and certify that its condition has not been detrimentally affected by the long storage period. Such certifications by the manufacturer will be deemed to mean that the equipment is judged by the manufacturer to be in a condition equal to that of equipment that has been shipped, installed, tested and accepted in a minimum time period. As such, the manufacturer will guaranty the equipment equally in both instances. If such a certification is not given, the equipment will be judged to be defective. It will be removed and replaced at the Contractor's expense.
 4. Electric motors provided with heaters will be temporarily wired for continuous heating during storage. Upon installation of the equipment, the Contractor will start the equipment, at least half load, and once weekly for an adequate period of time to insure that the equipment does not deteriorate from lack of use.
- B. Store loose granular materials on solid flat surfaces in a well-drained area. Prevent mixing with foreign matter.
 - C. Cement and lime will be stored under a roof and off the ground and will be kept completely dry at all times.
 - D. Brick, block and similar masonry products will be handled and stored in a manner to minimize breakage, chipping, cracking and spilling to a minimum.
 - E. Precast Concrete will be handled and stored in a manner to prevent accumulations of dirt, standing water, staining, chipping or cracking.
 - F. All structural and miscellaneous steel and reinforcing steel will be stored off the ground or otherwise to prevent accumulations of dirt or grease, and in a position to prevent accumulations of standing water and to minimize rusting. Beams will be stored with the webs vertical.
 - G. Metals will be stored dry, all under cover and vented to prevent build-up of humidity, all off ground to provide air circulation.
 - H. Lumber will be stacked to provide air circulation. Store materials for which maximum moisture content is specified in an area where moisture content can be maintained.
 - I. Gypsum wallboard systems will be stored to protect all metal studs, furring, insulation boards, batts, accessories and gypsum board to prevent any type of damage to these materials. Rusted material components, damp or wet insulation or gypsum boards will not be accepted.

- J. Acoustical materials will be delivered to the job site in unbroken containers labeled and clearly marked. Materials will not be removed from containers until ready to install, but will be stored in dry area with cartons neatly stacked. Before installation, acoustical board will be stored for not less than 24-hours in the Work area at the same temperature and relative humidity.
- K. Linear items will be stored in dry area with spacers to provide ventilation. Stack linear items to prevent warping, complying with manufacturer's instructions.
- L. Paints and other volatile materials will be stored within approved safety containers. No glass jugs will be permitted. Storage areas will be equipped with not less than 2 fire extinguishers (CO2 type) sufficient to discharge a distance of 25-feet when fully charged and have current tags. No other building materials will be stored in this area. Used rags will be removed daily. Clean rags will be stored in metal closed containers.

PART 2 - PRODUCTS (NOT USED)

PART 3 - EXECUTION (NOT USED)

END OF SECTION

1

THIS PAGE LEFT BLANK INTENTIONALLY

SECTION 01650
PUMP STATION START-UP AND TESTING

PART 1 - GENERAL

1.01 SCOPE OF WORK

- A. The Contractor will conduct preliminary testing of pump station facilities, products and equipment. If the preliminary field tests disclose any items furnished under this Contract which do not comply with the requirements of the Contract Documents, the Contractor shall make all changes, adjustments and replacements required prior to Start-up Demonstration and Acceptance Testing.
- B. The Contractor shall arrange qualified instruction by the manufacturer's representative for the County's designated operating and maintenance personnel in operation, adjustment and maintenance of products, equipment and systems.
- C. The Contractor shall furnish all labor, fuel, energy, lubrication, water, and all other materials, equipment, tools and instruments necessary for the Start-up Demonstration and Acceptance Testing unless otherwise specified.
- D. The startup and final check out shall demonstrate and ensure to the County the complete operating pump station system. The Contractor shall provide documentation certifying proper installation, testing and operation of all prescribed equipment and systems.

PART 2 - PRODUCTS (NOT USED)

PART 3 - EXECUTION

3.01 PUMP STATION START-UP TESTING AND INSPECTION

- A. The Contractor shall notify the County at least 10 normal working days prior to start-up.
- B. The following shall have been successfully met prior to pump station start-up:
 - 1. A walk through letter of acceptance received
 - 2. All wire checks conducted
 - 3. Video of gravity main inspections completed
 - 4. FDEP Clearances received
 - 5. FDEP placard for fuel tank if applicable
 - 6. Completed Appendix B "Pump Station Start-Up" form
 - 7. Certified Boundary Survey and As-Built Survey
 - 8. The Contractor shall conduct preliminary testing of equipment prior to start-up testing and make all changes, adjustments and replacements required; and

9. The liner(s) shall meet the testing requirements of the Contract Documents and a letter or form signed by the County that testing was witnessed and approved.
- C. The intent of the start-up testing is for the Contractor to demonstrate to the County that the Work will function as a complete and operable system under normal as well as emergency operating conditions and the pump station is ready for acceptance.
- D. The Contractor shall furnish all labor, fuel, energy, lubrication, water and all other materials, equipment, tools, and instruments necessary for pump station start-up testing and inspection. All material used shall be listed on the Appendix D "List of Approved Products." All required certification letters, spare parts and supplies shall be provided to the County. Listed below is a partial checklist of requirements to be met.
1. The Contractor shall coordinate startup activities with the County, the manufacturer's representatives and Subcontractors. A factory representative knowledgeable in the mechanical and electrical equipment furnished shall inspect and supervise a start-up of their respective equipment. A minimum of 1 full business day shall be provided for the testing. Additional time may be necessary due to faulty or incomplete Work. Upon satisfactory completion of the equipment testing and inspection, the factory representative(s) shall issue the required manufacturer's warranty certificates.
 2. Initiate start-up of each system in accordance with the operation and maintenance manual. Demonstrate that all of the components of a system are operating under their own controls as designated without overheating or overloading any parts and without objectionable vibration as determined by the County.
 3. Observe the system operation and make adjustments as necessary to optimize the system performance. Coordinate with County for any adjustments desired or operational problems requiring debugging.
 4. All functions of the pump station mechanical and electrical equipment shall be tested and inspected for operation and workmanship. All equipment shall be properly installed and meet the design performance requirements.
 5. The pumps shall be flow tested at the pump station start-up to verify their performance meets the design requirements and the manufacturer's pump curve.
 6. Furnish 2 printed copies and 3 electronic copies in Acrobat "pdf" format of the Operation and Maintenance Manual for the pump station to the County.
 7. A pump station start-up report shall be completed. See Appendix B "Pump Station Start-Up Report Form."
 8. The Contractor shall bear the entire expense of rectifying Work installed.
 9. The Contractor shall furnish the County with a written certification signed by the Manufacturer's representative that the equipment has been properly installed and lubricated, is in accurate alignment, is free from undue stress imposed by piping or mounting bolts, and has been operated under full load conditions and that satisfactory operation has been obtained.

E. Re-testing

If the start-up testing does not meet the requirements, the deficiencies shall be corrected and the testing procedure will be rescheduled again.

F. FDEP fuel tank placard

When a generator fuel tank is required, the Contractor shall submit documentation that the facility has passed the FDEP fuel tank compliance inspection and that a properly completed "Storage Tank Facility Registration Form" has been submitted to the Florida Departmental of Environmental Protection including all applicable fees. The placard shall be provided to the County.

G. Acceptance

1. The pump station shall be accepted based on the pump station functioning as a complete and operable system under normal as well as emergency operating conditions, the approved construction documents have been met and any deficiencies that were observed and noted have been corrected.
2. The Contractor shall ensure all fuel, lubrication, and all other materials for operation are replenished.

END OF SECTION

1

THIS PAGE LEFT BLANK INTENTIONALLY

SECTION 01700
PROJECT CLOSEOUT

PART 1 - GENERAL

1.01 DESCRIPTION

The term "Project Closeout" is defined to include requirements near the end of the Contract Time, in preparation for Substantial Completion acceptance, occupancy by the County, release of retainage, final acceptance, final payment, and similar actions evidencing completion of the Work. Time of closeout is directly related to "Substantial Completion"; therefore, the time of closeout may be either a single period for the entire Work or a series of time periods for individual elements of Work that has been certified as substantially complete at different dates. This time variation, if any, will be applicable to the other provisions of this section.

1.02 SCOPE OF WORK

- A. This Section specifies administrative and procedural requirements for project closeout, including but not limited to:
 - 1. Final Cleaning
 - 2. Substantial Completion
 - 3. Final Acceptance

1.03 RELATED WORK

- A. Drawings and general provisions of the Contract, including General and Supplementary Conditions and other Division 1 Specification Sections, apply to this Section.
- B. Closeout requirements for specific construction activities are included in the appropriate Sections in Divisions 2 through 16.
- C. Section 01720 "Project Record Documents"
- D. Section 01740 "Warranties and Bonds"

1.04 PREREQUISITES FOR SUBSTANTIAL COMPLETION.

When the Contractor considers the Work as substantially complete, submit to the County a written notice stating so and requesting an inspection to determine the status of completion. The Contractor will attach to the notice a list of items known to be incomplete or yet to be corrected. Complete the following before requesting the County's inspection for certification of substantial completion.

- A. In the progress payment request that coincides with or is the first request following, the date substantial completion is claimed, show 100% completion or list incomplete items, the value of incomplete Work, and reasons for the Work being incomplete. Inspection procedures include supporting documentation for completion as indicated in these Contract Documents.
- B. Submit a statement showing an accounting of changes to the Contract Sum.
- C. Submit specific warranties, workmanship/maintenance bonds, maintenance agreements, final certifications and similar documents in accordance with Section 01740 "Warranties and Bonds."
- D. Obtain and submit lien releases enabling the County's full, unrestricted use of the Work and access to services and utilities.
- E. Consult with County before submitting Record Documents in accordance with Section 01720 "Project Record Documents."
- F. Submit Operation and Maintenance Manuals.
- G. Make final changeover of permanent locks. Submit keys and keying schedule.
- H. Deliver tools, spare parts, extra stock, and similar items.
- I. Complete final cleaning requirements necessary for Substantial Completion.

1.05 FINAL CLEANING.

Complete the following cleaning operations prior to Substantial Completion or Owner occupancy.

- A. Remove from job site all tools, surplus materials, construction equipment, storage sheds, debris, waste and temporary services.
- B. Clean the site, including landscape development areas, of rubbish, litter and other foreign substances. Sweep paved areas broom clean; remove stains, spills and other foreign deposits. Rake grounds that are neither paved nor planted, to a smooth even-textured surface.
- C. Structures:
 - 1. Visually inspect exterior surfaces and remove all traces of soil, waste materials, smudges and other foreign matter.
 - 2. Remove all traces of splashed materials from adjacent surfaces.
 - 3. Ensure exterior surfaces have a uniform degree of cleanliness.
 - 4. Visually inspect interior surfaces and remove all traces of soil, waste materials, smudges and other foreign matter.
 - 5. Remove paint droppings, spots, stains and dirt from finished surfaces.
 - 6. Remove labels that are not permanent labels.
 - 7. Clean transparent materials, including mirrors and glass in doors and windows. Remove glazing compound and other substances that are noticeable vision-obscuring materials. Replace chipped or broken glass and other damaged transparent materials.

8. Clean exposed exterior and interior hard-surfaced finishes to a dust-free condition, free of stains, films and similar foreign substances. Leave concrete floors broom clean.
9. Wipe surface of mechanical and electrical equipment. Remove excess lubrication and other substances. Clean light fixtures and lamps.
10. Clean permanent filters of ventilating systems and replace disposable filters if units were operated during construction. Clean ducts, blowers and coils if units were operated without filters during construction.

1.06 OPERATION AND MAINTENANCE MANUALS

- A. The Contractor will submit the proposed format, content and tab structure for all Operating and Maintenance Manuals for the County's review and approval. The tab structure for Operating and Maintenance Manuals will follow specification division format as accepted by the Construction Specification Institute. After the County approves the proposed format, content, and tab structure for the Operating and Maintenance Manuals, the Contractor will create and deliver 5 complete sets.
- B. Operation and Maintenance documentation is required for each piece of mechanical, electrical, communications, instrumentation and controls, pneumatic, hydraulic, conveyance, and special construction. If required by the technical specifications, provide Operation and Maintenance documentation for any other product not listed in the foregoing.
- C. The requirements of this Section are separate, distinct and in addition to product submittal requirements that may be established by other Sections of the Specifications. Owner's manuals, manufacturer's printed instructions, parts lists, test data and other submittals required by other Sections of the Specifications may be included in the Operating and Maintenance Manuals provided that they are approved and are formatted in a manner consistent with the requirements of this Section.
- D. Deliver Operation and Maintenance Manuals directly to the County.
- E. Operating and Maintenance Manual documents must include, but are not limited to, table of contents, approved submittals, manufacturer's operating and maintenance instructions, brochures, Shop Drawings, performance curves and data sheets annotated to indicate equipment actually furnished (e.g. identifying impeller size, model, horsepower, etc), procedures, wiring and control diagrams, records of factory and field tests and device/controller settings and calibration, program lists or data compact discs, maintenance and warranty terms and contact information, spare parts listings, inspection procedures, emergency instructions, and other Operating and Maintenance documentation that may be useful to the County. The material and equipment data required by this Section must include all data necessary for the proper installation, removal, normal operation, emergency operation, startup, shutdown, maintenance, cleaning, adjustment, calibration, lubrication, assembly, disassembly, repair, inspection, trouble-shooting, and warranty service of the equipment or materials.

- F. The Contractor must bind the Operating and Maintenance Manual documents in heavy-duty, 3-ring vinyl-covered binders including pocket folders for folded sheet information. Mark binder identification on both the front and spine of each binder. Binder information must list the project title, identify separate structures or locations as applicable, identify the general subject matter covered in the manual and must include the words "OPERATING AND MAINTENANCE INSTRUCTIONS".
 - 1. The Contractor must submit the Operating and Maintenance documents on three-hole punched, 8-1/2-inch x 11-inch sheets or on three-hole punched sheets that are foldable in multiples of 8-1/2-inch x 11-inch. The three-hole punched edge will be the left 11-inch edge.
 - 2. The Contractor may request waivers to the size requirement for specific instances. The Contractor's waiver request must be in writing to the County. The Contractor's waiver request must include a justification for seeking the waiver.

- G. The Contractor must provide an electronic version of the complete and final Operating and Maintenance Manuals in original electronic file format on compact disc or DVD. The Contractor must also provide one (1) electronic pdf file of each bound Operating and Maintenance Manual that represents each Manual's content. The electronic pdf file must match the Operating and Maintenance Manual content and organizational structure.

1.07 SUBSTANTIAL COMPLETION INSPECTION PROCEDURES

- A. Upon receipt of the Contractor's request for inspection, the County will either proceed with inspection or advise the Contractor of incomplete prerequisites.

- B. Following the initial inspection, the County will either prepare the certificate of Substantial Completion, or advise the Contractor of Work which must be performed before the certificate will be issued. The County will repeat the inspection when requested in writing and when assured that the Work has been substantially completed.

- C. Results of the completed inspection will form the initial "punch list" for final acceptance.

1.08 PREREQUISITES FOR FINAL ACCEPTANCE.

Complete the following before requesting the County's final inspection for certification of final acceptance, and final payment. List known exceptions, if any, in the request.

- A. Submit the final payment request with final releases and supporting documentation not previously submitted and accepted. Include certificates for insurance for products and completed operations where required.

- B. Submit written certification that:
 - 1. The County's final punch list of itemized Work to be completed or corrected, stating that each item has been completed or otherwise resolved for acceptance.
 - 2. The Contract Documents have been reviewed and Work has been completed in accordance with Contract Documents.

3. Equipment and systems have been tested in the presence of the County and are operational.
4. Work is completed and ready for final inspection.

C. Submit consent of surety.

D. Submit evidence of final, continuing insurance coverage complying with insurance requirements.

1.09 FINAL ACCEPTANCE INSPECTION PROCEDURES

A. The County will re-inspect the Work upon receipt of the Contractor's written notice that the Work, including punch list items resulting from earlier inspections, has been completed, except for those items for which completion has been delayed because of circumstances that are acceptable to the County.

B. Upon completion of re-inspection, the County will either prepare a certificate of final acceptance or advise the Contractor of Work that is incomplete or of obligations that have not been fulfilled, which are required for final acceptance.

C. If necessary, the re-inspection procedure will be repeated.

PART 2 - PRODUCTS (NOT USED)

PART 3 - EXECUTION (NOT USED)

END OF SECTION

1

THIS PAGE LEFT BLANK INTENTIONALLY

SECTION 01720
PROJECT RECORD DOCUMENTS

PART 1 - GENERAL

1.01 DESCRIPTION

- A. The purpose of the Project Record Documents is to provide the County with factual information regarding all aspects of the Work, both concealed and visible, to enable future location, identification and modification of the Work without lengthy and expensive site measurement, investigation or examination.
- B. These standards and procedures are for integration of digital engineering CAD drawings and attribute data into the database environments, while maintaining the integrity and positional accuracy of the data. The requirement for digital submittal of approved construction plans is to provide the County GIS with a parcel and utility base for field maintenance and operations.
- C. The location of the constructed improvements as depicted in the Contract Drawings is required. To insure the Work was constructed in conformance with the Contract Drawings, the following survey documents are required to be prepared and certified by the Surveyor:
 - 1. As-Built Asset Attribute Data Table (see Table 01050-2)
 - 2. Pipe Deflection Table (see Table 01050-3)
 - 3. Gravity Main Table (see Table 01050-4)
 - 4. Boundary Survey and Survey Map Report for pump stations and easements with constructed improvements.

1.02 DEFINITIONS

Except where specific definitions are used within a specific section, the following terms, phrases, words and their derivation shall have the meaning given herein when consistent with the context in which they are used. Words used in the present tense include the future tense, words in the plural number include the singular number and words in the singular number include the plural number.

- A. As-Built Drawings: Drawings prepared by the Contractor's Surveyor shall depict the actual location of installed utilities for the completed Work in a full size hard copy and an electronic AutoCAD file (dwg) format.
- B. Record Documents: All documents as required in subsections 1.04 and 2.02 in this specification section.
- C. Boundary Survey: Boundary survey, map and report certified by a Surveyor shall be provided that meets the requirements of Chapter 5J-17 'Minimum Technical Standards', FAC.

- D. Surveyor: Contractor's Surveyor that is licensed by the State of Florida as a Professional Surveyor and Mapper pursuant to Chapter 472, F.S.
- E. Survey Map Report: As a minimum the Survey Map Report shall identify any corners that had to be reset, measurements and computations made, pump station and easement boundary issues, locations of constructed improvements outside boundaries, and accuracies obtained.

1.03 QUALITY ASSURANCE

- A. Delegate the responsibility for maintenance of the Record Documents to one person on the Contractor's staff as approved by the County.
- B. Thoroughly coordinate changes within the Record Documents, making adequate and proper entries on each page of specifications and each sheet of Drawings and other documents where such entry is required to show progress and changes properly.
- C. Make entries within 24-hours after receipt of information has occurred.

1.04 RECORD DOCUMENTS AT SITE

- A. Maintain at the site and always available for County's use one (1) record copy of:
 - 1. Construction Contract, Drawings, Specifications, General Conditions, Supplemental Conditions, Bid Proposal, Instruction to Bidders, Addenda, and all other Contract Documents
 - 2. Change Orders, Verbal Orders, and other modifications to Contract
 - 3. Written instructions by the County as well as correspondence related to Requests for Information (RFIs)
 - 4. Accepted Shop Drawings, Samples, product data, substitution and "or-equal" requests
 - 5. Field test records, inspection certificates, manufacturer certificates and construction photographs
 - 6. Progressive As-Built Drawings
 - 7. Current Surveyor's tables for the As-Built Assets Attribute Data, Pipe Deflection Data, and Gravity Main Data
- B. Maintain the documents in an organized, clean, dry, legible condition and completely protected from deterioration and from loss and damage until completion of the Work, transfer of all record data to the final As-built Drawings for submittal to the County.
- C. Store As-Built Documents and samples in Contractor's office apart from documents used for construction. Do not use As-Built document for construction purposes. Label each document "AS-BUILT" in neat large printed letters. File documents and samples in accordance with CSI/CSC format.
- D. Record information concurrently with construction progress. Do not conceal any Work until required information is recorded.

PART 2 - PRODUCTS

2.01 AS-BUILT DRAWINGS

- A. Maintain the electronic As-Built Drawings to accurately record progress of Work and change orders throughout the duration of the Contract.
- B. Date all entries. Enter RFI No., Change Order No., etc. when applicable.
- C. Call attention to the entry by highlighting with a "cloud" drawn around the area affected.
- D. In the event of overlapping changes, use different colors for entries of the overlapping changes.
- E. Design call-outs shall have a thin strike line through the design call-out and all As-Built information must be labeled (or abbreviated "AB") and be shown in a bolder text that is completely legible.
- F. Make entries in the pertinent other documents while coordinating with the County for validity.
- G. Entries shall consist of graphical representations, plan view and profiles, written comments, dimensions, State Plane Coordinates, details and any other information as required to document field and other changes of the actual Work completed. As a minimum, make entries to also record:
 - 1. Depths of various elements of foundation in relation to finish floor datum and State Plane Coordinates and elevations.
 - 2. As-Built Asset Attribute Data Table shall be completed in the Drawings.
 - 3. When electrical boxes, or underground conduits and plumbing are involved as part of the Work, record true elevations and locations, dimensions between boxes.
 - 4. Actually installed pipe or other work materials, class, pressure-rating, diameter, size, specifications, etc. Similar information for other encountered underground utilities, not installed by Contractor, their owner and actual location if different than shown in the Contract Documents.
 - 5. Details, not on original Contract Drawings, as needed to show the actual location of the Work completed in a manner that allows the County to find it in the future.
 - 6. The Contractor shall mark all arrangements of conduits, circuits, piping, ducts and similar items shown schematically on the construction documents and show on the As-Built Drawings the actual horizontal and vertical alignments and locations.
 - 7. Major architectural and structural changes including relocation of doors, windows, etc. Architectural schedule changes according to Contractor's records and Shop Drawings.

2.02 RECORD DOCUMENTS

- A. Three (3) hard copy sets and three (3) digital media sets of the final Record Documents and shall include all of the documents described below under this subsection 2.02.

- B. The following documents shall be signed and sealed by the Surveyor:
1. As-Built Asset Attribute Data Table (see Specification Section 01050 "Surveying and Field Engineering," Table 01050-2 for an example)
 2. Boundary Survey of pump station and Survey Map Report
 3. Boundary Survey and Survey Map Report for the location of constructed pipes within any easements and right-of-way. As a minimum the Survey Map Report shall identify or describe the locations where the pipe centerline was constructed within 3-feet of the easement or right-of-way boundary, where the pipe was constructed outside the easement or right-of-way boundary, any corners that had to be reset, measurements and computations made, pump station boundary issues, and accuracies obtained. Survey map report shall be dated after the Work within the right-of-ways or easements have been completed.
 4. Gravity Main Table (see Specification Section 01050 "Surveying and Field Engineering", Table 01050-4 for an example)
 5. Pipe Deflection Table (see Specification Section 01050 "Surveying and Field Engineering" Table 01050-3 for an example). An electronic blank table will be supplied by the County.
- C. Digital sets of the final Record Documents including but not limited to:
1. Scanned digital copies of the final As-Built Drawings
 2. Electronic Survey documents electronically sealed by the Surveyor
 3. Final Record Documents information
 4. Digital As-Built Drawing in the Engineer's current version of AutoCAD file (dwg) format for the Contract Drawings, updated to match the final Record Drawing information
- D. Pump station site Boundary Survey and Map Report.
- E. New Boundary Survey to re-establish easement corners, right-of-way monuments, or pump station site corners with monuments if destroyed by the Work.
- F. Scanned Documents: Scan the Survey Documents and other Record Documents reflecting changes from the Bid Documents.
- G. The scanned "As-Built" Drawing sets shall be complete and include the title sheet, plan/profile sheets, cross-sections, and details. Each individual sheet contained in the printed set of the As-Built Drawings shall be included in the electronic drawings, with each sheet being converted into an individual tif (tagged image file). The plan sheets shall be scanned in tif format Group 4 at minimum of 400 dpi resolution to maintain legibility of each drawing. Then, the tif images shall be embedded into a single pdf (Adobe Acrobat) file representing the complete plan set. Review all Record Documents to ensure a complete record of the Project.

- H. Provide an encompassing digital AutoCAD file that includes all the information of the As-Built Drawings and any other graphical information in the As-Built Drawings. It shall include the overall Work, utility system layout and associated parcel boundaries and easements. Feature point, line and polygon information for new or altered Work and all accompanying geodetic control and survey data shall be included. The surveyor's certified As-Built Asset Attribute Data shall be added to the As-Built Drawings and Surveyor shall electronically seal the data in a comma-delineated ASCII format (txt).

PART 3 - EXECUTION

3.01 PRE-CONSTRUCTION MEETING

- A. Pre-construction Meeting: It is recommended that the Surveyor attend the Pre-construction meeting. At the pre-construction meeting the Contractor shall be provided with a blank electronic version of the spreadsheet for the tables: Asset Attribute Data and Pipe Deflection. The Contractor's surveyor shall use these tables to input the data and shall not alter the table format or formulas.

3.02 CONSTRUCTION PROGRESS MEETINGS

- A. Contractor shall provide progressive Record Documents described below:
1. Construction Contract, As-Built Drawings, Specifications, General Conditions, Supplemental Conditions, Bid Proposal, Instruction to Bidders, Addenda, and all other Contract Documents.
 2. Specifications and Addenda: Record manufacturer, trade name, catalog number and supplier of each product and item of equipment actually installed as well as any changes made by Field Order, Change Order or other.
 3. Change orders, verbal orders, and other modifications to Contract.
 4. Written instructions by the County as well as correspondence related to Requests for Information (RFIs).
 5. Accepted Shop Drawings, samples, product data, substitution and "or-equal" requests.
 6. Field test records, inspection certificates, manufacturer certificates and construction photographs.
 7. As-Built Asset Attribute Data Table: Surveyor shall obtain field measurements of vertical and horizontal dimensions of constructed improvements. The monthly submittal shall include the Surveyor's certified statement regarding the constructed improvements being within the specified accuracies as described in Specification Section 01050 "Surveying and Field Engineering", Table 01050-1 Minimum Survey Accuracies or if not, indicating the variances.
 8. Gravity Main Table: Surveyor shall prepare and update a Gravity Main Table to include as a minimum the pipe segment identification, pipe lengths, manhole inverts and tops, and slopes for gravity mains. Surveyor shall certify the data entered are correct and indicate if the minimum slopes have not been met.

9. Pipe Deflection Table: Surveyor shall input the type of pipe, pipe manufacturer, PVC manufacturer deflection allowance, allowable angle of offset and radius of curvature, laying length of pipe, and coordinates. Surveyor shall certify the data entered are correct and indicate if the deflection allowance, offset or radius of curvature exceeds the manufacturer's recommendations.

3.03 FINAL RECORD DOCUMENTS SUBMITTAL

- A. Submit the Final Record Documents within 20-days after Substantial Completion.
 1. Participate in review meetings as required and make required changes and promptly deliver the Final Record Documents to the County.

3.04 STORAGE AND PRESERVATION

- A. Store Record Documents and samples at a protected location in the project field office apart from documents used for construction.
 1. Provide files and racks for storage of documents
 2. Provide locked cabinet or secure space for storage of samples
- B. File documents and samples in accordance with CSI format with section numbers matching those in the Contract Documents.
- C. In the event of loss of recorded data, use means necessary to again secure the data to the County's approval.
 1. Such means shall include, if necessary in the opinion of the County, removal and replacement of concealing materials.
 2. In such cases, provide replacements of the concealing materials to the standards originally required by the Contract Documents.

END OF SECTION

SECTION 01730
PUMP STATION OPERATION AND MAINTENANCE MANUAL

PART 1 - GENERAL

1.01 REQUIREMENTS INCLUDED

- A. Section includes the submittal process for the operation and maintenance manual and the manual shall contain the technical information required for proper installation, operation and maintenance of process, electrical and mechanical equipment and systems.

1.02 SUBMITTAL SCHEDULE

- A. Operation and Maintenance Manual Schedule
 - 1. Initial submittal within 60-days after date Shop Drawings are approved.

1.03 PREPARATION OF SUBMITTALS

- A. General
 - 1. Materials are provided for County's use, reproduction and distribution as training and reference materials within County's organization.
 - 2. Applicable to hard copy or electronic media.
 - 3. Applicable to materials containing copyright notice as well as those with no copyright notice.
 - 4. Notify manufacturer of this intended use of materials provided under the Contract.
 - 5. Number each Operation and Maintenance Manual transmittal with the original root number of the associated Shop Drawing.
 - 6. Identify resubmittals with the original number plus a suffix letter starting with "A."
 - 7. Submittal format:
 - a. Interim submittals: Submit two (2) paper copies until manual is approved.
 - b. Final submittals:
 - (1) Within 30-days of receipt of approval, submit one (1) additional paper copy and two (2) electronic copies on Compact Disc (CD-ROM) in Portable Document Format (PDF).
 - 8. Compact discs to be secured in jewel cases.
 - 9. Electronic copies will be reviewed for conformance with the approved paper copy and the electronic copy (PDF) requirements of this Specification.
 - 10. Non-conforming CDs will be returned with comments.
 - 11. Provide final CDs within 30-days of receipt of comments.
 - 12. Paper copy submittals:
 - a. Submit Operation and Maintenance Manuals printed on 8-1/2 inch x 11 inch size heavy first quality paper with standard three-hole punching and bound in appropriately sized three-ring (or post) vinyl view binders with clear overlays front, spine and back.

- b. Provide binders with titles inserted under clear overlay on front and on spine of each binder.
 - c. As space allows, binder titles shall include, but not necessarily be limited to:
 - (1) Project Name
 - (2) Related Specification Number
 - (3) Equipment Name(s) and
 - (4) Project Equipment Tag Numbers
 - d. Provide a Cover Page for each manual with the following information:
 - (1) Manufacturer(s)
 - (2) Date
 - (3) Project Owner and Project Name
 - (4) Specification Section
 - (5) Project Equipment Tag Numbers
 - (6) Model Numbers
 - (7) Engineer
 - (8) Contractor
 - e. Provide a Table of Contents or Index for each manual.
 - f. Use plastic-coated dividers to tab each section of each manual per the manual's Table of Contents/Index for easy reference.
 - g. Provide plastic sheet lifters prior to first page and following last page.
 - h. Reduce Drawings or diagrams bound in manuals to an 8-1/2 inch x 11 inch or 11 inch x 17 inch size.
 - i. Where reduction is not practical to ensure readability, fold larger Drawings separately and place in vinyl envelopes which are bound into the binder.
 - j. Identify vinyl envelopes with Drawing numbers.
 - k. Mark each sheet to clearly identify specific products and component parts and data applicable to the installation for the Project.
 - l. Delete or cross out information that does not specifically apply to the Project.
- B. Electronic copy submittals:
- 1. Electronic copies of the approved paper copy Operation and Maintenance Manuals are to be produced in Adobe Acrobat's Portable Document Format (PDF) Version {5.0} or higher.
 - 2. Do *not* password protect and/or lock the PDF document.
 - 3. Drawings or other graphics must be converted to PDF format and made part of the PDF document.
 - 4. Scanning to be used only where actual file conversion is not possible.
 - 5. Rotate pages that must be viewed in landscape to the appropriate position for easy reading.
 - 6. Images only shall be scanned at a resolution of 300 dpi or greater.
 - 7. Perform Optical Character Recognition (OCR) capture on all images.
 - 8. Achieve OCR with the "original image with hidden text" option.
 - 9. Word searches of the PDF document must operate successfully to demonstrate OCR compliance.
 - 10. Create bookmarks in the navigation frame, for each entry in the Table of Contents/Index.

11. Normally three levels deep (i.e., "Chapter," "Section," "Sub-section").
12. Thumbnails must be generated for each PDF file.
13. Set the opening view for PDF files as follows:
 - a. Initial view: Bookmarks and Page.
 - b. Magnification: Fit in Window.
 - c. Page layout: Single page.
 - d. Set the file to open to the cover page of the manual with bookmarks to the left, and the first bookmark linked to the cover page.
 - e. All PDF documents shall be set with the option "Fast Web View" to open the first pages of the document for the viewer while the rest of the document continues to load.
14. File naming conventions
 - a. File names shall use a "ten dot three" convention (XXXXXX-YY-Z.PDF) where XXXXX is the Specification Section number, YY is the Shop Drawing Root number and Z is an ID number used to designate the associated volume.

Example 1:

Two (2) pumps submitted as separate Shop Drawings under the same Specification Section:

Pump 1 = 11061-01-1.pdf.

Pump 2 = 11061-02-1.pdf.

Example 2:

Control system submitted as one (1) Shop Drawing but separated into two (2) O&M volumes:

Volume 1 = 13440-01-1.pdf.

Volume 2 = 13440-01-2.pdf.

15. As a minimum, include the following labeling on all CD-ROM discs and jewel cases:
 - a. Project Name
 - b. Equipment Name and Project Tag Number
 - c. Project Specification Section
 - d. Manufacturer Name
 - e. Vendor Name
 - f. Binding
 - (1) Include labeled CD(s) in labeled jewel case(s).
 - (2) Bind jewel cases in standard three-ring binder Jewel Case Page(s), inserted at the front of the Final paper copy submittal.
 - (3) Jewel Case Page(s) to have means for securing Jewel Case(s) to prevent loss (e.g., flap and strap).

1.04 EQUIPMENT AND SYSTEMS

- A. Submission of Operation and Maintenance Manuals for equipment and systems is applicable but not necessarily limited to:
 1. Major equipment

2. Equipment powered by electrical, pneumatic or hydraulic systems
3. Specialized equipment and systems including instrumentation and control systems and system components for HVAC process system control
4. Valves and water control gates
5. Equipment function, normal operating characteristics, limiting operations
6. Assembly, disassembly, installation, alignment, adjustment, and checking instructions
7. Operating instructions for start-up, normal operation, control, shutdown, and emergency conditions
8. Lubrication and maintenance instructions
9. Troubleshooting guide
10. Parts lists
 - a. Comprehensive parts and parts price lists.
 - b. List of spare parts provided as specified in the associated Specification Section.
11. Outline, cross-section, and assembly Drawings; engineering data; and electrical diagrams, including elementary diagrams, wiring diagrams, connection diagrams, word description of wiring diagrams and interconnection diagrams.
12. Test data and performance curves.
13. As-constructed fabrication or layout Drawings and wiring diagrams.
14. Instrumentation or tag numbers assigned to the equipment by the Contract Documents are to be used to identify equipment and system components.
15. Additional information as specified in the associated equipment or system Specification Section.

1.05 COUNTY/PROFESSIONAL'S REVIEW ACTION

- A. County/Professional will review and indicate one of the following review actions:
 1. ACCEPTABLE
 2. REVISE AND RESUBMIT
- B. Acceptable paper copy submittals will be retained with the transmittal form returned with a request for one (1) additional paper copy and two (2) electronic copies on CD-ROM.
- C. Deficient submittals (paper copy and/or electronic copy) will be returned along with the transmittal form which will be marked to indicate deficient areas.

END OF SECTION

SECTION 01740
WARRANTIES AND BONDS

PART 1 - GENERAL

1.01 SCOPE OF WORK

- A. This Section specifies general administrative and procedural requirements for warranties and bonds required by the Contract Documents, including manufacturer's standard warranties on products and special warranties.

1.02 RELATED WORK

- A. Refer to Conditions of Contract for the general requirements relating to warranties and bonds.
- B. General closeout requirements are included in Section 01700 "Project Closeout."
- C. Specific requirements for warranties for the Work and products and installations that are specified to be warranted are included in the individual Sections of Division 2 through 16.

1.03 DEFINITIONS

- A. Standard Product Warranties are preprinted written warranties published by individual manufacturers for particular products and are specifically endorsed by the manufacturer to the County.
- B. Special Warranties are written warranties required by or incorporated in the Contract Documents, either to extend time limits provided by standard warranties or to provide greater rights for the County.

1.04 SUBMITTALS

- A. Submit written warranties to the County prior to requesting a Substantial Completion Inspection as outlined in Section 01700 "Project Closeout." If the Certificate of Substantial Completion designates a commencement date for warranties other than the date of Substantial Completion for the Work, or a designated portion of the Work, submit written warranties upon request of the County.
- B. When a designated portion of the Work is completed and occupied or used by the County, by separate agreement with the Contractor during the construction period, submit properly executed warranties to the County within 15-days of completion of that designated portion of the Work.

- C. When a special warranty is required to be executed by the Contractor, or the Contractor and a Subcontractor, supplier or manufacturer, prepare a written document that contains appropriate terms and identification, ready for execution by the required parties. Submit a draft to the County for approval prior to final execution.
- D. Refer to individual Sections of Divisions 2 through 16 for specific content requirements, and particular requirements for submittal of special warranties.
- E. Prior to Substantial Completion Inspection, submit to the County two (2) copies of each required warranty and bond properly executed by the Contractor, or by the Contractor, Subcontractor, supplier, or manufacturer. Organize the warranty documents into an orderly sequence based on the table of contents of the Project Manual.
 - 1. Bind warranties and bonds in heavy-duty, commercial quality, durable 3-ring vinyl covered loose-leaf binders, thickness as necessary to accommodate contents and sized to receive 8-1/2-inch by 11-inch three-hole punched paper.
 - 2. Table of Contents will be neatly typed, in the sequence of the Table of Contents of the Project Manual, with each item identified with the number and title of the specification Section in which specified and the name of the product or work item.
 - 3. Provide heavy paper dividers with celluloid covered tabs for each separate warranty. Mark the tab to identify the product or installation. Provide a typed description of the product or installation, including the name of the product and the name, address and telephone number of the installer, supplier and manufacturer.
 - 4. Identify each binder on the front and the spine with the typed or printed title "WARRANTIES AND BONDS", the project title or name and the name, address and telephone number of the Contractor.
 - 5. When operating and maintenance manuals are required for warranted construction, provide additional copies of each required warranty, as necessary, for inclusion in each required manual.

1.05 WARRANTY REQUIREMENT

- A. The Contractor will warrant all equipment in the Contractor's one-year warranty period even though certificates of warranty may not be required. For all major pieces of equipment, the Contractor shall submit a warranty from the equipment manufacturer. "Major" equipment is defined as a device having a 5 HP or larger motor or which lists for more than \$1,000.00.
- B. In the event that an equipment manufacturer or supplier is unwilling to provide a one-year warranty commencing at Substantial Completion, the Contractor will obtain from the manufacturer a warranty of sufficient length commencing at the time of equipment delivery to the job site, such that the warranty will extend to at least 1-year past substantial completion.
- C. If an individual specification section requires a particular warranty more stringent than that required by this Section or the General Conditions, the more stringent requirements will govern for the applicable portion of the Work.

- D. Related Damages and Losses: When correcting warranted Work that has failed, remove and replace other Work that has been damaged as a result of such failure or that must be removed and replaced to provide access for correction of warranted Work.
- E. Reinstatement of Warranty: When Work covered by a warranty has failed and been corrected by replacement or rebuilding, reinstate the warranty by written endorsement. The reinstated warranty will be equal to the original warranty with an equitable adjustment for depreciation.
- F. Replacement Cost: Upon determination that Work covered by a warranty has failed, replace or rebuild the Work to an acceptable condition complying with requirements of Contract Documents. The Contractor is responsible for the cost of replacing or rebuilding defective Work regardless of whether the County has benefited from use of the Work through a portion of its anticipated useful service life.
- G. County's Recourse: Written warranties made to the County are in addition to implied warranties, and will not limit the duties, obligations, rights and remedies otherwise available under the law, nor will warranty periods be interpreted as limitations on time in which the County can enforce such other duties, obligations, rights, or remedies.
- H. Rejection of Warranties: The County reserves the right to reject warranties and to limit selections to products with warranties not in conflict with requirements of the Contract Documents.
- I. The County reserves the right to refuse to accept Work for the project where a special warranty, certification, or similar commitment is required on such work or part of the Work, until evidence is presented that entities required to counter-sign such commitments are willing to do so.
- J. Disclaimers and Limitations: Manufacturer's disclaimers and limitations on product warranties do not relieve the Contractor of the warranty on the Work that incorporates the products, nor does it relieve suppliers, manufacturers, and Subcontractors required to countersign special warranties with the Contractor.

PART 2 - PRODUCTS (NOT USED)

PART 3 - EXECUTION

3.01 DELIVERABLES

- A. Assemble warranties, bonds and service and maintenance contracts, executed by each of the respective manufacturers, suppliers, and Subcontractors, and bind into a commercial quality standard 3-ring binder; submit 5 copies of the warranties and bonds to the County for review.
 - 1. The warranties and bonds shall include:
 - a. Equipment or product description
 - b. Manufacturer's name, principal, address and telephone number

- c. Contractor, name of responsible principal, address and telephone number
- d. Local supplier's or representatives name and address
- e. Scope of warranty or bond
- f. Proper procedure in case of failure
- g. Instances which might affect the validity of warranty or bond
- h. Date of beginning of warranty, bond or service and maintenance contract
- i. Duration of warranty, bond or service maintenance contract

B. Warranties

1. Furnish an extended warranty for sanitary sewer main liner certified by the manufacturer for specified material properties for a particular job. The manufacturer warrants the liner to be free from defects in raw materials for 1-year from the date of acceptance. During the warranty period, any defects which affect the integrity or strength of the pipe shall be repaired at the Contractor's expense in a manner acceptable to the County.
2. Furnish an extended warranty for sanitary lateral liner certified by the manufacturer for specified material properties for a particular job. The manufacturer warrants the liner to be free from defects in raw materials for 1-year from the date of acceptance. During the warranty period, any defects which affect the integrity or strength of the pipe shall be repaired at the Contractor's expense in a manner acceptable to the County.

END OF SECTION

SECTION 02050
DEMOLITION OF EXISTING STRUCTURES

PART 1 - GENERAL

1.01 DESCRIPTION

A. Scope of Work

1. This Section specifies the labor, materials, equipment, and incidentals required for the demolition, relocation, and/or disposal of all structures, building materials, equipment, and accessories to be removed as shown on the Drawings and as specified herein.
2. There may be existing and active stormwater, wastewater, water, and other facilities on site as indicated on the Drawings. It is essential that these facilities, when encountered, remain intact and in service during the proposed demolition. Consequently, the Contractor shall be responsible for the protection of these facilities and shall diligently direct all his activities toward maintaining continuous operation of the existing facilities and minimizing operational inconvenience.
3. Demolition generally includes:
 - a. Complete demolition and removal of manholes, valve vaults, wetwells, piping, and mechanical and electrical equipment related to the Work as shown on the Drawings and specified herein.
 - b. Complete demolition and removal of all above and below ground structures, concrete slabs and foundations, vaults, and underground utilities (water, wastewater, electrical, etc.) as shown on the Drawings and specified herein.
 - c. All material, equipment, rubble, debris, and other products of the demolition shall become the property of the Contractor for his disposal off-site in accordance with all applicable laws and ordinances at the Contractor's expense. The sale of salvageable materials by the Contractor shall only be conducted off-site. The sale of removed items on the site is prohibited by the County.
4. The Contractor shall examine the various Drawings, visit the site, determine the extent of the Work, the extent of work affected therein, and all conditions under which he is required to perform the various operations.
5. The Contractor shall fill and compact all voids left by the removal of pipe, structures, etc. with materials described herein to a grade that will provide for positive drainage of the disturbed area to drain run-off in direction consistent with the surrounding area. The Contractor shall provide all fill materials to the site as needed. Compaction of fill shall match the compaction of adjacent undisturbed material.

1.02 QUALITY ASSURANCE

- A. Permits and Licenses: Contractor shall obtain all necessary permits and licenses for performing the Work and shall furnish a copy of same to the County prior to commencing the Work. The Contractor shall comply with the requirements of the permits.

- B. Notices: Contractor shall issue written notices of planned demolition to companies or local authorities owning utility conduit, wires, or pipes running to or through the project site. Copies of said notices shall be submitted to the County.
- C. Utility Services: Contractor shall notify utility companies or local authorities furnishing gas, water, electrical, telephone, or sewer service to remove any equipment in the structures to be demolished and to remove, disconnect, cap, or plug their services to facilitate demolition.
- D. Contractor shall notify the Orange County Risk Management Department in writing prior to beginning any demolition work.

1.03 SHOP DRAWINGS AND SUBMITTALS

- A. Submittals shall be submitted to the County for review and acceptance prior to construction in accordance with the General Conditions and specifications Section 01300 "Submittals."
- B. Submit to the County for their approval, 2 copies of proposed methods and operations of demolition or relocation of the structures specified below prior to the start of Work. Include in the schedule the coordination of shut-off, capping, and continuation of utility service as required.
- C. Provide a detailed sequence of demolition and removal work to ensure the uninterrupted progress of the County's operations.
- D. Before commencing demolition work, all structure relocation, bypassing, capping, or modifications necessary will be completed. Actual work will not begin until the County has inspected and approved the prerequisite work and authorized commencement of the demolition work.
- E. The above procedure must be followed for each individual demolition operation.

1.04 SITE CONDITIONS

- A. Prior to demolition, the Contractor shall obtain written verification from the utility owner(s) that the existing utilities, including stormwater, wastewater, and/or water facilities, are not operational and are ready for demolition.
- B. The County assumes no responsibility for the actual condition of the structures to be demolished or relocated.
- C. Conditions existing at the time of inspection for bidding purposes will be maintained by the County insofar as practicable. However, variations within each site may occur prior to the start of demolition work.
- D. No additional payment will be made for pumping or other difficulties encountered due to water.

- E. Certain information regarding the reputed presence, size, character and location of existing underground structures, pipes and conduit has been shown on the Drawings. There is no certainty of the accuracy of this information, and the location of underground structures shown may be inaccurate and other obstructions than those shown may be encountered. The Contractor hereby distinctly agrees that the County is not responsible for the correctness or sufficiency of the information given; that in no event is this information to be considered as a part of the Contract; that he shall have no claim for delay or extra compensation on account of incorrectness of information regarding obstructions either revealed or not revealed by the Drawings; and that he shall have no claim for relief from any obligation or responsibility under this Contract in case the location, size, or character of any pipe or other underground structure is not as indicated on the Drawings, or in case any pipe or other underground structure is encountered that is not shown on the Drawings.

1.05 RESTRICTIONS

- A. No building, tank or structure, or any part thereof, shall be demolished until an application has been filed by the Contractor with the Building Department Inspector and a permit issued if a permit is required. The fee for this permit shall be the Contractor's responsibility. Demolition shall be in accordance with applicable provisions of the Building Code of the State of Florida.
- B. No explosives shall be used at any time during the demolition. No burning of combustible material will be allowed.
- C. Contractor shall notify the Orange County Risk Management Department prior to beginning any demolition work.

1.06 DISPOSAL OF MATERIAL

- A. All salvageable or useable material or equipment to be retained by the County shall be shown on Drawings, and shall be moved to a designated area by Contractor for pick up by County. The Contractor shall promptly remove all other materials from the site as indicated or shown on the Drawings.
- B. All materials not retained by the County shall become the Contractor's property and shall be removed off-site.
- C. The on-site storage of removed items is prohibited by the County. Off-site sale of salvageable material by the Contractor is acceptable.

1.07 TRAFFIC AND ACCESS

- A. Conduct work to ensure minimum interference with on-site and off-site roads, streets, sidewalks, and occupied or used facilities.

- B. Special attention is directed towards maintaining safe and convenient access to the existing facilities remaining in operation by plant personnel and plant associated vehicles, including trucks and delivery vehicles.
- C. Do not close or obstruct streets, sidewalks, or other occupied or used facilities without permission from the County. Provide alternate routes around closed or obstructed traffic in access ways.

1.08 PROTECTION

- A. Conduct operations to minimize damage by falling debris or other causes to adjacent buildings, structures, roadways, other facilities, and persons. Provide interior and exterior shoring, bracing, or support to prevent movement or settlement or collapse of structures to be demolished and adjacent facilities to remain.

1.09 DAMAGE

- A. Promptly repair damage caused to adjacent facilities by demolition operations as directed by the County at no cost to the County.

1.10 UTILITIES

- A. Maintain existing utilities as directed by the County to remain in service and protect against damage during demolition operations.
- B. Do not interrupt existing utilities serving occupied or operational facilities, except when authorized by County. Provide temporary services during interruptions to existing utilities as acceptable to the County.
- C. The Contractor shall cooperate with the County to shut off utilities serving structures of the existing facilities as required by demolition operations.
- D. The Contractor shall be solely responsible for making all necessary arrangements and for performing any necessary work involved in connection with the interruption of all public and private utilities or services.
- E. All utilities being abandoned shall be terminated at the service mains in conformance with the requirement of the utility companies or the municipality owning or controlling them.

1.11 EXTERMINATION

- A. If required, before starting demolition, the Contractor shall employ a certified rodent and vermin exterminator and treat the facilities in accordance with governing health laws and regulations. Any rodents, insects, or other vermin appearing before or during the demolition shall be killed or otherwise prevented from leaving the immediate vicinity of the demolition work.

1.12 POLLUTION CONTROL

- A. For pollution control, use water sprinkling, temporary enclosures, and other suitable methods as necessary to limit the amount of dust rising and scattering in the air to the lowest level of air pollution practical for the conditions of work. The Contractor shall comply with the governing regulations.
- B. Clean adjacent structures and improvements of all dust and debris caused by demolition operations as directed by the County. Return areas to conditions existing prior to the start of Work.

PART 2 - PRODUCTS (NOT USED)

PART 3 - EXECUTION

3.01 SEQUENCE OF WORK

- A. The sequence of demolition and relocation of existing facilities shall be in accordance with the approved critical path schedule as specified in paragraph 1.03 above.

3.02 REMOVAL OF EXISTING PROCESS EQUIPMENT, PIPING, AND APPURTENANCES

- A. Equipment to be retained by the County will be designated for retention by the County prior to bidding as specified in Paragraph 1.06 above. Subject to the constraints of maintaining existing facilities in operation as shown on the Drawings, all other process equipment, non-buried valving and piping, and appurtenances shall be removed from the site.

3.03 DEMOLITION PROCEDURES

The Contractor shall adhere to the following demolition procedures as referenced on the Drawings:

- A. **TO BE DEMOLISHED:** Demolition shall be the breaking up, cutting, filling of any holes resulting, final grading of the area, performing any other operations required, and the removal from the site of all structures and equipment (structures, substructures, floor slabs, equipment, tanks, pipes, fittings, electrical systems, light poles, wiring, underground conduits and wiring, isolated slabs, and sidewalks) as indicated on the Drawings. All pieces of concrete, metal, and any other demolished material shall be removed to a depth of at least 5-feet below existing grade. Broken pieces of concrete may be size reduced by an on-site crusher, but in any event must be removed from the project site.

Before commencing structural demolition, remove all mechanical, electrical, piping, and miscellaneous appurtenances. Completely remove the structure by thoroughly breaking up concrete into pieces no more than 2-feet across the largest dimension.

- B. TO BE REMOVED: Where indicated on the Drawings, the structures and equipment shall be completely removed from the site with all associated connecting piping or electrical service. The item shall be taken whole or in parts to be salvaged or disposed of by the Contractor.
- C. TO BE ABANDONED: Where indicated on the Drawings, the structures and equipment shall be left in place, drained, and the contents properly disposed. The upper 4-feet of the structure shall be cut and removed, including the cover slab and access port, frame, and cover. All structures to be abandoned with bottom slabs shall be drilled (2 holes minimum, 2.0-inch diameter each) or hole punched to prevent flotation and filled with common fill.
- D. PIPING TO BE REMOVED: Where indicated on the Drawings, pipe (and conduit) shall be drained and the contents properly disposed. The pipe (or conduit) shall then be completely removed from the site, including fittings, valves, and other in-line devices. Connections to existing piping to remain shall be plugged by mechanical means (M.J. plugs, tie-rods, or thrust blocks). Piping shall be removed in accordance with Specification Section 02080 "Abandonment, Removal and Salvage or Disposal of Existing Pipe."
- E. PIPING TO BE ABANDONED: Where indicated on the Drawings, piping (or conduit) shall be left in place. All such piping shall be drained and the contents properly disposed. The pipe (or conduit) shall then be filled with grout (flowable fill) and each end of the pipe (or conduit) shall be plugged using a concrete plug in a manner acceptable to the County. Piping shall be abandoned in accordance with Specification Section 02080 "Abandonment, Removal and Salvage or Disposal of Existing Pipe."
- F. TO BE PROTECTED: Where indicated on the Drawings, the utility service, fence, structure, tree, or device so designated shall be temporarily protected during the prosecution of the demolition work as specified in Division 1.
- G. TO REMAIN: Where indicated on the Drawings, the designated facilities shall remain intact and in service during the prosecution of the demolition work.

3.04 DEWATERING OF EXISTING PROCESS UNITS AND DISPOSAL OF RESIDUE

The Contractor shall notify the County prior to beginning the dewatering work on any existing process units which contain wastewater, grit, or sludge. The Contractor, at his own expense, shall remove the entire contents of each structure and dispose off site. The proper transport and disposal of all residues shall remain the responsibility of the Contractor.

END OF SECTION

SECTION 02080

ABANDONMENT, REMOVAL, AND SALVAGE OR DISPOSAL OF EXISTING PIPE

PART 1 - GENERAL

1.01 DESCRIPTION

- A. Scope of Work: This section specifies the furnishing of all labor, materials, equipment, and incidentals required to abandon, remove, salvage, and/or dispose of existing pipelines and appurtenances as shown on the Drawings and as specified herein.

1.02 QUALITY ASSURANCE

- A. Permits and Licenses: Contractor shall obtain and pay respective fees for all necessary permits and licenses for performing the Work and shall furnish a copy of same to the County prior to commencing the Work. The Contractor shall comply with the requirements of the permits. All removal or abandonment of asbestos pipe material shall be performed by a licensed asbestos abatement Contractor or Subcontractor registered in the State of Florida.
- B. Notices: Contractor shall issue written notices of planned Work to companies or local authorities owning utility conduit, wires, or pipes running to or through the project site. Copies of said notices shall be submitted to the County.
- C. Standards:
 - 1. Florida Administrative Code, Chapter 62-204.800
 - 2. National Emission Standards Hazardous Air Pollution (NESHAP), 40 CFR Part 61, Subpart M, latest revision
 - 3. Occupational Safety and Health Act, 29 CFR
 - 4. The Environmental Protection Agency (EPA) Asbestos Abatement Worker Protection Rule
 - 5. Florida Statute 455.300
 - 6. Asbestos pipe handling best management practices provided at the end of this section
- D. Quality Control
 - 1. It shall be the responsibility of the Contractor to provide supervision and inspections to ensure that the existing piping is removed and disposed, salvaged, or abandoned as designated in the Drawings and as specified herein.
 - 2. Asbestos Pipe
 - a. All removal or abandonment of pipe material containing asbestos shall be performed by a licensed asbestos abatement Contractor or Subcontractor.

- b. The asbestos abatement Contractor or Subcontractor shall contact the Orange County Environmental Protection Division (407-836-1400) prior to removal or abandonment of any asbestos material and shall obtain all required permits and licenses and issue all required notices as required by the Orange County Environmental Protection Division. The Contractor shall be responsible for all fees associated with permits, licenses, and notices to the governing regulatory agencies.
- c. The asbestos abatement Contractor shall perform Work in accordance with all applicable standards referenced in paragraph 1.02.C of this section.
- d. The asbestos abatement Contractor shall have experience performing asbestos removal similar to this Project.

1.03 SHOP DRAWINGS AND SUBMITTALS

A. Shop Drawings

1. Submittals shall be submitted to the County for review and acceptance prior to construction in accordance with the General Conditions and specifications Section 01300 "Submittals."
2. Shop Drawings shall be submitted to the County for review and acceptance prior to construction in accordance with these specifications for the following:
 - a. Grout
 - b. Caps and plugs
 - c. Credentials of licensed asbestos abatement Contractor including current certification.

PART 2 - PRODUCTS (NOT USED)

PART 3 - EXECUTION

3.01 REMOVAL, ABANDONMENT, SALVAGE, AND DISPOSAL

- A. General: Existing piping designated on the Drawings to be removed shall be exposed and removed by the Contractor.
- B. Removal and Disposal
 1. Pipe designated to be removed shall be completely drained and the contents properly disposed. The piping system including fittings and valves shall then be completely removed from the site.
 2. Existing services and/or connections not shown on the Drawings shall be removed in accordance with this section at no additional cost. Existing live services encountered shall be maintained.
 3. Asbestos: Pipe material containing asbestos shall be removed and disposed by a licensed asbestos abatement Contractor or Subcontractor.

4. Structures shall be removed in accordance with Section 02050 "Demolition of Existing Structures."

C. Removal of material to be salvaged

1. Pipe designated on the Drawings to be removed and salvaged shall be completely drained and the contents properly disposed. The pipe shall then be thoroughly pressure washed, palletized on wooden skids to a dimension not exceeding the recommendation of the manufacturer, and conveyed to the County at the location designated by the County.
2. Items to be salvaged:
 - a. Air release valves
 - b. Sanitary manhole rings and covers
 - c. Isolation valves
 - d. Valve boxes
 - e. Fire hydrant and valve assemblies

D. Abandonment

1. Pipe designated on the Drawings to be abandoned (or retired in place) shall be left in place, drained, and its contents properly disposed. Pipe requires end caps or plugs. All air release valves and vaults, valve boxes, fire hydrants, manholes, and manhole rings and covers shall be removed and disposed of or salvaged as specified above.
2. All pipe 4-inches or larger to be abandoned in place shall be completely filled with grout and each end of the pipe shall be plugged in a manner acceptable to the County.
3. Grout: Where designated on the Drawings, pipe to be abandoned shall be filled with grout in accordance with Section 03600 "Grouting."
4. Plugs: Pipe to be abandoned shall be capped or plugged with a mechanical joint fitting that will prevent soil or other deposits from entering the pipe.

E. Asbestos Pipe Handling Best Management Practices

1. Projects will require worker documentation before entering the regulated Work area. A copy of: their current training certificate (workers and their supervisor); current medical condition showing the doctor approved their working with asbestos and wearing a respirator; signed acknowledgment forms; and current record (6-months) of each workers respirator fit test will be required from all workers.
2. Projects also require air monitoring. OSHA will accept historic data on air monitoring within 12-months of the Project, provided the data is from a project of like material and conditions with a crew of the same experience, supervision, and training. Otherwise, monitoring is required throughout the Project. OSHA requires two (2) types of personnel air monitoring, full shift and 30-minute excursion level (when highest levels are anticipated).
3. Some provisions should be made for worker showering or otherwise washing following work before removing respirators, etc. Even if direct exposure is not anticipated, and at a minimum, a source of water to rinse the respirators, wash workers faces and hands, and (in the event of unanticipated direct exposure) some place to shower is required. The workers will also need a change room and some place to keep their street clothes and personal possessions.

4. Proposals to remove asbestos pipe sections by cutting must address how the cutting debris will be captured and kept from becoming airborne. Soil that could be considered contaminated may also have to be removed.
5. Licensed asbestos abatement Contractors or Subcontractors should have a pollution endorsement in their liability insurance in case of asbestos fiber release. A contingency plan, in case the project does not run as smoothly as expected, should be developed and include emergency phone numbers kept on site during the Project.
6. Daily logs of the asbestos removal work should be kept, and should include sign in sheets for the workers and whatever air monitoring was done. Accident reports and other reports or correspondence if something unusual happened should also be included.
7. Waste receipts must be kept through all stages of transport from the site to, and including, the acceptance at the dumpsite where the material will be abandoned. Amount of material removed must be equal to the amount of material to be turned into to the dump.
8. The primary Contractor will give "approval for tear down" at project completion, indicating that all asbestos removal operations are complete and whether there is a need for any air monitoring. Air monitoring, if not required by any governing agency or approved permit as discussed previously, may also be required by the County if documentation to the general public pertaining to contamination is deemed necessary. This air monitoring is normally done by collecting area samples downwind of the project at the barrier tape or just inside it. It requires a source of electricity to run the pumps, which is often provided by a generator.

END OF SECTION

SECTION 02100
TEMPORARY EROSION AND SEDIMENTATION CONTROL

PART 1 - GENERAL

1.01 DESCRIPTION

A. Scope of Work

1. The Work specified in this Section consists of designing, providing, maintaining and removing temporary erosion, sedimentation and turbidity controls as necessary.
2. Temporary erosion controls include, but are not limited to, grassing, mulching, setting, watering and reseeding on-site surfaces and soil and borrow area surfaces and providing interceptor ditches at ends of berms and at those locations which will ensure that erosion during construction will be either eliminated or maintained within acceptable limits as established by federal, state and local requirements and by the County.
3. Temporary sedimentation controls include, but are not limited to; silt fence, silt dams, traps, barriers, and appurtenances at the foot of sloped surfaces which will ensure that sedimentation pollution will be either eliminated or maintained within acceptable limits as established by federal, state and local requirements and by the County.
4. Temporary turbidity controls include, but are not limited to, floating or staked turbidity barriers which will ensure that turbidity pollution will be either eliminated or maintained within acceptable limits as established by Federal, state, and local requirements and by the County.
5. Contractor is responsible for providing effective temporary erosion, sediment, and turbidity control measures during construction or until permanent controls become effective.

- B. Related Work Described Elsewhere: South Florida Building Code and Standard Building Code, FDOT Standard Specifications for road and bridge construction and FDOT Design Standards.

PART 2 - PRODUCTS

2.01 EROSION CONTROL

- A. Netting Fence: fabricated of material acceptable to the County.
- B. Sod is specified in Section 02578, "Solid Sodding."

2.02 SEDIMENTATION CONTROL

- A. Bales: clean, seed-free cereal hay type.
- B. Netting: fabricated of material acceptable to the County.
- C. Filter stone: crushed stone conforming to Florida Department of Transportation specifications.

- D. Concrete block: hollow, non-load bearing type.
- E. Concrete: exterior grade not less than 1-inch thick.
- F. Rock Bags: conforming to FDOT Specifications.

2.03 TURBIDITY CONTROL

- A. Conforming to FDOT Design Standards Index 103 - Turbidity Barriers.

PART 3 - EXECUTION

3.01 EROSION CONTROL

- A. Minimum Procedures for Grassing Are:
 1. Scarify slopes to a depth of not less than 6-inches and remove large clods, rock, stumps and roots larger than 1/2-inch in diameter and debris.
 2. Sow seed within 24-hours after the ground is scarified with either mechanical seed drills or rotary hand seeders.
 3. Apply mulch loosely and to a thickness of between 3/4-inch and 1-1/2-inches.
 4. Apply netting over mulched areas on sloped surfaces.
 5. Roll and water seeded areas in a manner which will encourage sprouting of seeds and growing of grass. Reseed areas which exhibit unsatisfactory growth. Backfill and seed eroded areas.

3.02 SEDIMENTATION CONTROL

- A. Install and maintain silt fence, silt dams, traps, barriers and appurtenances as shown on the approved descriptions and working Drawings. Hay bales which deteriorate and filter stone which is dislodged shall be replaced.

3.03 TURBIDITY CONTROL

- A. Install and maintain turbidity barriers daily and as described in FDOT Index #103.

3.04 PERFORMANCE

- A. Should any of the temporary erosion and sediment control measures employed by the Contractor fail to produce results which comply with the requirements of the State of Florida, the Contractor shall immediately take whatever steps are necessary to correct the deficiency at his own expense.

END OF SECTION

SECTION 02140

DEWATERING

PART 1 - GENERAL

1.01 DESCRIPTION

- A. **Scope of Work:** This Section specifies the furnishing of equipment; labor and materials necessary to remove storm or subsurface waters from excavation areas in accordance with the requirements set forth, as shown on the Drawings, and/or geotechnical report.

1.02 QUALITY ASSURANCE

- A. **Qualifications:** The Contractor shall engage a Geotechnical Engineer registered in the State of Florida, to design the temporary dewatering system. The Contractor shall submit conceptual plan for the dewatering system prior to commencing work. The dewatering system installed shall be in conformity with the overall construction plan and certification of this shall be provided by the Geotechnical Engineer. The dewatering system shall be designed by a firm who regularly engages in the design of dewatering systems and who is fully experienced, reputable and qualified in the design of such dewatering systems.
- B. The dewatering of any excavation areas and the disposal of the water shall be in strict accordance with the latest revision of all local and state government rules and regulations.
- C. **Permits:** The Contractor shall obtain and pay respective fees for all local, state, and federal permits (including the Orange County, St. Johns River Water Management District, and/or South Florida Management District discharge permits) required for the withdrawal, treatment and disposal/discharge of water from the dewatering operation, prior to start of work.
- D. Comply with Florida Administrative Code, Chapter 62-621.300 (2).

1.03 SHOP DRAWINGS AND SUBMITTALS

- A. Submittals shall be submitted to the County for review and acceptance prior to construction in accordance with the General Conditions and specifications Section 01300 "Submittals."
- B. In accordance with FAC 62-621.300(2), submit analytical test results from a certified laboratory for the parameters listed in the FDEP "Generic Permit for the Discharge of Produced Ground Water from Any Non-Contaminated Site Activity" to the FDEP and the County. The submitted information shall show the location of the work, where the water will be going to, as well as an estimate for the amount, rate and duration of discharge being proposed.

- C. Provide notification to all jurisdictional permitting agencies in accordance with the requirements of the respective agency.
- D. Provide a detailed plan and operation schedule for dewatering of excavations.
 - 1. Provide descriptive literature of the dewatering system.
 - 2. Provide a plan for erosion and sedimentation control during dewatering.
 - 3. Provide copies of all permits/approvals for disposal/discharge of water during dewatering.

PART 2 - PRODUCTS (NOT USED)

PART 3 - EXECUTION

3.01 GENERAL

- A. The Contractor shall have on-site and available the analytical test results performed in accordance with the FDEP "Generic Permit for the Discharge of Produced Ground Water from Any Non-Contaminated Site Activity" (FAC 62-621.300(2)).
- B. The Contractor shall provide adequate equipment for the removal of storm or subsurface waters which may accumulate within the excavation.
- C. The Contractor's attention is directed to the water surface elevations discussed in the report(s) on subsurface investigations. Water levels will normally vary from season to season.
- D. The Contractor shall be required to monitor the performance of the dewatering system during the progress of the Work and make such modifications as may be required to assure that the systems will perform satisfactorily. The dewatering system shall be designed in such a manner as to preserve the undisturbed bearing capacity of the sub-grade soils at the bottom of the trench or excavation.
- E. Prior to excavation, the Contractor shall submit his proposed method of dewatering and maintaining dry conditions to the County. Approval of the dewatering plan shall not relieve the Contractor of the responsibility for the satisfactory performance of the system. The Contractor shall be responsible for correcting any disturbance of natural bearing soils or damage to structures caused by an inadequate dewatering system or by interruption of the continuous operation of the system as specified.
- F. If subsurface water is encountered, the Contractor shall utilize suitable equipment to adequately dewater the excavation. A wellpoint system or other County acceptable dewatering method shall be utilized if necessary to maintain the excavation in a dry condition for preparation of the trench bottom and for pipe laying. Within and adjacent to residential areas and other areas as required by the County, engines driving dewatering pumps shall be equipped with residential type mufflers and the noise shall not exceed 55 decibels within 50-feet.

3.02 DEWATERING AND DISPOSAL

- A. The Contractor shall construct and place all pipelines, structures, concrete work, structural fill, backfill and bedding material in-the-dry. In addition, the Contractor shall make the final 24-inches of excavation in-the-dry and not until the water level is a minimum of 2-foot below proposed bottom of excavation. For purposes of this Contract, in-the-dry is defined as $\pm 2\%$ of the optimum moisture content of the soil.
- B. The Contractor shall, at all times during construction, provide and maintain proper equipment and facilities to remove promptly and dispose of all water entering excavations. Contractor shall keep excavations dry so as to obtain a satisfactory undisturbed subgrade foundation condition until the fill, structure, or pipes have been completed to such extent that they will not be floated or otherwise damaged by allowing water levels to return to natural elevations.
- C. Dewatering shall at all times be conducted in such a manner as to preserve the natural undisturbed bearing capacity of the subgrade soils at proposed bottom of excavation.
- D. It is expected that dewatering will be required for pre-drainage of the soils prior to final excavation for most of the in-ground structures or piping and for maintaining the lowered groundwater level until construction has been completed so that the structure, pipeline or fill will not be floated or otherwise damaged.
- E. If wellpoints are used, Contractor shall adequately space wellpoints to maintain the necessary dewatering. Provide suitable filter sand and/or other means to prevent pumping of fine sands and silts. A continual check shall be maintained by the Contractor to ensure that the subsurface soil is not being removed by the dewatering operations. Pumping from wellpoints shall be continuous and standby pumps shall be provided.
- F. The Contractor's proposed method of dewatering shall include groundwater observation wells to determine the water level during construction. Observation wells shall be installed along pipelines as required to verify depth to water level and at locations approved by the County.
- G. At all times, site grading shall promote drainage. Surface runoff shall be diverted from excavations. Water entering the excavation from the surface shall be collected in shallow ditches around the perimeter of the excavation, drained to sumps, and pumped or drained by gravity to maintain an excavation bottom free from standing water.
- H. Flotation shall be prevented by the Contractor by maintaining a positive and continuous removal of water. The Contractor shall be fully responsible for all damages which may result from failure to adequately keep excavations dewatered.
- I. The Contractor shall dispose of water from the Work in a suitable manner without damage to adjacent properties or facilities. No water shall be discharged without appropriate treatment for adverse contaminants. No water shall be drained in work built or under construction without prior consent from the County. Water shall be filtered to remove sand and fine soil particles before disposal into any drainage system.

- J. Dewatering of excavations shall be considered incidental to the construction of the Work and all costs shall be included in the various Contract prices in the Bid Form, unless a separate bid item has been established for dewatering.

3.03 GROUNDWATER TREATMENT (IF REQUIRED)

- A. If concentrations of tested groundwater quality parameters exceed those allowable in the FDEP Generic Permit for the Discharge of Produced Groundwater from any Non-Contaminated Site Activity (62-621.300(2), F.A.C.), the Contractor shall treat the effluent.
- B. The Contractor shall immediately notify the County and discuss the parameters that exceed allowable limits.
- C. The Contractor shall meet with the FDEP to determine alternatives that are acceptable to the FDEP.
- D. The Contractor shall apply for and obtain any and all permits and/or treatment approvals that FDEP requires including but not limited to:
 - 1. Generic Permit for Discharges from Petroleum Contaminated Sites (62-621.300(1)). Allows discharges from sites with automotive gasoline, aviation gasoline, jet fuel, or diesel fuel contamination; or
 - 2. Permit for all Other Contaminated Sites (62-04; 62-302; 62-620 & 62-660). The coverage is available only through the individual NPDES permit issued by FDEP, allows discharges from sites with general contaminant issues i.e. ground water and/or soil contamination other than petroleum fuel contamination; or
 - 3. Generic Permit for the Discharge of Produced Ground Water from Any Non-Contaminated Site Activity (62-621.300(2), F.A.C.); or
 - 4. Generic Permit for Stormwater Discharge from Large or Small Construction Activities (62-621.300(4)(a), F.A.C.); or
 - 5. An Individual Wastewater Permit (62-604.300(8) (a))
- E. The Contractor shall implement the appropriate treatment that is acceptable to FDEP and County to attain compliance for all excess limits encountered during dewatering activities. Treatment may include, but is not limited to: Chemical, Biological, Electrolysis or any combination of the three.
- F. The Contractor shall make every effort to minimize the spread of contamination into uncontaminated areas. Provide for the health and safety of all workers at the job site and make provisions necessary for the health and safety of the public that may be exposed to any potentially hazardous conditions. Ensure provision adhere to all applicable laws, rules or regulations covering hazardous conditions and will be in a manner commensurate with the level of severity of the conditions.
- G. If necessary, provide contamination assessment and remediation personnel to handle site assessment, determine the course of action necessary for site security and perform the necessary steps under applicable laws, rules and regulations for additional assessment and/or remediation work to resolve the contaminations issue.

- H. Delineate the contamination area(s) and any staging or holding area required and develop a work plan that will provide the schedule of projected completion dates for the final resolution of the contamination issue.
- I. Maintain jurisdiction over activities inside any delineated contamination areas and any associated staging or holding areas. Be responsible for the health and safety of workers within the delineated areas. Provide continuous access to representatives of regulatory or enforcement agencies having jurisdiction.

3.04 REMOVAL

Immediately upon completion of the dewatering system, the Contractor shall remove all of his equipment, materials, and supplies from the site of the Work, remove all surplus materials and debris, fill in all holes or excavations, and grade the site to elevations of the surface levels which existed before work started. The site shall be thoroughly cleaned and approved by the County.

END OF SECTION

1

THIS PAGE LEFT BLANK INTENTIONALLY

SECTION 02215
FINISH GRADING

PART 1 - GENERAL

1.01 DESCRIPTION

- A. Scope of Work: Provide finish grading to all areas within the limits of construction.
- B. Grade sub-soil. Cut out areas to receive stabilizing base course materials for paving and sidewalks. Place, finish grade, and compact topsoil.

1.02 PROTECTION

- A. Prevent damage to existing fencing, trees, landscaping, natural features, benchmarks, pavement, and utility lines. Correct damage at no cost to the County.

1.03 SHOP DRAWINGS AND SUBMITTALS

- A. Submittals shall be submitted to the County for review and acceptance prior to construction in accordance with the General Conditions and specifications Section 01300 "Submittals."

PART 2 - PRODUCTS

2.01 MATERIALS

- A. All material supplied shall be one of the products specified in Appendix D "List of Approved Products" appended to these technical specifications.
- B. Topsoil: Friable loam free from subsoil, roots, grass, excessive amount of weeds, stones, and foreign matter; acidity range (pH) of 5.5 to 7.5; containing a minimum of 4% and a maximum of 25% organic matter. The topsoil shall be suitable for the proposed plant growth shown on the Drawings and specified. Use topsoil stockpiles on site if conforming to these requirements. If there is not sufficient topsoil available at the project site, the Contractor shall furnish additional topsoil as required to complete the Work at no additional cost to the County.

PART 3 - EXECUTION

3.01 SUB SOIL PREPARATION

- A. Rough grade sub-soil systematically to allow for a maximum amount of natural settlement and compaction. Eliminate uneven areas and low spots. Remove debris, roots, branches, stones, etc. Remove sub-soil that has been contaminated with petroleum products.

- B. Cut out areas to subgrade elevation which are to receive stabilizing base for paving and sidewalks.
- C. Bring sub soil to required levels, profiles, and contours. Make changes in grade gradual. Blend slopes into level areas.
- D. Slope grade away from building a minimum of 2-inches in 10-feet unless indicated otherwise on the Drawings.
- E. Cultivate subgrade to a depth of 3-inches where topsoil is to be placed. Repeat cultivation in areas where equipment used for hauling and spreading topsoil has compacted sub-soil.

3.02 PLACING TOPSOIL

- A. Place topsoil in areas where seeding, sodding, and planting is to be performed. Place to the following minimum depths, up to finished grade elevations.
 - 1. 6-inches for seeded areas
 - 2. 4-1/2-inches for sodded areas
 - 3. 24-inches for shrub beds
 - 4. 18-inches for flower beds
- B. Use topsoil in relatively dry state. Place during dry weather.
- C. Fine grade topsoil eliminating rough and low areas to ensure positive drainage. Maintain levels, profiles, and contours of subgrades.
- D. Remove stones, roots, grass, weeds, debris, and other foreign material while spreading.
- E. Manually spread topsoil around trees, plants, and buildings to prevent damage which may be caused by grading equipment.
- F. Lightly compact placed topsoil.

3.03 SURPLUS MATERIAL

- A. Remove surplus sub soil and topsoil from site.
- B. Leave stockpile areas and entire job site clean and raked, ready to receive landscaping.

END OF SECTION

SECTION 02220
EXCAVATING, BACKFILLING, AND COMPACTING

PART 1 - GENERAL

1.01 DESCRIPTION

- A. Scope of Work: Excavate, backfill, and compact as required for the construction of the utility system consisting of piping and appurtenances, and structural construction as shown on the Drawings and specified herein. The Contractor shall furnish all labor, materials, equipment, and incidentals necessary to perform all excavation, backfill, compaction, grading, and slope protection to complete the Work. The Contractor shall be responsible for having determined to his satisfaction, prior to the submission of his bid, all under ground utilities locations and appurtenances shown on the construction Drawings.
- B. Definitions:
1. Maximum Density: Maximum weight in pounds per cubic foot of a specific material as determined by AASHTO T-180 (ASTM D155).
 2. Optimum Moisture: Percentage of water in a specific material at maximum density.
 3. Rock Excavation: Excavation of any hard natural substance which requires the use of explosives and/or special impact tools such as jack hammers, sledges, chisels, or similar devices specifically designed for use in cutting or breaking rock, but exclusive of trench excavating machinery.
 4. Suitable: Suitable materials for fills shall be non-cohesive, non-plastic granular local sand and shall be free from vegetation, organic material, marl, silt, or muck. The Contractor shall furnish all additional fill material required.
 5. Unsuitable: Unsuitable materials are highly organic soil (peat or muck) classified as A-8 in accordance with AASHTO Designation M 145.
- C. Plan For Earthwork: The Contractor shall be responsible for having determined to his satisfaction, prior to the submission of his bid, the conformation of the ground, the character and quality of the substrata, the types and quantities of materials to be encountered, the nature of the groundwater conditions, the prosecution of the Work, the general and local conditions, and all other matters which can in any way affect the Work under this Contract. Prior to commencing the excavation, the Contractor shall submit a plan of his proposed operations, including maintenance of traffic, to the County for review. The Contractor shall consider, and his plan for excavation shall reflect, the equipment and methods to be employed in the excavation. The prices established in the Proposal for the Work to be done will reflect all costs pertaining to the Work.

1.02 QUALITY ASSURANCE

- A. Testing laboratory employed by the County will make such tests as are deemed advisable. The Contractor shall schedule his work to permit a reasonable time for testing before placing succeeding lifts and shall keep the laboratory informed of his progress. Costs for initial testing shall be paid by the County; however, tests which have to be repeated because of the failure of the tested material to meet specification shall be paid for by the Contractor and the cost of re-testing shall be deducted from payments due the Contractor.
- B. Standards
 - 1. AASHTO: American Association of State Highway and Transportation Officials
 - 2. ANSI: American National Standards Institute
 - 3. ASCE: American Society of Civil Engineers
 - 4. ASTM: American Society for Testing and Materials
 - 5. AWWA: American Water Works Association
 - 6. OSHA 29 CFR Subpart P – Excavations and Trenches a) 1926.650, 1926.651, 1926.652
 - 7. OSHA 29 CFR Subpart J - a) 1910.146 for Confined Space Entry

1.03 JOB CONDITIONS

- A. Existing Utilities
 - 1. The Contractor is responsible for subsurface verification of existing utilities prior to construction. Locate existing utilities in the area of work in accordance with Sunshine State One Call regulations, Chapter 556, "Underground Facility Damage Prevention and Safety Act", FS.
 - 2. Should uncharted or incorrectly charted piping or other utility be encountered during excavation, notify the County. Keep all facilities in operation and repair damaged utilities to the satisfaction of the County.
 - 3. Damage and repair costs to such piping or utilities are the Contractor's responsibility.
 - 4. If utilities are to remain in place, the Contractor shall provide adequate means of protection.
- B. Test borings and the sub-surface exploration data if previously done on the site will be made available upon request and are for the Contractor's information only.

1.04 PROTECTION

- A. Sheet piling and Bracing
 - 1. Requirements of the Trench Safety Act shall be adhered to at all times.

2. Furnish, put in place, and maintain such sheeting and bracing as may be required to support the sides of excavations, to prevent any movement which could in any way diminish the width of the excavation below that necessary for proper construction, to protect adjacent structures and power poles from undermining, and to protect workers from hazardous conditions or other damage. Such support shall consist of braced steel sheet piling, braced wood lagging and soldier beams or other acceptable methods. If the County is of the opinion that at any point sufficient or proper supports have not been provided, the County may order additional supports put in at the expense of the Contractor, and compliance with such order shall not relieve or release the Contractor from his responsibility for the sufficiency of such supports. Care shall be taken to prevent voids outside of the sheeting, but if voids are formed, they shall be immediately filled and compacted. Where soil cannot be properly compacted to fill a void, lean concrete shall be used as backfill at no additional expense to the County.
3. The Contractor shall construct the sheeting outside the neat lines of the foundation unless indicated otherwise for the method of operation. Sheeting shall be plumb and securely braced and tied in position. Sheeting and bracing shall be adequate to withstand all pressure to which the structure or trench will be subjected. Any movement or bulging which may occur shall be corrected by the Contractor at their own expense so as to provide the necessary clearances and dimensions.
4. Where sheeting and bracing is required to support the sides of excavations for structures, the Contractor shall engage a Professional Geotechnical Engineer, registered in the State of Florida, to design the sheeting and bracing. The sheeting and bracing installed shall be in conformity with the design, and the Professional Engineer shall provide certification of this.
5. The installation of sheeting, particularly by driving or vibrating, may cause distress to existing structures. The Contractor shall evaluate the potential for such distress and, if necessary, take all precautions to prevent distress of existing structures because of sheeting installation.
6. The Contractor shall leave in place to be embedded in the backfill all sheeting and bracing not shown on the Drawings but which the County may direct him in writing to leave in place at any time during the progress of the Work for the purpose of preventing damage to structures, utilities, or property, whether public or private. The County may direct that timber used for sheeting and bracing be cut off at any specified elevation.
7. All sheeting and bracing not left in place shall be carefully removed in such manner as not to endanger the construction or other structures, utilities, or property. All voids left or caused by withdrawal of sheeting shall be immediately refilled with sand by ramming with tools especially adapted to that purpose, or otherwise as may be directed by the County.
8. The right of the County to order sheeting and bracing left in place shall not be construed as creating any obligation on the County's part to issue such orders, and their failure to exercise this right shall not relieve the Contractor from liability for damages to persons or property occurring from or upon the Work occasioned by negligence or otherwise, growing out of a failure on the part of the Contractor to leave in place sufficient sheeting and bracing to prevent any caving or moving of the ground.

9. No wood sheeting is to be withdrawn if driven below mid-diameter of any pipe, and under no circumstances shall any wood sheeting be cut off at a level lower than 1-foot above the top of any pipe.

B. Pumping and Drainage:

1. The Contractor shall at all times during construction provide and maintain proper equipment and facilities to remove all water entering excavations, and shall keep such excavations dry so as to obtain a satisfactory undisturbed subgrade foundation condition until the fills, structures, or pipes to be built thereon have been completed to such extent that they will not be floated or otherwise damaged by allowing the water level to return to the natural level as stipulated in Section 02140 "Dewatering." The Contractor shall engage a Professional Geotechnical Engineer registered in the State of Florida to design the dewatering systems. The Contractor shall submit to the County for a plan for dewatering systems prior to commencing work. The dewatering system installed shall be in conformity with the overall construction plan, and the Professional Engineer shall provide certification of this. The Professional Engineer shall be required to monitor the performance of the dewatering systems during the progress of the Work and require such modifications as may be required to assure that the systems are performing satisfactorily.
2. Dewatering shall at all times be conducted in such a manner as to preserve the undisturbed bearing capacity of the subgrade soils at the proposed bottom of excavation and to preserve the integrity of adjacent structures. Dewatering by trench pumping will not be permitted if migration of fine grained natural material from bottom, sidewalls, or bedding material will occur.
3. Water entering the excavation from surface runoff shall be collected in shallow ditches around the perimeter of the excavation, drained to sumps, and pumped from the excavation to maintain a bottom free from standing water.
4. The Contractor shall take all additional precautions to prevent uplift of any structure during construction.
5. Permission to use any storm sewers or drains for water disposal purposes shall be obtained from the authority having jurisdiction. Any requirements and costs for such use shall be the responsibility of the Contractor. However, the Contractor shall not cause flooding by overloading or blocking up the flow in the drainage facilities, and he shall leave the facilities unrestricted and as clean as originally found. Any damage to facilities shall be repaired or restored as directed by the County or the authority having jurisdiction, at no cost to the County.
6. The Contractor shall prevent flotation by maintaining a positive and continuous operation of the dewatering system. The Contractor shall be fully responsible and liable for all damages which may result from failure of this system.
7. Removal of dewatering equipment shall be accomplished after compaction/density testing has been completed and the system is no longer required. The Contractor shall remove the material and equipment constituting the system.
8. The Contractor shall take all necessary precautions to preclude the accidental discharge of fuel, oil, or other contaminants in order to prevent adverse effects on groundwater quality.

1.05 TESTING AND INSPECTION SERVICE

- A. The County will provide a geotechnical testing and inspection service. The services include testing soil materials and quality control testing during filling and backfilling operations. Samples of soil materials shall be furnished to the testing service by the Contractor. The County shall pay costs of initial geotechnical testing. The Contractor shall pay for any subsequent testing required due to failure and laboratory stand-by charges incurred.
- B. The Contractor shall provide monthly density testing reports to the County during backfilling activities. Density testing reports not submitted in a timely manner shall result in rejection of the pipe installed and rejection of the density testing reports until such time that density re-testing is coordinated and repeated at the Contractors expense.
- C. Density testing scheduled subsequent to backfilling activities shall be coordinated with, and witnessed by the County. Failure by the Contractor to coordinate or have the County present shall result in rejection of the submitted density testing reports and re-testing at the Contractor's expense.
- D. Dewatering systems shall not be removed until compaction/density testing has been completed.

PART 2 - PRODUCTS

2.01 MATERIALS

- A. General:
 - 1. All fill material shall be subject to the review and acceptance of the County.
 - 2. All fill material shall be free of organic material, trash, or other objectionable material. The Contractor shall remove excess or unsuitable material from the job site.
- B. Common Fill Material: Common fill shall consist of mineral soil, substantially free of clay, organic material, muck, loam, wood, trash, and other objectionable material which may be compressible or which cannot be compacted properly. Common fill shall not contain stones larger than 3-1/2-inches in any dimension in the top 12-inches or 6-inches in any dimension in the balance of fill area. Common fill shall not contain asphalt, broken concrete, masonry, rubble or other similar materials. It shall have physical properties that allow it to be easily spread and compacted during filling. Additional common fill shall be no more than 12 % by weight finer than the No. 200 mesh sieve, unless finer material is approved for use in a specific location by the County. Select Common Fill shall be as specified as above from common fill, except that the material shall contain no stones larger than 1/2-inches in largest dimension, and shall be no more than 5 % by weight finer than the No. 200 mesh sieve.

C. Structural Fill: Structural fill shall be reasonably well graded sand to gravelly sand having the following gradation:

US Sieve Size	Percent Passing By Weight
No. 1	100
No. 4	75 - 100
No. 40	15 - 80
No. 100	0 - 30
No. 200	0 - 12

D. Class 1 Soils*: Manufactured angular, granular material, 1/4 to 1-1/2-inches (6 to 4 mm) size, including materials having significance such as crushed stone or rock, broken coral, crushed slag, cinders, or crushed shells. Sieve analysis for crushed stone is given below separately.

Crushed Stone: Crushed stone shall consist of clean mineral aggregate free from clay, loam or organic matter, conforming to ASTM C33 stone size No. 89 and with particle size limits as follows:

U.S. Sieve Size	% Passing By Weight
1/2	100
3/8	100
No. 4	20 - 25
No. 8	5 - 30
No. 16	0 - 10
No. 50	0 - 2

E. Class II Soils**:

1. GW: Well graded gravels and gravel-sand mixtures, little or no fines. Fifty percent or more retained on No. 4 sieve. More than 95 % retained on No. 200 sieve. Clean.
2. GP: Poorly graded gravels and gravel-sand mixtures, little or no fines. Fifty percent or more retained on No. 4 sieve. More than 95 % retained on No. 200 sieve. Clean.
3. SW: Well graded sands and gravelly sands, little or no fines. More than passes No. 4 sieve. More than 95 % retained on No. 200 sieve. Clean.
4. SP: Poorly graded sands and gravelly sands, little or no fines. More than 50 % passes No. 4 sieve. More than 95 % retained on No. 200 sieve. Clean.

*Soils defined as Class I materials are not defined in ASTM D2487.

**In accordance with ASTM D2487, less than 5 % pass No. 200 sieve.

- F. Coarse Sand: Sand shall consist of clean mineral aggregate with particle size limits as follows:

U.S. Sieve Size	Percent Passing By Weight
3/8	100
No. 10	85 – 100
No. 40	20 – 40
No. 200	0 - 12

- G. Other Material: All other material, not specifically described, but required for proper completion of the Work shall be selected by the Contractor and acceptable by the County.

PART 3 - EXECUTION

3.01 PREPARATION

- A. Clearing:
1. The construction areas shall be cleared of all obstructions and vegetation including large roots and undergrowth within 10-feet of the lines of the excavation.
 2. Strip and stockpile topsoil on the site at the location to be determined by the County.

3.02 EXCAVATION

- A. General: Excavations for roadways, structures, and utilities must be carefully executed in order to avoid interruption of utility service.
- B. Excavating for Roadways/Structures/Utilities:
1. Excavation shall be made to such dimensions as will give suitable room for building the foundations and the structures, for bracing and supporting, for pumping and draining, and for all other work required.
 - a. Excavation for precast or prefabricated structures shall be carried to an elevation 2-feet lower than the proposed outside bottom of the structure to provide space for the select backfill material. Prior to placing the select backfill, the excavation shall be measured by the County to verify that the excavation has been carried to the proper depth and is reasonably uniform over the area to be occupied by the structure.
 - b. Excavation for structures constructed or cast in place in dewatered excavations shall be carried down to the bottom of the structure where dewatering methods are such that a dry excavation bottom is exposed and the naturally occurring material at this elevation leveled and left ready to receive construction. Material disturbed below the founding elevation in dewatered excavations shall be replaced with Class B concrete.
 - c. Footings: Cast-in-place concrete footing sides shall be formed immediately after excavation.
 2. Immediately document the location, elevation, size, material type and function of all new subsurface installations, and utilities encountered during the course of construction.

3. Excavation equipment operators and other concerned parties shall be familiar with subsurface obstructions as shown on the Drawings and should anticipate the encounter of unknown obstructions during the course of the Work.
4. Encounters with subsurface obstructions shall be hand excavated.
5. Excavation and dewatering shall be accomplished by methods that preserve the undisturbed state of subgrade soils. Subgrade soils which become soft, loose, "quick" or otherwise unsatisfactory for support of structures as a result of inadequate dewatering or other construction methods shall be removed and replaced by crushed stone as required by the County at the Contractor's expense.
6. The bottom of excavations shall be rendered firm and dry before placing any piping or structure.
7. All pavements shall be cut with saws or approved power tools prior to removal.
8. Excavated material shall be stockpiled in such a manner as to prevent nuisance conditions. Surface drainage shall not be hindered. Excavated material not suitable for backfill shall be removed from the site and disposed of by the Contractor.

3.03 DRAINAGE

- A. The Contractor shall at all times during construction provide and maintain proper equipment and facilities to remove promptly and dispose of properly all water entering excavations, and keep such excavations dry so as to obtain a satisfactory undisturbed subgrade foundation condition. The dewatering method used shall prevent disturbance of earth below grade.
- B. All water pumped or drained from the Work shall be disposed of in a suitable manner without undue interference with other work, without damage to surrounding property, and in accordance with pertinent rules and regulations.
- C. No construction, including pipe laying, shall be allowed in water. No water shall be allowed to contact masonry or concrete within 24-hours after being placed. The Contractor shall constantly guard against damage due to water and take full responsibility for all damage resulting from his failure to do so.
- D. The Contractor will be required at his expense to excavate below grade and refill with crushed stone (gradation 57 or 89) or other acceptable fill material if the County determines that adequate dewatering has not been provided.

3.04 UNDERCUT

- A. If the bottom of any excavation is below that shown on the Drawings or specified because of Contractor error, convenience, or unsuitable subgrade due the Contractor's excavation methods, he shall refill to normal grade with fill at his own cost. Fill material and compaction method shall be approved by the County.

3.05 FILL AND COMPACTION

- A. Compact and backfill excavations and construct embankment according to the following schedule. (Modified Proctor standard shall be ASTM D-1557):

STRUCTURES AND ROADWORK

Area	Material	Compaction
Beneath Structures	Structural Fill	12-inch lifts, compacted to 98% maximum density as determined by AASHTO T-180. Fill Should not be placed over any in-place soils until those deposits have been compacted to 98% Modified Proctor.
Around Structures	Structural Fill	12-inch lifts, 95% of maximum density as determined by AASHTO T-180. Rubber Tire or vibratory plate compactors shall be used
Beneath Paved Surfaces	Common Fill	12-inch lifts, 98% by maximum density as determined by AASHTO T-180 or as required by the FDOT Standards.
Open Areas	Common Fill	12-inch lifts, 95% by maximum density as determined by AASHTO T-180.

- B. Pipe shall be laid in open trenches unless otherwise indicated on the Drawings or elsewhere in the Contract Documents.
- C. Excavations shall be backfilled to the original grade or as indicated on the Drawings. Deviation from this grade because of settling shall be corrected. The backfill operation shall be performed to comply with all rules and regulations and in such a manner that it does not create a nuisance or safety hazard.
- D. Embankments shall be constructed true to lines, grades, and cross sections shown on the plans or ordered by the County. Embankments shall be placed in successive layers of not more than 8-inches in thickness, loose measure, for the full width of the embankment. As far as practicable, traffic over the Work during the construction phase shall be distributed so as to cover the maximum surface area of each layer.
- E. If the Contractor requests approval to backfill material utilizing lifts and/or methods other than those specified herein, such request shall be in writing to the County. Acceptance will be considered only after the Contractor has performed tests, at the Contractor's expense, to identify the material used and density achieved throughout the backfill area utilizing the method of backfill requested. The County's acceptance shall be in writing.
- F. One compaction test location shall be required for each 300 linear feet of pipe and for every 100 square feet of backfill around structures as a minimum. The County may determine that more compaction tests are required to certify the installation depending on field conditions. The locations of the compaction tests within the trench shall be in conformance with the following schedule:
1. At least one test at the spring line of the pipe.

2. At least one test for each 12-inch layer of backfill within the pipe bedding zone for pipes 24-inches and larger.
3. One test at an elevation of 1-foot above the top of pipe.
4. One test for each 2-feet of backfill placed from 1-foot above the top of the pipe to finished grade elevation.
5. Density testing is required for sanitary sewer manholes. Tests shall be staggered around the manhole within 3-feet of the structure's outside diameter.
 - a. First test shall be 1-foot above the structure base.
 - b. Second test shall be 2-feet above the first test and subsequent tests every 2-feet up the finished grade.
6. The Contractor shall provide additional compaction and testing prior to commencing further construction if the County's testing reports and inspection indicate that the fill has been placed below specified density.
7. The Contractor shall coordinate testing with the County approved testing laboratory and shall provide monthly test results to the County in a timely manner during construction activities. Density testing scheduled subsequent to backfilling activities shall be coordinated with the County and witnessed by the County representative. Failure by the Contractor to coordinate or have the County representative present shall result in rejection of the submitted density testing reports and re-testing at the Contractor's expense. Density testing reports not submitted in a timely manner shall result in rejection of the pipe installed and rejection of the density testing reports until such time that density re-testing is coordinated and repeated at the Contractor's expense as deemed necessary by the County's representative.
8. Dewatering systems shall not be removed until compaction/density testing has been completed.

END OF SECTION

SECTION 02576
CONCRETE SIDEWALKS AND DRIVEWAYS

PART 1 - GENERAL

1.01 DESCRIPTION

- A. Scope of Work: Constructing new concrete sidewalks, driveways, and curb and gutters as shown on the Drawings.

1.02 QUALITY ASSURANCE

- A. Codes and Standards: Comply with applicable sections of F.D.O.T. Specifications and local governing regulations.
- B. The mixture, placement, and curing of all concrete work shall be in accordance with F.D.O.T. Specifications.

1.03 SHOP DRAWINGS AND SUBMITTALS

- A. Submittals shall be submitted to the County for review and acceptance prior to construction in accordance with the General Conditions and specifications Section 01300 "Submittals."
- B. Furnish manufacturer's product data, design mixes, test reports, and materials certifications.

1.04 JOB CONDITIONS

- A. Traffic Control: Maintain access for vehicular and pedestrian traffic as required for other construction activities, as specified under Section 01570 "Maintenance of Traffic."
- B. Utilize flagman, barricades, warning signs, and warning lights as required.

1.05 GUARANTEE

- A. All restored areas within the public right-of-way shall be guaranteed for 1-year after final acceptance. In the event of cracked or broken concrete surfaces, the Contractor shall make the necessary repairs to restore the concrete within 10-calendar days after notification by the County. The cost of such repairs shall be paid by the Contractor.

PART 2 - PRODUCTS

2.01 GENERAL

- A. All material supplied shall be one of the products specified in Appendix D "List of Approved Products" appended to these technical specifications.

2.02 CONCRETE MATERIALS

- A. Forms: Steel or wood for each type of use of size and strength to resist movement during concrete placement and to retain horizontal and vertical alignment until removal. Use straight forms, free of distortion and defects.
 - 1. Use flexible spring steel forms or laminated boards to form radius bends as required.
 - 2. Coat forms with a non-staining form release agent that will not discolor or deface the surface of the concrete.
- B. Fibermesh Reinforcement: Fibermesh reinforcement fibers shall be 2-inches to 3-inches collated polypropylene fibers. Fibers shall be in strict accordance with the manufacturer recommendations and within the time as specified in ASTM C94, Type III 4.13 and applicable building codes.
- C. Concrete Materials: Comply with requirements of F.D.O.T. Section 347 for concrete materials, admixtures, bonding materials, curing materials, and others as required.
- D. Epoxy Resin Grout: Type N as specified in F.D.O.T. Section 926.
- E. Aggregate, brick, or other material required to match existing driveway or walk shall be as approved by the County.

2.03 CONCRETE MIX, DESIGN, AND TESTING

- A. Comply with requirements of applicable F.D.O.T. Section 347 for concrete mix design, sampling and testing, and quality control, and as herein specified.
- B. Design the mix to produce standard weight concrete consisting of Portland cement, aggregate, air entraining admixture, and water to produce the following properties.
 - 1. Compressive Strength: Class B, 3,000 psi for walks and curbs.
 - 2. Compressive Strength: Class A, 4,000 psi for driveways.
 - 3. Air Content: 3% to 6% .
- C. Concrete slump shall not exceed plus or minus 1-inch from approved design slump.

PART 3 - EXECUTION

3.01 CONCRETE SIDEWALK, DRIVEWAY, AND CURB AND GUTTER

A. Surface Preparation:

1. Remove loose material from the compacted sub base surface immediately before placing concrete.
2. Proof-roll prepared sub base surface to check for unstable areas and the need for additional compaction. Do not begin paving work until such conditions have been corrected and are ready to receive paving.

B. Form Construction:

1. Set forms to the required grades and lines, rigidly braced and secured. Install sufficient quantity of forms to allow continuous progress of the Work and so that forms can remain in place at least 24-hours after concrete placement.
2. Check completed form work for grade alignment to the following tolerances:
 - a. Top of forms not more than 1/8-inch in 10-feet.
 - b. Vertical face on longitudinal axis, not more than 1/4-inch in 10-feet.
3. Clean forms for reuse immediately after use, and coat with form release agent as often as required to ensure separation from concrete without damage.

C. Concrete Placement:

1. Do not place concrete until sub base and forms have been checked for line and grade. Moisten if required to provide a uniform dampened condition at the time concrete is placed. Do not place concrete around manholes or other structures until they are completed to required finish elevation and alignment. Use special colors or aggregate as required to match existing material.
2. Place concrete using methods which prevent segregation of the mix. Consolidate concrete along the face of forms and adjacent to transverse joints with an internal vibrator. Keep vibrator away from joint assemblies, reinforcement, or side forms. Use only square-faced shovels for hand spreading and consolidation. Consolidate with care to prevent dislocation of reinforcing, dowels, and joint devices. Do not use vibrators to push or move concrete in forms or chute.
3. Deposit and spread concrete in a continuous operation between transverse joints, as far as possible. If interrupted for more than 1/2-hour, place a construction joint.
4. An automatic machine may be used for sidewalk or curb and gutter placement at Contractor's option. If machine placement is to be used, submit revised mix design and laboratory test results which meet or exceed the minimum herein specified. Machine placement must produce sidewalks and/or curbs and gutters to the required cross-section, lines, grades, finish, and jointing as specified for formed concrete. If results are not acceptable, remove and replace with formed concrete as specified.

5. Joints: Construct expansion, weakened-plane (contraction), and construction joints true-to-line with face perpendicular to surface of the concrete, unless otherwise indicated. Construct transverse joints at right angles to the centerline, unless otherwise indicated. When joining existing structures place transverse joints to align with previously placed joints, unless otherwise indicated.
 - a. Weakened-Plane Joints: Provide weakened-plane (contraction) joints sectioning concrete into areas as shown on the Drawings. Construct weakened plane joints for a depth equal to at least 1/4 concrete thickness, by sawing within 24-hours of placement or formed during finishing operations. Place joints at intervals not to exceed 10-feet if not otherwise indicated.
 - b. Construction Joints: Place construction joints at the end of all pours and at locations where placement operations are stopped for a period of more than 1/2-hour, except where such pours terminate at expansion joints. Construction joints shall be as shown or, if not shown, use standard metal keyway-section form of appropriate height.
 - c. Expansion Joints:
 - (1) Provide premolded joint filler for expansion joints abutting concrete curbs, catch basin, manholes, inlets, structures, walks, and other fixed objects, unless otherwise indicated.
 - (2) Locate expansion joints at 12-feet on center for concrete walks unless otherwise indicated.
 - (3) Extend joint fillers full-width and depth of joint, and not less than 1/2-inch below finished surface where joint sealer is indicated. If no joint sealer, place top of joint filler flush with finished concrete surface.
 - (4) Furnish joint fillers in one-piece lengths for the full width being placed, wherever possible. Where more than one length is required, lace or clip joint filler sections together. Pieces shorter than 4-inches shall not be used unless specifically shown as such.
 - (5) Protect the top edge of the joint filler during concrete placement with a metal cap or other temporary material. Remove protection after concrete has been placed on both sides of joint.
 - (6) Fillers and Sealants: Comply with the requirements of these specifications for preparation of joints, materials installation, and performance, and as herein specified.

D. Concrete Finishing:

1. After striking-off and consolidating concrete, smooth the surface by screening and floating. Use hand methods only where mechanical floating is not possible. Adjust the floating to compact the surface and produce a uniform texture.
2. After floating, test surface for trueness with a 20-foot straightedge. Variations exceeding 1/3-inch for any two points within 10-feet shall not be acceptable. Distribute concrete as required to remove surface irregularities, and refloat repaired areas to provide a continuous smooth finish.
3. Work edges of slabs, gutters, back top edge of curb, and formed joints with an edging tool, and round 10-1/2-inch radius, unless otherwise indicated. Eliminate any tool marks on concrete surface.

4. After completion of floating and when excess moisture or surface sheen has disappeared, broom finish sidewalks by drawing a fine-hair broom across concrete surface, perpendicular to a line of pedestrian traffic. If the existing material has another finish, match existing finish.
5. Do not remove forms for 24-hours after concrete has been placed. After form removal, clean ends of joints and point up any minor honeycombed areas.

E. Curing:

Protect and cure finished concrete paving and walks, complying with applicable requirements of F.D.O.T. Section 350. Use moist-curing methods for initial curing of approved concrete curing compounds whenever possible.

F. Repairs and Protections:

1. Repair or replace broken or defective concrete, as directed by the County.
2. Drill test cores where directed by the County, when necessary to determine magnitude of cracks or defective areas. Fill drilled core holes in satisfactory pavement areas with Portland cement concrete bonded to pavement with epoxy resin grout.
3. Protect concrete from damage until acceptance of work. When construction traffic is permitted, maintain pavement as clean as possible by removing surface stains and spillage of materials as they occur.
4. Sweep concrete pavement and wash free of stains and discolorations, dirt, and other foreign material just prior to final inspection.

3.02 FIELD QUALITY CONTROL

- A. General: Repair or remove and replace unacceptable concrete sidewalk, driveways, or curb and gutter as directed by the County.
- B. Surface Elevation: Actual surface elevations shall be within ± 0.05 feet of specified or indicated elevations at any given point. Surface elevations between any 2 given points shall be interpolated from a direct line between the 2 points. Surfaces exceeding actual elevation tolerances of more than ± 0.05 feet at any 2 points within a distance of 15-feet will not be acceptable.

END OF SECTION

1

THIS PAGE LEFT BLANK INTENTIONALLY

SECTION 02578
SOLID SODDING

PART 1 - GENERAL

1.01 DESCRIPTION

- A. Scope of Work: Establishing a stand of grass by furnishing and placing grass sod. Included are fertilizing, watering, and maintenance as required to assure a healthy stand of grass. Solid sodding shall be placed on all slopes greater than 4:1, within 10-feet of all proposed structures, and in all areas where existing grass or sod (regardless of it's condition) is removed or disturbed by Contractor's operation unless otherwise specified or shown on the Drawings.

1.02 SHOP DRAWINGS AND SUBMITTALS

- A. Submittals shall be submitted to the County for review and acceptance prior to construction in accordance with the General Conditions and specifications Section 01300 "Submittals."
 - 1. A certification of sod quality by the producer shall be delivered to the County ten days prior to use.

PART 2 - PRODUCTS

2.01 GENERAL

- A. All material supplied shall be one of the products specified in Appendix D "List of Approved Products" appended to these technical specifications.

2.02 GRASS SOD

- A. Grass sod for the road rights-of-way shall be of variety to match the existing adjacent area and shall be well matted with grass roots. The sod shall be taken up in rectangles, preferably 12-inch by 24-inch, shall be a minimum of 2-inches in thickness, and shall be live, fresh, and uninjured at the time of planting.
- B. Grass sod for restoration of new construction sites and/or areas disturbed by construction on existing sites shall be St. Augustine well matted with grass roots. The sod shall be taken up in rectangles, preferably 12-inch by 24-inch, shall be a minimum of 2-inches in thickness, and shall be live, fresh, and uninjured at the time of planting.

- C. It shall be reasonably free of weeds and other grasses and shall have a soil mat of sufficient thickness adhering firmly to the roots to withstand all necessary handling. The sod shall be planted as soon as possible after being dug and shall be shaded and kept moist until it is planted.

2.03 FERTILIZER

- A. Commercial fertilizers shall comply with the state fertilizer laws.
- B. The numerical designations for fertilizer indicate the minimum percentages (respectively) of (1) total nitrogen, (2) available phosphoric acid, and (3) water-soluble potash contained in the fertilizer.
- C. The chemical designation of the fertilizer shall be 6-6-6. At least 50% of the nitrogen shall be derived from organic sources. At least 50 % of the phosphoric acid shall be from normal super phosphate or an equivalent source, which will provide a minimum of two units of sulfur. The amount of sulfur shall be indicated on the quantitative analysis card attached to each bag or other container.

2.04 WATER FOR GRASSING

- A. The water used in the sodding operations shall be by the Contractor as approved by the County.

PART 3 - EXECUTION

3.01 PREPARATION OF GROUND

- A. The area over which the sod is to be placed shall be scarified or loosened to a depth and then raked smooth and free from debris. Where the soil is sufficiently loose and clean, the County, at its discretion, may authorize the elimination of ground preparation.

3.02 APPLICATION OF FERTILIZER

- A. Before applying fertilizer, the soil pH shall be brought to a range of 6.0 - 7.0.
- B. The fertilizer shall be spread uniformly over the area to be sodded at the rate of 700-pounds per acre, or 16-pounds per 1,000 square feet, by a spreading device capable of uniformly distributing the material at the specified rate. Immediately after spreading, the fertilizer shall be mixed with the soil to a depth of approximately 4-inches.
- C. On steep slopes, where the use of a machine for spreading or mixing is not practicable, the fertilizer shall be spread by hand and raked in and thoroughly mixed with the soil to a depth of approximately 2-inches.

3.03 PLACING SOD

- A. The sod shall be placed on the prepared surface, with edges in close contact and shall be firmly and smoothly embedded by light tamping with appropriate tools.
- B. Where sodding is used in drainage ditches, or on slopes of 4:1 or greater, the setting of the pieces shall be staggered to avoid a continuous seam along the line of flow. Along the edges of such staggered areas, the offsets of individual strips shall not exceed 6-inches. In order to prevent erosion caused by vertical edges at the outer limits, the outer pieces of sod shall be tamped so as to produce a featheredge effect.
- C. On slopes greater than 2:1, the Contractor shall, if necessary, prevent the sod from sliding by means of wooden pegs driven through the sod blocks into firm earth at suitable intervals.
- D. Sod which has been cut for more than 72-hours shall not be used unless specifically authorized by the County after the inspection thereof. Sod which is not planted within 24-hours after cutting shall be stacked in an approved manner, maintained, and properly moistened. Any pieces of sod that, after placing, show an appearance of extreme dryness shall be removed and replaced by fresh, uninjured pieces.
- E. Sodding shall not be performed when weather and soil conditions are, in the County's opinion, unsuitable for proper results.

3.04 WATERING

- A. The areas on which the sod is to be placed shall contain sufficient moisture, as determined by the County, for optimum results. After being placed, the sod shall be kept in a moist condition to the full depth of the rooting zone for at least 2-weeks. Thereafter, the Contractor shall apply water as needed until the sod roots and starts to grow for a minimum of 60-days (or until final acceptance, whichever is latest).

3.05 MAINTENANCE

- A. The Contractor shall maintain, at his expense, the sodded areas in a satisfactory condition until final acceptance of the Project. Such maintenance shall include repairing of any damaged areas and replacing areas in which the establishment of the grass stand does not appear to be developing satisfactorily.
- B. Replanting or repair necessary due to the Contractor's negligence, carelessness, or failure to provide routine maintenance shall be at the Contractor's expense.

END OF SECTION

1

THIS PAGE LEFT BLANK INTENTIONALLY

SECTION 02661
WASTEWATER FORCE MAINS

PART 1 - GENERAL

1.01 WORK INCLUDED

- A. The work under this Section includes providing a complete system for wastewater transmission pressure piping and appurtenant items.

1.02 QUALITY ASSURANCE

A. Design Requirements

1. Piping shall be laid with a minimum cover of 36-inches below finished grade, unless otherwise indicated.
2. Pipelines shall be constructed of the materials indicated on the Drawings.
3. All force mains shall be installed with a continuous insulated 10-gauge copper wire. Wire shall terminate at the top of each valve and be capable of extending 18-inches above the top of the box.
4. All PVC force mains shall be solid green. All lettering shall appear legibly on the pipe and shall run the entire length of the pipe. Lettering shall read as is acceptable for the intended use.
5. Flanged ductile iron used in valve vaults or above ground piping at pump stations shall be Protecto 401 lined and coated per specification Section 09901, "Coatings and Linings." Flanged DIP shall be epoxy coated from the factory and shall not be coated with bitumastic or asphaltic exterior coatings.

- B. Pipe Inspection: The Contractor shall obtain from the pipe manufacturers a certificate of inspection to the effect that the pipe and fittings supplied for this contract have been inspected at the plant and that they meet the requirements of these specifications. All pipe and fittings shall be subjected to visual inspection at time of delivery and just before they are lowered into the trench to be laid. Joints or fittings that do not conform to these specifications will be rejected and must be removed immediately by the Contractor. The entire product of any plant may be rejected when, in the opinion of the County, the methods of manufacture fail to secure uniform results, or where the materials used produce inferior pipe or fittings.

- C. Prevention of Electrolysis: Where shown on Drawings or deemed necessary, electrolytic action through the contact of dissimilar metals shall be prevented by either;

1. The separation of one material from the other by means of an insulating or dielectric coupling (polyethylene wrap), or
2. The use of alternative materials, as directed by the County

1.03 SHOP DRAWINGS AND SUBMITTALS

- A. Submittals shall be submitted to the County for review and acceptance prior to construction in accordance with the General Conditions and specifications Section 01300 "Submittals."
 - 1. Certified test reports on pipe
 - 2. Details of restrained and flexible joints
 - 3. Detailed laying schedule for pipe
 - 4. Valves and valve boxes
- B. Acceptance of Material: The County reserves the right to sample and test any pipe or fitting after delivery and to reject all pipe and fittings represented by any sample which fails to comply with the specified requirements.

1.04 JOB CONDITIONS

- A. Water in Excavation: Water shall not be allowed in the trenches while the pipes are being laid and/or tested. The Contractor shall not open more trenches than the available pumping facilities are able to dewater to the satisfaction of the County. The Contractor shall assume responsibility for disposing of all water so as not to injure or interfere with the normal drainage of the territory in which he is working. In no case shall the pipelines being installed be used as drains for such water, and the ends of the pipe shall be kept properly and adequately blocked during construction by the use of acceptable stoppers and not by improvised equipment. All necessary precautions shall be taken to prevent the entrance of mud, sand, or other obstructing matter into the pipelines. If on completion of the Work any such material has entered the pipelines, it must be cleaned as directed by the County so that the entire system will be left clean and unobstructed.

PART 2 - PRODUCTS

2.01 GENERAL

- A. All material supplied shall be one of the products specified in Appendix D "List of Approved Products" appended to these technical specifications.

2.02 MATERIALS

- A. Pipe Fittings, Valves, and Ancillary Equipment shall be installed as shown on the Drawings and as specified in Division 15.
- B. Additional Work: Additional items of construction, necessary for the complete installation of the systems, shall conform to specific details shown on the Drawings and shall be constructed of first-class materials conforming to the applicable portions of these specifications.

PART 3 - EXECUTION

3.01 PREPARATION

- A. Bedding: Upon satisfactory installation of the pipe bedding material as specified in Section 02220 "Excavating, Backfilling and Compacting", a continuous trough for the pipe barrel and recesses for the pipe bells or couplings shall be excavated by hand digging. The pipe shall be laid in the prepared trench, true to line and grade, the pipe barrel shall receive continuous, uniform support and no pressure will be exerted on the pipe joints from the trench bottom.
- B. Cleanliness: The interior of the pipes shall be thoroughly cleaned of all foreign matter before being gently lowered into the trench and shall be kept clean during laying operations by means of plugs or other methods acceptable by the County. During suspension of work for any reason at any time, a suitable stopper shall be placed in the end of the pipe last laid to prevent mud or other foreign material from entering the pipe.

3.02 INSTALLATION

- A. Pipe Identification/Location
 - 1. All PVC wastewater mains shall be solid green in color. All lettering shall appear legibly on the pipe and shall run the entire length of the pipe. Lettering shall read as is acceptable for the intended use.
 - 2. All HDPE wastewater mains shall be either a solid green or black with four co-extruded equally spaced green stripes of the same material as the pipe. Stripes painted on the pipe outside surface shall not be acceptable.
 - 3. If main is located over 30-feet from the edge of the pavement or in an easement, the Contractor shall install 4-inch diameter schedule 80 PVC utility pipe line markers over the pipe alignment at 1,000-foot intervals, at all valves, and at all locations where fittings deflect the pipe alignment in the horizontal plane. Utility pipeline markers shall include a decal and shall be colored purple for reclaimed water service.
 - 4. All mains (PVC and HDPE) shall be installed with a continuous, insulated 10-gauge copper wire installed directly above the pipe for location purposes. Locate wire shall terminate in a test station box and be capable of extending 12-inches above the top of the box. Directionally drilled pipe shall be installed with two insulated 10-gauge copper wires.
- B. Pipe:
 - 1. Gradient: Lines shall be laid straight, and depth of cover shall vary to provide uniform gradient or slope to pipe, whether grading is completed or proposed at time of pipe installation. When a grade or slope is shown on the Drawings, batter boards with string line paralleling design grade, or other previously approved means, shall be used by the Contractor to assure conformance to required grade.

2. Pipe Joint Deflection: No joint deflection or pipe bending is allowed in PVC pipe. The maximum allowable tolerance in the joint due to variances in installation is 0.75° (degrees), (3-inches per joint per 20-ft stick of pipe). No bending tolerance in the pipe barrel shall be acceptable. Alignment changes shall be made with sleeves and fittings as shown in Drawings. Deflection in fittings and sleeves shall not exceed 75% of the limits recommended by the fitting manufacturer.
3. Rejects: Any pipe found defective shall be immediately removed from the site and replaced with sound pipe at the Contractor's expense.
4. Joint Compounds: No sulfur base joint compound shall be used.
5. Thrust restraints shall be accomplished by the use of mechanical restraining devices unless specifically identified otherwise on the Drawings or herein. Restraining devices are specified in Section 15064 "Polyvinyl Chlorine Pipe and Fittings", respectfully.

C. Installing Valves and Boxes

1. Valves: Valves shall be carefully inspected, opened wide and then tightly closed and the various nuts and bolts shall be tested for tightness. Plug valves shall have the disc shaft installed horizontally with the plug rotating upward to the top of the valve. Any valve that does not operate correctly shall be removed and replaced.
2. Valve Boxes: Valve boxes and riser shall be centered over the operating nuts of the valves with a centering ring or disc so as to permit a valve key to be fitted easily to the operating nut. In unpaved areas, valve boxes shall be set to conform to the level of the finished surface and held in position by a concrete collar placed under the support flange as shown on the Drawings. The valve box shall not transmit surface loads to the pipe or valve. Extensions or risers for valve boxes shall be an integral part of the box. No cut sections of D.I. or PVC pipe shall be used in extending the box to its proper height. Care shall be taken to prevent earth and other material from entering the valve box. Any valve box which is out of alignment or whose top does not conform to the finished ground surface shall be dug out and reset. Before final acceptance of the Work all valve boxes shall be adjusted to finish grade.

D. Concrete Encasement

1. Concrete encasement shall be constructed in accordance with details shown on the Drawings and shall be constructed of Class C concrete. Encasement shall be constructed where
 - a. As indicated on the Drawings
 - b. As directed by the County
2. The points of beginning and ending of pipe encasement shall be not more than 6-inches from a pipe joint to protect the pipe from cracking due to uneven settlement of its foundation or the effects of superimposed live loads.
3. Concrete Collar: Each valve installed in an unimproved area (outside of pavement, driveways or sidewalks) shall require a 24-inch x 24-inch x 6-inch concrete pad or collar as shown in the Drawings.

- E. Flush Out Connections: Flush out connections shall be installed at the locations as determined by the County and be full pipe size to accommodate a full diameter flush for pipes 12-inches and smaller or a swab for pipes greater than 12-inches.

- F. Backfilling: Backfilling shall be in accordance with Section 02220 "Excavating, Backfilling and Compacting" of these specifications.

3.03 CLEANING

- A. General: At the conclusion of the Work the Contractor shall thoroughly clean the new pipe lines by flushing with water or other means to remove all dirt, stones or other material which may have entered the line during the construction period.
- B. Flushing 12-inch pipes and less: Flushing to remove all sand and other foreign matter from pipelines shall only be permitted for mains 12-inches and smaller. Flushing shall be accomplished through full pipe size connections at full pipe depth. The velocity of the flushing water shall be at least 4-feet per second. Flushing shall be terminated at the direction of the County. The Contractor shall dispose of the flushing water without causing a nuisance or property damage. The Contractor shall arrange and pay for the source of flushing water with the County or others.
- C. Swabbing in lieu of flushing: New mains may be hydraulically or pneumatically cleaned with a polypropylene swabbing device to remove dirt, sand and debris from main. If swabbing access and egress points are not provided in the design drawings, it will be the responsibility of the Contractor to provide temporary access and egress points for the cleaning, as required. Passage of cleaning poly swabs through the system shall be constantly monitored, controlled and all poly swabs entered into the system shall be individually marked and identified so that the exiting of the poly swabs from the system can be confirmed. Cleaning of the system shall be done in conjunction with the initial filling of the system for its hydrostatic test. After initial slow-fill, pipe shall sit full for 24 hours to facilitate cleaning and collection of debris from interior of pipe. The Contractor shall insert flexible polyurethane foam swabs (2-pounds per cubic foot density) complete with rear polyurethane drive seal, into the first section of pipe. The swabs shall remain there until the pipeline construction is completed. The line to be cleaned shall only be connected to the existing distribution system at a single connection point. Locate and open all new in-line valves beyond the point of connection on the pipeline to be cleaned during the swabbing operation. At the receiver or exit point for the poly swab, the Contractor is responsible for creating a safe environment for collection of debris, water and the swab. Considerations shall be made for protecting surrounding personnel and property and safe retrieval of the swab. Only County personnel shall operate the supply valve from the existing distribution system. Cleaning and flushing shall be accomplished by propelling the swab down the pipeline to the exit point with potable water. Flushing shall continue until the water is completely clear and swab is retrieved.

3.04 FIELD QUALITY CONTROL

- A. Correction of Non-Conforming Work: All non-conforming work shall be repaired or replaced by the Contractor at no additional expense to the County. Non-conforming work shall be defined as failure to adhere to any specific or implied directive of this Project Manual and/or the Drawings, including but not limited to pipe not laid true to the lines and grades as shown on the Drawings, damaged or unacceptable materials, misalignment or diameter ring deflection in pipe due to bedding or backfilling, visible or detectable leakage and failure to pass any specified test or inspection.
- B. Pressure and Leakage Tests of Pressure Piping
1. General: The Contractor shall perform hydrostatic pressure and leakage tests on all pressure piping. Tests shall be conducted on segments between valves and no more than 2,000 linear feet is to be tested at one time unless otherwise acceptable by the County.
 2. Standard: AWWA C600, Section 5 (DI pipe) and AWWA C605 Section 7 (PVC pipe) with the exceptions required herein and the exception that the Contractor shall furnish all gauges, meters, pressure pumps and other equipment needed to test the lines.
 3. Hydrostatic Pressure Test
 - a. Test Pressure: Test pressure will be 50% above the normal working pressure, but not less than 100-psi, unless otherwise noted on the Drawings.
 - b. Test Duration: Test shall be for a period of 2-hours. If during the test, the integrity of the tested line is in question, the County may require a 6-hour pressure test.
 - c. Air Release: Corporation cocks at least 3/4-inch in diameter, pipe riser and angle globe valves shall be provided at each dead-end to bleed air from the line.
 4. Hydrostatic Leakage Test
 - a. General: Following the pressure test, the Contractor shall perform the leakage test. The line shall be filled with water and all air removed for the test. The Contractor shall provide a pump to maintain the test pressure for the entire test period.
 - b. Test Pressure: Maximum operating pressure as determined by the County but not less than 100-psi unless otherwise noted.
 - c. Test duration: 2-hours.
 - d. Allowable leakage:
$$L = \frac{SD(P)^{0.5}}{148,000}$$

L = Allowable leakage (gallons per hour)
S = Length of pipe tested (feet)
D = Nominal diameter of pipe (inches)
P = Average test pressure maintained (psig)
 - e. Visible Leakage: All leaks evident at the surface shall be repaired and leakage eliminated regardless of the measured total leakage.
 - f. Leakage Measurement: The amount of water required to maintain the test pressure is the leakage.

END OF SECTION

SECTION 02761
CLEANING SANITARY SEWER SYSTEMS

PART 1 - GENERAL

1.01 SCOPE OF WORK

- A. The Work covered in this section consists of cleaning sewer lines and manholes prior to the internal television inspection(s) for new or existing wastewater systems.
- B. Gravity Main and Sewer Lateral Cleaning: The intent of gravity main cleaning is to remove debris that may be causing a reduction in flow capacity, potential sewer backups, or that limits the ability to evaluate the structural condition of the pipe segment. On all sewers, the Contractor shall perform sewer-cleaning work to an acceptable level as necessary to perform a thorough television inspection of the sewer. An acceptable level is defined as the removal of all debris throughout the pipe segment cleaned. If the pipe condition is such that cleaning may cause a potential collapse, then the pipe shall be televised without attempting to clean it pending approval by the County.
- C. Water for Cleaning: The Contractor will be responsible for obtaining a transient water meter and paying for water used during course of cleaning.
- D. Recovering of Equipment: The Contractor will be responsible for recovering any equipment that becomes lodged or lost in the pipeline. The Contractor will be responsible for all costs associated with required evacuation, restoration of roads and easements, and repairs to pipes and manholes as needed to restore the pipeline and appurtenances back to their original conditions.

1.02 CLEANING EQUIPMENT

- A. Hydraulically Propelled Equipment: The equipment used shall be of a movable dam type and be constructed in such a way that a portion of the dam may be collapsed at any time during the cleaning operation to protect against flooding of the sewer. The movable dam shall be equal in diameter to the pipe being cleaned and shall provide a flexible scraper around the outer periphery for grease removal. Special precautions to prevent flooding of the sewers and public or private property shall be taken at all times.
- B. High-Velocity Jet (Hydro-Cleaning) Equipment: All high-velocity sanitary sewer cleaning equipment shall be constructed for ease and safety of operation. The equipment shall have a selection of 2 or more high-velocity nozzles. The nozzles shall be capable of producing a scouring action from 15° to 45° (degrees) in all size mains. Equipment shall also include a high-velocity gun for washing and scouring manhole walls and floor. The gun shall be capable of producing flows from a fine spray to a solid stream. The equipment shall carry its own water tanks, auxiliary engines, pumps, and hydraulically driven hose reel.

- C. Mechanically Powered Equipment: Bucket machines shall be in pairs with sufficient power to perform the Work in an efficient manner. Machines shall be belt operated or have an overload device. Machines with direct drive that could cause damage to the pipe will not be used. A power rodding machine shall be either a sectional or continuous rod type capable of holding a minimum of 750-feet of rod. The rod shall be heat-treated steel. To ensure safe operation, the machine shall be fully enclosed and have an automatic safety clutch or relief valve.
- D. Vacuum machines may be used for removal of materials from manholes when other cleaning equipment is used to dislodge and transport material to the access point.
- E. Combination Cleaner: For cleaning small and large diameter sewer, the Contractor may use a combination hydraulic high volume water and solids separation system. Water volume of up to 250-gpm at or above 2,000-psi will move solids to the downstream manhole in high flow conditions. The separation system will dewater solids to 95 % (passing a paint filter test) and transfer them to a dump truck, if needed, for transport to a water reclamation facility, approved landfill, or other location specified by the County or designee. Wash water will be filtered to a point where it can be used in the pump for continuous cleaning. No bypassing of sewer flows will be necessary. The unit shall be capable of 24-hour operation and the unit shall not leave the manhole until a section is fully cleaned.

1.03 SHOP DRAWINGS AND SUBMITTALS

- A. Submittals shall be submitted to the County for review and acceptance prior to construction in accordance with the General Conditions and specifications Section 01300 "Submittals."
- B. A daily log shall be maintained to record the location of the manholes and sewer lines, lengths of the lines cleaned, method of cleaning, line sizes, identify type of cleaning (light, medium, or heavy), and type of debris moved. Observations are to be recorded on a cleaning report form.

PART 2 - PRODUCTS (NOT USED)

PART 3 - EXECUTION

3.01 GENERAL

- A. All material supplied shall be one of the products specified in Appendix D "List of Approved Products" appended to these technical specifications.
- B. The equipment shall remove dirt, grease, rocks, sand, other materials, and obstructions from the sewer mains, laterals, and manholes.

- C. A high-velocity sewer cleaner will be used for the majority of the cleaning work. Other equipment, such as bucket machines, rod machines, hydraulic root cutters, vacuum trucks and balling equipment shall be available.

3.02 CLEANING PRECAUTIONS

- A. All necessary precautions shall be taken to protect the sewer from damage during all cleaning and preparation operations. Precautions shall also be taken to ensure that no damage is caused to public or private property adjacent to or served by the sewer or its branches. The Contractor shall pay for and restore, at no additional costs to the County, any damage caused to public or private property because of such cleaning and preparation operations.
- B. Satisfactory precautions shall be taken in the use of cleaning equipment. When hydraulically propelled cleaning tools (which depend upon water pressure to provide their cleaning force) or tools which retard the flow in the sewer line are used, precautions shall be taken to ensure that the water pressure created does not damage or cause flooding of public or private property being served by the sewer. No fire hydrant shall be obstructed in case of a fire in the area served by the hydrant. All requirements shall be met when accessing a fire hydrant including but not limited to meters, backflow preventers, and properly trained personnel. It shall be the Contractor's responsibility to meet all state and local requirements.

3.03 CLEANING

- A. If cleaning of an entire sewer section cannot be successfully performed from one manhole, the equipment shall be set up on the other manhole and cleaning attempted again. If results of the cleaning are favorable, the Contractor will proceed with the TV inspection. All sludge, dirt, sand, rocks, and other solid or semisolid materials resulting from the cleaning operation shall be removed from the downstream manhole of the section being cleaned. The Contractor shall not be responsible for removing mortar or other material that is securely attached to the pipe walls or joints.
- B. Materials shall be disposed of from the site at least once at the end of each workday. The Contractor will be responsible for the disposal of materials removed from the sewer system. All sewer-cleaning efforts shall require documentation of all quantities and types of materials removed during cleaning.
- C. The designated sewer manhole sections shall be cleaned using hydraulically propelled, high-velocity jet, or mechanically powered equipment approved by the County. Cleaning shall consist of normal hydraulic jet cleaning to facilitate the internal CCTV inspection.
 - 1. Types of cleaning of sanitary sewers:
 - a. Light cleaning of sewers consists of a maximum of 1 pass of the jet nozzle. Light cleaning of laterals will consist of flushing water into a cleanout.
 - b. Medium cleaning of sewers consists of 2 to 4 passes of the jet nozzle. Medium cleaning of laterals will consist of 1 to 4 passes with a jet nozzle.

- c. Heavy cleaning consists of 5 or more passes of the jet nozzle such as removing heavy grease, debris, and roots.
 - d. Descaling of Ductile Iron pipe: Multiple passes with mechanical equipment to remove scale build up to restore pipe to original inside diameter.
2. Selection of the equipment used shall be based on the conditions of lines at the time the Work commences. The equipment and methods selected shall be satisfactory to the County. The equipment shall be capable of removing dirt, grease, rocks, sand, debris, other materials, and obstructions from the sewer lines, laterals, and manholes.
 3. If cleaning of an entire section cannot be successfully performed from one manhole, the equipment shall be set up on the other manhole and cleaning again attempted. The intent of preparatory cleaning is to provide sufficient cleaning to ensure camera passage and the internal conditions of the pipeline can be fully assessed.
 4. If the County establishes that a particular section of the pipeline cannot be adequately cleaned due to broken, collapsed, or void areas, then the inspection will be attempted up to the obstruction.

3.04 ROOT REMOVAL

- A. Roots shall be removed in the designated sections and manholes where root intrusion is a problem and where authorized by the County. Special attention should be used during the cleaning operation to remove roots from the joints. Any roots that could prevent the proper application of chemical sealants, or could prevent the proper seating and application of cured-in-place liners shall be removed. Procedures may include the use of mechanical equipment such as, rodding machines, bucket machines, winches using root cutters, porcupines, and equipment such as high-velocity jet cleaners. Chemical root treatment shall be used before or following the root removal operation, depending on the manufacturer's recommendation. The Contractor shall capture and remove all roots from the line.

3.05 CHEMICAL ROOT TREATMENT

- A. To aid in the removal of roots, manhole sections that have root intrusion shall be treated with an acceptable herbicide. The application of the herbicide to the roots shall be done in accordance with the manufacturer's recommendations and specifications in such a manner to preclude damage to surrounding vegetation. Any damaged vegetation, so designated by the County, shall be replaced by the Contractor at no additional cost to the County. All safety precautions as recommended by the manufacturer shall be adhered to for handling and application of the herbicide.

3.06 MATERIAL REMOVAL AND DISPOSAL

- A. All sludge, dirt, sand, rocks, grease, roots, and other solid or semisolid material resulting from the cleaning operation shall be removed at the downstream manhole of the section being cleaned. Contractor shall provide appropriate screening to stop passing of materials into downstream sewers. All solid or semisolid materials dislodged during cleaning operations shall be removed from the sewer by Contractor at the downstream manhole of the sewer section being cleaned. The passing of dislodged materials downstream of the sewer segment being cleaned shall not be permitted. In such an event, as observed or detected by the County or any third party, Contractor shall be responsible for cleaning the affected downstream sewers in their entirety, at no additional cost to the County.
- B. These materials shall become the property of the Contractor, shall be removed from the site at the end of each workday, and shall be disposed of by the Contractor. Copies of records of all disposals shall be furnished to the County, indicating disposal site, date, amount, and a brief description of material disposed. Disposal manifests from the licensed disposal facility shall be submitted with invoices.
- C. The Contractor shall keep his haul route and work area(s) neat, clean, and reasonably free of odor, and shall bear all responsibility for the cleanup of any spill.

3.07 ACCEPTANCE OF CLEANING OPERATION

- A. Acceptance of sanitary sewer cleaning shall be made upon the successful completion of the television inspection and shall be to the satisfaction of the County. If television inspection shows the cleaning to be unsatisfactory, the Contractor shall be required to re-clean and re-inspect the sewer line at no additional cost until the cleaning is shown to be satisfactory.
- B. In addition, on all sanitary sewers which have sags or dips, to an extent that the television camera lens becomes submerged during the television inspection, the Contractor shall use a high pressure cleaner to draw the water out of the pipe, or other means, to allow the full circumferential view of the pipe and identification of pipe defects, cracks, holes, and location of service connections.

END OF SECTION

THIS PAGE LEFT BLANK INTENTIONALLY

SECTION 02762
TELEVISIONING SANITARY SEWER SYSTEMS

PART 1 - GENERAL

1.01 SCOPE OF WORK

The Work covered within this Section is for the internal closed circuit television (CCTV) inspection of sanitary sewer pipes. The Contractor shall perform sewer-televising work as necessary to thoroughly document the condition of all sewers, service lateral connections, and manhole corbel, barrel and cone-sections in the study area. The sanitary sewer and service laterals shall be carefully inspected to determine alignment, grade variations, separated joints, location and extent of any deterioration, breaks, obstacles, obstructions, debris, quantities of infiltration/inflow and the locations of service connections.

The quality of all Work specified in this Section shall meet or exceed the requirements of the National Association of Sewer Service Companies (NASSCO) Recommended Specifications for Sewer Collection System Rehabilitation (latest edition), except as described in this Section. Applicable portions of this Section that inadvertently fall below those standards shall be corrected and maintained at the NASSCO standards as a minimum requirement, at no additional cost to the County.

1.02 REQUIREMENTS

- A. The Contractor shall inspect the sewer interior using a color closed circuit television camera (CCTV) and document the inspection on a digital recorder. All inspection video shall be captured in either MPEG or Windows Media Video (.WMV) file format and saved portable hard drives for submittal. Each inspected main line sewer reach, referenced manhole to manhole, and each inspected sewer lateral referenced to the property address and corresponding sewer main should have an associated MPEG or WMV file. Digital photographs (.JPG files), inspection reports (.PDF files) and any handwritten inspection logs or field maps shall accompany the video inspections for each sewer reach (manhole-to-manhole) or lateral inspected.
- B. Contractor shall provide inspection video, data and reports in accordance with the requirements specified herein. Contractor shall provide all video on portable hard drive as specified. All Work will conform to current NASSCO Pipeline Assessment Certification Program (PACP) coding conventions and all software used by the Contractor will be PACP compliant. An electronic database will be provided by the Contractor in a PACP exported format approved by the County.
- C. The Contractor shall provide comments as necessary to fully describe the existing condition of the sewer on the inspection forms.

- D. Contractor shall be responsible for modifications to equipment and/or inspection procedures to achieve report material of acceptable quality.
- E. No Work shall commence prior to approval of the submitted material by the County. Once accepted, the report material shall serve as a standard for the remaining Work.

1.03 QUALITY ASSURANCE

- A. Refer to Section 01101-"Special Requirements (Gravity Inspection Only)" for Contractor's Qualification requirements.
- B. Each CCTV field inspection supervisor shall be NASSCO PACP certified. Use of PACP certified technicians to review/document defects in the office (post process) is not acceptable.
- C. The inspection Contractor must have an internal quality assurance/quality control program in place and all inspection data shall be subjected to the procedures prior to submittal to the County. The County will perform QA/QC audits on submitted data.
- D. QA/QC shall be performed by NASSCO PACP certified personnel.

1.04 SUBMITTALS

- A. Submittals shall be submitted to the County for review and acceptance prior to construction in accordance with the General Conditions and specifications Section 01300 "Submittals."
- B. The following deliverables shall be submitted on a portable hard drive at the completion of inspection:
 - 1. Inspection videos saved in MPEG format or Windows Media video format
 - 2. Electronic version (.pdf) of the pipe inspection reports
 - 3. PACP export pipe inspection database (.mdb)
 - 4. Inspection digital photographs in JPEG format
 - 5. Map of sub area depicting area inspected, inspection status, asset identification numbers and mark ups
 - 6. QA/QC report
- C. The above deliverables shall be submitted monthly to the County for approval. Application for payment shall be made after review and approval by the County.
- D. The sewer inspection video, report documents, and sewer inspection database shall be in accordance with County data standards and NASSCO PACP.

1.05 NOTIFICATION

Contractor shall notify the County a minimum of 48-hours prior to performing any inspection work. No payment will be made for inspections performed without proper notification.

PART 2 - PRODUCTS

2.01 EQUIPMENT

- A. Closed Circuit Television Camera: The television camera used for the inspection shall be one specifically designed and constructed for sanitary sewer inspection. Lighting for the camera shall be suitable to allow a clear picture of the entire periphery of the pipe. The camera shall be operative in 100 % humidity/submerged conditions. The CCTV camera equipment will provide a view of the pipe ahead of the equipment and of features to the side of the equipment through turning and rotation of the lens. The camera shall be capable of tilting at right angles along the axis of the pipe while panning the camera lens through a full circle about the circumference of the pipe. The lights on the camera shall also be capable of panning 90° (degrees) to the axis of the pipe.

The radial view camera must be solid-state color and have remote control of the rotational lens. The camera shall be capable of viewing the complete circumference of the pipe and manhole structure, including the cone-section or corbel. Cameras incorporating mirrors for viewing sides or using exposed rotating heads are not acceptable. The camera lens shall be an auto-iris type with remote controlled manual override.

If the equipment proves to be unsatisfactory, it shall be replaced with adequate equipment. The camera unit shall have sufficient quantities of line and video cable to inspect 2 complete, consecutive sewer reaches with access approximately 750-feet apart.

The camera, television monitor, and other components of the video system shall be capable of producing picture quality to the satisfaction of the County. The television camera, electronic systems and monitor shall provide an image that meets the following specifications, or approved equal:

1. The gray scale shall show equal changes in brightness ranging from black to white with a minimum of five stages.
2. With the monitor control correctly adjusted, the 6-colors; Yellow, Cyan, Green, Magenta, Red, and Blue, plus black and white shall be clearly resolved with the primary colors in order of decreasing luminance. The gray scale shall appear in contrasting shades of gray with no color tint.
3. The picture shall show no convergence or divergence over the whole of the picture. The monitor shall be at least 13-inches diagonally across the picture tube.
4. The live picture on the CCTV monitor shall be capable of registering a minimum of 470 lines horizontal resolution and be a clear, stable image with no interference.
5. Lighting intensity shall be remote controlled and shall be adjusted to minimize reflective glare. Lighting and camera quality shall provide a clear in-focus picture of the entire inside periphery of the sewers and laterals for all conditions except submergence. Under ideal conditions (no fog in the sewer) the camera lighting shall allow a clear picture up to 5 pipe diameter lengths away for the entire periphery of the sewer. The lighting shall provide uniform light free from shadows or hot spots.
6. The camera light head shall include a high-intensity side viewing lighting system to allow illumination of internal sections of lateral sewer connections.

7. Camera focal distance shall be remotely adjustable through a range of 6-inches to infinity.
8. Picture quality and definition shall be to the satisfaction of the County.
9. The monitor and software shall also be able to capture and save screen images of typical sewer details and all defects. Screen images shall be embedded into the pipe inspection report document submitted with the inspection video.
10. The video camera shall be capable of displaying on screen data as specified in paragraph 3.08 herein.
11. Depth gage: The camera shall have a depth gage or approved method to measure deflection in the pipe and joint separation approved by the County.
12. The camera shall have zoom capabilities to be able to view the entire depth of a 20-foot deep manhole from the bottom during inspection.

B. Lateral Video Camera

Lateral cameras may be push type or launched from the sewer main line. Lateral cameras shall be color, shall be self-leveling, and equipped with a footage counter to provide on-screen display of footage measurement. Monitor resolution shall be as specified above in paragraph 2.01 A Close Circuit Television Camera, or approved equal

C. Video Capture System

The video and audio recordings of the sewer inspections shall be made using digital video equipment. A video enhancer may be used in conjunction with, but not in lieu of, the required equipment. The digital recording equipment shall capture sewer inspection on DVD disks or hard drive, with each sewer reach inspection recorded as an individual movie file (.MPEG, .MPG, or .WMV) or approved equal. The video files will be named in accordance with the County file naming convention contained in paragraph 3.11 herein.

1. The video file names will be referenced in the inspection database and in an inspection report generated in PDF format. The pipeline collection and real time video capture and data acquisition systems shall be provided.
2. The system shall use the most current PACP compliant application software and shall be fully object oriented or approved equal. It shall be capable of printing pipeline inspection reports with captured images of defects or other related significant visual information on a standard color printer.
3. The imaging capture system shall store digitized color picture images and be saved in digital format on a DVD, hard drive or approved equal. Also, this system shall have the capability to supply the County with inspection data reports for each line segment.
4. The Contractor shall have the ability to store the compressed video files in industry standard and approved County format and be transferable with the PACP compliant inspection database.
5. The Contractor's equipment shall have the ability to "Link". "Linking" is defined as storing the video time frame code with each observation or defect with the ability to navigate from/to any previously recorded observation or defect instantaneously.
6. The system shall be able to produce data reports to include, at a minimum, all observation points and pertinent data. All data reports shall match the defect severity codes in accordance with PACP naming conventions

7. The data-sorting program shall be capable of sorting all data stored using generic sort key and user defined sort fields.
8. Camera footage, date & manhole numbers shall be maintained in real time and shall be displayed on the video monitor as well as the video character generators illuminated footage display at the control console.
9. Digital video shall be defined as ISO-MPEG Level 1 (MPEG-1) coding having a resolution of 352 pixels (x) by 240 pixels (y) (minimum) and an encoded frame rate of 29.97 frames per second. The digital recording shall include both audio and video information that accurately reproduces the original picture and sound of the video inspection. The video portion of the digital recording shall be free of electrical interference and shall produce a clear and stable image. The audio portion shall be sufficiently free of background and electrical noise so as to produce an oral report that is clear and discernible.
10. Inspection software shall be PACP compliant versions of CUES Granite XP, WinCan, Flexidata, or approved equal.
11. The CCTV equipment/software shall be capable of producing digitized images of all sewer line defects, manhole defects, and sewer line service connections in .jpeg format. Contractor shall plan to take digital still images of each defect, construction features and service connection to clearly depict it. More images may be necessary depending upon the condition of the pipe.

2.02 REPORTING CAPABILITIES

- A. The CCTV system shall be capable of printing pipeline inspection reports with pipeline schematics and captured images of defects and other related significant visual information. The system shall have the ability to display any combination of the following formats and features simultaneously.

The following information is mandatory for all inspections:

1. Inspection Information: Refers to the area of pipe to be inspected between 2 manholes or the address of the lateral to be inspected.
 - a. Project Name
 - b. Surveyed by (Operator/Surveyor's name)
 - c. Operator/Surveyor Certificate number
 - d. System Owner
 - e. Date
 - f. Drainage Area (tributary pump station number)
 - g. Time
 - h. Sheet number (report sheet number)
 - i. Street Name and Number
 - j. Locality (Orange County)
 - k. Additional Location Information (e.g. backyard, parking lot, etc)
 - l. Upstream Manhole Number (County standard Asset Number)
 - m. Upstream MH rim to invert (depth)
 - n. Downstream Manhole Number (County standard Asset Number)
 - o. Downstream MH rim to invert (depth)
 - p. Direction of inspection (Upstream or Downstream)

- q. DVD Identification Number
 - r. Flow control (e.g. plugged, lift station, bypassed, not controlled)
 - s. Type of Pipe
 - t. Pipe Height
 - u. Pipe Width
 - v. Pipe Shape
 - w. Pipe Material
 - x. Lining Material (for lined sewers)
 - y. Pipe Joint Length
 - z. Purpose of Inspection (new line, year-end warranty, CIP R/R project, etc.)
 - aa. Pre Cleaning (jetter, heavy cleaning, no pre-cleaning)
 - bb. Media Number (Video file name)
 - cc. Weather
 - dd. Additional information/Comments
2. Observation Data: Refers to the portion of pipe where an observation is discovered. Observations shall be noted by text descriptions and defect code number using PACP defects codes, still frame pictures and video clips captured and recorded. Each observation shall include the following:
 - a. Actual observation footage
 - b. Video reference
 - c. Location of defect; clock position
 - d. Code (Group/Descriptor/Modifier/Severity)
 - e. Whether it is a continuous defect
 - f. Whether the defect occurs at a joint
 - g. Severity level
 - h. DVD Identification number
 - i. DVD counter
 - j. Final footage
 - k. Video clip ID for each observation
 - l. Image reference (file name of photos)
 - m. Remarks (as appropriate or needed)
 3. Formats: Standard and/or custom designed reports shall have the following formats available and shall be able to be produced in hard copy or viewed on the monitor.
 - a. Site Observation: Displays detailed site observation reports in landscape or portrait views.
 - b. Directory Report: Displays a list of all the projects sorted by pump station number and manhole number.
 - c. Picture Reports: Displays site data and include full size single photos or half size double photos of discrepancies.
 - d. Pipe Run: Displays a graphical display of the site indicating footage, observations, and comments.
 - e. Project Data: Displays the project, client, and Contractor information.
 - f. Custom Sort: Creates user-defined reports of selected site, project, and observation data.

PART 3 - EXECUTION

3.01 GENERAL

- A. Prior to inspection the Contractor shall obtain pipe and manhole asset identification numbers from the County to be used during inspections. Inspections performed using identification numbers other than the County assigned numbers will be rejected.
- B. Inspection shall not commence until the sewer section to be televised has been completely cleaned in conformance with Specification Section 02761 "Cleaning Sanitary Sewer Systems."
- C. Inspection of newly installed sewers (not yet in service) shall not begin prior to completion of the following:
 - 1. Pipe air testing
 - 2. All manhole work, including installation of inverts
 - 3. Installation of all lateral services
 - 4. Vacuum tests of all manholes
- D. After the sewer main and/or lateral cleaning operation is completed, the line sections shall be visually inspected internally by means of color closed-circuit television. The television inspection shall be performed one line section at time.
- E. CCTV inspection shall require a minimum of 2 certified personnel with PACP certifications.
 - 1. One (1) person shall have PACP certification that will lead or supervise each field CCTV crew for inspection and a minimum of 2-years in the role of a lead person.
 - 2. One (1) person shall have PACP certification serving in the role as a QA/QC management supervisor
- F. Contractor shall perform sewer-televising work within 24-hours of said sewer being cleaned. If said sewer is not televised within the required 24-hour time limit, the sewer shall be re-cleaned prior to televising at no additional expense to the County.
- G. The Contractor shall also inspect and document all manholes included in this Work. The video recording shall begin as the camera is lowered down the manhole all the way to the preset footage and continuously throughout the pipe reach until the down stream manhole is reached.
- H. The Contractor shall lower the camera into the start manhole and record the camera entry into the sewer, observing the manhole as the camera enters.
- I. The camera shall pan the periphery of the start and finish manhole from casting to invert. To achieve this, the CCTV camera operator shall pan and zoom the manhole to obtain the best possible image of the manhole, including the wall, cone and chimney section(s).
- J. The depth of each manhole shall be measured to the nearest 1/10th of a foot and documented on the inspection forms. Estimates of manhole depths will not be accepted.

- K. The CCTV camera shall be positioned as close to the spring line as possible while maintaining the required equipment stability.
- L. Wherever possible the inspections shall be performed in the upstream to downstream direction. All sewer segments shall be recorded in a logical order in the same direction they are cleaned and televised.
- M. In the event that access to some manholes is restricted, permission may be granted by the County to direct the camera through the sewer in an upstream direction, against the flow.
- N. When sewer conditions prevent forward movement of the camera, the camera shall be withdrawn, and Contractor shall televise the line from the opposite direction.
- O. The camera shall be directed through the sewer in a downstream direction, with the flow, at a uniform, slow rate. In no case will the video camera record while moving at a speed greater than 30-feet per minute. If, during the course of the Project, the inspection is rejected due to camera speeds exceeding 30-feet per minute, the inspection recordings shall be redone, at no additional cost to the County.
- P. If a new manhole is discovered in the field that was not on current maps, a new manhole identification number will be assigned by County. The County shall assign the manhole the next number above the highest manhole number within the sub area. The data / video files shall then be re-named to include the new MH ID, and a new CCTV inspection shall be started from the new MH ID. Contractor shall consult with the County for assignment of new manhole identification numbers. Contractor shall note in the inspection form comments that a new manhole ID has been assigned as well as provide a marked up map indicating the newly found manhole and assigned manhole ID.
- Q. Flow levels within existing sewers to be inspected shall not exceed 5% of the pipe diameter. If water levels prevent adequate televising of the sewer, then conducting the Work during low flow periods or other methods like plugging and bypass pumping shall be implemented.
- R. For inspection of new sewers (not yet in service), the Contractor shall introduce clean water into the upstream manhole and keep water flowing until flow is observed at the downstream manhole location.
- S. The survey unit shall be slowed, stopped, or backed up to perform detailed inspections of significant features. The camera shall be stopped at all defects, changes in material, water level, size, side connections, manholes, junctions, or other unusual areas. When stopped at the defect or feature, the operator shall pan the camera to the area and along the circumference of the pipe.
- T. The camera unit shall be paused long enough at areas suspected of leaking to determine if a leak exists currently or if deposits have occurred.
- U. The operator shall also record audio of the type of defect or feature, clock position, footage, extent or other pertinent data.

- V. Digital photographs or screen captures shall be taken at all laterals; defects and general condition photographs shall be taken at least every 200-feet.
 - W. At the Contractor's discretion or direction of the County, the camera shall be stopped or backed up (when conditions allow) to view and analyze conditions that appear to be unusual or uncommon for a sound sewer. The lens and lighting shall be readjusted, if need be, in order to ensure a clear, distinct, and properly lighted feature.
 - X. Audio shall be recorded during each inspection by the operating technician, electronic voice text recognition or approved equal on the inspection video as the sewer is inspected and shall include the sewer location, identification of beginning and terminating manholes including location (address or cross streets), inspection direction, length of inspection, side sewer identification, flow information, complete descriptions of the sewer line conditions as they are encountered, description of the rehabilitation work, reason for termination, and other relevant commentary to the inspections. Voice descriptions should be made:
 - 1. At points of pipe failure or weakness
 - 2. At points of infiltration
 - 3. At the location of service connections
 - 4. At points where unusual conditions are noted, and
 - 5. At points where digital still photos are taken.
- In addition, the audio reports shall include the distance traveled on the specific run, a description of abnormal conditions in the sewer and side sewer connections as they are encountered, explanations for pausing, backing up, or stopping the survey, and the final measured center to center distances between consecutive manholes. The audio portion of the composite video shall be sufficiently free from electrical interference and background noise to provide complete intelligibility of the oral report. Audio dubbing after the inspection is prohibited.
- Y. Video recordings shall include a continuous video display/readout of similar information, as described in paragraph 3.08 herein. A separate digital video file shall be made for each pipe reach inspected.
 - Z. Contractor shall coordinate with the County prior to commencement of Work to ensure inspection is accomplished in a manner acceptable to the County.
 - AA. If the video and/or audio recording is of poor quality, the County has the right to require a re-submittal of the affected sewer sections and no payment will be made until an acceptable video and audio recording is made, submitted to, and accepted by the County.
 - BB. Measurement for location of defects and actual length of pipe shall be by means of a calibrated meter on the camera with a digital readout on the video monitor. This readout shall be included in the video recording. Marking on cable, or the like, which would require interpolation for depth of manhole, will not be allowed. Measurement will be accurate to 1-foot per 100-feet of inspected pipe.

- CC. The Contractor inspection units shall be equipped with adequate back up equipment and spare parts so field repairs to equipment can be made and down time is minimized.
- DD. The Contractor shall be responsible for all traffic control measures required to perform the Work.
- EE. Lateral inspections shall be performed from the main line using a lateral launch camera or shall be pushed from cleanouts to the sewer main using sewer rods. Lateral camera travel measurements shall be displayed on screen and on the captured video.
- FF. If lateral inspections are performed from the sewer main as part of the main line inspection, the lateral shall be logged in the main line inspection report per PACP requirements and the "comment" field of the main line inspection report shall be used to document the lateral identification number, defects observed, footage of all lateral defects, connecting pipes and clean outs. If lateral inspections are not performed as part of the main sewer inspection, a separate PACP pipe inspection record shall be created for each lateral. Refer to paragraph 3.10 for numbering requirements.

3.02 PRE-CONSTRUCTION INSPECTION

A. Procedure

1. Prior to any repair work, the entire sewer line (from manhole to manhole) shall be televised. The pre-construction inspection shall be used to determine whether the line has been cleaned sufficiently; to confirm the location and nature of defects; and to confirm that the proposed method of repair is proper method for the defects observed.
2. The camera shall be moved through the line in either direction at a moderate rate, stopping when necessary to permit documentation of the sewer's condition. In no case will the television camera be pulled at a speed greater than 30-feet per minute. Manual winches, power winches, TV cable, and power rewinds or other devices that do not obstruct the camera view or interfere with proper documentation of the sewer conditions shall be used to move the camera through the sewer line. If, during the inspection operation, the television camera will not pass through the entire manhole section, the Contractor shall set up his equipment so that the inspection can be performed from the opposite manhole (reverse set-up).
3. When manually operated winches are used to pull the television camera through the line, telephones, radios or other suitable means of communication shall be set up between the 2 manholes of the section being inspected to insure good communication between members of the crew.
4. The importance of accurate distance measurements is emphasized. The location of defects shall be within ± 2 feet.
5. During the internal inspection the television camera shall be temporarily stopped at each defect along the line. The Contractor shall record the nature and location of the defect. Where defects are also active infiltration sources, the rate of infiltration in gallons per minute shall be estimated by the Contractor and recorded. The camera shall also be stopped at active service connections where flow is discharging. Flows from service connections that are determined to be infiltration/inflow shall also be recorded.

B. Documentation of Television Inspection

1. Television Inspection Logs: Printed location records shall be kept by the Contractor and will clearly show the location in relation to an adjacent manhole of each infiltration point observed during inspection. In addition, other points of significance such as locations of building sewers, unusual conditions, roots, storm sewer connections, broken pipe, presence of scale and corrosion, and other discernible features will be recorded and a copy of such records will be supplied to the County. The Contractor shall record all visual observations on a "Television Inspection Report" form.
2. Once recorded, the digital data shall be labeled and become the property of the County. The Contractor shall have all readings and necessary playback equipment readily accessible for review by the County during the Project.

3.03 POST CONSTRUCTION INSPECTION

A. Procedure

1. After the sewer line rehabilitation has been completed, the entire sewer line from manhole to manhole shall be televised. The post construction inspection shall be used to determine whether or not all of the approved sewer line defects and infiltration sources previously located have been fully repaired to the satisfaction of the County.
2. The camera shall be moved through the line in either direction at a moderate rate, stopping when necessary to permit documentation of the sewer's condition. In no case will the television camera be pulled at a speed greater than 30-feet per minute. Manual winches, power winches, TV cable, power rewinds or other devices that do not obstruct the camera view or interfere with proper documentation of the sewer conditions shall be used to move the camera through the sewer line. If, during the inspection operation, the television camera will not pass through the entire manhole section, the Contractor shall set up his equipment so that the inspection can be performed from the opposite manhole or direction.(reverse-setup)
3. When manually operated winches are used to pull the television camera through the line, telephones, radios or other suitable means of communication shall be set up between the 2 manholes of the section being inspected to insure good communication between members of the crew.
4. The importance of accurate distance measurements is emphasized. The location of defects shall be within 1-foot.
5. During the internal inspection the television camera shall be temporarily stopped at each repair. The camera shall also be stopped at any unnoticed or non-repaired point source of infiltration.

3.04 SEWER BYPASSING AND DEWATERING

Contractor shall be responsible for bypassing sewer flow around his work and dewatering of sewer lines in accordance with the requirements of Section 01516 "Collection System Bypass". Where sags or submerged sections of the sewer are encountered during TV inspection, the Contractor shall first complete inspection of the entire reach to determine the extent of such areas prior to dewatering the sewer. Dewatered sections of the sewer shall then be TV inspected.

On all sewer mains which have sags or dips, to an extent that the television camera lens becomes submerged during the television inspection, the Contractor shall use a high pressure cleaner to draw the water out of the pipe, or other means, to allow inspection of the pipe and identification of pipe defects, cracks, holes and location of service connections.

3.05 LINEAR MEASUREMENT

The CCTV camera location footage counter shall be zeroed at the beginning of each inspection. The survey unit location entered on the footage counter at the start of the inspection shall allow for the distance from the accepted start of the length of the sewer to the initial point of observation of the camera (pre-set footage). In the case of resuming an inspection at an intermediate point within a sewer reach, the footage counter shall be set to start at the distance from the upstream maintenance hole to that point, as previously recorded by the counter. The Contractor shall ensure that the footage counter starts to register immediately when the survey unit starts to move.

The lateral camera shall be pushed from cleanouts to the sewer main and be equipped with a footage counter to display and record inspection footage. Maximum rate of travel shall be 30-feet per minute when recording.

Prior to commencing inspections, the Contractor shall demonstrate compliance with the linear measurement tolerance specified below:

- A. The equipment shall measure the location of the camera unit in 1-foot increments from the beginning (upstream end) of each continuous section. This footage location must be displayed on the CCTV monitor and recorded on the videotapes.
- B. The accuracy of the measured location shall be within + 0.5% of the actual length of the sewer-reach being surveyed, or 1-foot, whichever is greater.

3.06 MEASUREMENT OF SAGS

The CCTV camera shall be equipped with a measuring device capable of accurately measuring the depth of standing water up to 3-inches. The measuring device shall be mounted to the front of the unit and be capable of being read as the unit advances through the pipe.

3.07 CCTV MONITOR DISPLAY

The images displayed on the CCTV monitors will be a view of the pipe above the water surface as seen by the CCTV camera as the unit is conveyed through the sewer.

The camera lighting shall be fixed in intensity prior to commencing the survey and the white balance set to the color temperature emitted. In order to ensure color constancy, no variation in illumination shall take place during the survey.

The video equipment shall be checked using an approved test card with a color bar prior to commencing each day's survey. The camera shall be positioned centrally and parallel to the test card at a distance where the full test card just fills the monitor screen. The card shall be illuminated evenly and uniformly without any reflection.

3.08 DATA DISPLAYS

- A. The CCTV images shall include an initial data display that identifies the sewer reach being surveyed and a survey status display that provides continuously updated information on the location of the survey unit as the survey is being performed. These data displays shall be in alphanumeric form. The size and position of the data shall not interfere with the main subject of the monitor picture.
- B. The on-screen display should be white during inspections where the background behind the display is dark and, conversely, black where the background is light.
- C. At the beginning of each reach of sewer being inspected, the following information shall be electronically generated and displayed on the CCTV monitors as well as included in the audio track:
 - 1. Date of survey
 - 2. Inspection company name and inspector
 - 3. Street name or location
 - 4. Manhole number to manhole number (in order of inspection)
 - 5. Direction of survey (upstream or downstream)
 - 6. Time of start of survey
- D. During inspections, the following information shall be electronically generated, automatically updated, and displayed on the CCTV monitors:
 - 1. Survey unit location in the sewer line in feet and tenths of feet from adjusted zero
 - 2. Sewer diameter
 - 3. Upstream and downstream manholes reference numbers as per approved Drawings or County GIS.
 - 4. During Lateral inspections the video display shall contain the lateral location and the footage of the camera within the lateral.

3.09 PHOTOGRAPHS

During CCTV inspections, screen captures will be taken from the monitor images and saved electronically by the in-sewer inspection crew of typical conditions every 200-feet and at all defects, construction features, manholes and laterals. The screen capture shall have the pipe reach (identified by the upstream and downstream manholes), survey direction, footage, and date when photograph was taken. The annotation shall be clearly visible and in contrast to its background, shall have a figure size no greater than 1/4-inch, and shall be type-printed. The annotation shall be positioned on the front of the photograph so as to not interfere with the subject of the photograph. Photograph files shall be named by the video capture system and automatically referenced to the logged defect.

The image of the sewer shall fill the photographic image. Photographs must clearly and accurately show what is displayed on the monitor, which shall be in proper adjustment. Where significant features exist within 6-feet of each other, 1 photograph shall be made to record these features. Where there is a continuous feature, photographs shall not be taken at intervals of less than 6-feet unless absolutely necessary to show a change in the feature.

The images shall be kept electronically, copied to a hard drive, and submitted with the inspection videos, database and reports.

3.10 MANHOLE NUMBERING, INSPECTION FORMS AND DEFECT CODES

- A. The Contractor will be required to use the manhole numbering as shown on sewer maps provided by the County when performing the inspections for this project.
- B. The County inspection forms and standard defect codes shall be used. The defect codes, inspection forms, inspection database and inspection protocols shall be in accordance with the National Association of Sewer Service Companies (NASSCO) Pipeline Assessment and Certification Program (PACP).
- C. When lateral inspections are performed as part of the main sewer inspection, lateral numbers shall be referenced in the "comment" field of the main sewer PACP report. The lateral number shall be as follows:

<Upstream Manhole ID>_<footage>_<clock position>_<L>

Example: 39550020_212_02_L

- D. When lateral inspections are not performed as part of the main sewer inspection, the main sewer inspection shall be performed first to obtain the footage and clock positions needed to identify the lateral.

3.11 DELIVERABLES

The Contractor will be required to submit the following deliverables at the completion of the post construction video inspection. The pre-construction video inspection deliverables shall be as defined in 3.02 of this specification.

- A. Inspection Reports to include:
 - 1. Inspection session header information (see required fields above)
 - 2. Defect log report including photo captures from CCTV video
 - 3. Schematic drawing of pipe showing defects
 - 4. Format:
 - a. Adobe Acrobat PDF files: 1 report PDF per pipe
 - b. Main sewer inspection report file name:

<upstream MH ID>_<downstream MH ID>_<Date (year_mo_day format)>.PDF

Example: 30060002_30060001_2010_02_16.pdf

c. Lateral inspection report file name:

<upstream MH ID>_<footage>_<clock position>_<L>_<Date (year_mo_day format)>.PDF_

Example: 30060002_210_02_L_2010_02_16.pdf

B. Inspection video files on portable hard drive, typed labels shall be attached to the face of each hard drive. The typed index labels shall include the following information:

1. Content (CCTV)
2. Contractor name
3. Purpose of Survey
4. Tributary Pump station number
5. Reaches included (from Manhole Number ## to Manhole Number ##)
6. Date of survey
7. Contract Number / Delivery Order Number (if applicable)

C. Main sewer video files shall be MPEG or Windows Media File named according to the following standard:

<Upstream MH ID>_<Downstream MH ID>-<Inspection>_<Date (year month day)>.wmv

Example: 39540008-39540007_20090805.wmv

In instances where a reverse set up is necessary to perform or complete the inspection the file name shall incorporate a "R" at the end of the file name to indicate "reverse" direction. Using the file example above, if the inspection from the upstream end was halted due to an obstruction and the pipe was televised from the opposite end, the video file from the downstream to upstream direction would be assigned the following file name:

Example:39540008-39540007_20090805_R.wmv

D. Lateral connection inspection video files shall be MPEG or Windows Media File named according to the following standard:

<Upstream MH ID>_<footage>_<clock position>_<L>_<date (year_mo_day format)>.wmv

Example: 39540008_145_10_L_2009_08_05.wmv

E. Electronic Inspection Data stored and exported in a NASSCO Pipeline Assessment and Certification Program (PACP) compliant Microsoft Access database (.MDB) version 4.4 or newer delivered on DVD or portable hard drive.

F. Inspection photograph digital files (jpeg) indexed to NASSCO PACP compliant database.

G. Map of sub area depicting area inspected, inspection status, asset identification numbers and mark ups,

H. Acceptable media for the video recordings portable hard drive.

- I. Inspection data noted above shall be provided to the County weekly throughout the inspection work.
- J. Contractor Quality Control report detailing data validation performed, pipe inspection records reviewed and results.
- K. All inspection data shall be submitted on a portable hard drive. Each hard drive shall be filled with as much data as practical to minimize the number of hard drives submitted. Sections of a single segment of sewer main shall not be recorded to more than 1 hard drive. Video footage of recorded segments shall be grouped by area and shall be submitted in sequential order relating to the area mapping designation.
- L. Upon approval by the County of all, or portions of, the data delivered via the portable hard drives, the approved CCTV data shall be delivered to the County on a portable hard drive labeled with project information. The hard drive shall clearly indicate the date of the inspection, the designated segment(s) of sewer mains(s) contained on the disk, the name of the project, the project CIP number, the pump station number, and Contractor name. The hard drive shall contain separate digital files for each manhole-to-manhole section.
- M. The database shall be comprehensive for the entire project, and additional data shall be added to the database each week.

3.12 ACCEPTANCE

- A. Inspection deliverables will be validated to check conformance with the specified requirements for file names, formats, quantity, resolution, data table references, in addition to checks for null fields, asset numbers, duplicate records, connectivity, material, size, and depth. Any data not passing the data validation checks will be returned to the Contractor for resubmittal.
- B. Inspection submittals will be reviewed for quality control. A minimum of 5% of the submitted inspections will be randomly reviewed. A quality control check will be performed for each CCTV operator and each operator must exceed 90% accuracy. Reference Section 01101 "Special Requirements (Gravity Inspection Only)."
- C. Throughout the duration of the project, should the County discover inaccuracies in data or quality issues with any of the videos, Contractor shall re-inspect those segments at no additional cost to the County. The County will provide comments regarding acceptance of the data within 21-days of receiving the data from the Contractor. Neither the CCTV inspections nor the WORK inspected is accepted by the County until such time that an acceptance letter is issued by the County.

END OF SECTION

SECTION 02771
CURE-IN-PLACE PIPE FOR SANITARY SEWER RENEWAL

PART 1 - GENERAL

1.01 REQUIREMENTS

- A. The Work within this Section consists of the installation and testing cured-in-place pipe (CIPP) lining by installation of a resin impregnated flexible felt tube into the existing sanitary sewer pipe utilizing a vertical inversion standpipe and hydrostatic head, pulled in place, or other approved method and curing by circulating hot water or other approved means to produce a hard, impermeable pipe.
- B. The finished liner shall extend over the installation length in a continuous, tight fitting, watertight pipe-within-a-pipe and shall be fabricated from materials which, when installed, will be chemically resistant to withstand internal exposure to domestic sewage. The Contractor shall confirm through field measurements the actual length, diameter and depth of the sewer pipe to be rehabilitated prior to fabricating the liner.

1.02 INSTALLER EXPERIENCE AND QUALIFICATIONS

- A. The installer must have sufficient experience in the commercial installation of the liner and must have installed a minimum of 50,000 lineal feet. The inability to document such experience may be grounds for rejecting the proposed installer.
 - 1. Superintendent's resume of projects. Each reference project shall include the pipe dimensions, length of installation, size/type of flow control required to perform the Work, description of the actual work performed including installation method, owner's name, telephone number and contact person, date of installation. The Contractor shall submit the name(s) and qualifications for each scheduled superintendent for this project. It is required that the Superintendent(s) named are the Superintendent(s) assigned to this project and on site during construction. The Contractor is required to have at least 1 qualified Superintendent on site at all times during the construction activities. All referenced experience shall be for projects completed within the United States or Canada and shall have used the same installation method, CIPP liner and resin combination proposed for this project. References will be checked.
 - 2. The proposed Superintendent must have a minimum of 3-years of CIPP lining supervisory field experience on projects totaling a minimum of 50,000 LF of 8-inch or greater CIPP liner installation using the methods and materials proposed for this Work, as documented by verifiable references.

3. Installation Crew: At least 1 person other than the Superintendent from the CIPP installation crew shall have a minimum of 1-year of CIPP experience totaling at least 20,000 lineal feet of 8-inch or greater installed liner. The crewmember with listed qualifications must be on the project site during all installation activities.
4. Boiler Technician: Contractor shall provide the name and information for the boiler technician who will perform the actual Work. The boiler technician must have a minimum of 2 projects totaling at least 10,000 lineal feet of CIPP lining in which a similar position was held.
5. Lateral Cutter Technician: Contractor shall provide the name and information for the technician who will perform the actual Work. The lateral cutter technician must have a minimum of 2 projects totaling at least 10,000 lineal feet of CIPP lining in which a similar position was held.
6. The final decision to accept or reject the product, manufacturer, and/or installer lies solely with the County. The named Manufacturer, Field Superintendent, CIPP Installer, Lateral Cutter, and Boiler Technician must be employed to perform the Work, unless changes are specifically authorized by the County.

1.03 REFERENCES

A. Codes, Specifications, and Standards

1. Codes, specifications, and standards referred to by number or title shall form a part of this specification to the extent required by the references thereto. Latest revisions shall apply, unless otherwise shown or specified.
2. All pipe materials incorporated in the project shall be approved by the Florida Environmental Protection Division for the application to be used, prior to receipt of bids.
3. American Society for Testing and Materials (ASTM) Standards
 - a. D 638 - Test Method for Tensile Properties of Plastics
 - b. D 790 - Test Methods for Flexural Properties of Un-reinforced and Reinforced Plastics and Electrical Insulating Materials
 - c. D 1222 - Determining Dimensions of Thermoplastic Pipe and Fittings
 - d. D 2837 - Obtaining Hydrostatic Design Basis for Thermoplastic Pipe Materials
 - e. F 1216-98 - Rehabilitation of Existing Pipelines and Conduits by Inversion and Curing of a Resin-impregnated Tube
 - f. F 1743-96 - Rehabilitation of existing pipelines and conduits by pulled-in-place installation of cured-in-place thermo setting resin pipe

1.04 RESPONSIBILITY FOR OVERFLOWS AND SPILLS

- A. It shall be the responsibility of the Contractor to schedule and perform his work so as to result in no overflows or spills of sewage or combined sewage from the system. If sewage flows are such that they interfere with the Contractor's ability to perform work, the Contractor shall be responsible for scheduling his work during low flow periods or provide bypass pumping. Bypass pumping shall be provided only with the specific written approval of the County.

- B. In the event of overflows caused by the Contractor's work activities, the Contractor shall immediately take appropriate action to contain and stop the overflow, clean up the spillage, disinfect the area affected by the spill, and notify the County in a timely manner.
- C. Contractor will indemnify and hold harmless the County for any fines or third-party claims for personal or property damage arising out of a spill or overflow that is fully or partially the responsibility of the Contractor. Should fines subsequently be imposed as a result of any overflow for which the Contractor is fully or partially responsible, the Contractor shall pay all such fines and all of the County's legal, engineering, and administrative costs in defending such fines and claims associated with the overflow.

1.05 SHOP DRAWINGS AND SUBMITTALS

- A. Submittals shall be submitted to the County for review and acceptance prior to construction in accordance with the General Conditions and specifications Section 01300 "Submittals."
- B. Submit the following:
 - 1. The Qualifications of the installer shall be submitted 1-week prior to Pre-Construction conference.
 - a. Name: business address and telephone number of the Contractor
 - b. Name(s) of personnel and experience for Field Superintendent, CIPP Installer, Lateral Cutter, and Boiler Technician to be directly involved with this project
 - c. The Contractor shall sign and date the information provided and certify that to the extent of his knowledge, the information is true and accurate, and that the supervisory personnel will be directly involved with and used on this project. Substitutions of personnel and/or methods will not be allowed without written authorization of the County.
 - d. Specialty technicians shall be certified by the equipment manufacturer and/or its authorized representative. Certifications shall be submitted to the County/Professional.
 - e. The Contractor shall provide his references of previous project lists going back 3-years including his customer's names, owner's contact name, phone number, owner's project number, owner's project name and the list must include the linear feet of liner installed.
 - 2. Manufacturer's Certificate of Compliance certifying compliance with the applicable specifications and standards, a minimum of 500,000 linear feet of liner installed in U.S.
 - 3. The Manufacturer shall warrant the liner to be free from defects in materials and installation for an extended 5-years from the date of Final Acceptance.
 - 4. Certified copies of test reports of factory tests required by the applicable standards and this Section.
 - 5. Manufacturer's installation instructions and procedures.
 - 6. Contractor's procedures and materials for service renewal including time and duration of sewer service unavailability.

7. Data, measurements, assumptions and calculations for sizing liners, signed and sealed by a Professional Engineer registered in the state of Florida and certified by the manufacturer as to the compliance of his materials to the values used in the calculations.
 8. Sampling procedures and locations for obtaining representative samples of the finished liner.
 9. List of primary and backup equipment to be utilized on the job.
 10. Contractor shall submit manufacturer's detailed procedures for repairing liners that have been installed incorrectly or that have failed during installation.
 11. The Contractor shall submit a wastewater pre-treatment plan including data, measurements, assumptions, calculations and procedures for the pre-treatment of CIPP process wastewater containing regulated chemicals.
- C. A final certificate of compliance with this specification shall be provided by the manufacturer for all lining material furnished. Tests for compliance by an independent laboratory shall be made according to the applicable ASTM specification and the manufacturer's quality control program.
- D. As part of the design calculation submittal, the liner manufacturer shall submit a tabulation of time versus temperature. This tabulation shall show the lengths of time that exposed portions of the liner will endure without self-initiated cure or other deterioration beginning. This tabulation shall be at 5°F (degrees Fahrenheit) increments ranging from 70°F to 100°F. The manufacturer shall also submit his analysis of the progressive effects of such "pre-cure" on the insertion and cured properties of the liner. This information shall be submitted in a timely fashion prior to construction. The minimum liner thickness is for materials with characteristics as shown. Bidders with materials with other characteristics must supply complete information in their bids of the values as listed for ascertaining minimum thickness.
- E. Approval of Products
1. A product will be considered for approval if a minimum of 500,000 lineal feet of the proposed pipe liner has been installed in sewer collection pipes in the United States. An acceptable third party testing facility shall perform all tests. These tests shall be based on the following standards:
 - a. Materials tested shall be identical to those proposed for installation from samples of materials in final resting place after the trauma of installation and/or reforming of the product. Testing shall be in accordance with applicable ASTM standards. Laboratory samples will not be acceptable.
 - b. Short-term tests can be extrapolated using actual short-term test data and applicable ASTM standards for plastic pipe.
 - c. An independent third party qualified in these testing procedures shall validate all test data (whether theoretically extrapolated or actual).
 - d. The manufacturer shall submit all ASTM standards for installation and/or materials on their product. Foreign standards will not be accepted.

- e. Manufacturer shall submit an engineering design guide and quality control procedures for product manufacturer and for product installation, including detailed inspection, testing of physical properties, retention of product samples, taking of and testing of field samples.
- f. Manufacturer shall submit statements as to country of manufacturer of all major components used to produce the final installed product.
- g. Manufacturer and installer shall submit evidence of installer training, testing and/or certification of being trained to install the product by the manufacturer.
- h. Manufacturer shall provide detailed installation procedures, detailed procedures for reconstruction of existing laterals and for new service connections. This shall include an itemized list of the tasks to be performed and the estimated times for each task. Manufacturer shall include the estimated number of excavations, if any, required for each line segment to be installed.
- i. Manufacturer shall submit detailed procedures of repairing its own product in the event of failure.
- j. In the event change in the product (material) occurred within the past 3-years, the manufacturer shall disclose in writing, the date each change occurred, what change occurred, the reason for the change, the number of lineal feet installed within each change period, the last date since a change occurred, and the number of lineal feet installed since the last change. The County reserves the right to require additional detailed information on the product (material) in the event changes have occurred.

1.06 DELIVERY, STORAGE, AND HANDLING

- A. The Contractor shall be responsible for the delivery, storage, and handling of products. No products shall be shipped to the job site without the approval of the County.
- B. Keep products safe from damage. Promptly remove damaged products from the job site. Replace damaged products with undamaged products.

1.07 LINE OBSTRUCTIONS

- A. It shall be the responsibility of the Contractor to clear the line of obstructions such as solids and roots that will prevent the insertion of CIPP. If pre-installation inspection reveals an obstruction such as protruding service connection, dropped joint, or a collapse that will prevent the inversion process, that was not evident on the video and it cannot be removed by conventional sewer cleaning equipment, the County will be notified immediately.

PART 2 - PRODUCTS

2.01 GENERAL

- A. All material supplied shall be one of the products specified in Appendix D "List of Approved Products" appended to these technical specifications.

- B. Pipe lining products pre-approved by the County include: Insituform (CIPP Liner), National Liner (CIPP Liner), LMK Enterprises (Performance Liner), Steven's Technologies (CIPP Liner 2 part 100% epoxy), Inner Cure Technologies (Reichold/Dion CIPP Liner), Lanzo Lining (Lanzo CIPP Lining System), and Premier Pipe (Premier Pipe CIPP Lining System). All other products must meet the specification herein and will require approval, as specified prior to installation.
- C. The materials used shall be designed, manufactured, and intended for sanitary sewer pipe relining and the specific application in which they are used. The materials shall have a proven history of performance in sewer relining and rehabilitation. All materials shall be stored and handled in accordance with recommendations of the manufacturer. All materials shall be installed in accordance with the manufacturer's written instructions.
- D. The finished pipe liner in place shall be fabricated from materials which when complete are chemically resistant to and will withstand internal exposure to domestic sewage having a pH range of 5 to 11 and temperatures up to 150°F.
- E. Take all necessary field measurements of the existing pipe (including diameter, ovality and length) prior to manufacturing liners.
- F. The minimum length shall be that deemed necessary by the Contractor to effectively span the distance from the inlet to the outlet of the respective manholes unless otherwise specified. The Contractor shall verify the lengths in the field before manufacturing.

2.02 STRUCTURAL REQUIREMENTS

- A. The liner shall be fabricated to a size that when installed will neatly fit the internal circumference of the conduit to be repaired as specified by the County.
- B. The minimum required structural CIPP wall thickness shall be based on the physical properties described above and in accordance with the design equations in the appendix of ASTM F 1216, and the following design parameters:

Design Considerations	Criteria
Tube Design	ASTM F 1216 Appendix X1
Hydrostatic Buckling	ASTM F 2561 Section 6.1 and 6.1.1
Design Safety Factor	2.0
Retention Factor for Long Term Flexural Modulus to be used in Design	50 %
Ovality	2 %
Groundwater Depth = Pipe Depth (above invert)*	100% depth from pipe to surface
Lining enhancement factor	7 maximum
Soil Modulus	1,000 psi
Soil Density	120 pcf
Live Load	One (1) H20 passing truck
Design Condition	Fully deteriorated

- C. The Contractor shall submit the structural design of the liner for sewers and laterals, signed and sealed by a Professional Engineer in the state of Florida, subject to review by the County.
 - 1. Design may be based on material properties of the liner that exceed the minimum values specified in ASTM F1216. However, the initial flexural modulus used in structural design calculations shall not exceed 400,000-psi.
- D. Each CIPP shall be designed to withstand internal and/or external loads as dictated by the site and pipe conditions. When not specified by the County in the contract documents, the design thickness of the CIPP shall be arrived at using standard engineering methodology as found in ASTM F1216. In no case shall the finished thickness of the cured liner be less than six millimeters. The long-term modulus shall not exceed 50 percent of the short-term value for the resin system and shall be verifiable through testing.
- E. When multiple layers are present, the layers of the finished CIPP shall be uniformly bonded. It shall not be possible to separate any two layers with a probe or point of a knife blade so that the layers separate cleanly or such that the knife blade moves freely between the layers. If separation of the layers occurs during testing of the field samples, new samples will be cut from the work. The composite of the materials will, upon installation inside the host pipe, exceed the minimum test standards specified by the American Society for Testing Methods. The CIPP design for the lateral tube shall assume no bonding to the original pipe, in accordance with ASTM F1216. Any reoccurrence may be cause for rejection of the work. The cured liner shall meet TABLE 02771 - 1 Minimum Physical Properties.

**Table 02771 - 1
Minimum Physical Properties**

Property	Standard	PSI
Tensile Strength	ASTM D638	4,000
Flexural Strength	ASTM D790	5,000
Flexural Modulus of Elasticity	ASTM D790	400,000
Modulus of Elasticity	ASTM D2990	150,000
Minimum Long-Term is 50-years		

2.03 CURED-IN-PLACE LINER

- A. All cured-in-place lining products shall comply with ASTM F-1216 or intent thereof as determined by the County.
- B. The flexible tube shall be fabricated to a size that when installed will neatly fit (minimum 99.75%) the internal circumference of the existing sanitary sewer lines (including services). Allowance shall be made for circumferential stretching during insertion so that the final cured product is snug against the wall of the host pipe.

- C. Unless otherwise specified, the Contractor will use a polyester filter felt tube and a resin and catalyst system compatible with the inversion process and having the physical properties for the cured pipe identified in Table 02771 - 1 Physical Properties.
- D. Resin Components
1. The resin system shall be a corrosion resistant epoxy vinyl ester or polyester that when properly cured within the tube composite meets the minimum requirements given herein or those that are to be utilized in the design of the CIPP for this project. The catalyst system may be accelerated to promote curing.
 2. The resin used shall not contain non-strength enhancing fillers.
 3. The Contractor shall submit the resin characteristics, including filler identification, to the County for approval prior to lining activities.
- E. CIPP liner systems using resins containing styrene or other regulated chemicals that will be discharged into the wastewater system shall require a pre-treatment plan to remove the regulated chemicals to acceptable levels prior to discharge.
- F. The Contractor shall submit the pre-treatment plan including design calculations to the County for approval prior to discharge. The information required shall include:
1. MSDS for all chemicals used in the process and that will be discharged into the wastewater system.
 2. Representative analytical data that was performed in the past for the proposed process, as collected from the wastewater stream.
 3. The addresses and mapped locations of the discharge.
 4. The total duration of discharge request.
 5. The anticipated discharge temperature. Discharges in excess of 140°F are not permitted.
 6. The Contractor shall submit for approval a summary table of pre-treatment design calculations in Excel containing the following information:
 - a. Dates of discharge of each section
 - b. Lining section numbers using the OCUD numbering system
 - c. Length and diameter of each section
 - d. Volume (in gallons) of inversion water of each section
 - e. Volume (in gallons) of cool down water of each section
 - f. Total volume (in gallons) of inversion and cooling water of each section
 - g. Regulated chemical (in pounds) in discharge volume of each section
 - h. Reduction chemical (in pounds) to meet post-treatment concentration limit
 - i. Reaction time period (in hours) to achieve post-treatment concentration limit
 - j. Cool down time period (in hours)
 - k. Regulated chemical post-treatment concentration limit (in PPM)
 7. The Contractor shall provide pre-treatment and post-treatment sampling and laboratory analysis of the process wastewater and submit the results to the County for verification.

PART 3 - EXECUTION

3.01 PREPARATION

- A. The following installation procedures shall be adhered to unless otherwise approved by the County.
- B. Prior to any lining of a pipe so designated, it shall be the responsibility of the Contractor to remove all internal debris and clean the existing sewer line and/or lateral in accordance with the recommendations of the liner manufacturer and in accordance with Section 02761 "Cleaning Sanitary Sewer Systems." Both mainline and lateral line shall be cleaned.
 - 1. It shall be the responsibility of the Contractor to remove all internal debris and clean the existing sewer line and/or lateral in accordance with the recommendations of the liner manufacturer prior to installation of the liner.
 - a. Preparation of the interior surface shall be accomplished by a thorough high-pressure water-jet cleaning. The pipe shall be left free of all loose sand, rock, or other deleterious materials. Any roots in the pipe shall be either removed or cut off flush with the interior.
 - b. If conditions such as broken pipe and major blockages are found that will prevent proper cleaning or where additional damage would result if cleaning is attempted or continued, the Contractor shall notify the County immediately. The County will determine what course of action will be taken to complete the project.
 - c. Precautions shall be taken by the Contractor to ensure that no damage or flooding of public or private property is caused by the cleaning operation.
 - d. The County shall inspect the prepared pipe for cleanliness and smoothness before the Contractor is authorized to proceed with pipe lining operations.
 - 2. Experienced personnel trained in locating breaks, obstacles and service connections by closed circuit television shall perform inspection of existing sewer lines. The interior of the line shall be carefully inspected in accordance with Section 02762 "Televising Sanitary Sewer Systems" to determine the location of laterals in any condition that may prevent proper installation of the liner pipe into the lines. Such conditions shall be noted so they can be corrected. A digital data video and a suitable log shall be prepared by the Contractor during the Work and provided to the County a minimum of two weeks prior to liner installation.
 - 3. The Contractor shall provide for the flow of sewage around the section or sections of pipe designated for lining as specified in Section 01516 "Collection System Bypass."
 - a. Flow control shall be exercised as required to ensure that no flowing sewage comes into contact with sections of the sewer under repair.
 - b. A sewer line plug shall be inserted into the sewer upstream from the section to be repaired. The plug shall be so designed that all or any portion of the sewage flows can be released. During the review, testing and installation portion of the operation, flows shall be shut off in order to properly install the cured-in-place pipe lining. The upstream manholes shall be constantly monitored for degree of surcharging. After the installation is complete, flows shall be restored to normal level.

- c. Wherever lines are blocked off and the possibility of backing up the sewage and causing harm to public and private property is foreseen, it shall be the Contractor's responsibility to bypass flow from manhole to manhole.
 - d. Bypassing shall be accomplished using sewer plugs with pump connections, by pumping down surcharged manholes, or by other methods acceptable to the County. All bypassed flow must be discharged to a sanitary sewer. Bypassed flow shall not be allowed to enter any storm line, drainage ditch or street gutter.
 - e. During a bypass operation, the pump shall be manned continuously; the Contractor shall maintain the pump and bypass equipment; and shall be responsible for any damages to public or private property due to the malfunction of same.
4. The Contractor shall clear the line of obstructions such as solids, dropped joints, protruding service connections or collapsed pipe that will prevent the insertion of the liner pipe. If inspection reveals an obstruction that cannot be removed by conventional sewer cleaning equipment, then the County shall be notified immediately.
 5. Do not install liner if ground water temperatures and/or ambient temperatures are excessive for the product installation procedures.
 6. Notification of Public or Customers: Customers shall be notified by the Contractor with door hanger advising the customers of when the Work will begin, expected date of completion, the type of work and contact person for any questions.
 7. Traffic Control: The Contractor shall provide all traffic control measures required for the safety of the public, workers and equipment during the Work and in accordance with FDOT and the County.
 8. The contractor shall provide critical backup equipment to insure that the lining operation progresses without interruption. Required backup equipment shall include at a minimum 1 additional lateral cutter system and 1 additional CCTV camera system.

3.02 PRE-TREATMENT OF REGULATED CHEMICALS TO DISCHARGE INTO SEWER

- A. CIPP liner systems using resins containing styrene or other regulated chemicals that will be discharged into the wastewater system shall require a pre-treatment plan to remove the regulated chemicals to acceptable levels prior to discharge. The Contractor shall submit the pre-treatment plan to the County for approval prior to discharge. The information required shall include:
 1. MSDS for all chemicals used in the process and that will be discharged into the wastewater system
 2. Representative analytical data that was performed in the past for the proposed process, as collected from the wastewater stream
 3. The addresses and mapped locations of the discharge
 4. The total duration of discharge request
 5. The anticipated discharge temperature. Discharges in excess of 140°F are not permitted
 6. The Contractor shall submit for approval a summary table of pre-treatment design calculations in Excel containing the following information:
 - a. Dates of discharge of each section

- b. Lining section numbers using the OCUD numbering system
 - c. Length and diameter of each section
 - d. Volume (in gallons) of inversion water of each section
 - e. Volume (in gallons) of cool down water of each section
 - f. Total volume (in gallons) of inversion and cooling water of each section
 - g. Regulated chemical (in pounds) in discharge volume of each section
 - h. Reduction chemical (in pounds) to meet post-treatment concentration limit
 - i. Reaction time period (in hours) to achieve post-treatment concentration limit
 - j. Cool down time period (in hours)
 - k. Regulated chemical post-treatment concentration limit (in PPM)
7. The Contractor shall provide pre-treatment and post-treatment sampling and laboratory analysis of the process wastewater and submit the results to the County for verification.

3.03 INSTALLATION

A. General

1. Alternative methods of liner insertion, pressurization, and processing may be used for products and processes approved by the County, and when the final liner product meets the intent of ASTM installation procedures as determined by the County. Installation shall be in accordance with manufacturer's recommendations, which shall be available for verification by the inspector. Should there be any difference between the requirements, the more stringent shall govern. Prior to construction, the Contractor shall submit to the County such written information which shall include, but not be limited to, storage and handling of liner before installation, preparing liner for installation, installing the liner in the sewer pipe, temperature and pressure requirements for inverting and setting the liner, curing and cool down procedures, end seals and service connections. The Contractor shall also submit to the County, a description of his methods for avoiding liner stoppage due to conflict and friction at such locations as the manhole entrance and the bend into the pipe entrance. The Contractor shall also present plans for dealing with a liner stopped by snagging within the pipe.
2. Seal the area where the line enters or leaves each manhole. Finish the inside of the manhole with a quick set cement grout to raise the invert to the grade of the liner pipe. Also use this grout to dress up around the end of the liner. This space may be sealed with a mechanical seal, chemical seal, or combination of both. The Contractor shall seal the liner at all manhole reconnections with an approved product, compatible with the liner, to completely seal any annular space present.
3. If the pipe liner fails to make a tight seal due to broken or misaligned pipe at the manhole wall or other reason, the Contractor shall apply a seal at that point.
4. The temperature of water discharged to the sewer system from processing liners shall not exceed 100°F maximum or the level allowed by State or Local standards. When draining water, care shall be exercised not to create a vacuum in the line.

5. After the liner has been installed, all active, existing services shall be temporarily reinstated to 100% of the original opening. This shall be done without excavation in pavement areas, and in the case of non-man-entry pipes, from the interior of the pipeline by means of a 360° (degree) television camera and a cutting device that re-establishes the service connection. When a remote cutting device is used and a cleanout is available, then a mini-camera down the service may also be used to assist the operator in cutting or trimming. All coupons shall be recovered at the downstream manhole and removed.
6. The Contractor shall immediately notify the County of any construction delays taking place during the insertion operation. Such delays shall possibly require sampling and testing by an independent laboratory of portions of the cured liner at the County's discretion. The cost of such test shall be borne by the Contractor and no extra compensation will be allowed. Any failure of sample tests or a lack of immediate notification of delay shall be automatic cause for rejection of that part of the Work at the County's discretion.
7. The cost for maintaining sanitary sewer service for the property owners during construction shall be included in the prices bid and no additional compensation will be allowed. Prior to construction, the Contractor shall submit to the County for review a complete description of the methods he intends to use to reconnect the existing laterals.

B. Cured-In-Place Liner

1. The Contractor shall designate a location where the reconstruction tube will be vacuum impregnated prior to installation. The Contractor shall allow the County to inspect the materials and "wet out" procedure. A catalyst system compatible with the resin and reconstruction tube shall be used. Sufficient excess resin will be provided to insure excretion into cracked pipe and or joints of the hot pipe after curing.
2. The wet out reconstruction tube shall be inserted through an existing manhole or other approved access by means of an inversion process, pulled in place process, or other approved method, and the application of a hydrostatic head, or equivalent pressure sufficient to fully extend it to the next designated manhole or termination point. The reconstruction tube shall be inserted into the vertical inversion standpipe with the impermeable plastic membrane side out. At the lower end of the inversion standpipe, the reconstruction tube shall be turned inside out and attached to the standpipe so that a leak proof seal is created. The inversion head will be adjusted to be of sufficient height to cause the impregnated tube to invert from manhole to manhole and hold the tube tight to the pipe wall, produce dimples at side connections and flared ends at the manholes. The use of a lubricant is recommended. Care shall be taken during the elevated curing temperature so as not to overstress the felt fiber.

3. After inversion is completed the Contractor shall supply suitable heat source and recirculation equipment. The equipment shall be capable of delivering the heat source throughout the section uniformly to raise the temperature above the temperature required to affect a cure of the resin. This temperature shall be determined by the resin/catalyst system employed. The system, together with the manufacturer's approval, shall be submitted to the County for review prior to lining operations. Temperatures shall be monitored and recorded throughout the installation process to ensure that each phase of the process is achieved at the manufacturer's recommended temperature levels. Copies of these records shall be given to the County at the completion of each installation.
4. The heat source shall be fitted with suitable monitors to gauge the temperature of the incoming and outgoing heat source. Another such gauge shall be placed between the impregnated reconstruction tube and the pipe invert at the remote manhole to determine the temperatures during cure. The resin manufacturer shall recommend temperature in the line during the cure period.
5. Initial cure shall be deemed to be completed when inspection of the exposed portions of cured pipe appear to be hard and sound and the remote temperature sensor indicates that the temperature is of a magnitude to realize an exotherm. The cure period shall be of a duration recommended by the resin manufacturer, as modified for the cured-in-place inversion process, during which time the recirculation of the heat source and cycling of the heat exchanger to maintain the temperature continues. Contractor shall retain a resin-impregnated sample (wick) to provide verification of the curing process taking place in the host pipe.
6. The Contractor shall cool the hardened pipe to a temperature below 100°F before relieving the static head in the inversion standpipe. Cool-down may be accomplished by the introduction of cool water into the inversion standpipe to replace water being drained and disposed per the approved pre-treatment plan. Care shall be taken in the release of the static head so that a vacuum will not be developed that could damage the newly installed pipe.

C. Service Lateral Renewal

1. The exact location and number of service connections or side sewers shall be verified during the initial television inspection. It shall be the Contractor's responsibility to accurately field locate all existing service connections or side sewers and establish means for access for flow control. The Contractor shall reconnect all service connections or side sewers to the liner pipe as indicated in accordance with the Contract Documents.
2. The Contractor shall be responsible for restoring/correcting, without any delay, all missed or faulty reconnections, as well as any damage caused to property owners for not reconnecting the services soon enough or for not giving notice to the property owners.
3. Any lateral not initially reinstated by the Contractor that proves to be active shall be reinstated by the Contractor at no additional cost to the County and the Contractor shall be responsible for any resulting property damage of floods.

4. All existing service connections shall be reconnected by a remote controlled cutting device directed internally by a television camera or by internal manual cutting. Cuts shall be made by experienced operators so that no blind attempts or holes are made in the liner pipe. Locations shall be verified carefully to match earlier tapes for accurate lateral location, especially where dimples are not well defined. The County reserves the right to require service connection by excavation at the Contractor's expense at any location if the quality or workmanship of the cut is not satisfactory.
5. A 2-pass process of utilizing a cutter to open the lateral followed by wire brush (or similar) attachment to complete the cutting flush with the lateral walls should be utilized, or approved alternate. It shall be properly aligned, invert to invert, to the existing connection with no obstructions to the flow. Resin slugs shall be removed as necessary from reinstated service connections. Any mis-cuts shall be repaired at no cost to the County and shall be performed utilizing an additional thinner liner to prevent water from entering behind the liner to the full satisfaction of the County. All coupons cut from the liner for reopening of lateral connections shall be retrieved from the sewer, accounted for by the Contractor, and turned over to the County.
6. All service connections and side sewers to be reconnected to the main sewer, shall be cleaned up to a length of 1-foot from the inside face of the existing wall of the main pipe. All deposits within the first foot of the service connection or side sewer in the service connections shall be removed and laterals reinstated.
7. Contractor shall provide a sound, smooth transition from laterals/side sewers to the main sewer. Any gaps between the liner and face of lateral/side sewer connections shall be completely filled and sealed with epoxy material compatible with the liner and host pipe. After installation of the liner and reinstatement of the lateral/side sewer, all repaired lateral/side sewer connections shall be sealed with 1/4-inch thickness epoxy material compatible with the liner and repair material from the liner connection to 1-foot from the inside face of the main sewer.
8. For PVC laterals or laterals that have been previously lined with cured-in-place pipe the Contractor shall take care during the reinstatement to avoid damage to the lateral pipe. A 2 pass process of utilizing a cutter to open the lateral followed by wire brush (or similar) attachment to complete the cutting flush with the lateral walls should be utilized, or approved alternate.

3.04 POST INSTALLATION

- A. Where liners of any type are installed in 2 or more continuous manhole segments, the liner invert through the intermediate manholes shall be left intact. Final finishing of the installation in those intermediate manholes shall require removal of the top of the exposed liner and neat trimming of the liner edge where it touches the lip of the manhole bench.
- B. Portions of any piece of liner material removed during installation shall be available for inspection and retention by the County.

- C. Reinstate openings for all drop assemblies after relining mainline sewer. Everywhere possible, outside drop assemblies shall be lined with a cured-in-place liner compatible with the mainline liner, for the full length of the drop assembly and bend. The vertical pipe shall be lined, at a minimum. Drop assemblies inside of manholes are not required to be relined, unless directed by the County.
- D. Each line segment lined shall be TV inspected in accordance with Section 02762 "Televising Sanitary Sewer Systems" as soon as practical after processing to assure complete curing. The liner shall be continuous and free of all visual and material defects except those resulting from pre-lined conditions (such conditions shall be brought to the attention of the County prior to lining). There shall be no damage, deflection, holes, delaminating, uncured resin or other visual defects in the liner. The liner surface shall be smooth and free of waviness throughout the pipe. No visible leakage through the liner or at manhole or service lateral connections will be allowed. Any defects located during the inspection shall be corrected by the Contractor to conform to the requirements of the specifications and to the satisfaction of the County. The Contractor shall not reactivate any section of lined sewer pipe until authorized to do so by the County. Segments not fully conforming to these Specifications must be immediately brought to the County's attention with a proposed method of correction.

3.05 TESTING

- A. After completing the lining, service renewals where required, and manhole rehabilitation/replacement, every liner and manhole shall be CCTV inspected as per Section 02762 "Televising Sanitary Sewer Systems."
- B. The Contractor shall have an independent testing lab analyze finished liner samples taken from manhole cutoffs, service coupons, etc.
 - 1. A minimum of 1 sample shall be taken of the first segment installed, or as directed by the County.
 - 2. A minimum of 2 samples shall be taken for each 2,500 lineal feet of liner material installed or for each manufacturing lot, if less, or as directed by the County.
 - 3. A minimum of 6 samples per project shall be taken for each type of liner furnished, or as directed by the County.
 - 4. Tests in accordance with ASTM standards for Tensile Properties, Flexural Modulus and wall thickness shall be conducted.
 - 5. The Contractor shall determine sampling location and procedures to ensure representative samples are obtained from the finished liner, subject to approval by the County.
 - 6. The Contractor shall furnish removable sizing sleeves, when possible, to collect liner samples, which accurately replicate the host pipe diameter.

3.06 ACCEPTANCE

- A. It is the intent of these specifications that the completed liner with all appurtenances shall be essentially equivalent in final quality and appearance to new sewer installation.

- B. The finished liner shall be continuous over the entire segment between manholes and homogenous throughout.
- C. The finished liner shall be fully rounded and as free as commercially practicable from visible defects, including but not limited to damage, deflection, holes, delamination, ridges, cracks, uncured resin, foreign inclusions or other objectionable defects.
- D. There shall be no visible infiltration through the liner, around the liner at manhole connections, at lined service connections or in lined services. Contractor shall repair any visible leaks.
- E. Where a defect in the liner requires removal of a section of the liner in the County's opinion, the Contractor shall make all repairs as required by the County and shall install a segmental liner, compatible with the liner, to accomplish a continuous finished liner. No separate payment will be made for such defect repair or for the post-repair segmental liner.
- F. The pipe shall be neatly and smoothly cut off at each manhole. The manhole trough shall be raised to the invert of the liner to preclude snagging and shoaling of debris.
- G. Service Connections
 1. The CIPP lateral lining shall not inhibit the CCTV post video inspection of the mainline or service lateral pipes.
 2. Reinstatement of all building sewer connections shall be done neatly and smoothly.
 3. The Contractor shall install any missing clean outs at the road right-of-way.

3.07 CLEAN-UP AND RESTORATION

- A. The Contractor shall not allow the site of the Work to become littered with trash and waste material, but shall maintain the site in a neat and orderly condition throughout the construction period.
- B. On or before completion, the Contractor shall clean and remove from the site of the Work all surplus and discarded materials, temporary structures, stumps and portions of trees, and debris of any kind. He shall leave the site of work in a neat and orderly condition, similar or equal to that prior to construction.
- C. All private and public property along or adjacent to the Work disturbed by construction operations shall be restored to a condition similar or equal to that existing prior to construction.
- D. Before final acceptance by the County, the Contractor shall replace and/or restore any water, sewer, drain, and gas lines and appurtenances; electrical, telephone, telegraph conduits and wires, both underground and aboveground, and appurtenances; traffic signals, fire and police alarm systems and appurtenances; sidewalks, curbs, gutter, drainage ditches and pavements and all other public utility facilities and appurtenances along or adjacent to the Work that may have been disturbed by construction operations.

- E. Conditions permitting, property cleanup and restoration shall begin and be prosecuted to completion on a timely basis as set forth herein.

3.08 PRIVATE SEWER LATERAL SHUTDOWN

- A. When it is necessary to shutdown a private sewer lateral while work is in progress and before the laterals are reconnected, the residents are to be notified by the Contractor at least 1-day prior to the shutdown. No sewer or water service is to remain shutdown for more than a period of 8-hours unless the Contractor provides substitute services for the residents. Commercial sewer services shall be maintained at all times that the business is open. No sewage from the services or main line shall be discharged on the ground or in waterways. Holding pits or tanks are not allowed unless permitted by the State. Contractor shall coordinate pump stations, force main and sanitary sewer operation, bypass and shutdown control with the County.

3.09 PROSECUTION OF WORK

- A. The Contractor is cautioned that only those sewer services that are live and active shall be repaired or reinstated after the sewer main has been lined or replaced.
- B. The Contractor shall note that not all sewer lines segments have been televised in their entirety due to obstructions blocking further entry, etc. These obstructions shall be cleared to allow TV viewing of the entire segment length before lining is commenced.
- C. The number of service connections on some sewer segments may exceed the number of buildings actually served. It is the Contractor's responsibility to determine through dye testing, or other acceptable methods, the services that are live and require reinstatement prior to commencing lining of the sewer main. Services that are confirmed to be inactive shall not be reconnected. Services that are inactive, but reinstated, shall be plugged at the Contractor's expense.
- D. Inactive services to vacant parcels shall be renewed, unless otherwise directed by the County.

3.10 WARRANTY INSPECTION

- A. The County shall conduct the warranty television inspection within 1-year after the date of acceptance. Any defective sections of liner located during the inspection shall be promptly repaired or replaced by the Contractor as directed by the County. In the event that a sewer liner or service connection is found to be leaking during the inspection, the Contractor shall be required to promptly replace it with a new section of pipe or liner or, if approved by the County, to eliminate the leak(s) by other means of repair.

END OF SECTION

THIS PAGE LEFT BLANK INTENTIONALLY

SECTION 02774
WASTEWATER GRAVITY COLLECTION SYSTEM

PART 1 - GENERAL

1.01 DESCRIPTION

- A. Scope of Work: Construction of sanitary sewers, sewer connections and appurtenances as shown on the Drawings or specified herein.

1.02 QUALITY ASSURANCE

- A. Storage: PVC pipe shall be stored on level ground, preferably turf or sand, free of sharp objects which could damage the pipe. Stacking of the PVC pipe shall be limited to a height that will not cause excessive deformation of the bottom layers of pipes. Where necessary, due to ground conditions, the pipe shall be stored on wooden sleepers, spaced suitably and of such width as not to allow deformation of the pipe at the point of contact with the sleeper or between supports.
- B. Tests: Certified records of tests made by the manufacturer or by a reliable commercial laboratory shall be submitted with each shipment of pipe. All pipe shall be inspected upon delivery and that which does not conform to the requirements of these specifications shall be rejected and must be immediately removed by the Contractor. The Contractor shall furnish and provide samples of pipe for the performance of such additional tests as the County may deem necessary.

1.03 SHOP DRAWINGS AND SUBMITTALS

- A. Submittals shall be submitted to the County for review and acceptance prior to construction in accordance with the General Conditions and specifications Section 01300 "Submittals."
 - 1. Precast manholes
 - 2. Manhole frames, covers, and other castings
 - 3. Manufacturer's certified test report on castings
 - 4. Certification of admix installation from pre-caster
 - 5. Certified test records for polyvinyl chloride pipe
 - 6. Mill Test Certificates on ductile iron pipe
 - 7. Manhole pipe connections
 - 8. Coal tar epoxy
 - 9. Special interior linings
- B. Record Information: The Contractor shall submit to the County the elevations of the center of the manhole covers and inverts of all pipes in the manholes.

PART 2 - PRODUCTS

2.01 GENERAL

- A. All material supplied shall be one of the products specified in Appendix D "List of Approved Products" appended to these technical specifications.

2.02 MATERIALS

- A. Ductile Iron Pipe and Fittings: Ductile iron pipe shall meet the requirements of Section 15062 "Ductile Iron Pipe and Fittings."
- B. Polyvinyl Chloride Pipe and Fittings: Polyvinyl Chloride (PVC) Pipe shall meet the requirements of Section 15064 "Polyvinyl Chloride Pipe and Fittings."
- C. Precast Concrete Manholes
 - 1. Precast manholes shall conform to the requirements of ASTM Designation C 478.
 - a. The minimum shell thickness shall be 5-inches.
 - b. Lifting holes through the structures are not permitted.
 - c. The design of the structure shall include a precast base of not less than 8-inches in thickness poured monolithically with the bottom section of the manhole walls.
 - d. Where drop structures are required, the design of the structure shall include a precast base, for the drop structure, of not less than 8-inches in thickness poured monolithically with the bottom section of the manhole walls.
 - e. New manholes shall contain a crystalline waterproofing concrete admix. Crystalline waterproofing concrete admix shall be added to the concrete during the batching operation. Admix concentration shall be added based upon manufacturer design percent concentration of admixture to the required weight of cement. The amount of cement shall remain the same and not be reduced. A colorant shall be added to verify the admix was added to the concrete for all precast manholes. Colorant shall be added and provided at the admix manufacturing facility, not at the concrete batch plant. Contractor shall provide certification from the pre-caster that the admix was installed in accordance with the manufacturers recommendations.
 - 2. Top sections shall be eccentric, except that concrete top slab shall be used where shallow cover requires a top section less than 3-feet deep.
 - 3. New manholes shall be lined with Interior Linings where shown on the Drawings.
- D. Concrete and Reinforcing Steel: Concrete and reinforcing steel shall conform to the requirements of Division 3 - Concrete. Concrete classes for the various purposes shall be as follows:
 - 1. Manhole bottoms, Class A
 - 2. Precast manholes, Class A (4,000-psi)
 - 3. Pipe and riser encasement, Class C
 - 4. Protective slabs, Class C

- E. Castings: Gray iron castings for manhole frames, covers, adjustment rings, and other items shall conform to the ASTM Designation A 48, Class 30. Castings shall be true to pattern in form and dimensions and free of pouring faults and other defects in positions which would impair their strength, or otherwise make them unfit for the service intended. No plugging or filling will be allowed. Lifting or "pick" holes shall be provided, but shall not penetrate the cover. Casting patterns shall conform to those shown or indicated on the Drawings. The words SANITARY and ORANGE COUNTY, FLORIDA shall be cast in all manhole covers as shown on the Drawings. All manhole frames and covers shall be traffic bearing to meet AASHTO H-20 loadings unless otherwise specified.
- F. Brick: Brick for manhole construction shall be dense, hard burned, shale, or clay brick conforming to ASTM Designation C 32, Grade MM or C 62, Grade MW, except that brick absorption shall be between 5 and 25-grams of water absorbed in 1-minute by dried brick, set flat face down, in 1/8-inch of water.
- G. Cement Mortar: Cement mortar for manhole construction shall comply with ASTM Designation C 270, Type M, except that the cement shall be Portland Type II only. No mortars that have stood for more than 1-hour shall be used.
- H. Pipe Adapter: Connection of PVC gravity sewer lines to precast manholes and wetwells shall be made by using a flexible boot type manhole coupling adapter.
- I. Interior Linings (existing structures): Interior surfaces of existing manholes and wetwells shall be coated or lined to resist corrosion where shown on the Drawings. Coatings and linings shall meet the requirements of Section 09901 Coatings and Linings.
- J. Interior Linings (proposed structures): Interior surfaces of new wetwells shall be lined. Interior surfaces of new manholes shall be lined where shown on the Drawings. Coatings and linings shall meet the requirements of Section 09901 Coatings and Linings.
- K. Joint Sealer: Joint sealer material for precast manhole structures shall be pre-formed flexible plastic conforming to Federal Specification SS-S-00210 (GSA-FSS). Seal all exterior joints with Portland Type II cement after setting of joint sealer and placement of manhole section to form a watertight joint.
- L. Non-Shrink Mortar: Non-shrink mortar shall be used for filling annular spaces and holes in precast manholes and wetwells.
- M. Manhole Encapsulation: Manhole cones, riser rings, iron frame, cover, and all joints shall be encapsulated with a heat shrink-wrap with a minimum thickness of 98-mils (2.5-mm).
 - 1. Wrap shall have a cross-linked polyolefin backing coated with a protective heat activated adhesive. The wrap shall effectively bond to the substrate via primer provided by the manufacturer. The wrap shall be applied with a high intensity propane torch.
 - 2. Heat shrink-wrap for all barrel section joints of manholes shall be a minimum 9-inch width. Corbel section, riser rings, and ring and cover shall have a minimum 12-inch width wrap.
 - 3. Adhesive tap materials shall not be allowed.

PART 3 - EXECUTION

3.01 PREPARATION

- A. Upon satisfactory excavation of the pipe trench, as specified in Section 02220 "Excavating, Backfilling and Compacting" a continuous trough for the pipe barrel and recesses for the pipe bells shall be excavated by hand digging so that, when the pipe is laid in the trench, true to line and grade, the pipe barrel will receive continuous uniform support and the bell will receive no pressure from the trench bottom.
- B. The interior of all pipe shall be thoroughly cleaned of all foreign material before being lowered in the trench and shall be kept clean during laying operations by means of plugs or other approved methods.

3.02 INSTALLATION

A. Sewer Pipe

1. General

- a. Laying of pipe shall proceed upgrade with spigot ends pointing in the direction of flow. Before pipe is joined, gaskets shall be cleaned of all dirt, stones, and other foreign material. The spigot ends of the pipe and/or pipe gaskets shall be lubricated lightly with a lubricant as specified by the pipe manufacturer and approved by the County. Sufficient pressure shall be applied to the pipe so as to properly seat the socket into the bell of the pipe. Any damage to the pipe due to over-exertion shall be replaced at the Contractor's expense. All pipe shall be laid straight, true to the lines and grades shown on the Drawings.
- b. Variance from established line and grade, at any point along the length of the pipe, shall not be greater than 1/32-inch per inch of pipe diameter and not to exceed 1/2-inch, provided that any such variation does not result in a level or reverse sloping invert.
- c. Any pipe, which is disturbed or found to be defective after installation, shall be taken up and relayed or replaced at the Contractor's expense.
- d. Approved utility crossing signs shall be placed on the pipe alignment at each side of any waterway crossing.

2. PVC Pipe

- a. Handling PVC pipe: The handling of PVC pipe shall be in such a manner that the pipe is not damaged by dragging it over sharp and cutting objects. Sections of pipe with deep cuts and gouges shall be removed and discarded at no expense to the County.
- b. Lowering pipe into trench: Care shall be exercised when lowering pipe into the trench to prevent damage to or twisting of the pipe.

3. Building Laterals/Service Connections

- a. Service connections shall be constructed in accordance with the details as indicated on the Drawings.
- b. Sewer lateral pipe shall be extended to the right-of-way and plugged at the right-of-way line to avoid leakage (unless otherwise indicated on the Drawings). All connections and changes of direction shall be made using standard fittings designed for that purpose.
- c. Locator balls shall be placed under all sanitary sewer service cleanouts.

- d. On curbed streets, the exact location for each service connection shall be marked by etching or cutting an "S" in the concrete curb. Where no curb exists or is planned, locations shall be marked by a method approved by the County.
4. PVC C-900 DR 14 Pipe Section: PVC C-900 DR 14 pipe shall be substituted for the specified PVC pipe where:
 - a. The sewer or service pipe is to be constructed with less than 30-inches of cover between the top of the pipe and the final top of pavement or ground line.
 - b. The PVC sewer main crosses over a water main, or is at a depth which results in less than 18-inches clear distance between pipes when crossing under a water main. The DR 14 pipe shall extend a minimum of 10-feet on each side of the point of crossing.
 - c. The lateral separation of the sewer pipe and potable water piping is less than 10-feet.

B. Manholes:

1. Manhole excavation and bedding at manhole junctions shall be performed in accordance with the provisions of Section 02220 "Excavating, Backfilling and Compacting" of these specifications.
2. The invert channels shall be smooth and accurately shaped to a semicircular bottom conforming to the inside of the adjacent sewer section using 2,500-psi concrete. Steep slopes outside the invert channels shall be avoided. Changes in size and grade shall be made gradually and evenly. Changes in the direction of the sewer or entering branch shall be a smooth curve with radius as long as practicable. Invert channels shall also be formed for pipe stubouts.
3. The first pipe joint outside the manhole shall be located a minimum distance of 24-inches from the outside surface of the manhole.
4. Precast manhole tops shall terminate at such elevations to permit laying brick courses under the manhole frame to make allowance for future street grade adjustments.
5. Frames and covers shall be set accurately to conform to the finished grade.
6. Outside drop connections shall be made in accordance with the details shown on the Drawings.
7. Drop connection base slab extensions on precast manholes shall be manufactured monolithically with the manhole elements at the casting yard. The manufacturer shall submit for approval the method of drop manhole construction.
8. Where additional pipe connections or modifications of existing factory made openings are required on new or existing precast concrete manholes or wetwells, all cutting relative thereto shall be performed only by a power driven abrasive wheel or saw. It is specifically noted that such connections to existing manholes or wetwells shall be installed in accordance with the details for new units shown on the Drawings, and shall be caulked watertight with non-shrink grout.
9. Connection of the pipe entering the manhole shall be made by using a flexible boot type manhole coupling adapter. At the entry into the manhole, no part of the horizontal pipe shall rest against the concrete.
10. Manholes shall be completed as the work progresses so that testing may be conducted as prescribed in paragraph 3.03 Field Quality Control.

- C. Concrete encasement: Class C concrete encasement shall be constructed in accordance with details shown on the Drawings.

1. The County may order the line encased when:
 - a. The sewer main crosses over a water main, or is at a depth which results in less than 18-inches clear distance between pipes when crossing under a water main. Encasement shall extend a minimum of 10-feet on each side of the point of crossing. In lieu of encasement, the sewer line may be constructed of PVC DR 14 pipe and shall be laid such that both joints will be a distance of 10-feet from the crossing.
 - b. The maximum width for trench excavations is exceeded. The Contractor shall construct concrete encasement around the pipe for the length of the excessive excavation. No payment will be made for the concrete encasement required due to excessive trench widths.
2. The points of beginning and ending of pipe encasement shall be not more than 6-inches from a pipe joint to protect the pipe from cracking due to uneven settlement of its foundation or the effects of superimposed live loads.

D. Concrete protective slabs: Concrete protective slabs as shown on the Drawings shall be constructed over gravity sewers that have less than 3-feet of cover from finished grade.

E. Connections to existing structures: Proposed sewer lines shall be connected to the existing manholes by core drilling the proper size opening and installing a flexible boot type manhole adapter as specified in paragraph 2.01.H of this Section.

F. Invert channels (benching) shall be provided for all new manholes and existing manholes which are connected into. No brick shall be allowed in construction of the manhole invert. Inverts shall be poured using 2,500-psi concrete.

3.03 FIELD QUALITY CONTROL

A. Workmanship: Sewers and appurtenances shall be built watertight. The sewage must be pumped for disposal and special care and attention must be paid to securing watertight construction. Upon completion, the sewers, or sections thereof, will be tested and gauged and if leakage is above the allowable limits specified, the sewer will be rejected.

B. Inspection: On completion of each block or section of sewer, or such other times as the County may direct, the block or section of sewer shall be cleaned, tested, and inspected.

1. Each section of the sewer shall show, on examination from either end, a full circle of light between manholes.
2. Each manhole or other appurtenance to the system shall be of the specified size and form, be watertight (no leakage allowed by visual inspection), and be constructed with the top set permanently to specified position and grade. All repairs shown necessary by the inspection shall be made; broken or cracked pipe replaced; all deposits removed and the sewer left true to line and grade, entirely clean and ready for use.
3. No pipe shall exceed a deflection of 5%. After the final backfill has been in place at least 30-days, the Contractor shall perform deflection testing using a rigid ball or mandrel with a diameter of not less than 95% of the base inside diameter or average inside diameter of the pipe, depending which is specified in the ASTM standard to which the pipe is manufactured. If the mandrel does not pass the completed section of sewer, the entire section of sewer will be rejected.

C. Closed Circuit Television Inspection:

1. Internal gravity sewer video inspection shall be performed by the Contractor to check for alignment and deflection. The television inspection shall also be used to check for cracked, broken, or otherwise defective pipe and overall pipe integrity.
2. The video internal inspection will be performed in 2 stages. The first inspection shall be within 30-days after the installation of the gravity sewer pipe provided the road base is in place and the manhole rings and covers are to grade. The second inspection of the gravity sewer pipe shall be before the end of the 1-year warranty period.
3. If the first or second video inspection reveals cracked, broken, or defective pipe, or pipe misalignment resulting in vertical sags in excess of 1-1/2-inch or a ring deflection in excess of 5%, the Contractor shall be required to repair or replace the pipeline. Successful passage of both the low-pressure air exfiltration test and video inspection is required before acceptance by the County.
4. Prior to repair or replacement of failed sewer pipe, the method of repair or replacement shall be submitted to the County for approval. Pressure grouting of pipe or manholes shall not be considered as an acceptable method of repair.

D. Low Pressure Air Exfiltration Testing:

1. The Contractor shall provide all labor, equipment, and materials and shall conduct all testing required under the direction of the County
2. Low pressure air testing shall conform to the requirements of UNI-B6-79 "Recommend Practice for Low-Pressure Air Testing of Installed Sewer Pipe", as published by UNI-Bell Plastic Pipe Association.
3. During sewer Construction, all service laterals, stubs, and fittings into the sewer test section shall be properly capped or plugged so as not to allow for air loss that could cause an erroneous air test result. Where necessary, the Contractor shall restrain caps, plugs, or short pipe lengths such that blowouts are prevented.
4. Each test section shall not exceed 400-feet in length and shall be tested between adjacent manholes.
5. Before testing, Contractor shall install monitoring wells at each manhole to determine groundwater level and adjust test pressure accordingly. In no case shall the test pressure exceed 9.0-psig. All pressurizing equipment shall include a regulator or relief valve set no higher than 9.0-psig to avoid over-pressurizing.
6. Low-pressure air shall be slowly introduced into the sealed line until the internal air pressure reaches 4.0-psig greater than the average backpressure of any groundwater above the invert of the pipe, but not greater than 9.0-psig.
7. When temperatures have been equalized and pressure stabilized at 4.0-psig greater than the average groundwater backpressure, the air hose from the control panel to the air supply shall be shut off or disconnected. The continuous monitoring pressure gauge shall then be observed while the pressure is decreased to no less than 3.5-psig greater than the average groundwater backpressure. At a reading of 3.5-psig greater than the average groundwater backpressure, timing shall commence with a stopwatch or other timing device that is at least 99.8% accurate.
8. If the time shown in the table, for the designated pipe size and length, elapses before the air pressure drops 1-psig; the section under-going test shall have passed. The test may be discontinued once the prescribed time has elapsed.

9. If the pressure drops 1-psig before the appropriate time shown in the table has elapsed, the air loss rate shall be considered excessive and the section of pipe has failed the test.
10. Should the section fail to meet test requirements, the Contractor shall determine the source or sources of leakage, and make all necessary repairs and shall repeat the test until the test section is within established limits. All corrective work shall be at the Contractor's expense.

E. Correction of Non-Conforming work:

1. All non-conforming work shall be repaired or replaced by the Contractor at no additional expense to the County. Non-conforming work shall be defined as failure to adhere to any specified or implied directive of these technical special provisions and/or the Drawings, including but not limited to pipe not laid straight, true to the lines and grades as shown on the Drawings, damaged or unacceptable materials, misalignment or diameter ring deflection in pipe due to bedding or backfilling, water standing in any pipe segment or structure, visible or detectable leakage, and failure to pass any specified test or inspection.

**Table 02774-1
Test Time Table**

TEST TIME: For sewer diameter between 8 inches and 36 inches inclusive, the pipe shall be tested between adjacent manholes. The test time for the air pressure to drop the specified one pound shall be as listed below:											
SPECIFICATION TIME REQUIRED FOR A 1.0 PSIG PRESSURE DROP											
1 Pipe Dia. (in.)	2 Minimum Time (min:sec)	3 Length for Minimum Time (ft)	4 Time for Longer Length (sec)	Feet							
				100	150	200	250	300	350	400	450
6	5:40	398	0.854 L	5:40	5:40	5:40	5:40	5:40	5:40	5:42	6:24
8	7:34	298	1.520 L	7:34	7:34	7:34	7:34	7:36	8:52	10:08	11:24
10	9:26	239	2.374 L	9:26	9:26	9:26	9:53	11:52	13:51	15:49	17:48
12	11:20	199	3.148 L	11:20	11:20	11:24	14:15	17:05	19:56	22:47	25:38
15	14:10	159	5.342 L	14:10	14:10	17:48	22:15	26:42	31:09	35:36	40:04
18	17:00	133	7.692 L	17:00	19:13	25:38	32:03	38:27	44:52	51:16	57:41
21	19:50	114	10.470 L	19:50	26:10	34:54	43:37	52:21	61:00	69:48	78:31
24	22:40	99	13.674 L	22:47	34:11	45:34	56:58	68:22	79:46	91:10	102:33
27	25:30	88	17.306 L	28:51	43:16	57:41	72:07	86:32	100:57	115:22	129:48
30	28:20	80	21.366 L	35:37	53:26	71:13	89:02	106:50	124:38	142:26	160:15
36	34:00	66	30.768 L	51:17	76:55	102:34	128:12	153:50	179:29	205:07	230:46

END OF SECTION

SECTION 02775
WASTEWATER MANHOLE REHABILITATION

PART 1 - GENERAL

1.01 DESCRIPTION

- A. Scope of Work: Sanitary sewer manhole rehabilitation including:
 - 1. Rehabilitation and leak proofing of manholes by coating with spray applied or centrifugally cast light-weight structural reinforced concrete, spray applied epoxy resin systems, or equal as determined by County.
 - 2. The repair and sealing of the manhole base, invert, walls, corbel/cone, and chimney of brick, block, or precast manholes, including the removal of any unsound material.
 - 3. The inspection and testing of the various types of work to insure compliance.

1.02 REFERENCES

- A. Codes, Specifications, and Standards (Not Used)
- B. Testing and Materials Standards
 - 1. American Society of Testing and Materials (ASTM)
- C. Related Sections
 - 1. Section 01516 "Collection System Bypass"
 - 2. Section 02774 "Wastewater Gravity Collection Systems"

1.03 DEFINITIONS (NOT USED)

1.04 RESPONSIBILITY FOR OVERFLOWS AND SPILLS

- A. It shall be the responsibility of the Contractor to schedule and perform his work so as to result in no overflows or spills of sewage from the system. If sewage flows are such that they interfere with the Contractor's ability to perform work, the Contractor shall be responsible for scheduling his work during low flow periods or provide bypass pumping. Bypass pumping shall be provided only with the specific written approval of the County.
- B. In the event of overflows caused by the Contractor's work activities, the Contractor shall immediately take appropriate action to contain and stop the overflow, clean up the spillage, disinfect the area affected by the spill, and notify County in a timely manner.

- C. Contractor will indemnify and hold harmless the County for any fines or third-party claims for personal or property damage arising out of a spill or overflow that is fully or partially the responsibility of the Contractor. Should fines subsequently be imposed as a result of any overflow for which the Contractor is fully or partially responsible, the Contractor shall pay all such fines and all of the County's legal, engineering, and administrative costs in defending such fines and claims associated with the overflow.

1.05 SHOP DRAWINGS AND SUBMITTALS

- A. Shop Drawings shall be submitted to the County for review and acceptance prior to starting construction in accordance with the General Conditions and 01300 "Submittals" for the following:
 - 1. Manhole Coating
- B. Submittals shall be submitted to the County for review and acceptance at least 14-days prior to starting manhole rehabilitation in accordance with the General Conditions and Division 1 for the following:
 - 1. Manufacturers' Certificate of Compliance certifying compliance with the applicable Specifications and Standards. The certifications shall list all materials furnished under this Section.
 - 2. Certified copies of factory tests required by the applicable Standards, the Manufacturer, and this Section.
 - 3. Manufacturer's handling, storage, and installation instructions and procedures.
 - 4. Recommended coating thickness design to withstand groundwater pressure as specified in Part 3 of this Section.

PART 2 - PRODUCTS

2.01 GENERAL

- A. Materials
 - 1. All materials furnished for this work shall be in accordance with the "List of Materials and Approved Manufacturers" as appended to these Specifications.
 - 2. The materials used shall be designed, manufactured, and intended for sewer manhole rehabilitation and the specific application in which they are used. The materials shall have a proven history of performance in sewer manhole rehabilitation. The materials shall be delivered to the job site in original unopened packages clearly labeled with the manufacturer's identification and printed instructions. All materials shall be stored and handled in accordance with recommendations of the manufacturer. All materials shall be mixed and applied in accordance with the manufacturer's written instructions.
 - 3. The Contractor shall warrant and hold harmless the County against all claims for patent infringement and any loss thereof.
 - 4. Handle and store all materials and dispose of all wastes in accordance with applicable regulations.

5. Each coating system shall be designed for application over wet surfaces (but not active running water) without degradation of the final product and/or the bond between the product and the manhole surfaces.
- B. The following shall be used for stopping active leaks in concrete and masonry manholes:
1. A premixed fast-setting, volume-stable waterproof cement plug consisting of hydraulic cement, graded silica aggregates, special plasticizing, and accelerating agents. It shall not contain chlorides, gypsum's, plasters, iron particles, aluminum powder, or gas-forming agents, or promote the corrosion of steel it may come in contact with. Set time shall be approximately 1-minute. Ten (10) minute compressive strength shall be approximately 500-psi.
 2. A silicate-based liquid accelerator field mixed with neat Portland cement. The set time shall be approximately 1-minute.
 3. The elastomeric polyurethane resin-soaked method, using dry twisted jute oakum, or resin-rod with polyurethane resin (water activated).
- C. The following shall be used for patching, repointing, filling, and repairing non-leaking holes, cracks, and spalls in concrete and masonry manholes:
1. A premixed non-shrink cement-based patching material consisting of hydraulic cement, graded silica aggregates, special plasticizing and accelerating agents, which has been formulated for vertical or overhead use. It shall not contain chlorides, gypsums, plasters, iron particles, aluminum powder, or gas-forming agents or promote the corrosion of steel with which it may come into contact. Set time (ASTM C-191) shall be less than 30-minutes. One-hour compressive strength (ASTM C-109) shall be a minimum of 200-psi and the ultimate compressive strengths (ASTM C-882-Modified) shall be a minimum of 1,700-psi.
- D. Spray applied or centrifugally cast structural reinforced cement manhole coating
1. The material applied to the surface of the manhole shall be a cementitious blend of calcium aluminate cement and manufactured calcium aluminate aggregates for constructing a coating that is impervious to the flow of water, is resistant to sulfide attack, and restores structural integrity to existing manhole walls.
 2. A monolithic coating shall be formed which covers all interior manhole surfaces and shall have the following minimum requirements at 28-days:

Compressive Strength (ASTM C-579B)	3,000-psi
Tensile Strength (ASTM C-496)	300-psi
Flexural Strength (ASTM C-293) (Modified)	600-psi
Shrinkage (ASTM C-596)	0% at 90% R.H.
Bond (ASTM C-321)	130-psi
Density, when applied	105± pcf
- E. Spray applied epoxy resin system manhole coating.
1. The material sprayed onto the surface of the manhole shall be an epoxy resin system formulated for application within a sanitary sewer environment. The resin will exhibit suitable corrosion resistance and enhance the structural integrity of the existing manhole.

F. Multi-component stress skin panel coating system.

1. The material applied onto the surface of the manhole shall be a multi-component stress skin panel coating system designed to withstand the effects of hydrogen sulfide without any deterioration to the coating. The coating shall be a solvent free, two-component polymeric, moisture/chemical barrier specifically developed for the wastewater environment.
2. The cured epoxy resin system shall conform to the following minimum Structural Standards:

Table 02775-1
Minimum Structural Standards

Cured Product	Test Method	Results
Tensile Stress	ASTM D-638	7,000-psi
Flexural Stress	ASTM D-790	13,000-psi
Flexural Modulus	ASTM D-790	500,000-psi
Compressive Strength	ASTM D-695	13,000-psi

PART 3 - EXECUTION

3.01 REHABILITATION OF MANHOLE STRUCTURE

A. General Procedures

1. Safety: The Contractor shall perform all work in strict accordance with all applicable OSHA, state, local, and manufacturer's safety standards. Each method of manhole rehabilitation in this Section requires some degree of manhole entry by workers. Particular attention is drawn to those safety requirements regarding confined space entry and respiratory protection from airborne particulate materials during cleaning, product mixing, and application.
2. Cleaning: All concrete and masonry surfaces to be rehabilitated shall be clean. All grease, oil, laitance, coatings, loose bricks, mortar, unsound brick or concrete, and other foreign materials shall be completely removed. Water blasting utilizing a 210°F steam unit and proper nozzles shall be the primary method of cleaning; however, other methods such as wet or dry sandblasting, acid wash, concrete cleaners, degreasers, or mechanical means may be required to properly clean the surface. All surfaces on which these methods are used shall be thoroughly rinsed, scrubbed, and neutralized to remove cleaning agents and their reactant products. Debris resulting from cleaning shall be removed from the manhole and not discharged downstream.
3. Stopping Infiltration: After surface preparation and prior to the application of mortars and coatings, infiltration shall be stopped either by plugging with a waterstop compound or chemical grout sealing.
4. Patching: All large holes or voids around joints, or pipes and all spalled areas and all holes caused by missing or cracked brick shall be patched. All missing mortar shall be repointed using a non-shrink patching mortar. All cracked or disintegrated material shall be removed from the area to be patched or repointed, exposing a sound sub base. All cracks not subject to movement and greater than 1/16-inch in width shall be routed out to a minimum width and depth of 1/2-inch and patched with non-shrink patching mortar.

5. Flow Control: The Contractor shall be responsible for plugging or diverting the flow of sewage as needed for repair and coating of manhole inverts and benches.
6. Remove all loose grout and rubble from existing channel. Rebuild channel if required by reshaping and repairing slope of shelves or benches. Work shall include aligning inflow and outflow ports in such a manner as to prevent the deposition of solids at the transition point. All inverts shall follow the grades of the pipe entering the manhole. Changes in direction of the sewer and entering branch or branches shall have a true curve with the largest possible radius and shall be shaped to allow easy entrance of maintenance equipment including buckets or T.V. camera.
7. Each coating system shall be installed in accordance with the manufacturer's recommendation to withstand groundwater pressures. For manholes greater than 12-feet in depth, the coating shall withstand the pressures associated with a groundwater depth equal to the manhole depth. Coatings for all other manholes shall withstand the pressures associated with groundwater depth of 12-feet. Measure groundwater depth from manhole bench to top of ground surface.
8. Application of products shall be by factory certified applicators.

3.02 SPRAY APPLIED LIGHT-WEIGHT STRUCTURAL REINFORCED CEMENT

- A. The surface prior to spraying shall be damp without noticeable free water droplets or running water. Materials shall be spray-applied to a minimum uniform thickness to insure that all cracks, crevices, and voids are filled and a somewhat smooth surface remains after light troweling. The light troweling is performed to compact the material into voids and to set the bond.
- B. The first application shall have begun to take an initial set (disappearance of surface sheen, which could be 15-minutes to 1-hour depending upon ambient conditions) before the second application to assure a minimum total finished thickness of 1/2-inch. The final finished thickness may need to be greater than 1/2-inch as recommended by the manufacturer to withstand groundwater pressures. A depth gauge shall be used during application, at various locations, to verify the required thickness. The surface then shall be trowelled to smooth finish with care taken not to over trowel so as to bring additional water to the surface and weaken it. Manufacturer's recommendations shall be followed whenever more than 24-hours have elapsed between applications.
- C. The bench covers used to catch debris shall be removed and the bench and invert sprayed such that a gradual slope is produced from the walls to the invert with the thickness at the edge of the invert being no less than 1/2-inch. The wall-bench intersection shall be rounded to a uniform radius the full circumference of the intersection.
- D. No application shall be made to frozen surfaces or if freezing is expected to occur within the manhole for 24-hours after application. If ambient temperatures are in excess of 95°F, precautions shall be taken to keep the mix temperature at time of application below 90°F, using ice if necessary.
- E. The final application shall have a minimum of 4-hours cure time before being subjected to active flow.

3.03 CENTRIFUGALLY CAST STRUCTURAL REINFORCED CEMENT

- A. Application procedures shall conform to the recommendations of the manufacturer.
- B. The rotating casting applicator shall be positioned to evenly apply the material and be withdrawn at a rate to assure a final minimum thickness of 1-inch. The final finished thickness may need to be greater than 1-inch as recommended by the manufacturer to withstand groundwater pressures. A depth gauge shall be used during application, at various locations to verify the required thickness.
- C. The bench covers used to catch debris shall be removed and the bench and invert sprayed or hand applied so that a gradual slope is produced from the walls to the invert with the thickness at the edge of the invert being no less than 1/2-inch. The wall-bench intersection shall be rounded to a uniform radius the full circumference of the intersection.
- D. No application shall be made to frozen surfaces or if freezing is expected to occur within the manhole for 24-hours after application. If ambient temperatures are in excess of 95°F, precautions shall be taken to keep the mix temperature at time of application below 90°F.
- E. The final application shall have a minimum of 1-hour cure time as recommended by the manufacturer before being subjected to active flow.

3.04 SPRAYED APPLIED EPOXY RESIN SYSTEM

- A. Application procedures shall conform to the recommendations of the manufacturer.
- B. The epoxy resin shall be sprayed onto the surfaces of the manhole walls, benches, and inverts to produce a smooth coating and yield the required structural integrity and corrosion resistance. A depth gauge shall be used during application at various locations to verify the required thickness.
- C. The epoxy resin shall be applied to a minimum thickness of 0.125-inches (125-mils) at the top of the manhole and gradually thickened in accordance with manufacturer's recommendations to withstand groundwater pressures. The application shall have a minimum cure time as recommended by the manufacturer before being subjected to active flow.
- D. The sloped surface of the manhole bench shall be made non-skid by broadcasting aluminum oxide or sand into the surface prior to gelatin/set.

3.05 MULTI-COMPONENT COATING SYSTEM

- A. Application procedures shall conform to the recommendations of the manufacturer.

- B. The coating system shall be sprayed onto the surfaces of the manhole walls, benches, and inverts to produce a smooth surface. The spray equipment shall be specifically designed to accurately ratio and apply the coating system.
- C. Final installation shall be a minimum of 500-mils.
- D. The application shall have a minimum cure time as recommended by the manufacturer before being subjected to active flow.

3.06 SANITARY SEWER LATERAL CONNECTIONS TO MANHOLES

- A. Sanitary sewer lateral connections to rehabilitated manholes shall be reinstated to provide a seamless, leak free, and unobstructed flow connection between the new manhole lining or coating system and the lateral connection per 3.01A.
- B. Sanitary sewer laterals requiring rehabilitation shall be renewed per Section 02772 "Cured-In-Place Pipe (CIPP) For Lateral Renewal."

3.07 MANHOLE REHABILITATION ACCEPTANCE

- A. Test all rehabilitated manholes using the vacuum test method as per ASTM C 1244 "Standard Test Method for Concrete Sewer Manholes by the Negative Air Pressure (Vacuum) Test", following the manufacturer's recommendations for proper and safe procedures. Vacuum testing of manholes and structures shall be performed after curing of coatings. Any visible leakage in the manhole or structure before, during, or after the test shall be repaired regardless of the test results.
- B. All pipes for vacuum testing entering the manhole shall be installed at the top access point of the manhole. A vacuum of 10-inches of mercury (5.0-psi) shall be drawn on the manhole, and the time shall be measured for the vacuum to drop to 9-inches of mercury (4.5-psi). Manholes will be considered to have failed the air test if the time to drop 1-inch of mercury is less than what is shown in the following table:

**Table 02775-2
Vacuum Test Timetable**

Vacuum Test Timetable				
Manhole Diameter – Inches				
Depth – feet	48-inches	60-inches	72-inches	96-inches
4	30 sec.	30 sec.	30 sec.	30 sec.
8	30 sec.	30 sec.	32 sec.	38 sec.
12	30 sec.	39 sec.	48 sec.	57 sec.
16	40 sec.	52 sec.	64 sec.	76 sec.
20	50 sec.	65 sec.	80 sec.	95 sec.
24	60 sec.	78 sec.	96 sec.	114 sec.
+ Each 2'	+5 sec.	+6.5 sec.	+8.0 sec.	+9.5 sec.

- C. Manhole depths shall be rounded to the nearest foot. Intermediate values shall be interpolated. For depths above 24-feet, add the values listed in the last line of the table for each 2-feet of additional depth.
- D. If the manhole or structure fails the vacuum test, the Contractor shall perform additional repairs and repeat the test procedures until satisfactory results are obtained.
- E. After the manhole rehabilitation work has been completed, the manhole shall be inspected by the Contractor in the presence of the County and the work shall be accepted if found satisfactory to the County. No evidence of visible leaks shall be allowed. Non-uniformity, sagging, lamination, holidays or other defects will be cause for rejection of the coating. All surfaces shall be tested for the presence of holidays and pinholes via spark testing at 100-volts per millimeter. The Contractor shall provide the testing equipment and perform the testing in the presence of the County. Any holidays or pinholes found during the testing shall be repaired and the surface re-tested until the surfaces are completely free of holidays and pinholes.

3.08 CLEANUP

- A. After the installation work has been completed and the testing is acceptable, the Contractor shall clean up the entire project area. The Contractor shall dispose of all excess material and debris. The work area shall be left in a condition equal to or better than the prior condition.

3.09 WARRANTY

- A. The Contractor shall guarantee his work for a warranty period of 1-year from the date of acceptance.
- B. If at anytime during the warranty period any leakage, cracking, loss of bond, or other discontinuity is identified, the Contractor shall remove and replace the manhole coating with new material at no cost to the County. No field repair shall be approved.
- C. Furnish an extended warranty for manhole rehabilitation materials from the Contractor and coating manufacturer for a total of 5-years from date of final completion.

END OF SECTION

SECTION 02784
CHAIN LINK FENCES AND GATES

PART 1 - GENERAL

1.01 DESCRIPTION

- A. Scope of Work: This section specifies aluminum coated steel chain link fence, nominally 6-feet high, complete with gates to be constructed around the area indicated on the Drawings.

1.02 QUALITY ASSURANCE

- A. Chain link fences and gates shall be constructed in accordance with specified standards, as well as all pertinent codes and regulations. Where provisions of pertinent codes conflict with the specifications, the more stringent provisions shall govern.
- B. Chain link fences and gates shall be manufactured by established, reputable manufacturers that have been engaged in the manufacture of chain link fencing for at least 10-years.

1.03 SHOP DRAWINGS AND SUBMITTALS

- A. Submittals shall be submitted to the County for review and acceptance prior to construction in accordance with the General Conditions and specifications Section 01300 "Submittals."
- B. The Contractor shall submit layout drawings of all fence and gate installations along with details and manufacturer's literature of all fence and gate materials in the Project.
- C. The Contractor shall submit all motor data, connection diagrams, wiring diagrams, and O&M instructions for all gate operators in the Project.

PART 2 - PRODUCTS

2.01 GENERAL

- A. All material supplied shall be one of the products specified in Appendix D "List of Approved Products" appended to these technical specifications.

2.02 MATERIALS

- A. Fabric: The fabric shall be aluminum coated steel chain link, 72-inches high, No. 9-gauge wire woven in a 2-inch mesh. The fabric shall conform to the requirements of ASTM Designation A491. The aluminum coating shall be a minimum of 0.40-ounces per square foot of wire surface for No. 9-gauge fabric. The fabric shall have a minimum tensile strength of 75,000-psi. The weight of the coating shall be determined by the strip test as defined in ASTM Designation A428. The fabric shall be coated with an ultra violet stable black PVC coating which meets ASTM standards F688 Class I.
- B. Post and Other Appurtenances: All posts and other appurtenances used in the construction of this fence shall be hot dipped galvanized with a minimum of 1.8-ounces per square foot of surface. Pipe sections shall conform to the requirements of ASTM Designation A120. All posts, rails, and fittings shall be coated with an ultra violet stable black PVC coating which meets ASTM standards F688 Class I.
- C. Sizes of Posts, Gate Frames, and Rails:

COMPONENT	DIMENSIONS	
	Nominal Diameter	NPS Pipe Schedule
1. End, corner & pull posts	3-inch	40
2. Gateposts (one leaf width 8-feet or less)	3-inch	40
3. Intermediate posts	2-3/8-inch	40
4. Gate Frames	1-5/8-inch	40
5. Braces	1-5/8-inch	40
6. Top Rails	1-5/8-inch	20

D. Gates

1. Swing Gates: Gates shall be complete with latches, stops, keepers, and hinges. Gate frames shall be constructed of round tubular members continuously welded at all corners or assembled with fittings. Welds shall be painted with aluminum or zinc based paint prior to application of PVC coating. Gate filler shall be of the same fabric as specified for the fence and shall be attached securely to the gate frame with No. 9 tie wires at intervals not exceeding 12-inches. Hinges shall be of adequate strength for the gate and with large bearing surfaces for clamping in position. The hinges shall not twist or turn under the action of the gate. The gates shall be easily operable by one person. Latches, stops, and keepers for all gates, along with 1-inch stainless steel chain and padlock, shall be provided.
2. Sliding Gates: Sliding gates shall be complete with latches, stops, keepers, rollers, and roller tracks. Gate shall ride on a double wheel carrier. Gateposts shall be 3-inch Sch. 40 and frame shall be 1-5/8-inch Sch. 40. Slide pipe tracks shall be 1-5/8-inch Sch. 40. Safety post (outside of gatepost) shall be 3-inch Sch. 40. Fabric shall match fence.

3. Gate padlocks shall be the County standard, case brass, shackle-case hardened steel, 1-inch links with 12-inch chain, 606 finish and keyed alike when more than one.
- E. Top Rail: The top rail shall be provided with couplings approximately every 20-feet. Couplings are to be the outside sleeve type, at least 6-inches long.
- F. Concrete: Concrete shall have a minimum compressive strength of 2,500-psi at 28-days.
- G. Hardware: Miscellaneous hardware shall be of steel, malleable iron or ductile iron of standard design and conform to the requirements of the Chain Link Fence Manufacturer's Institute. All parts shall be galvanized except ties and clips may be aluminum.
- H. Power Gate Operators: The operators for sliding gates shall be Robot Industries, Inc. Model LSG-100, Venco Model SJH, or acceptable equal units designed for use on cantilever sliding gates. Operator motors shall be 1 horsepower and shall be wound for 208 volt, 3 phase, and 60 Hz power supply. Units shall provide gate speed of not less than 75-feet per minute. Units shall be arranged for ground level mounting on 6-inch concrete pads. A quick disconnect for manual operation with a padlock control shall be provided. The cover for the operator shall be of galvanized steel, and the units shall be provided with electric overload protection.

PART 3 - EXECUTION

3.01 ARRANGEMENT

- A. Posts: Posts shall be uniformly spaced, not to exceed 10-feet on centers. Intermediate posts shall have waterproof tops, which have integrally cast openings through which the top rails shall pass. Terminal posts shall consist of end, corner, and pull posts.
- B. Braces: Braces shall be provided at each gate, corner, pull, and end post.
- C. Top Rails: The top rails shall pass through the line post tops and form a continuous brace from end to end of each stretch of fence. The top rail shall be securely fastened to the terminal posts by heavy pressed steel brace bands and malleable end connections.
- D. Bottom Tension Wire: The bottom tension wire shall be No. 7-gauge aluminum coated spring coil or crimped wire. Minimum weight of aluminum coating shall be 0.40-ounces per square foot of wire surface. The tension wire shall be stretched taut between terminal posts and securely fastened to each intermediate post 2-inches above the finish grade line. Tension wire shall be attached to the fence fabric with aluminum hog rings every 24-inches.
- E. Stretcher Bars: Stretcher bars shall be no less than 3/16-inch by 3/4-inch in cross section and shall have minimum length 2-inches longer than the fabric height. Stretcher bars shall be used for attaching the fabric to all terminal posts by threading through the fabric and being attached to the posts with No. 9-gauge tension bands, or other positive mechanical means, spaced at 24-inch centers. One (1) stretcher bar shall be provided for each gate and end post and 2 for each corner and pull post.

- F. Ties and Clips: Fabric shall be fastened to all intermediate posts with 9-gauge tie wires, spacing not to exceed 12-inches apart. Fabric shall be tied to top rail with 9-gauge tie wires, spacing not to exceed 24-inches on centers.

3.02 INSTALLATION

- A. Post Setting: Line and terminal posts shall be set in holes 12-inches in diameter, 42-inches deep with 36-inch post embedment. After the post has been set and plumbed, the hole shall be filled with concrete. The exposed surface of the concrete shall be crowned to shed water.
- B. Terminal and Gateposts: Terminal and gateposts shall be set as specified above and shall be braced to the nearest post with a galvanized horizontal brace used as a compression member and a galvanized 3/8-inch steel truss rod and turnbuckle used as a tension member.
- C. Fabric: Fabric shall not be stretched until concrete footings have cured a minimum of 3-days. Chain link fabric shall be placed on the side designated by the County and shall be stretched taut approximately 2-inches above finish grade and securely fastened to all posts. Rolls of wire fabric shall be joined by weaving a single strand into the ends of the rolls to form a continuous mesh.

END OF SECTION

SECTION 03100
CONCRETE FORMWORK

PART 1 - GENERAL

1.01 DESCRIPTION

- A. Scope of Work: This Section specifies all labor, materials and equipment necessary for providing and installing formwork for concrete.
- B. Related Work Described Elsewhere:
 - 1. Section 03200 "Concrete Reinforcement"
 - 2. Section 03300 "Cast-in-Place Concrete"
- C. General Design: The Contractor shall be responsible for the design of all formwork and for safety in its construction, use and removal.

1.02 QUALITY ASSURANCE

- A. Qualifications: Formwork shall be constructed in accordance with the specified standards, as well as all pertinent codes and regulations. In cases where requirements of pertinent codes conflict with the requirements of these specifications, the more stringent shall govern.
- B. Standards: Unless otherwise indicated, all materials, workmanship and practices shall conform to the following standards:
 - 1. Standard Building Code
 - 2. ACI 347 "Recommended Practice for Concrete Formwork"
 - 3. Local codes and regulations

1.03 SHOP DRAWINGS AND SUBMITTALS

- A. Submittals shall be submitted to the County/Professional for review and acceptance prior to construction in accordance with the General Conditions and specifications Section 01300 "Submittals."
- B. Materials: Submit manufacturer's literature on form ties, spreaders, corner formers, form coatings and bond breakers.

PART 2 - PRODUCTS

2.01 GENERAL

- A. All material supplied shall be one of the products specified in Appendix D "List of Approved Products" appended to these technical specifications.

2.02 MATERIALS

- A. Form Lumber: Use form lumber when in contact with exposed concrete, conforming to the following or acceptable equivalent.
- B. Lumber: Douglas Fir/Larch No. 2 grade, seasoned, surfaced on four sides.
- C. Plywood: "Plyform", Class I or II, bearing the label of the Douglas Plywood Association. (Minimum 3/4-inch thickness).
- D. Form Ties: Use form ties which do not leave an open hole through the concrete and which permit neat and solid patching at every hole. Use embedded rods with integral waterstops and cones to provide a 1-inch breakback. Wire ties and wood spreaders will not be permitted.
- E. Form Coatings: Form release coating shall be a paraffin base oil or mineral oil coating which effectively prevents absorption of moisture; prevents bonding with concrete; is non-staining to concrete; and leaves the concrete with a paintable surface.
- F. Chamfer Strips: Chamfer strips shall be polyvinyl strips or acceptable equal, designed to be nailed in the forms to provide a 3/4-inch chamfer (unless indicated otherwise) at exposed edges of concrete members.

PART 3 - EXECUTION

3.01 INSTALLATION

- A. Construction of Formwork: Forms shall be sufficiently strong to withstand the pressure resulting from the placement and vibration of concrete and shall be sufficiently rigid to maintain specified tolerances. Forms shall be sufficiently tight to prevent loss of mortar, and shall be adequately braced against lateral, upward or downward movement.
- B. Coating of Forms: Apply form coating to board forms prior to placing reinforcing. Keep form coatings off steel reinforcing, items to be embedded, and previously placed concrete.
- C. Form Erection:
 - 1. Provide a means of holding adjacent edges, ends of panels, and ends of sections tightly together and in accurate alignment so as to prevent the formation of ridges, fins, offsets, or similar surface defects of the finished concrete. Insure that forms may be removed without damage to the surface of the finished concrete.
 - 2. Provide a positive means of adjustment of shores and struts. Insure that all settlement is taken up during concrete placing.
 - 3. Temporary openings shall be provided in wall forms to limit the free fall of concrete to a maximum of 6-feet unless an elephant trunk is used. Such openings shall be located to facilitate placing and consolidation and shall be spaced no more than 8-feet apart. Temporary openings shall also be provided in the bottom of the wall, column forms, and elsewhere as necessary to facilitate cleaning and observation immediately prior to placing.

4. Do not embed any form-tying device or part thereof other than metal in concrete.
5. Form surfaces of concrete members except where placement of the concrete is against the ground. The dimensions of concrete members shown on the Drawings apply to formed surfaces, except where otherwise indicated.

D. Form Reuse: Reuse only forms which maintain a uniform surface texture on exposed concrete surfaces. Apply light sanding between uses to obtain such a uniform texture. Plug unused tie rod holes with corks, shave flush, and sand the concrete surface side of the plug.

E. Removal of Forms

1. Forms and shoring for elevated structural slabs, girders, and/or beams shall remain in place until the concrete has reached a compressive strength equal to the specified 28-day compressive strength as determined by test cylinders. Do not remove supports and re-shore. The following table indicates the minimum allowable time after the last concrete is placed before forms, shoring, and/or bracing may be removed.

Structural Item	Minimum Allowable Time
Bottom side of slabs, girders, beams	When concrete reaches specified 28-day compressive strength
Vertical sides of girders, beams	48-hours
Walls not supporting vertical or horizontal loads	48-hours
Walls supporting vertical or horizontal loads	When concrete reaches specified 28-day compressive strength
Footings, pipe encasements, pipe supports	24-hours

2. Do not remove forms from concrete which has been placed with outside air temperature below 50° F without first determining if the concrete has properly set regardless of the minimum times specified in the table above. Do not apply heavy loading on recently poured concrete. Immediately after forms are removed, the surface of the concrete shall be carefully examined and any irregularities in the surface shall be repaired and finished as specified.

F. Formed Openings: Openings shall be of sufficient size to permit final equipment alignment without deflection or offsets of any kind. Where the items pass through the wall, allow space for packing to ensure watertightness. Provide openings with continuous keyways with waterstops where required. Provide a slight flare to facilitate grouting and the escape of entrained air during grouting. Provide reinforcement as indicated and specified. Reinforcing steel shall be at least 2-inches clear from the opening.

G. Embedded Items: Set anchor bolts and other embedded items accurately and hold securely in position in the forms until the concrete is placed and set. Check all special castings, channels, or other metal parts that are to be embedded in the concrete prior to and again after concrete pour. Check all nailing, blocks, plugs, and strips necessary for the attachment of trim, finish, and similar work prior to concrete pour.

H. Pipes and Wall Spools Cast in Concrete

1. Install wall spools, wall flanges, and wall anchors before placing concrete. Do not weld, tie or otherwise connect the wall spools to the reinforcing steel.
2. Support pipe and fabricated fittings to be encased in concrete on concrete piers or pedestals. Carry concrete supports to firm foundations so that no settlement will be possible during Construction.

I. Form Tolerances

1. Failure of the forms to produce the specified concrete surface tolerance shall be grounds for rejection of the concrete work. Rejected Work shall be repaired or replaced at no cost to the County.
2. The following table indicates tolerances or allowable variations from dimensions or positions of structural concrete work:

	Maximum Tolerance
Sleeves and inserts	+1/4-inch to -1/4-inch
Projected ends of anchors	+1/4-inch to -0.0-inch
Anchor bolt setting	+1/4-inch to -1/4-inch
Finished concrete	+ 1/4-inch to -1/4-inch in 10 feet of length

The planes or axes from which the above tolerances are to be measured shall be as follows:

Sleeves and inserts	Centerline of sleeve or insert
Projected ends of anchors	Plane perpendicular to the end of the anchor as located on the Drawings
Anchor bolt setting	Centerline of anchor bolts
Finished concrete	The concrete surface as located on the Drawings

3. Where equipment is to be installed, comply with manufacturer's tolerances if more stringent than above.

END OF SECTION

SECTION 03200
CONCRETE REINFORCEMENT

PART 1 - GENERAL

1.01 DESCRIPTION

- A. Scope of Work: This Section specifies reinforcing steel and welded wire mesh for cast-in-place or precast concrete structures.
- B. Related Work:
 - 1. Section 03100 "Concrete Formwork"
 - 2. Section 03300 "Cast-in-Place Concrete"
 - 3. Section 03410 "Precast Concrete Structures"

1.02 QUALITY ASSURANCE

- A. Standards: Unless otherwise indicated, all materials, workmanship, and practices shall meet all requirements of the current editions of the following standards:
 - 1. Standard Building Code
 - 2. ACI 318 Building Code Requirements for Reinforced Concrete
 - 3. ACI 315 Details and Detailing of Concrete Reinforcement
 - 4. CRSI Manual of Standard Practice, MSP-2

1.03 SHOP DRAWINGS AND SUBMITTALS

- A. Submittals shall be submitted to the County/Professional for review and acceptance prior to construction in accordance with the General Conditions and specifications Section 01300 "Submittals."
- B. Complete shop drawings shall be submitted for comment, including bar lists and placing drawings. Drawings shall show the type, spacing, and location of metal bar supports, the grade of the reinforcing and the name of the manufacturer. The type of coupler splice devices shall be designated.

PART 2 - PRODUCTS

2.01 GENERAL

- A. All material supplied shall be one of the products specified in Appendix D "List of Approved Products" appended to these technical specifications.

2.02 MATERIALS

- A. Reinforcing Bars: ASTM A615, Grade 60, deformed billet steel bars of a USA manufacturer.
- B. Welded Wire Fabric: ASTM A185, galvanized.
- C. Metal Bar Supports: CRSI MSP-2, Chapter 3, Class 2, Type B, Stainless Steel Protected Bar Supports.
- D. Coupler Splice Devices: Cadweld tension couplers capable of developing the ultimate strength of the bar, as manufactured by Erico Products, Incorporated, Solon, Ohio, or equal where acceptable to the County.

2.03 FABRICATION

- A. Fabrication shall meet all requirements of the specified standards. Unless otherwise indicated, the following shall apply:
 - 1. Hooks shall be standard hooks.
 - 2. Bottom bars shall extend a minimum of 6-inches into supporting members.
 - 3. Minimum cover shall be measured to the outermost stirrup, tie or bar.
 - 4. Splices are permitted only where indicated on the Drawings.

PART 3 - EXECUTION

3.01 INSTALLATION

- A. Supporting Reinforcing: Bar supports shall be provided as required by CRSI MSP-2 and AC1315. Top and bottom bars in slabs formed on earth shall be supported on precast concrete block supports except where such bars are properly supported from formwork. Precast concrete block supports are not required in slabs formed on tremie concrete but may be used at the Contractor's option.
- B. Placing Reinforcing: Placing of reinforcing steel and welded wire fabric shall conform to CRSI MSP-2, ACI 315, and the Drawings. Reinforcing shall be securely tied and supported to prevent displacement during concrete placement.
- C. Welded Wire Fabric: Splices in welded wire fabric shall be such that the overlap between outermost cross wires of each fabric sheet is not less than the spacing of the cross wires, plus 2-inches. Fabric shall not be extended through expansion joints or construction joints in slabs on grade except as otherwise indicated on the Drawings.
- D. Coupler Splice: Unless indicated on the Drawings or where conventional lap splices cannot be achieved, full positive tension connections shall be provided. Such devices shall be installed in accordance with the recommendations of the manufacturer.

- E. Dowels: Dowels shall be wired in position prior to placing concrete.
- F. Field Bending: Heat shall not be used to bend bars. Bars shall not be bent after being embedded in concrete.
- G. Welding: Welding of reinforcing will not be permitted.
- H. Place reinforcement a minimum of 2-inches clear of any metal pipe or fittings.

END OF SECTION

THIS PAGE LEFT BLANK INTENTIONALLY

SECTION 03300
CAST-IN-PLACE CONCRETE

PART 1 - GENERAL

1.01 DESCRIPTION

- A. Scope of Work: This Section specifies cast-in-place concrete including all materials, mixing and transport, and performing all labor for the proportioning, mixing, transporting, placing, consolidating, finishing, and curing of concrete.
- B. Related Work Described Elsewhere:
 - 1. Section 03100 "Concrete Formwork"
 - 2. Section 03200 "Concrete Reinforcement"

1.02 QUALITY ASSURANCE

- A. Standards: Unless otherwise indicated, all materials, workmanship and practices shall conform to the requirements of the following standards:
 - 1. Standard Building Code
 - 2. Local Codes and Regulations
 - 3. ACI 318-83, Building Code Requirements for Reinforced Concrete
- B. Plant Qualification: Plant equipment and facilities shall meet all requirements of the checklist for Certification of Ready Mixed Concrete Production Facilities of the National Ready Mixed Concrete Association and ASTM C 94.
- C. Evaluation and Acceptance of Concrete: Evaluation and acceptance of concrete will be in accordance with ACI-318, Chapter 4.

1.03 SHOP DRAWINGS AND SUBMITTALS

- A. Submittals shall be submitted to the County for review and acceptance prior to construction in accordance with the General Conditions and specifications Section 01300 "Submittals."
- B. Materials and Shop Drawings: The following information shall be submitted for review. No concrete shall be furnished until the County has reviewed submittal and no exceptions taken or other favorable response has been returned.
 - 1. Plant Qualification: Satisfactory evidence shall be submitted indicating that the plant and operators have sufficient experience in providing the applicable design mix.

2. Materials: Satisfactory evidence shall be submitted indicating those materials to be used (including cement, aggregates and admixtures) meet the specified requirements.
3. Design Mix: The design mix to be used shall be prepared by qualified persons and submitted for review. Submit affidavit as to design mix performance over the preceding 6-months. The design of the mix is the responsibility of the Contractor subject to the limitations of the Specifications. Acceptance of this submission will be required only as minimum requirements of the Specifications have been met. Such acceptance will in no way alter the responsibility of the Contractor to furnish concrete meeting the requirements of the Specifications relative to strength and slump.
4. Ready Mix Concrete: Provide delivery tickets or weigh master's certificate per ASTM C 94, including weights of cement and each size aggregate, amount of water in the aggregate, and amount of water added at the plant. The amount of water added on the job shall be written on the ticket.

PART 2 - PRODUCTS

2.01 GENERAL

- A. All material supplied shall be one of the products specified in Appendix D "List of Approved Products" appended to these technical specifications.

2.02 MATERIALS

A. Cement

1. Cement for all concrete shall be domestic Portland cement that conforms to the requirements of ASTM Designation C 150 Type I, Type II or Type III. All sanitary sewer manholes, wetwells, pumping stations, tanks and structures exposed to wastewater shall be constructed with Type II cement. Type III cement for high early strength concrete shall be used only for special locations and only with the review and acceptance of the County. Type I cement may be used for buildings and tremie concrete.
2. Only 1 brand of cement shall be used in any individual structure unless acceptable by the County. Cement that has become damaged, partially set, lumpy or caked shall not be used and the entire contents of the sack or container that contains such cement will be rejected. No salvaged or reclaimed cement shall be used.
3. Fly ash shall not be used in either Class A or Class B concrete.

B. Aggregates:

1. ASTM C 33. Coarse aggregates shall be size No. 57. Block cell fill shall be size No. 89.
2. In addition to requirements of ASTM C 33 for structures exposed to wastewater, the following shall apply:
 - a. Soft particles: 2% (2.0 percent)
 - b. Chert as a soft impurity (defined in Table 3 of ASTM C 33): 1% (1.0 percent)
 - c. Total of soft particles and chert as a soft impurity: 2% (2.0 percent)
 - d. Flat and elongated particles (long dimension > 5 times short dimension): 15%.

- C. Water: Clean and free from injurious amounts of deleterious materials.
- D. Air Entraining Admixture: ASTM C 260.
- E. Water Reducing and Retarding Admixture: ASTM C 494, Type D. Admixture shall not contain calcium chloride.
- F. Epoxy Bonding Agent: Sikastix 370, Sikadur Hi Mod, Concrevice 1001-LPL or acceptable equal.
- G. Waterproofing Material: Concrete admixture shall be manufactured and supplied by an approved manufacturer as shown in the Appendix D "List of Approved Products."

2.03 MIXES

A. General Requirements

1. Mix Design: Proportioning shall be on the basis of field experience and/or trial mixtures as specified in ACI 318, Section 4.3. Data on consecutive compression tests and standard deviation shall be submitted. Proportioning for small structures may be by the water/cement ratio under special review and acceptance by the County. Concrete mix design shall comply with the Standard Building Code requirements.
2. Air Content: 5% plus or minus (\pm) 1% (Class A and B).
3. Slump: 4-inches plus or minus (\pm) 1-inch. 8-inches plus or minus (\pm) 1-inch for tremie concrete.
4. Water/cement ratio = 0.45 maximum (all concrete exposed to hydrostatic loading), 0.50 maximum (all other concrete).
5. Minimum Compressive Strength at 28-days
 - a. Class A, 4,000-psi: Water and wastewater structures inclusive of tanks, ditches, pumping stations, tremie concrete and other structures in contact with process water.
 - b. Class B, 3,000-psi: Building structures, curb and gutters, slabs, walks, encasements, thrust blocks, and pipe supports, etc. not in contact with process water.
 - c. Class C, 2,500-psi: Mix wherever specified in the standard drawings such as A103, A112, A303, A406 and A407-2.

B. Production of Concrete

1. General: Concrete shall be ready mixed and shall be batched, mixed and transported in accordance with ASTM C 94, except as otherwise indicated.
2. Air Entraining Admixture: Air entraining admixture shall be charged into the mixture as a solution and shall be measured by means of an acceptable mechanical dispensing device. The liquid shall be considered a part of the mixing water.

3. Waterproofing admixture: New concrete structures shall contain a crystalline waterproofing concrete admixture. Crystalline waterproofing concrete admixture shall be added to the concrete during the batching operation. The admixture concentration shall be added based upon manufacturer design percent concentration of admixture to the required weight of cement. The amount of cement shall remain the same and not be reduced. A colorant shall be added to verify the admixture was added to the concrete for all precast structures. Colorant shall be added and provided at the admixture manufacturing facility, not at the concrete batch plant. It is recommended that the admixture be added first to the rock and sand and blended thoroughly before adding cement and water or per the manufacturer's recommendations. Concrete structures without crystalline waterproofing admixture or admixture without colorant for field verification shall be rejected. Contractor shall provide certification the admixture was installed in accordance with the manufacturer's recommendations.
 4. Water Reducing and Retarding Admixture: Water reducing and retarding admixture shall be added and measured as recommended by the manufacturer. The addition of the admixture shall be completed within 1-minute after addition of water to the cement has been completed, or prior to the beginning of the last 3/4 of the required mixing, whichever occurs first. Admixtures shall be stored, handled and batched in accordance with the recommendations of ACI 68.
- C. Delivery Tickets: In addition to the information required by ASTM C 94, delivery tickets shall indicate the cement content and the water/cement ratio.
- D. Temperatures: The temperature of the concrete upon delivery from the truck shall not exceed 90° F.
- E. Modifications to the Mix: No modifications to the mix shall be made in the plant or on the job which will decrease the cement content or increase the water/cement ratio beyond that specified.

PART 3 - EXECUTION

3.01 PREPARATION

- A. Preparations before Placing: No concrete shall be placed until the review and acceptance of the County has been received. Acceptance will not be granted until forms are clean and reinforcing and all other items required to be set in concrete have been placed and thoroughly secured. The County shall be notified a minimum of 24-hours before concrete is placed.
- B. Conveying:
1. General: Concrete shall be handled from the truck to the place of final deposit as rapidly as practicable by methods which will prevent segregation or loss of ingredients to maintain the quality of the concrete. No concrete shall be placed more than 90-minutes after mixing has begun for that particular batch.

2. Buckets and Hoppers: Buckets and hoppers shall have discharge gates with a clear opening equal to no less than 1/3 of the maximum interior horizontal area, or 5 times the maximum aggregate size being used. Side slopes shall be no less than 60° (degrees). Controls on gates shall permit opening and closing during the discharge cycle.
3. Runways: Extreme care shall be exercised to avoid displacement of reinforcing during the placing of concrete.
4. Elephant Trunks: Hoppers and elephant trunks shall be used to prevent the free fall of concrete of more than 6-feet.
5. Chutes: Chutes shall be metal or metal lined and shall have a slope not exceeding 1 vertical to 2 horizontal and not less than 1 vertical to 3 horizontal. Chutes more than 20-feet long and chutes not meeting the slope requirements may be used only if they discharge into a hopper before distribution.
6. Pumping Equipment: Pumping equipment and procedures shall conform to the recommendations contained in the report of ACI Committee 304 on "Placing Concrete by Pumping Methods," ACI 304.2R-71. The specified slump shall be measured at the point of discharge. The loss of slump in pumping shall not exceed 1-1/2-inches.
7. Conveying equipment Construction: Aluminum or aluminum alloy pipe for tremies or pump lines and chutes, except for short lengths at the truck mixer shall not be permitted.
8. Cleaning: Conveying equipment shall be cleaned at the end of each concrete operation.

3.02 APPLICATION

A. Placing:

1. General: Concrete shall be deposited continuously, or in layers of such thickness (not exceeding 2-feet in depth) that no concrete will be deposited on concrete that has hardened sufficiently to cause the formation of seams or planes of weakness.
2. Supported Elements: At least 2-hours shall elapse after depositing concrete in columns or walls before depositing in beams, girders, or slabs supported thereon.
3. Segregation: Concrete shall be deposited as nearly as practicable in its final position to avoid segregation due to rehandling or flowing. Concrete shall not be subjected to procedures that will cause segregation.
4. Concrete Underwater: All concrete, except that indicated on the Drawings as tremie concrete, shall be placed in the dry.

B. Seals and Tremie Concrete

1. General

- a. Wherever practicable, all foundation excavations shall be dewatered and the concrete deposited in the dry. Where conditions are encountered which render it impracticable to dewater the foundation before placing concrete, a concrete foundation seal shall be placed. The foundation shall then be dewatered, and the balance of the concrete placed in the dry.

- b. When seal concrete is required to be placed, the satisfactory performance of the seal in providing a watertight excavation for placing structural concrete shall be the responsibility of the Contractor. Seal concrete placed by the Contractor, which subsequently fails to perform properly, shall be repaired as necessary to perform its required function, at the expense of the Contractor.
 2. Method of Placing: Concrete deposited underwater shall be carefully placed in the space in which it is to remain by means of a tremie, a closed-bottom dump bucket of not less than 1-cubic yard capacity, or other approved method, and shall not be disturbed after it is deposited. All seal concrete shall be deposited in 1 continuous pour. No concrete shall be placed in running water. All formwork designed to retain concrete underwater shall be watertight, and the design of the formwork and excavation sheeting shall be by a Professional Engineer, registered in the State of Florida.
 3. Use of Tremie: The tremie shall consist of a tube having a minimum inside diameter of 10-inches, and shall be constructed in sections having tight joints. No aluminum parts that have contact with the concrete will be permitted. The discharge end shall be entirely seated at all times, and the tremie tube kept full to the bottom of the hopper. When a batch is dumped into the hopper, the tremie shall be slightly raised (but not out of the concrete at the bottom) until the batch discharges to the bottom of the hopper, after which the flow shall be stopped by lowering the tremie. The means of supporting the tremie shall be such as to permit the free movement of the discharge end over the entire top surface of the Work, and shall permit it being lowered rapidly when necessary to choke off or retard the flow. The flow shall preferably be continuous, and in no case shall be interrupted until the Work is completed. Special care shall be exercised to maintain still water at the point of deposit.
 4. Use of Bottom-dump Bucket: When the concrete is placed by means of a bottom-dump bucket, the bucket shall be lowered gradually and carefully until it rests upon the concrete already placed. The bucket shall then be raised very slowly during the discharge travel; the intent being to maintain, as nearly as possible, still water at the point of discharge and to avoid agitating the mixture. Aluminum buckets will not be permitted.
 5. Time of Beginning Pumping: Pumping to dewater a sealed cofferdam shall not commence until the seal has set sufficiently to withstand the hydrostatic pressure, and in no case earlier than 72-hours after placement of the concrete.
- C. Consolidating Concrete:
1. General: Concrete shall be consolidated by means of internal vibrators operated by competent workmen.
 2. Vibrators: Vibrators shall have a minimum head diameter of at least 2-inches, a minimum centrifugal force of 700-pounds and a minimum frequency of 8,000 vibrations per second.
 3. Vibrators for Confined Areas: In confined areas, the specified vibrators shall be supplemented by others having a minimum head diameter of 1-1/2-inches, a minimum centrifugal force of 300-pounds and a minimum frequency of 9,000 vibrations per second.

4. Spare Vibrator: One (1) spare vibrator for each 3 in use shall be kept on the site during all concrete placing operations.
 5. Use of Vibrators: Vibrators shall be inserted and withdrawn at points approximately 18-inches apart. The duration of each insertion shall be from 5 to 15-seconds. Concrete shall not be transported in the forms by means of vibrators.
- D. Protection: Rainwater shall not be allowed to increase the amount of mixing water, or to damage the surface finish. Concrete shall be protected from construction over-loads. Design loads shall not be applied until the specified strength has been attained.

3.03 CONCRETE FINISHING AND CURING

- A. All slabs exposed to view shall receive a steel trowel finish without local depressions or high points and apply a light hair-broom finish. Do not use stiff bristle brooms or brushes. Leave hair-broom lines parallel to the direction of slab drainage.
- B. All other slabs and footings shall receive a smooth steel trowel finish.
- C. All walls of structures or parts of buildings exposed to view shall receive the following:
 1. Repair defective concrete, remove fins, fill depressions 1/4-inch or deeper, and fill tie holes.
 2. Any surface not receiving a special applied finish, shall receive a slurry finish consisting of 1 part cement and 1-1/2 parts sand by damp loose volume. Dampen surfaces and then apply the slurry with clean burlap pads or sponge rubber floats. Remove any surplus by scraping and then rubbing with clean burlap.
 3. Surfaces that will receive a special applied finish shall be of even color, have no pits, pockets, holes, or sharp changes of surface elevation. Scrubbing with a stiff bristle fiber brush shall produce no dusting or dislodging of cement or sand.
- D. All concrete shall be wet cured a minimum of 7-days; or if not to receive special finishes, coatings or concrete toppings, an acceptable curing compound may be utilized.
- E. All surface defects shall be repaired by removing defective concrete down to sound concrete and repairing with patching mortar. Finished repair shall match adjacent concrete and be cured as specified.

3.04 TESTING

- A. A testing laboratory, acceptable by the County, shall perform required testing. The Contractor shall pay for all tests indicating a failure to comply with the Specifications. The Contractor shall keep the laboratory informed of his schedule.

- B. Standard laboratory compressive test cylinders shall be obtained by the laboratory when concrete is discharged at the point of placing (i.e., discharge end of pumping equipment), and cylinders shall be made and cured in accordance with the requirements of ASTM Designation C 31. A set of 4 cylinders shall be obtained for each 50-cubic yards, or fraction thereof, placed each day for each type of concrete. The cylinders shall be cured under laboratory conditions and shall be tested at 7 and 28-days of age in accordance with the requirements of ASTM Designation C 39.

- C. The testing laboratory shall make slump tests of Class A and Class B concrete as it is discharged from the mixer at the point of placing. Slump tests shall be made for each 25-cubic yards or "pour" of concrete placed. Slump tests may be made on any batch, and failure to meet specified slump requirements shall be sufficient cause for rejection of that batch.

END OF SECTION

SECTION 03410
PRECAST CONCRETE STRUCTURES

PART 1 - GENERAL

1.01 DESCRIPTION

- A. Scope of Work: This Section specifies the materials, labor and equipment required to construct manholes, wetwells, valve vaults, mitered end sections, meter boxes and all other precast concrete structures, as shown on the Drawings and as specified herein.

1.02 QUALITY ASSURANCE

- A. Standards: Unless otherwise indicated, all materials, workmanship and practices shall conform to the following standards.
 - 1. Standard Building Code
 - 2. Local Codes and Regulations
 - 3. ACI Building Code Requirements for Reinforced Concrete
 - 4. American Society for Testing and Materials (ASTM)
 - 5. American Concrete Institute (ACI)
- B. The forms, dimensions, concrete, and construction methods shall be acceptable to the County in advance of construction.

1.03 SHOP DRAWINGS AND SUBMITTALS

- A. Submittals shall be submitted to the County for review and acceptance prior to construction in accordance with the General Conditions and specifications Section 01300 "Submittals."
- B. The Contractor shall submit Shop Drawings to the County, showing all details of construction, reinforcing and joints.
- C. Submit manufacturer's data on certifications and testing for concrete waterproofing additive, joint mastic, gaskets and grout material to be used.

1.04 INSPECTION

- A. The quality of all materials, the process of manufacture, and the finished sections shall be subject to inspection and acceptance by the County. Such inspection may be made at the place of manufacture or at the site after delivery, or at both places, and the sections shall be subject to rejection at any time due to failure to meet any of the specification requirements; even though sample sections may have been acceptable as satisfactory at the place of manufacture. Sections rejected after delivery to the job shall be marked for identification and shall be removed from the job at once. All damaged sections will be rejected. If damaged sections have already been installed; they shall be acceptably repaired if authorized by the County, or removed and replaced at the Contractor's expense.
- B. At the time of inspection, the sections will be carefully examined for compliance with the ASTM designation specified and the acceptable manufacturer's drawings. All sections shall be inspected for general appearance, dimension, "scratch strength", blisters, cracks, roughness, and soundness. The surface shall be dense and close textured.
- C. Imperfections may be repaired subject to the review and acceptance of the County after demonstration by the manufacturer that strong and permanent repairs result. Repairs shall be carefully inspected before final review and acceptance. Cement mortar used for repairs shall have a minimum compressive strength of 4,000-psi at the end of 7-days and 5,000-psi at the end of 28-days, when tested in 3-inch by 6-inch cylinders stored in the standard manner. Epoxy mortar may be utilized for repairs subject to the review and acceptance of the County.

PART 2 - PRODUCTS

2.01 GENERAL

- A. All material supplied shall be one of the products specified in Appendix D "List of Approved Products" appended to these technical specifications.

2.02 PRECAST CONCRETE SECTIONS

- A. Precast concrete wetwell sections, manhole barrel and eccentric top sections shall conform to specifications for precast reinforced concrete manhole sections, ASTM Designation C478, except as otherwise specified below or as shown on the Drawings. Details of precast sections shown on the Drawings, including thickness and reinforcing, shall supersede ASTM C-478 when such details are more stringent than ASTM C-478. The method of construction shall conform to the detailed Drawings appended to these specifications and the following additional requirements:
 - 1. The minimum wall thickness for the various size barrel sections shall be 5-inches, or as indicated in the Drawings.
 - 2. Barrel sections shall have tongue and groove joints. Joints shall be sealed with cold adhesive preformed plastic gaskets set in double rows on the tongue and in the groove prior to setting the next section. Gaskets shall be K.T. Snyder "Ram-Nek", Conseal "CS-102" or acceptable equal. All extension joints shall be sealed with Portland Type II cement after setting of gasket and placement of manhole section into a watertight joint.

3. Type II cement shall be used except as otherwise accepted.
4. New concrete structures shall contain a crystalline waterproofing concrete admix for all new concrete structures including but not limited to manholes, ARV vaults, wetwells, and wetwell top slabs. Crystalline waterproofing concrete admix shall be added to the concrete during the batching operation. Admixture concentration shall be added based upon manufacturer's design percent concentration of admixture to the required weight of cement. The amount of cement shall remain the same and not be reduced. A colorant shall be added to verify the admixture was added to the concrete. Colorant shall be added and provided at the admixture manufacturing facility, not at the concrete batch plant. It is recommended that the admixture be added first to the rock and sand and blended thoroughly before adding cement and water or per the manufacturer's recommendations. Concrete structures without crystalline waterproofing admixture or admixture without colorant for field verification shall be rejected. Contractor shall provide certification from the pre-caster that the admixture was added in accordance with the manufacturer's recommendations. Concrete admixture shall be manufactured and supplied by an approved manufacturer as shown in Appendix D "List of Approved Products."
5. The date of manufacture and the name or trademark of the manufacturer shall be clearly marked on the inside of each precast section. Each section must be inspected and stamped by an accredited testing laboratory.
6. Sections shall be cured by an acceptable method for at least 28-days.
7. Manhole top sections shall be eccentric except that precast concrete slabs shall be used where cover over the top of the pipe is less than 4-feet for all manholes. Lift rings or non-penetrating lift holes shall be provided for handling precast manhole sections. Non-penetrating lift holes shall be filled with non-shrink grout after installation of the manhole sections.
8. Precast concrete slabs over top section, where required, shall be capable of supporting the overburden plus a live load equivalent to ASHTO H 20 loading.
9. The tops of bases shall be suitably shaped to mate with the adjoining precast section.
10. Precast leveling rings for setting cast iron frames over manholes shall be 2-inch thick and have 1 (one) Number 2 continuous reinforcing steel bar.
11. Concrete surfaces shall have form oil, curing compounds, dust, dirt, and other interfering materials removed by brush sand blasting and shall be fully cured prior to delivery.
12. Interior surfaces of manholes, wetwells and valve vaults shall be lined in accordance with Appendix D "List of Approved Products."
13. Manholes to be installed around existing gravity sewers shall consist of a cast-in-place concrete base slab and precast concrete barrel and top sections; lined per Section 3410 – 2.01.11. The base slab shall be as shown on the Drawings and include a joint which is compatible with the bottom barrel section and acceptable to the County. The bottom barrel section shall include an inverted "U-shaped" slot to allow installation of the section over existing pipes. Flow channels shall be provided within the manholes as shown on the Drawings. Annular space between the existing pipe and slot shall be made watertight with non-shrink grout. Existing pipes shall be removed within the manhole and outlets plugged watertight with non-shrink grout as shown on the Drawings.

14. The manholes shall have an invert channel shaped to correspond with the lower half of the pipe. The top of the shelf shall be at the elevation indicated and shall be sloped to drain toward the flowing through channel. Every effort shall be made by the Contractor to construct watertight structures.

PART 3 - EXECUTION

3.01 INSTALLATION

- A. All manholes and other precast structures shall be set in the dry.
- B. Manholes and other precast structures shall be constructed to the dimensions as shown on the Drawings and as specified herein.
- C. The base structure may be cast-in-place concrete as specified in Division 3. The concrete structure shall be placed on the required crushed stone base as shown in the Drawings over a dry sub base of structural fill that has been compacted to 95% (percent) of the maximum dry density as determined by the modified proctor test, ASTM D1557. The tops of the cast in place bases shall be shaped to mate with the precast barrel section and shall be adjusted in grade so that the top of the dome section is at the correct elevation.
- D. Precast bases conforming to all requirements of ASTM C478 and other requirements for precast sections may be used and shall be set on a sub base as described above.
- E. Precast concrete structure sections shall be set vertically with sections in true alignment with a 1/4-inch maximum tolerance per 5-feet of depth. The outside and inside joint shall be filled with a non-shrink mortar and finished flush with the adjoining surfaces. Allow joints to set for 24-hours before backfilling. Backfilling shall be accomplished bringing the fill up evenly on all sides. If leaks appear in the structures, the inside joints shall be caulked with non-shrink grout to the satisfaction of the County. The Contractor shall install the precast sections in a manner that will result in a watertight joint.
- F. Lift rings or non-penetrating lift holes shall be provided for handling pre-cast manhole sections. Non-penetrating lift holes shall be filled with non-shrink grout after installation.
- G. Where holes must be cut in the precast sections to accommodate pipes, cutting shall be done prior to setting them in place to prevent any subsequent jarring which may loosen the mortar joints.
- H. Cast iron frames shall be placed over precast concrete leveling rings, shimmed and set in cement mortar to the required grade. No more than 3 courses of leveling rings shall be used.

END OF SECTION

SECTION 03600

GROUTING

PART 1 - GENERAL

1.01 DESCRIPTION

- A. Scope of Work: This Section specifies the grouting of the annular space between the host pipe and the new liner and the grouting of the space left void in the abandonment of the existing pipelines and structures. The Work consists of furnishing all labor, equipment and materials, and performing all Work connected with the placement of the cementaceous grout to fill the void.

1.02 QUALITY ASSURANCE

- A. Grouting shall be performed by a crew under the direct supervision of a superintendent that has experience in grouting of this nature.
- B. Storage, mixing, handling and placement shall be in accordance with manufacturer's instructions and specifications.

1.03 SHOP DRAWINGS AND SUBMITTALS

- A. Submittals shall be submitted to the County for review and acceptance prior to construction in accordance with the General Conditions and specifications Section 01300 "Submittals."
- B. In addition, the following shall be submitted to the County for review and acceptance prior to construction.
 - 1. A detailed description of equipment and operational procedures to accomplish the grouting operation.
 - 2. Grout mixture design data, grout mixer type, grout samples, and test data.
 - 3. A detailed description of the grouting time schedule.

PART 2 - PRODUCTS

2.01 GENERAL

- A. All material supplied shall be one of the products specified in Appendix D "List of Approved Products" appended to these technical specifications.

2.02 GROUT MATERIAL

- A. The grout shall be a "flowable fill" consisting of a mixture of Type 1 Portland Cement, Type "F" Flyash (ASTM 618), sand and water.

The following is a suggested trial grout mixture for a 1-cubic yard yield:

Cement: 500-pounds
Fly Ash: 500-pounds
Water: 350-pounds (42-gallons)
Sand: 2,248-pounds
Darex (W.R. Grace): 3-ounces (Air Entrainment Additive or equivalent)

The actual grout mixture to be used shall meet the minimum requirements specified below.

- B. The mixture shall contain a minimum of 500-pounds cement and minimum of 400-pounds flyash per cubic yard of grout.
- C. Samples of the grout mixture when set aside in a standard concrete test mold shall show less than 1% of the mixture height of free water on the surface after standing not less than 12-hours.
- D. One (1) set of 3 (three) 3-inch by 6-inch sample test cubes shall be made for each mix preparation. The minimum 28-day strength shall be no less than 1,000-psi. The minimum required slump is 5-inches. The maximum allowable slump is 9-inches. Slump should be as low as practical to maintain viscosity, proper flow, and still retain the ability to pump.

2.03 EQUIPMENT

- A. All grout shall be mixed with a high shear, high-energy colloidal type mixer to achieve the best uniform density.
- B. The grout shall be pumped with a non-pulsating centrifugal or tri-plex pump.
- C. The mixer shall be capable of continuous mixing. Batch mixing shall not be permitted.

PART 3 - EXECUTION

3.01 GROUTING OF ABANDONED PIPE

- A. Where utility pipes are to remain in place (inactive) they shall be filled with a sand/cement grout as specified herein.
- B. The grouting program shall consist of pumping sand-cement grout with suitable chemical additives at pressures necessary to fill the pipe sections in order to prevent the potential for future collapse.

- C. Grouting of pipes shall be in sections not exceeding 300 linear feet.
- D. Grout shall be placed in a maximum of 3 stages, with the initial stage volume equal to or greater than 50% of the total volume for that section of pipe being grouted. The maximum time wait between grouting stages shall be 24-hours.
- E. For each stage, mix and pump the material in one continuous process so as to avoid partial setting of some grout material during that stage; thus, eliminating voids and possible subsequent surface damage due to cave-ins.
- F. Each section shall be grouted by injecting grout from the lowest point and allowing it to flow toward the highest point to displace water from the annulus and assure complete void-free coverage. Grout shall be placed through tubes installed in the bulkheads at the insertion pits or manholes. Grout tubes shall be at least 2-inch nominal diameter.
- G. After the ends of each section of pipe are exposed, the entire space, not to exceed 300 linear feet end to end, shall be sealed by controlled pumping of grout until it flows from the pipe at the opposite end of the grouting. Grouting shall be carried out until the entire space is filled. The ends of these sections shall be capped and/or plugged.
- H. Grout pressure in the void space is not to exceed 5-psi above maximum hydrostatic groundwater level. An open ended, highpoint tap or equivalent vent must be provided and monitored at the bulkhead opposite to the bulkhead through which grout is injected. This bulkhead will be blocked closed as grout escapes to allow the pressuring of the annular space.

3.02 FIELD QUALITY CONTROL

- A. The quality of the grout, application of the equipment, and installation techniques are the responsibility of the Contractor. The review and acceptance or approval of specific mix design, equipment, or installation procedures shall in no way relieve the Contractor of his obligation to provide the final product as specified herein.
- B. The County may stop the grouting operations at any time if the operation does not comply with these Specifications.

END OF SECTION

THIS PAGE LEFT BLANK INTENTIONALLY

SECTION 05500
MISCELLANEOUS METALS

PART 1 - GENERAL

1.01 SCOPE OF WORK

- A. This section specifies the labor, materials, equipment, and incidentals required and installation of covers, grates, frames, hatches, manhole rungs, catch basin castings, and other miscellaneous metals as shown on the Drawings and specified herein.

1.02 QUALITY ASSURANCE

- A. The work in this section shall be coordinated with the work of other Sections. Verify at the site both the dimensions and work of other trades that adjoin items of work in this Section before fabrication and installation of items herein specified.
- B. Furnish to the pertinent trades all items included under this Section that are to be built into the work of other Sections.
- C. Field measurements shall be taken at the site to verify or supplement indicated dimensions and to insure proper fitting of all items.

1.03 SHOP DRAWINGS AND SAMPLES

- A. Submittals shall be submitted to the County for review and acceptance prior to construction in accordance with the General Conditions and specifications Section 01300 "Submittals."
- B. Submit detail drawings showing sizes of members, method of assembly, anchorage, and connection to other members for all products provided under this section to the County for approval before fabrication.
- C. One (1) product sample of each type of product shall be submitted to the County upon request. Samples shall be submitted for concurrent review with Shop Drawings.

1.04 REFERENCE STANDARDS

A. Unless otherwise specified, materials shall conform to the following:

Structural Steel	ASTM A36
Welded and Seamless Steel Pipe	ASTM A53
Gray Iron Castings	ASTM A48, Class 30
Galvanizing, general	ASTM A123
Galvanizing, hardware	ASTM A153
Galvanizing, assemblies	ASTM A386
Aluminum (Extruded Shapes) 6061 T6 (Alum. alloy)	
Aluminum (Extruded Pipe)	6063 T6 (Alum. alloy)
Aluminum Bar Structural	6061 T6 (Alum. alloy)
Bolts and Nuts ASTM, A307	
Stainless Steel Bolts, Fasteners	AISI, Type 316
Stainless Steel Plate and Sheet, Wire	AISI, Type 316
Welding Rods for Steel	AWS Spec. for Arc Welding

PART 2 - PRODUCTS

2.01 GENERAL

A. All material supplied shall be one of the products specified in Appendix D "List of Approved Products" appended to these technical specifications.

2.02 ANCHORS, BOLTS, AND FASTENING DEVICES

- A. Anchors, bolts, and other fastening devices shall be furnished as necessary for installation of the work of this Section.
- B. Compound masonry anchors shall be of the type shown or required and shall be Star Slug compounded masonry anchors manufactured by Star Expansion Industries, by Phillips Drill Co., Rahplug, or acceptable equal. Anchors shall be minimum "2-unit" type.
- C. The bolts used to attach the various members to the anchors shall be the sizes shown or required. Stainless steel shall be attached to concrete or masonry by means of stainless steel machine bolts and iron or steel shall be attached with steel machine bolts unless otherwise specifically noted.
- D. For structural purposes, unless otherwise noted, expansion bolts shall be Wej it "Ankr Tite", Phillips Drill Co. "Wedge Anchors", Hilti "Kwik Bolt", or acceptable equal. When length of bolt is not called for on the Drawings, the length of bolt provided shall be sufficient to place the wedge portion of the bolt a minimum of 1-inch behind the reinforcing steel within the concrete.

- E. Materials for anchor or expansion bolts shall be as noted on the Drawings. If no specific material is listed, hot dipped galvanized steel shall be used. All hardware inside wetwells, manholes, or other wetted areas shall be 316 Stainless Steel.

2.03 ALUMINUM ITEMS

- A. Prefabricated checker plate aluminum hatches shall be Type "JD", or "KD" as manufactured by Bilco Co., equal type by Babcock Davis Associates, Inc.; or acceptable equal, sized as shown. Hatches with any single dimension over 3-feet 6-inches shall be double leaf type. Hatches shall be designed for a live load of 300-pounds per square foot. Hatches shall be watertight.
- B. Check plate aluminum cover plates shall be fabricated to the details shown and installed at the locations shown.
- C. Miscellaneous aluminum shapes and plates shall be fabricated as shown. Angle frames for hatches, beams, grates, etc., shall be furnished complete with welded strap anchors attached. Furnish all miscellaneous aluminum shown but not otherwise detailed. Structural shapes and extruded items shall conform to the detail dimensions or the plans within the tolerances published by the American Aluminum Association.

2.04 STEEL ITEMS

- A. Sleeves shall be steel or cast iron pipe in walls and floors with end joints as shown on the Drawings. All pipe sleeves shall have anchors centered on the circumference as shown.
- B. Miscellaneous steel pipe for sleeves, lifting attachments, and other uses as required shall be Schedule 40 pipe fabricated according to the details as shown on the Drawings.

2.05 CAST IRON ITEMS

- A. Outside pipe clean out frames and covers shall be heavy duty, R 6013 R 6099 series as manufactured by Neenah Foundry Co., or acceptable equal. All outside pipe cleanouts shall be 6-inch diameter.
- B. Trench drain shall be of length shown on the Drawings and shall be heavy duty, cast iron, open grate lid type, Series R 4990 Type A as manufactured by Neenah Foundry Co., or acceptable equal.

- C. Gray iron castings for manhole frames, covers, adjustment rings, and other items shall conform to ASTM A48, Class 30B. Castings shall be true to pattern in form and dimensions and free of pouring faults and other defects which would impair their strength or otherwise make them unfit for the service intended. The seating surfaces between frames and covers shall be machined to fit true. No plugging or filling will be allowed. Lifting or "pick" holes shall be provided, but shall not penetrate the cover. Casting patterns shall conform to those shown or indicated on the Drawings. All manhole frames and covers shall be traffic bearing to meet AASHTO H 20 loadings. Frames shall be suitable for the future addition of a cast iron ring for upward adjustment of top elevation.

PART 3 - EXECUTION

3.01 FABRICATION

- A. All miscellaneous metalwork shall be formed true to detail, with clean, straight, sharply defined profiles and smooth surfaces of uniform color and texture and free from defects impairing strength or durability.
- B. Connections and accessories shall be of sufficient strength to safely withstand stresses and strains to which they will be subjected. Steel accessories and connections to steel or cast iron shall be steel, unless otherwise specified. Threaded connections shall be made so that the threads are concealed by the fitting.
- C. Welded joints shall be rigid and continuously welded or spot-welded as specified or shown. The face of welds shall be dressed flush and smooth. Exposed joints shall be close fitting and jointed where least conspicuous.
- D. Welding of parts shall be in accordance with the Standard Code for Arc and Gas Welding in Building Construction of the AWS and shall only be done where shown, specified, or permitted by the County. All welding shall be done only by welders certified as to their ability to perform welding in accordance with the requirements of the AWS code. Component parts of built up members to be welded shall be adequately supported and clamped or held by other adequate means to hold the parts in proper relation for welding.
- E. Welding of aluminum work shall be on the unexposed side as much as possible in order to prevent pitting or discoloration.
- F. All aluminum finish exposed surfaces, except as specified below, shall have manufacturers' standard mill finish. Aluminum handrails shall be given an anodic oxide treatment in accordance with the Aluminum Association Specification AA C22 A41. A coating of methacrylate lacquer shall be applied to all aluminum before shipment from the factory.

- G. Castings shall be of good quality, strong, tough, even grained, smooth, free from scale, lumps, blisters, sand holes, and defects of any kind which render them unfit for the service for which they are intended. Castings shall be thoroughly cleaned and will be subjected to a hammer inspection in the field by the County. All finished surfaces shown on the Drawings and/or specified shall be machined to a true plane surface and shall be true and seat at all points without rocking. Allowances shall be made in the patterns so that the thickness specified or shown shall not be reduced in obtaining finished surfaces. Castings will not be acceptable if the actual weight is less than 95% (percent) of the theoretical weight computed from the dimensions shown. The Contractor shall provide facilities for weighing castings in the presence of the County showing true weights, certified by the supplier.
- H. All steel finish work shall be thoroughly cleaned of all loose mill scale, rust, and foreign matter before shipment and shall be given 1 shop coat of primer in accordance with Section 09865 "Surface Preparation and Shop Prime Painting." Abrasions in the field shall be touched up with primer immediately after erection. Final painting shall be in accordance with Section 09900 "Painting."
- I. Galvanizing shall be the hot dip zinc process after fabrication. Following all manufacturing operations, all items to be galvanized shall be thoroughly cleaned, pickled, fluxed, and completely immersed in a bath of molten zinc. The resulting coating shall be adherent and shall be the normal coating to be obtained by immersing the items in a bath of molten zinc and allowing them to remain in the batch until their temperature becomes the same as the bath. Coating shall be not less than 2-ounces per square foot of surface.

3.02 INSTALLATION

- A. Install all items furnished except items to be imbedded in concrete or masonry, which shall be installed under Division 3 or Division 4 respectively. Items to be attached to concrete or masonry after such work is completed shall be installed in accordance with the details shown. Fastening to wood plugs in masonry will not be permitted. All dimensions shall be verified at the site before fabrication is started.
- B. All steel surfaces to come in contact with exposed concrete or masonry shall receive a protective coating of an approved heavy bitumastic troweling mastic applied in accordance with the manufacturer's instructions prior to installation.
- C. Where aluminum is embedded in concrete, apply a heavy coat of approved bitumastic troweling mastic in accordance with the manufacturer's instructions prior to installation.
- D. Where aluminum contacts masonry or concrete, provide a 1/32-inch neoprene gasket between the aluminum and the concrete or masonry.
- E. Where aluminum contacts a dissimilar metal, apply a heavy brush coat of zinc chromate primer and provide a 1/32-inch neoprene gasket between the aluminum and the dissimilar metal.

- F. Where aluminum contacts wood, apply 2 coats of aluminum metal and masonry paint to the wood.

END OF SECTION

SECTION 08350
ACCESS HATCH DOORS

PART 1 - GENERAL

1.01 DESCRIPTION

- A. Scope of Work: This Section includes providing all labor, materials and equipment necessary to install the access hatch doors on the wetwell and valve vault as indicated on the Drawings and/or specified herein.

1.02 QUALITY ASSURANCE

- A. Standards: The access doors shall meet the standards of the following:
 - 1. Standard Building Code
 - 2. OSHA Requirements
- B. Manufacturers: Manufacturer shall be selected from one of the specified "Manufacturers" in the Orange County Utilities "List of Materials and Approved Manufacturers" as presented as an Appendix to these technical specifications.

1.03 SHOP DRAWINGS AND SUBMITTALS

- A. Shop Drawings: Shop Drawings shall be submitted to the County for approval. Shop Drawings shall include manufacturer's data sheets showing all materials, connections and other required details to illustrate a complete operating access door. Refer to Division 1, Section 01300 "Submittals" for the specific requirements of the submittal.

1.04 WARRANTY AND GUARANTEES

- A. The manufacturer shall provide lifetime guarantee for the access doors against defects in material and/or workmanship. Refer to Section 01740 "Warranties and Bonds" for requirements.

PART 2 - PRODUCTS

2.01 GENERAL REQUIREMENTS

- A. The access door for the wetwell shall have overall dimensions as shown on the Drawings.

- B. Both the wetwell and the valve vault shall be furnished with an access frame and door(s). Equipment furnished shall include the necessary aluminum access frames, complete with hinged and slide bar equipped doors, stainless steel upper guide holder and level sensor cable holder. Doors shall be of aluminum diamond plate. The wetwell doors shall be sized according to pump manufacturer's recommendations. The access frame and door(s) shall have stainless steel hardware. The valve vault access doors size shall be a minimum of inside to inside wall dimensions with a load rating of 300-pounds per square foot. The support beam for loading rating shall be mounted on the door. Wetwell and valve vault covers shall be permanently embossed "CONFINED SPACE" and painted lettering shall not be acceptable. Each door shall be equipped with a recessed hasp enclosure.
- C. Access hatches over wetwell shall have a non-removable back plate constructed of 1/4-inch floor plate, welded to the frame with holes sized to allow passage of pipe flanges with double modular pipe seal.

PART 3 - EXECUTION

3.01 INSTALLATION

- A. The access hatches and doors shall be installed as recommended by the manufacturer and adjusted for proper operation without binding.
- B. Edges of the aluminum frame that will be in contact with concrete shall be coated with coal tar epoxy prior to casting into the concrete, in accordance with Section 09900 "Painting."

END OF SECTION

SECTION 09901
COATINGS AND LININGS

PART 1 - GENERAL

1.01 SCOPE OF WORK

- A. This specification pertains to the specialty coating and lining of manholes and lift station wet wells and valve vaults. As well as the coating of above ground assets including but not limited to: steel, ductile iron pipe, ductile iron fittings, valves, hydrants, hardware and all appurtenances. Brass, bronze and 316 Stainless Steel shall not be coated.
- B. Precast concrete rehabilitation and new structures: The Work shall include the furnishing and installation of an interior protective lining/coating corrosion protection system including all necessary materials, equipment and tools as required for a complete installation in accordance with the manufacturers recommendations. The completed system shall provide a waterproof, corrosion protection system to prevent any deterioration of concrete surfaces from hydrogen sulfide and other corrosive gases/acids produced by wastewater and to prevent infiltration. To ensure total unit responsibility, all materials and installation thereof shall be furnished by, and coordinated with, 1 supplier/manufacturer.

1.02 QUALITY ASSURANCE

- A. All work shall be proved to be in first class condition and constructed in accordance with the Drawings and specifications. All defects disclosed by tests and inspections shall be remedied immediately by the Contractor at no expense to the County.
- B. Fiberglass liner manufacturers shall certify that the liner has been manufactured, sampled, tested, and inspected in accordance with ASTM D 3753.
- C. Polyethylene liner manufacturers shall certify that the liner has been designed and manufactured in accordance with ASTM F 1759 and these specifications.
- D. Holiday Testing: Each coat shall be holiday tested at the recommended 100-125 volts DC per mil in accordance with the latest edition of the following standards: NACE SP0188-2006, NACE Standard RP0490, ASTM G62

1.03 SHOP DRAWINGS AND SUBMITTALS

- A. Submittals shall be submitted to the County for review and acceptance prior to construction in accordance with the General Conditions and specifications Section 01300 "Submittals."

1.04 COVERAGE

- A. The protective lining/coating corrosion protection shall cover all concrete surfaces within the wetwell or manhole including the adjustment ring area.
- B. Coatings and lining surfaces shall be holiday free and all defects shall be repaired in accordance with the manufacturer's recommendations prior to the next coat being applied.

1.05 REFERENCE STANDARDS

- A. American Society for Testing and Materials (ASTM)
 - 1. ASTM C1244: Standard Test Method for Concrete Sewer Manholes by the Negative Air Pressure (Vacuum) Test Prior to Backfill
 - 2. ASTM D3299: Filament-Wound Glass-Fiber Reinforced Thermoset Resin Corrosion-Resistant Tanks
 - 3. ASTM D3350: Standard Specification for Polyethylene Plastics Pipe and Fittings Materials
 - 4. ASTM D3753: Glass-Fiber-Reinforced Polyester Manholes and Wetwells
 - 5. ASTM D6365: Nondestructive Testing of Geomembrane Seams using the Spark Test.
 - 6. ASTM F1759: Design of High-Density Polyethylene (HDPE) Manholes for Sub-surface Applications
 - 7. ASTM F1869: Measuring Moisture Vapor Emission Rate of Concrete Subfloor Using Anhydrous Calcium Chloride
 - 8. ASTM G62: Standard Test Methods for Holiday Detection in Pipeline Coatings.
- B. NACE INTERNATIONAL (Formerly The National Association of Corrosion Engineers)
 - 1. NACE SP0188-2006 (formerly RP0188): Discontinuity (Holiday) Testing of New Protective Coatings on Conductive Substrates.
 - 2. NACE Standard SP0490-2007 (formerly RP0490): Holiday Detection of Fusion-Bonded Epoxy External Pipeline Coating of 250 to 760 μm (10 to 30-mils).
 - 3. NACE Standard SP0178-2007 (formerly RP0178): Design, Fabrication, and Surface Finish Practices for Tanks and Vessels to Be Lined for Immersion Service

PART 2 - PRODUCTS

2.01 GENERAL

- A. All material supplied shall be one of the products specified in Appendix D "List of Approved Products" appended to these technical specifications.

2.02 HDPE LINERS

- A. The Work shall include the furnishing and installation of an interior protective liner system including all necessary labor, materials, equipment and tools as required for a complete installation. Liner shall be high-density polyethylene (HDPE). This liner shall provide a waterproof, corrosion resistant liner to prevent any deterioration of concrete surfaces from hydrogen sulfide and other corrosive gases/acids produced by wastewater and to prevent infiltration. To ensure total unit responsibility, all materials and installation thereof shall be furnished by, and coordinated with, 1 supplier/manufacturer.
- B. Manhole HDPE Liner shall have a minimum thickness of 2-mm (78-mil) and wetwell HDPE shall have a minimum thickness of 5-mm (195-mil). All HDPE liner sheets shall be extruded with a large number of anchoring studs, a minimum of (420/m², 39/ft²), manufactured during the extrusion process in 1-piece with the sheet so there is no welding and no mechanical finishing work to attach the studs to the sheet. The liner shall have a pull out of 112.5-lbs/anchoring stud. A manufacturer certified fabricator shall custom fit the liner to the formwork in order to protect the concrete surfaces from sewer gases.
- C. All welding shall be performed in accordance with the published directives and procedures of the manufacturer and by welders certified by the manufacturer and documentation shall be provided to the County prior to the Work. Completion of welding will provide a 1-piece monolithic HDPE protective liner system that will provide excellent resistance to hydrogen sulfide attack and will not pull off the wall in the event that infiltration occurs. Flat liner sheet, not anchored, used for overlapping joints, shall have a minimum thickness of 3-mm for manholes or 5-mm for wetwells and shall contain a co-extruded bottom surface layer of conductive polyethylene. Conductive cap strip material shall have a free path from the back side of the sheet to a portion of the concrete surface.
- D. Field welding of the liner at the riser joints shall be completed only after vacuum testing (ASTM C1244) of the new structure has been completed and any concrete joint deficiencies have been rectified. Vacuum testing is not required on rehabilitation of existing structures.
- E. Testing and supervision of the installation and welding shall be performed by qualified staff only and must be checked when completed by visually checking and by Spark Testing all welded joints per ASTM D6365. Holiday testing 20,000 to 35,000 volts. All high voltage discontinuity (spark) testing shall be performed using a Tinker & Rasor model AP/W Holiday Detector or equal.
- F. Penetrations (Forcemain, conduit, etc) shall have an internal boot comprising of minimum of 3/8-inch 316SS band clamp compressing a 2-inch wide neoprene with full circumferential welded boot around each penetration in accordance with the manufacturer's details.

2.03 PREFORMED POLYPROPYLENE (PP) LINERS

- A. The Work shall include the furnishing and installation of an interior protective liner system including all necessary labor, materials, equipment and tools as required for a complete installation. This liner shall provide a waterproof, corrosion resistant liner to prevent any deterioration of concrete surfaces from hydrogen sulfide and other corrosive gases/acids produced by wastewater and to prevent infiltration. To ensure total unit responsibility, all materials and installation thereof shall be furnished by, and coordinated with, 1 supplier/manufacturer.
- B. All joints shall be field welded by hot air extrusion welding with PP welding bead. Field welding of the PP liner at the riser joints shall be completed only after vacuum testing (ASTM C1244) of the new structure has been completed and any concrete joint deficiencies have been rectified. Vacuum testing is not required on rehabilitation of existing structures.
- C. Testing and supervision of the installation and welding shall be performed by qualified staff only and must be checked when completed by visually checking and by Spark Testing all welded joints per ASTM D6365. Holiday testing 20,000 to 35,000 volts. All high voltage discontinuity (spark) testing shall be performed using a Tinker & Rasor model AP/W Holiday Detector or equal.
- D. Penetrations (Forcemain, conduit, etc) shall be gasketed PP pipe bell connectors or PP sleeves for boot type connectors and shall be attached to the PP liner by hot air extrusion welding with PP welding bead in accordance with the manufacturer's details.

2.04 FIBERGLASS LINERS

- A. General: Fiberglass reinforced polyester wetwell and manhole liners shall be manufactured from commercial grade polyester resin or other vinyl ester resin with fiberglass reinforcements. The resin system shall be suitable for atmospheres containing hydrogen sulfide and dilute sulfuric acid, as well as other gases associated with the wastewater collection systems. Fiberglass products shall be manufactured in accordance with National Bureau of Standards, Voluntary Product Standard PS 1569 and ASTM D-3753. All inserts and sleeves for piping shall be in accordance with the liner manufacturer's recommendations and shall result in complete coverage of all pre-cast sections and be capable of passing a spark test. The manufacturer shall have a minimum of 5-years experience in manufacturing products which meet the specified standards and shall provide 3 references to verify the qualifications of the manufacturer.
- B. Materials: Resins shall be a commercial grade unsaturated polyester resin. Reinforcing materials shall be commercial grade "E" type glass in the form of mat, chopped roving, continuous roving, roving fabric or a combination of the above, having a coupling agent that will provide a suitable bond between the glass reinforcement and resin. All materials including resins, glass reinforcement, fillers and additives shall be chemically resistant to hydrogen sulfide gas and the sanitary sewer environment. The combined thickness of the inner surface and the interior layer shall not be less than 0.10-inch. Seams shall be sealed

at the factory with the same glass-resin jointing process.

- C. Fabrication: The exterior surface shall be relatively smooth with no sharp projections and no exposed fibers. The exterior surface shall have a gray Gel-coat coating. The interior surface shall be resin rich with no exposed fibers and shall be free of crazing, delaminations, blisters larger than 1/2-inch diameter, wrinkles of 1/8-inch or greater in depth, resin runs, dry areas, sharp projections, or surface pits greater than 6 per square foot if they are less than 3/4-inch diameter and less than 1/16-inch deep. The exterior surface shall be free of blisters larger than 1/2-inch in diameter. To provide UV protection, the exterior surface shall have a factory applied gray pigment for a minimum thickness of 0.125-inches.
- D. Physical Properties: The fiberglass reinforced wetwell and manhole liner shall be designed for H-20 wheel loading and tested in accordance with ASTM D 3753 8.5 (note 1). The fiberglass reinforced wetwell liner and manholes shall meet the following physical requirements:

	Hoop Direction	Axial Direction
Tensile Strength (psi)	18,000	5,000
Tensile Modulus (psi)	0.6 x 10 ⁶ for MH's 0.8 x 10 ⁶ for Wetwell's	0.7 x 10 ⁶
Flexural Strength (psi)	26,000	4,500
Flexural Modulus (psi)	1.4 x 10 ⁶	0.7 x 10 ⁶
Compressive MH's(psi)	18,000	12,000

- E. Chemical Resistance: When tested in accordance with ASTM D3753 8.7 the log of percent retention of each property after immersion testing when plotted against the log of immersion time and extrapolated to 100,000-hours shall assure retention of at least 50% of the initial properties.
- F. Testing: All tests shall be performed as specified in ASTM D3753 latest edition, Section 8, test method D-790 (note 5) and test method D695. Each completed liner shall be examined for dimensional requirements, hardness and workmanship. All required ASTM D3753 testing shall be completed and records of all testing provided to the County. As a basis of acceptance, the manufacturer shall provide an independent certification which shall consist of a copy of the manufacturer's test report, and be accompanied by a copy of the test results that the liner has been sampled, tested and inspected in accordance with the provisions of this specification and meets all its requirements. The independent certification and manufacturer's test report shall be provided to the County prior to delivery of the Liner.
- G. Fiberglass Reinforced Top: The fiberglass manhole liner top shall be fabricated using fiberglass material as above. Material and installation to meet all physical requirements as above. Top to be attached to wetwell liner pipe with fiberglass layup to comply with ASTM D3299. When reinforcement is necessary for strength, the reinforcement shall be fiberglass channel laminated to the inside of the liner top and shall comply with ASTM D3299. 4,000-psi concrete shall be poured around the entire manhole fiberglass cone section. Lift station top slabs shall be re-poured with HDPE interior liner. Contractor

shall ensure an airtight connect between the Pump Station HDPE lined top slab and interior wetwell liner.

- H. Non-Shrink Grout: Non-shrink grout used in the bench area of manholes and fillet areas of wetwells, or on pipe penetrations shall be 100% calcium aluminate, un-thinned and un-altered, as manufactured by Sewpercoat, Strong-Seal, or an approved equal.
- I. Miscellaneous Materials: Additional items of construction necessary for the complete installation of the fiberglass liner shall conform to specific details on the Drawings and shall be constructed of first-class materials conforming to the applicable portions of these Specifications.

2.05 FERROUS METAL SURFACES (INCLUSIVE OF STEEL AND DIP, HYDRANTS, FITTINGS AND APPURTENANCES)

Cleaning, surface preparation, coating application, and thickness shall be as specified herein and shall meet or exceed the coating manufacturer's recommendations. When the manufacturer's minimum recommendations exceed the specified requirements, Contractor shall comply with the manufacturer's minimum recommendations. All cleaning, surface preparation, coating application, thickness, testing, and coating materials (where available) shall be in accordance with the referenced standards of AWWA, ANSI, NACE, SSPC, NSF, and ASTM. Color-coding shall be Safety Blue, Safety Green and Pantone Purple 522-C for water, wastewater and reclaimed water respectively. Surfaces shall be holiday detected in accordance with ASTM G 62. Areas found to have holidays shall be marked and repaired in accordance with the paint manufacturer's instructions. The County shall be notified of time of testing so that he might be present to witness testing.

- A. Procedures for Coating Exterior of DIP, Hydrants, Fittings and Appurtenances
 - 1. Surface Preparation: Do not abrasive blast or prepare more surface area than can be coated in the same day; prepare surfaces and apply prime coatings within an 8-hour period.
 - a. Steel: Shall require NACE-1/SSPC-SP5 White Metal Blast Cleaning minimum angular anchor profile of 1.5-mils. White metal blast cleaning removes all of the coating, mill scale, rust, oxides, staining, corrosion products, and other foreign matter from the surface.
 - b. DIP: DIP with asphaltic seal coat, Hydrants, FBE (Valves and appurtenances), Shall require NACE-3/SSPC-SP6 Commercial Blast Cleaning minimum angular anchor profile of 1.5-mils. Commercial blast cleaning removes all visible oil, grease, dust, dirt, mill scale, rust, coating, oxides, corrosion products, and other foreign matter from all surfaces and allows stains to remain on 33% (percent) of each unit area of surface.

- c. Note: Primer Option - Hydrants, FBE (Valves and appurtenances), existing factory coatings: Where specifically called out in the Coating System Table below, NACE-4/SSPC-SP7 may be substituted for the commercial blast for hydrants and factory applied FBE (Valves and appurtenances) where the coating manufacturer has specifically provided compatible coatings with existing coatings including urethane, epoxy, alkyd and water-based coatings. Under no circumstances shall DIP with asphaltic seal coat be over-coated. NACE-4/SSPC-SP7 Brush-Off Blast Cleaning shall be free of all visible oil, grease, dirt, dust, loose mill scale, loose rust, and loose coating. Tightly adherent mill scale, rust, and coating may remain on the surface. Mill scale, rust, and coating are considered tightly adherent if they cannot be removed by lifting with a dull putty knife after abrasive blast cleaning has been performed.
2. Contaminants: Remove dirt, dust, oil and all other contaminants that could interfere with adhesion of the coating in accordance with SSPC-SP1 for the substrate and between each coating layer.
3. Temperature: Surface temperature of substrate shall be a minimum of 5°F above the dew point and rising and generally between 40°F to 100°F. Temperatures shall not exceed manufacturer's recommendations.
4. Stripping: Edges, corners, crevices, welds, and bolts shall be given a brush coat/stripe coat for each material/layer. The stripe coat shall be applied by a brush and worked in both directions.
5. Coatings Systems: Two (2) options for coating systems are provided. Each coat shall be a distinctive color or shade to verify each coating in the system.
6. Prime coat: DIP, DIP with asphaltic seal coat, Hydrants, FBE (Valves and appurtenances) prime coat shall be zinc-rich. Zinc-rich shall only be used on bare metal. Factory applied FBE/Asphaltic/Mastic coatings on valves and appurtenances shall be completely removed per NACE 3 / SSPC-SP6.
7. Note: Where specifically called out in the Coating System Table for factory applied FBE (Valves and appurtenances) surface preparation may be NACE-4/SSPC-SP7 and the prime coat shall be an Inorganic water based epoxy. Asphaltic seal coats and mastics shall not be overcoated with Inorganic water based epoxy.
8. Intermediate coat: Varies per coating system.
9. Final Coat: Varies per coating system.
10. Holiday Testing: Each coating layer shall be holiday tested at the recommended 100-125 volts DC per mil in accordance with the latest edition of the following standards: NACE SP0188-2006, NACE Standard RP0490, ASTM G62 and per the manufacturers recommendations. All low voltage holiday testing shall be performed using a Tinker & Razor model M-1 Holiday Detector or equal.
11. Coating Systems: Either System 1 or System 2 shall be used for above ground, non-immersion ferrous metal surfaces (Inclusive of Steel, DIP, Hydrants, Fittings and Appurtenances).

Color Codes

Generic Name	Application	Tnemec	Carboline	PPG / Ameron
Safety Blue	Water Master Meters	True Blue / Safety 11SF	9122	BL Safety Blue
Safety Green	Pump Station Piping	Hunter Green 08SF	V358	GN Safety Green
Pantone Purple 522C	Reclaimed Master Meters	Purple Rain / Safety 14 SF	7528	PL Safety Purple
Safety Green	Hydrant Bonnet & Caps	Hunter Green 08SF	V358	GN Safety Green
Safety Orange	Hydrant Bonnet & Caps	Tangerine Orange / Safety 04 SF	1420	OR 2 Safety Orange
Safety Red	Hydrant Bonnet & Caps	Candy Apple Red / Safety 06SF	7573	RD 2 Safety Red
Safety Silver	Hydrant Barrel	Aluminum 57GR	J766	SL Safety Silver

System 1 - Zinc / Urethane / Fluoropolymer

Description	Generic Coating Name	Tnemec	DFT mils	Carboline	DFT mils
Prime Coat all materials. Surface Prep NACE 1 or NACE 3	Zinc-Rich	Zinc Series 90-97	2.5 - 3.5	Carbozinc 621	3.0 - 8.0
Prime Coat - option for FBE or Hydrants only. Surface Prep NACE 4	Inorganic water based epoxy – overcoat existing coatings	Typoxy Series 27WB	4.0 - 14.0	NA	NA
Intermediate Coat.	Aliphatic Acrylic Polyurethane	Endura-Shield Series 73	2.0 - 3.0	Carbothane 133 HB	3.0 - 5.0
Final Coat.	Advanced Thermoset Fluoropolymer Polyurethane	Hydroflon Series 700	2.0 - 3.0	Carboxane 950	2.0- 3.0

System 2 - Zinc / Epoxy / Urethane

Description	Generic Coating Name	Tnemec	DFT mils	Carboline	DFT mils	PPG / Ameron	DFT mils
Prime Coat all materials. Surface Prep NACE 1 or NACE 3	Aromatic Urethane, Zinc-Rich	Zinc Series 90-97	2.5 - 3.5	Carbozinc 621	3.0 - 8.0	Amercoat 68HS	3
Prime Coat option for FBE, Hydrants. Surface Prep NACE 4	Inorganic water based epoxy – overcoat existing coatings	Typoxy Series 27WB	4.0 - 14.0	NA	NA	NA	NA
Intermediate Coat.	Polyamidoamine Epoxy	Color Hi-Build Epoxoline II Series N69	4.0 - 10.0	Carboguard 60	4.0 - 6.0	Amerlock 2/400	4.0 - 6.0
Final Coat.	Aliphatic Acrylic Polyurethane	Endura-Shield Series 73	2.0 - 3.0	Carboxane 950	2.0 - 3.0	Amercoat 450H	2.0 - 3.0

2.06 SPECIALTY COATINGS

- A. The Specialty Coatings are for rehabilitation of existing precast concrete manholes and existing valve vaults. New precast structures shall be lined only. All specialty coatings applicators shall follow the procedure as outlined below:
1. Pre-Inspection: Applicator shall take appropriate action to comply with all local, state and federal regulations including those set forth by OSHA, EPA, the County and any other applicable authorities. Prior to conducting any work, perform inspection of structure to determine need for protection against hazardous gases or oxygen-depleted atmosphere and the need for flow control or flow diversion.
 2. Bypass plan: Bypass plan for flow control or bypass shall be submitted to the County for approval prior to conducting the work. Any active flows shall be dammed, plugged, or diverted as required to ensure all liquids are maintained below or away from the surfaces to be coated until final applications are cured as recommended by the corrosion protection system manufacturer.
 3. Surface Preparation: NACE 6/SSPC-SP13 "Surface Preparation of Concrete." Dry abrasive blasting, wet abrasive blasting, vacuum-assisted abrasive blasting, and centrifugal shot blasting, high pressure water cleaning (5,000 to 10,000-psig), water jetting (10,000 to 30,000-psig) or combination of methods to remove deteriorated concrete, brick or mortar, laitance, hard contaminants, existing coatings, localized micro-organisms and gas contaminants from the concrete walls, floor, ceiling, and other concrete surfaces and shall display a surface profile suitable for application of the system. Minimum surface profile shall be ICRI CSP-5 or greater. Containment shall be provided to capture spent abrasive material and deteriorated concrete for removal by the Contractor.
 4. Substrate Inspection: After completion of surface preparation, the Contractor shall inspect for: Leaks, Cracks, Holes, Exposed Rebar, Ring and Cover Condition, Invert Condition, Inlet and Outlet Pipe Condition. After the defects in the structure have been identified, repair with a manufacturer approved underlayment or material to assure proper rehabilitation of the surface defect and compatibility with the specialty coating system product to be applied. Repairs to exposed rebar, defective pipe penetrations or inverts, shall be recommended by the specialty coating manufacturer and approved by the County prior to proceeding with the repair. Final preparation and cleaning of repaired surfaces is required prior to application of the coating and shall comply with the corrosion protection system manufacturer's recommendations.
 5. Manufacturer's certification: Applicators, installers, welders and application equipment shall be certified by the manufacturer of the corrosion protection system and documentation shall be provided to the County prior to the work.
 6. Area to be coated: All exposed concrete of the entire interior surface of precast structure including but not limited to benching, pipe penetrations, walls, bottom of top slab, chimney, etc. Flow channel inverts are not necessary to coat. Corrosion protection system shall interface with adjoining construction materials/components throughout the manhole structure to effectively seal and protect substrates from attack by corrosive elements and to ensure the effective elimination of infiltration into the sewer system.

7. Application: Application of specialty coating system shall be in strict accordance with manufacturer's recommendation. Specified surfaces should be shielded to avoid exposure of direct sunlight, other intense heat source or, where cementitious products are employed, excessive ventilation. Where varying surface temperatures do exist, coating installation should be scheduled when the temperature is falling versus rising. Verification of the corrosion protection system thickness shall be verified during application via wet gauge methods or following cure of the system using appropriate non-destructive or destructive methods.
 8. Holiday Testing: Cure time shall be in accordance with the Manufacturers product data sheet. Final concrete structure corrosion protection system shall be completely free of holidays, pinholes or voids. High voltage Holiday testing shall be required and holidays marked and repaired with same material and to same thickness as required of original installation. All high voltage discontinuity (spark) testing shall be performed using a Tinker & Razor model AP/W Holiday Detector or equal and at 100-125 volts DC per mil or per the manufacturers recommendations.
 9. Destructive Testing: Destructive testing may be performed as directed by the County to verify coating adhesion and coating DFT. Repairs to areas tested by destructive means shall be repaired by the certified applicator at the Contractor's expense.
 10. Reporting: Provide final written report to the County detailing the location, date of report, description of repair or original installation and manufacturer data and cut sheets of the corrosion protection system and applicable testing results as per sections 7, 8 and 9.
 11. Warranty: The report shall contain a copy of the warranty.
- B. System SC-1: Sauereisen Sewergard 210 (Trowelable), 210FS (Trowelable Fast Set), 210S (Sprayable) or 210RS (Rotary Spray) shall be applied and then shall be finished with a coat of Sauereisen Sewergard Glaze 210G. The lining system to be utilized shall be an epoxy mortar or aggregate filled epoxy. Material furnished under this specification shall be a pre-packaged from the manufacturer. Materials shall be trowel applied or sprayed and shall conform to the Manufactures product data sheet as supplied by the manufacturer.
1. Additional Preparation: To ensure a good bond, the newly blasted surface shall be thoroughly vacuumed to remove all sand and debris and surface shall be dry prior to application.
 2. Surfacer for Rehabilitation/repair: Substrate in requiring repairs in excess of 1/8-inch shall be repaired with Sauereisen Underlayment No F-120, F-121 or F-209 Filler prior to application of protective lining/coating corrosion protection system.
 3. Thickness:
 - a. Sewergard 210 / 210FS / 210RS: The material shall be applied in 1 or more layers for a total thickness of minimum of 125-mils DFT (1/8-inch). After application, the material shall be damp rolled with excess water shaken off prior to back rolling.
 - b. Sprayable 210S: The material shall be applied in 1 or more layers for a total thickness of minimum of 60-mils shall be required for the Spray applied 210S.
 4. Finishing Glaze: After application, and curing of either the 210, 210FS, 210RS or 210S, the material shall be coated with a minimum of 20-mils of Sauereisen Sewergard Glaze 210G by roller or spray application in accordance with the manufacturers recommendations.

5. Holiday Testing: The protective lining/coating protection system shall be cured in accordance with the manufacturer's recommendations prior to holiday testing at a minimum of 14,500 volts.

C. System SC-2: Tnemec Perma-Shield Coating System.

1. Additional Preparation: To ensure a good bond, the newly blasted surface shall be thoroughly vacuumed to remove all sand and debris and surface shall be dry prior to application and surface shall be minimum 5°F above the dew point. Moisture content not to exceed 3-pounds per 1,000 square feet in a 24-hour period verify dryness using a "plastic film tape-down test" ASTM D4263 and perform Anhydrous Calcium Chloride ASTM F1869.
2. Surfacer for Rehabilitation/repair: Substrate in requiring repairs in excess of 1/8-inch shall be repaired Series 217 or 218 Filler prior to application of protective lining/coating corrosion protection system. Concrete surface shall be pre-wet or dampened with potable water prior to surfacer application.
3. Thickness: Lining Series 434: The material shall be applied in 1 or more layers for a total thickness of minimum of 125-mils DFT (1/8-inch).
4. Finishing Glaze: After application, and curing, the material shall be coated with 15-20-mils of Series 435 in accordance with the manufacturer's recommendations.
5. Holiday Testing: The protective lining/coating protection system shall be cured in accordance with the manufacturer's recommendations prior to holiday testing at a minimum 14,500 volts.

D. System SC-3: Sewercoat (PG and 2000 HS) Calcium aluminate mortar: The coating system to be utilized shall be 100% calcium aluminate cement with 100% calcium aluminate aggregate. Materials shall be spray applied by either a wet gunning (low-pressure spray) or dry gunning (shotcrete) method and shall conform to the manufacturer's product data sheet as supplied by the manufacturer. The equipment shall be clean and free of any hydrated or un-hydrated Portland Cement.

1. Additional Preparation: To ensure a good bond, the newly blasted surface shall be fully saturated with water prior to application.
2. Thickness: The material shall be applied in 1 or more layers to such total thickness as required. A minimum of 1-inch shall be applied.
3. Finishing: After spraying, the material shall be brushed or trowel finished.
4. Curing: Curing by appropriate methods (curing compound, water mist, etc.) should be implemented as the surface begins to harden and dry (as early as 1-hour after application).

E. System SC-4: Raven 405: System shall be 100% solids epoxy. Thinning with solvents shall not be permitted. Surface preparation, mixing, pot life, ambient conditions, application, film thickness per coat, cure time, and recoat time shall be in accordance the manufacturer's recommendations.

1. Applicator/installer shall be certified by the Manufacturer.
2. Surfacer/Repair: Raven 710, 705CA or Raven 700 shall be spray applied or trowelled to repair/fill minor surface defects or applied as an underlayment.

3. Primer: Concrete exhibiting a moisture vapor emission rate greater than 3-lbs/1,000 square feet/24-hours, when tested according to ASTM F1869, shall be primed with Raven 155. Raven 155 primer (2 component waterborne epoxy) shall be applied at a maximum of 8-mil WFT (3-mil DFT). Recoat window minimum 2-4-hours at 72°F with maximum 72-hours at 72°F.
 4. Top Coat: Raven 405 shall be applied with an approved plural component airless spray system. Coating thickness shall be in relation to the profile of the surface to be coated as recommended by the coating product manufacturer. In all cases the coating shall be applied with minimum of 2 coats applied at 40-80-mils WFT/DFT each for minimum final film thickness at 125-mils DFT. Subsequent top coating or additional coats of the coating product(s) shall occur within the product's recoat window: minimum cure to a tacky state; maximum cure of 18-hrs at 72°F substrate temperature. Additional surface preparation procedures will be required if this recoat window is exceeded including inspection for and removal of amine blush and/or other potential contaminants.
 5. Holiday Testing: The protective lining/coating protection system shall be cured in accordance with the manufacturer's recommendations prior to holiday testing at a minimum of 12,500 volts.
- F. SC-5: Spectrashield Multicomponent Coating System. Spectrashield multi-component stress panel liner system composed of moisture barrier (modified polymer), surfaces (polyurethane/polymeric blend foam) and final barrier coat (modified polymer). The system is applied in three-steps and the applicator/installer shall be certified by the Manufacturer.
1. Application
 - a. Moisture barrier: Silicone Modified Polyurea Minimum 40-mils DFT
 - b. Surfacer: Polyurethane/Polymeric blend foam
 - c. Final corrosion barrier: Silicone Modified Polyurea Minimum 60-mils DFT
 2. Film Thickness: Final installation shall be a minimum of 500-mils. A permanent identification and date of work performed shall be affixed to the structure in a readily visible location.
 3. Holiday Testing: The protective lining/coating protection system shall be cured in accordance with the manufacturer's recommendations prior to holiday testing at a minimum of 50,000 volts.

PART 3 - EXECUTION

3.01 QUALITY ASSURANCE

- A. All materials shall be delivered to the job in original sealed and labeled containers of the coating manufacturer, and shall be subject to inspection by the County. Labels shall show name of manufacturer, type of coating, formulation, date, color and manufacturers recommendations. Coatings manufacturer date shall not exceed the manufacturer's recommendations for storage and useful life and Coatings manufactured in excess of 1-year prior to application shall be rejected.

- B. Oil and grease shall be completely removed in accordance with SSPC-SP1 before beginning any other surface preparation method. Surfaces of welds shall be scraped and ground as necessary to remove all slag and weld spatter.
- C. All components of equipment that can be properly prepared and coated after installation shall be installed prior to surface preparation. Components that will be inaccessible after installation shall have the surfaces prepared and coated before installation.
- D. All ferrous metal surfaces shall be free of all defects and have all sharp edges, welds, slag, defects and weld splatter ground smooth in accordance with NACE Standard RPO178.
- E. Edges, corners, crevices, welds, and bolts shall be given a brush coat (stripe coat) for each coating. The stripe coat shall be applied by a brush and worked in both directions. Special attention shall be given to filling all crevices with coating.
- F. Coating shall be applied in a neat manner that will produce an even film of uniform and proper thickness, with finished surfaces free of runs, sags, ridges, laps, and brush marks. Each coat shall be carefully examined and faulty material, poor workmanship, holidays, damaged areas and other imperfections shall be touched up prior to applying succeeding coats. Each coat shall be thoroughly dry and hard before the next coat is applied in accordance with the coating manufacturer's recommendations for drying time between coats. In no case shall coating be applied at a rate of coverage greater than the maximum rate recommended by the coating manufacturer. Each coat shall be uniform in coverage and color. Successive coats shall perceptibly vary in color.
- G. Coating failures will not be accepted and shall be entirely removed down to the substrate and the surface recoated. Failures include but are not limited to holidays, sags, checking, cracking, teardrops, fat edges, fisheyes, or delamination.
- H. Surfaces not required to be coated: Brass, Bronze, Stainless steel (Not including SS bolts and nuts)

3.02 INSPECTION FOR ACCEPTANCE

- A. The quality of materials, the process of manufacture and the finished sections shall be subject to inspection and approval by the County. Such inspection may be made at the place of manufacture, at the site after delivery or at both places and the sections shall be subject to rejection at any time due to failure to meet any of the specification requirements; even though sample sections may have been accepted as satisfactory at the place of manufacture. Sections rejected after delivery to the job shall be marked for identification and shall be removed from the job at once. Sections that have been damaged after delivery will be rejected and if already installed removed and replaced, entirely at the Contractor's expense.

- B. At the time of inspection, the sections will be carefully examined for compliance with the specified ASTM designation and with the approved manufacturer's drawings. Sections shall be inspected for general appearance, dimension, "scratch-strength" blisters, cracks, roughness, soundness, etc. The surface shall be dense and close-textured.
- C. Precast concrete structures shall be inspected by the County and defective materials shall be replaced by the Contractor at the Contractor's expense.
- D. Any repairs made on surfaces shall be holiday detected. Areas found to have holidays shall be marked and repaired in accordance with the coating manufacturer's instructions. The County shall be notified of time of testing so that he might be present to witness testing.

3.03 FIBERGLASS LINER INSTALLATION

- A. Do not drop or impact the fiberglass liner. Use of chains or cables in direct contact with the liner is prohibited.
- B. The Contractor shall sequence the Work so that wastewater service is maintained to existing customers at all times.
- C. The interior of the wetwell shall be pressure washed with an 800 to 1,000-psi water blast, acid washed with a 20% muratic acid solution, and pressure washed a second time. All loose materials, grease/fats, and hydrogen sulfide contamination shall be removed. The existing bench/fillet areas in the wetwell/manhole shall be removed prior to pressure washing. An inspection of the structures shall be conducted by the County prior to the fiberglass liner installation.
- D. Exterior liner diameter shall be approximately 4-inches smaller than the inside diameter of the barrel section of the structure.
- E. Liner depth shall be from invert to top elevation of manhole and wetwell. The top 12-inches of the manhole liner shall be a fiberglass neck that extends from the liner corbel or cone section to the bottom of the ring and cover. The neck is used to protect the concrete grade rings or brick and mortar adjustments from the sewer environment.
- F. The wetwell top slab and manhole corbel or cone section shall be removed and discarded by the Contractor in accordance with all applicable regulations at the Contractor's expense.
- G. Measure and cut wetwell liner to exact length and invert configuration. Measure and cut all incoming and outgoing line openings.
- H. Lower wetwell liner into wetwell and level.
- I. Extend all incoming and outgoing lines inside the liner with PVC or other approved pipe.
- J. The existing concrete bench area of manholes and fillet areas of wetwells shall be removed

completely during initial preparation. Upon installation of the liner, a new bench/fillet shall be constructed with non-shrink grout and shall be field coated with resin and fiberglass in a dry environment after wastewater flows are diverted. The newly constructed bench shall sufficiently overlap the newly installed liner to prevent migration of fluids or gases between the liner and the bench. There shall be no exposed concrete between the factory manufactured fiberglass liner and the field installed fiberglass bench overlay.

- K. Pipe Penetrations: Piping shall extend past the liner into the fiberglass wetwell or flush with the liner. If the existing piping does not fully penetrate the fiberglass liner, the Contractor must extend similar material piping into the fiberglass wetwell. Any gaps on joints must be sealed with a non-shrink grout specified herein.
- L. Pour or pump 3,000-psi pump mix into the annular space between the liner and existing wet well.
- M. Use concrete grade rings on top of the liner cone section to bring ring and cover to finish grade. Manhole liner neck section shall extend from the ring and cover support area up to the ring and cover. The neck section shall be designed to protect the adjustment ring(s), brick and mortar used to bring the ring and cover to final grade
- N. A non-shrinking grout as specified herein shall be applied to areas that cannot be fiberglassed due to water.
- O. Following installation, the Contractor shall determine soundness by applying air or water pressure (3-5-psi) to the wet well or manhole liner. While holding at the established pressure, inspect the entire wetwell and manhole for leaks, based on loss of measured pressure. Any leakage through the laminate is cause for failure of the task. The County shall be present during testing. The Contractor shall be responsible for isolating the work of this Contract from existing work and shall be solely responsible for the method of such isolation. Refer to ASTM D-3753 8.6. Any repairs required shall be repaired in accordance with the manufacturer's recommendations at the Contractor's expense.
- P. Prior to final acceptance and final inspection of the fiberglass liner installation, flush and clean all parts of the system. Remove all accumulated construction debris, rocks, gravel, sand, silt, and other foreign material from the wetwell or manhole

END OF SECTION

THIS PAGE INTENTIONALLY LEFT BLANK

SECTION 09905
PUMP STATION VALVE IDENTIFICATION SYSTEM

PART 1 - GENERAL

1.01 DESCRIPTION

- A. Scope of Work: The work included under this Section consists of providing an identification system for pump station plug and check valves.

1.02 SUBMITTALS

- A. Submit manufacturer's descriptive literature, illustrations, specifications, and other pertinent data in accordance with Section 01300 "Submittals."
- B. Schedules:
1. Provide a typewritten list of all tagged valves giving tag color, shape, letter code and number, the valve size, type, use, and location.
- C. Samples:
1. Provide a sample of each type valve tag supplied.

PART 2 - PRODUCTS

2.01 PUMP STATION VALVE IDENTIFICATION (ABOVE GROUND OR IN VALVE VAULTS)

- A. A coded and numbered tag attached with brass chain and/or brass "S" hooks shall be provided on all valves.
1. Tag Types: Tags for valves on pipe shall be brass or anodized aluminum. Square tags shall be used to indicate normally closed valves and round tags shall indicate normally open valves.
 2. Coding: In addition to the color-coding, each tag shall be stamped or engraved with wording or abbreviations to indicate the valve service and number. All color and letter coding shall be approved by the County. Valve numbering shall be as shown on the Drawings.

PART 3 - EXECUTION (NOT USED)

END OF SECTION

THIS PAGE LEFT BLANK INTENTIONALLY

SECTION 09960
HIGH PERFORMANCE FERROUS METAL COATINGS

PART 1 - GENERAL

1.01 SCOPE OF WORK

- A. The work of this section includes surface preparation, coating systems and methods of application for ferrous metal surfaces. All work shall be done in strict accordance with this specification, the Contract Documents, and the manufacturer's printed instructions.
- B. The Contractor shall furnish all supervision, labor, tools, materials, equipment, maintenance of traffic, containment systems, scaffolding, other structures and incidentals required for transportation, unloading, storage, surface preparation, protection of the public and environment, application of products, and cleanup necessary to complete this Contract in its entirety.
- C. The scope of Work includes painting all exposed miscellaneous metal, pipe, fittings, valves, hangers, straps, support, hardware, equipment, appurtenances, and all other work obviously required to be painted unless otherwise specified. The Contractor shall also paint all surfaces he affects or damages during his performance of the Work, which may be exposed to view in the finished work including, but not limited to, metals, pipe, fittings, valves, equipment and all other existing items similar to proposed items specified for painting. Miscellaneous metal items to be painted shall be included in the Work of this Section where they come within the general intent of the Specifications or as stated herein.
- D. In general the following surfaces shall be painted:
 - 1. Pipe, fittings, flanges, appurtenances and other metal surfaces to 1 ft below grade. Pipe 1 ft below grade and within 6-inches above grade shall be considered immersion surface and shall be coated with the immersion surface high performance coating system.
 - 2. Metal or Galvanized materials including, but not limited to: pipe straps, hangers, pipe support floor stands, nuts, bolts, hardware and tapping saddles. Pipe straps to be removed and coated on both sides.
 - 3. Pipe Surfaces under pipe straps. Pipe straps shall be removed and pipe coated underneath pipe straps regardless if pipe straps are to be coated. No more than two-thirds of the total number of pipe straps shall be removed at any given time.
 - 4. Pedestrian access barriers shall be removed and coated on all sides.
 - 5. Incidentals within the limits of the project including but not limited to bollards, adjacent walkways, walls or supports containing graffiti.
 - 6. Contractor shall provide new 1/2" neoprene that shall be placed at contact interfaces between materials including, but not limited to, pipe support floor stands, pipe straps, and access barriers. The Contractor shall remove and replace existing neoprene where exposed with new material. In situations where 1/2" neoprene is not sized properly for existing conditions, the County on a case by case basis may require a different thickness.

- E. The following surfaces or items are not generally required to be painted, unless noted otherwise. The Contractor shall properly protect these materials from surface preparation, coating application, or damage.
 - 1. Products with polished chrome, aluminum, nickel, Stainless steel, brass, or bronze materials.
 - 2. Stainless steel finish hardware.
 - 3. Flexible couplings.
 - 4. Labels, signs or nameplates including but not limited to: UL, FM, equipment identification, performance rating, name and nomenclature plates.
 - 5. Aluminum handrails, walkways, window, louvers, and grating unless otherwise specified herein.

1.02 REFERENCES

- A. SSPC – Society for Protective Coatings
- B. ASTM – American Society of Testing Materials
- C. NACE – National Association of Corrosion Engineers
- D. NSF – National Sanitation Foundation (Standard 61)
- E. AWWA – American Water Works Association

1.03 DEFINITIONS

- A. Field Coating is the coating of new or rebuilt items at the job site. Field coating shall be the responsibility of the Contractor.
- B. Shop Coating is the coating of new or rebuilt items in the shop prior to delivery to the jobsite.
- C. Exterior – Outside, exposed to weather
- D. Interior – Inside, not subject to immersion service
- E. Immersion service – Material submerged or subject to splash or spray
- F. WFT – Wet Film Thickness
- G. DFT – Dry Film Thickness
- H. MDFT – average minimum dry film thickness
- I. SCARIFY – Roughen the entire existing coating surface by use of brush off blasting, hand tools, sanding, etc to provide an anchor profile for adhesion by new coating systems. Scarified surface shall be approved by the Coatings manufacturer and County prior to over-coating. Existing rust spots, weld slag, sharp edges, defects etc shall be removed by SSPC-SP3 Power tool cleaning.

- J. General: The following referenced surface preparation specifications of the Joint Surface Preparation Standards from NACE International (NACE) and The Society for Protective Coatings (SSPC) shall form a part of this Specification:
1. SSPC-SP1 Solvent Cleaning. Remove all grease, oil, salt, acid, alkali, dirt, dust, wax, fat, foreign matter, and contaminants, etc. by one of the following methods: steam cleaning, alkaline cleaning, or volatile solvent cleaning. Rags and solvents must be replenished frequently to avoid spreading the contaminant rather than removing it. Low-pressure (1500-4000 psi) high volume (3-5 gal/min) water washing with appropriate cleaning chemicals is a recognized "solvent cleaning" method. All surfaces should be cleaned per this Specification prior to using hand tools or blast equipment and between each coating application.
 2. SSPC-SP2 Hand Tool Cleaning. Removal of loose rust, loose mill scale, loose paint and loose foreign matter to a clean sound substrate by hand chipping, scraping, sanding, and wire brushing. Tightly adherent rust, mill scale or paint may remain providing that it cannot be removed by lifting with a dull putty knife
 3. SSPC-SP3 Power Tool Cleaning. Removal of loose rust, loose mill scale, loose paint and loose foreign matter, to a clean sound substrate by power tool chipping, descaling, sanding, abrasive grinding wheels, needle guns, wire brushes, etc. Tightly adherent rust, mill scale or paint may remain providing that it cannot be removed by lifting with a dull putty knife
 4. SSPC-SP5 White Metal Blasting (NACE-1). Complete removal of all visible oil, grease, dust, dirt, mill scale, rust, coating, oxides, corrosion products, and other foreign matter, leaving the surface a uniform gray-white color.
 5. SSPC-SP6 Commercial Blast (NACE-3). Complete removal of all visible oil, grease, dust, dirt, mill scale, rust, coating, oxides, corrosion products, and other foreign matter, leaving only light shadows or discolorations from stains of rust, mill scale, or previous coating on 33% of the unit surface area. At least 66% of each unit surface area is to be free of all visible discoloration or staining.
 6. SSPC-SP 7 Brush-Off Blast (NACE 4). Complete removal of oil, grease, dust, dirt, loose rust, loose mill scale, and loose coatings, leaving tightly adherent mill scale, rust and previous coating. Tightly adherent rust, mill scale or paint may remain providing that it cannot be removed by lifting with a dull putty knife.
 7. SSPC-SP10 Near White Blast (NACE 2). Complete removal of all visible oil, grease, dust, dirt, mill scale, rust, coating, oxides, corrosion products, and other foreign matter, leaving only light shadows or discolorations from stains of rust, mill scale, or previous coating on 5% of the unit surface area. At least 95% of each unit surface area is to be free of all visible discoloration or staining.
 8. SSPC-SP 11 Power Tool Cleaning to Bare Metal. Complete removal of all visible oil, grease, dirt, dust, mill scale, rust, paint, oxide, corrosion products, and other foreign matter and retain or produce a minimum 1.0 mil surface profile. Slight residues of rust and paint may be left in the lower portion of pits if the original surface is pitted.
 9. SSPC-SP 12 Waterjetting (NACE-5). Surfaces preparation by ultra-high pressure water jetting discharged from a nozzle at pressures of 70 MPa (10,000 psig) or greater to prepare a surface for coating or inspection. The difference in degrees of surface cleanliness is defined by the amount of pressure as follows:
 - a. Low Pressure Water Cleaning (LP WC) Less than 34 MPa (5,000 psi)
 - b. High Pressure Water Cleaning (HP WC) 34 to 70 MPa (5,000-10,000 psi)

- c. High Pressure Water Jetting (HP WJ) 70 to 210 MPa (10,000-30,000 psi)
 - d. Ultra-High Pressure Water Jetting(UHP WJ) Above 210 MPa (30,000 psi)
 - e. WJ-1 Clean to Bare Substrate: Complete removal of all visible rust, dirt, previous coatings, mill scale, and foreign matter. Discoloration of the surface may be present.
 - f. WJ-2 Very Thorough or Substantial Cleaning: Complete removal of all visible oil, grease, dirt, and rust except for randomly dispersed stains of rust, tightly adherent thin coatings, and other tightly adherent foreign matter limited to a maximum of 5% of the surface.
 - g. WJ-3 Thorough Cleaning: A WJ-3 surface shall be cleaned to a matte (dull, mottled) finish is free of all visible oil, grease, dirt, and rust except for randomly dispersed stains of rust, tightly adherent thin coatings, and other tightly adherent foreign matter limited to a maximum of 33% of the surface.
 - h. WJ-4 Light Cleaning: A WJ-4 surface shall be cleaned to a finish which is free of all visible oil, grease, dirt, dust, loose mill scale, loose rust, and loose coating. Any residual material shall be tightly adherent.
10. SSPC-SP13 Surface Preparation of Concrete (NACE-6). Complete removal of contaminants, laitance, form oils, dust, dirt, loosely adhering concrete, and previous coating. Blasting, High-pressure water cleaning or waterjetting methods should be performed sufficiently close to the surface so as to open up surface voids, bug holes, air pockets, and other subsurface irregularities, but so as not to expose underlying aggregate.
11. SSPC-SP 14 Industrial Blast Cleaning (NACE-8). Complete removal of oil, grease, dust, dirt, loose rust, loose mill scale, and loose coatings, leaving tightly adherent mill scale, rust and previous coating evenly distributed on 10% of the unit surface area. Stains and discolorations may be present on 90% of the unit area. Tightly adherent rust, mill scale or paint cannot be removed by lifting with a dull putty knife.
12. SSPC-SP 15 Commercial Grade Power Tool Cleaning. Complete removal of all visible oil, grease, dirt, rust, coating, oxides, mill scale, corrosion products, and other foreign matter, except random staining shall be limited to no more than 33 percent of each unit area of surface. Staining may consist of light shadows, slight streaks, or minor discolorations caused by stains of rust, stains of mill scale, or stains of previously applied coating. Slight residues of rust and paint may also be left in the bottoms of pits if the original surface is pitted. (Equivalent standard as SSPC-SP6 Commercial Grade Blast Cleaning NACE-3).

1.04 SUBMITTALS

- A. Submit to the Engineer as provided in the General Conditions and Division 1, shop drawings, manufacturer's specifications and data on the proposed paint systems and detailed surface preparation, application procedures and dry film thickness.

- B. Schedule of Painting Operations: The Contractor shall submit for approval a complete Schedule of Painting Operations within 30 days after the Notice to Proceed. It shall be the Contractor's responsibility to properly notify and coordinate with the County for schedule updates and site activities. This Schedule shall include for each surface to be painted, the brand name, the volume of solids, the coverage and the number of coats the Contractor proposes to use in order to achieve the specified dry film thickness. When the schedule has been approved, the Contractor shall apply all material in strict accordance with the approved Schedule and the manufacturer's instructions. Wet and dry paint film gauges shall be utilized by the County to verify the proper application while Work is in progress.
- C. Protection and Containment Plan: The Contractor shall submit for approval the process, equipment, design, materials, requirements, disposal and methods to provide for protection of the environment, collection of abrasive blasting material, collection of existing coatings, protection of the public and protection for public access.
- D. Maintenance of Traffic Plan (MOT): The Contractor shall prepare and submit a Traffic Control Plan to the Owner, and Orange County Public Works Department or Florida Department of Transportation for review and acceptance prior to commencing any Work on the site. The Traffic Control Plan shall detail procedures and protective measures proposed by the Contractor to provide protection and control of traffic affected by the Work consistent with the following applicable standards:
1. Standard Specifications for Road and Bridge Construction, Latest Edition including all subsequent supplements issued by the Florida Department of Transportation (FDOT Spec.).
 2. Manual of Traffic Control and Safe Practices for Street and Highway construction, Maintenance and Utility Operations, FDOT.
 3. Right-of-Way Utilization Regulations, Orange County, Florida, latest edition.
- E. Test panels/samples: At the request of the County, samples of the finished work prepared in strict accordance with these Specifications shall be furnished, and all painting shall be equal in quality to the approved samples. Finished areas shall be adequate for the purpose of determining the quality of workmanship. Experimentation with color tints shall be furnished to the satisfaction of the County where standard chart colors are not satisfactory.
- F. Equivalent materials of other manufacturers may be substituted on approval of the Engineer. Substitutions that decrease the film thickness, the number of coats applied, change the generic type of coating, or fail to meet the performance criteria of the specified materials will not be approved. Prime and finish coats of all surfaces shall be furnished by the same manufacturer. Requests for substitution shall include Manufacturer's literature for each product giving the name, generic type, descriptive information, evidence of satisfactory past performance, and an independent laboratory certification that their product meets the performance criteria of the specified materials including but not limited to the following:
1. Abrasion – Fed. Test Method Std. No. 141, Method 6192, CS-17 Wheel, 1,000 grams load
 2. Adhesion – Elcometer Adhesion Tester
 3. Exterior Exposure – Exposed at 45 degrees facing the ocean (South Florida Marine Exposure)
 4. Hardness – ASTM D3363-74

5. Humidity – ASTM D2247-68
6. Salt Spray (Fog) – ASTM B117-73

1.05 QUALITY ASSURANCE

A. Manufacturer's Qualifications

1. All paints and/or coatings applied in the performance of the Work shall be supplied by one paint supplier and be the product of one manufacturer; unless the County specifies or accepts a specialty paint not available from that manufacturer.
2. The paint manufacturer shall have supplied paint for water and wastewater facilities for a minimum of ten (10) years, and products supplied shall be contained within the manufacturer's standard water and wastewater brochure.
3. When the manufacturer's minimum recommendations exceed the specified requirements, Contractor shall comply with the manufacturer's minimum recommendations.

B. Contractor / Applicator Qualifications as listed below shall be submitted at the time of Bidding as part of the Bid Package.

1. The Contractor's Project Superintendent / Project Manager shall be at minimum certified NACE Level 1 and be in good standing with NACE International prior to bidding. The Contractor have a Competent Person onsite as defined by OSHA. Certification credentials shall be provided to the County and verifiable through the NACE.org certification search website.
2. The Contractor must show proof that all employees associated with this project shall have been employed by the Contractor for a period not less than six (6) months.
3. Painting shall be performed by experienced painters in accordance with the recommendations of the paint manufacturer and the Contract Documents. All paint shall be uniformly applied without sags, runs, spots, or other blemishes. Work that shows carelessness, lack of skill, or is defective in the opinion of the County, shall be corrected at the expense of the Contractor.
4. The applicator shall have practical experience and successful history in the application of the specified products to surfaces of water supply and wastewater collection and treatment facilities. A written list of references shall be provided to show experience and costs with high performance coatings on pipelines and aerial crossings as well with all other aspects with the defined Scope of Work.
5. The Contractor shall provide a list of equipment owned and maintained by the Contractor that shall be utilized on the project.
6. The Contractor shall provide their written QA / QC program.
7. Contractors shall submit their protection and containment plan to prevent blasting debris, paint chips, paint overspray from entering water bodies.

C. Safety and Health Requirements.

1. General: In accordance with the requirements of the OSHA Regulations for Construction, the Contractor shall provide and require the use of personal protective and lifesaving equipment for all persons working in or about the Project including, but not limited to, head and face protection, fall protection, safety harnesses and respiratory devices. Applicable health and safety precautions required by appropriate regulatory agencies such as OSHA, ANSI, etc., shall be followed.

2. Ventilation: Ventilation shall be adequate to reduce the concentration of air contaminants to the degree that a hazard to workers does not exist.
3. Sound Levels: Whenever the occupational noise exposure exceeds the maximum allowable sound levels, the Contractor shall provide and require the use of approved ear protective devices.
4. Illumination: Adequate illumination shall be provided while work is in progress. Whenever required by the County, the Contractor shall provide additional illumination and necessary support sufficient to cover all areas to be checked. The level of illumination required for observation purposes shall be determined by the County.
5. Temporary Ladders and Scaffolding: All temporary ladders and scaffolding shall conform to the applicable requirements of the OSHA Regulations for Construction. The Contractor shall provide access to the County for all areas of work during each phase of construction.
6. Safety of Public. Provide scaffolding, signage, temporary pedestrian access and barricades as required to protect the public from the work area. Areas to be closed off shall require public notice.

D. Pre-Job Conference

1. A pre-job meeting shall be held prior to the commencement of the Work, prior to significant phases or per specific site location if the Work is not contiguous. Attendance shall include the County, Engineer, Contractor, and Painters Site Supervisor. The meeting will address site specific issues including but not limited to: schedule, access to the site, safety requirements, surface preparation, application, coating systems, inspection, quality control, MOT, protection of the public and protection of the environment as covered in the specifications.
2. Copies of all manufacturer's instructions and recommendations shall be furnished to the County and Engineer by the Contractor prior to the meeting.
3. It shall be the responsibility of the Coating Manufacturer to have their factory representative meet in person with the Contractor and Engineer a minimum of three times during the job as a consultant on surface preparation, mil thickness of coating and proper application of coating unless meeting is determined to be unnecessary by the Engineer.

E. Surface Preparation

1. Visual Standard SSPC-VIS-1 (Swedish SIS OS 5900), "Pictorial Surface Preparation Standards for Painting Steel Surfaces" and The National Association of Corrosion Engineers, "Blasting Cleaning Visual Standards" (TM-01-70 and TM-01-75) shall be the standards used to evaluate proper surface preparation.
2. To facilitate inspection, the Contractor shall on the first day of blasting operations, blast metal panels (12" x 12" x 1/4") to the degree called for in the Specifications and as noted above. Once a sample panel has been approved, it shall establish the quality of all subsequent Work by reference. The sample shall then be stored in a dry, sealed plastic container on the job site. Sample panels shall be prepared and approved for each type of sandblasting specified and shall be maintained and utilized by the County throughout the duration of sandblasting operations as reference standards of quality. Coatings shall be applied only at temperatures and conditions recommended by the paint manufacturer.

F. Inspection Devices:

1. The Contractor shall utilize, until final acceptance of the Work, inspection devices in good working condition for the detection of holidays, environmental conditions, and measurements of wet and dry-film thicknesses of protective coatings. Inspection devices shall be operated in strict accordance with the manufacturer's printed instructions and applicable SSPC and NACE standards and guidelines.
2. Thickness and Holiday Checking: Thickness of coatings shall be checked with a nondestructive, magnetic type thickness gauge. Coating integrity of coated surfaces shall be tested with an approved holiday detection unit per the paint manufacturer's recommendation. All pinholes shall be marked, repaired in accordance with the paint manufacturer's printed recommendations and re-tested. No pinholes or other irregularities will be permitted in the final coating. In cases of dispute concerning film thickness or holidays, the Contractor shall abide by the County's determination unless independent tests are performed by a certified lab at the Contractor's expense. Field measurements of film thickness shall not exceed the requirements of SSPC-PA 2 Measurement of Dry Coating Thickness with Magnetic Gages. Discrepancies shall be measured and verified with a micrometer or Tooke gauge if no other option is available.

1.06 PRODUCT DELIVERY STORAGE AND HANDLING

- A. Delivery: All materials shall be delivered to the job in undamaged, original packages with seals unbroken and in legible, labeled containers. Packages shall not be opened until the County inspects them and they are required for use. Labels shall show name of manufacturer, type of coating, formulation, date, color and manufacturers' recommendations and instructions for use.
- B. Storage: All painting materials shall be stored in a clean, dry, well-ventilated place, protected from sparks, flame, and direct rays of the sun or from excessive heat. Paint susceptible to damage from low temperatures shall be kept in a heated storage space when necessary. The Contractor shall be solely responsible for the protection of the materials he stores at the job site. Empty coating cans shall be neatly stacked in areas the Owner designates, and shall be removed from the job site on a schedule the Owner determines.
- C. Mixing: Mechanical mixers, capable of thoroughly mixing the pigment and vehicle together, shall mix the paint prior to use where required by manufacturer's instructions, however, thorough hand mixing will be allowed for small amounts up to one gallon. Pressure pots shall be equipped with mechanical mixers to keep the pigment in suspension, when required by manufacturer's instructions. Otherwise, intermittent hand mixing shall be done to assure that no separation occurs. Materials shall be in full compliance with the requirements of pertinent codes and fire regulations.
- D. Thinning: Catalysts or thinners shall only be utilized as recommended by the manufacturer, and shall be added or discarded strictly in accordance with the manufacturer's instruction.

1.07 PROJECT SITE CONDITIONS

- A. Application: Paint shall be applied only on thoroughly dry surfaces and during periods of favorable weather, unless specifically allowed by the paint manufacturer. Except as provided below, painting shall not be permitted when the atmospheric temperature is below 50° F, or when freshly painted surfaces may be damaged by rain, fog, dust, or condensation, and/or when it can be anticipated that these conditions will prevail during the drying period.
- B. No coatings shall be applied unless the relative humidity is below 85%.
- C. No coatings shall be applied unless surface temperature is a minimum of 5° above dew point; temperature must be maintained during curing.

1.08 WARRANTY

- A. Warranty Inspection: Warranty inspection shall be conducted during the eleventh month of the one (1) year warranty period following completion of all painting Work. All defective Work shall be repaired in strict accordance with this Specification, and to the satisfaction of the paint manufacturer and the County.
- B. Fluoropolymer / Fluorourethane. The Contractor shall warrant through the Manufacturer that the coating system shall not: check, crack, blister or delaminate from the substrate; change color more than 12 MacAdam units as determined in accordance with ASTM D2244; exhibit loss of gloss in excess of 24 units as measured by a gloss meter in accordance with ASTM D523-8; or chalk in excess of a rating of 8 as measured in accordance with ASTM D4214, Method A. Warranty coverage shall be effective for a period of 15 years from Final Completion depending on color. The Contractor shall notify the Manufacturer prior to ordering materials and begin the warranty process. Sample panels shall be obtained from the Manufacturer, and at least 2 sample panels shall be provided to the County in addition to the Manufacturers minimum requirements regarding the warranty process. The Contractor shall not be permitted to install the coating system until the Manufacturer has provided assurance that the color, substrate, surface preparation or existing conditions are in conformance with the Manufacturer's requirements for warranty.

PART 2 - PRODUCTS

2.01 GENERAL

- A. The painting schedule has been prepared on the basis of Tnemec and Carboline products, and their recommendations for application.
- B. No paint containing lead shall be allowed.

2.02 COATING SYSTEMS

- A. The following summarizes the painting systems for various types of applications.

- B. The Contractor shall have the coating color matched or tinted by the coating supplier to exactly match Tnemec Color Codes as shown below. Manufacturers other than Tnemec shall submit a color matched swatch to the County for approval prior to ordering materials.

Color Table

Fluid Conveyed by Pipe	Tnemec Color Codes
Potable Water (WM)	True Blue 11SF
Wastewater (FM)	Hunter Green 08SF
Reclaimed Water (RWM)	Purple Rain 14SF

- C. Minimum film thickness shall be per manufacturer's recommendations unless a greater thickness is specified. The Contractor shall measure minimum film thickness in the field by utilizing a wet film gauge, which the County shall verify. Regardless of anchor profile, the Contractor shall utilize a wet film gauge to verify that the County-specified average minimum dry film thickness (MDFT) is being applied. The calculated value for wet film thickness (WFT) shall be derived from County's average MDFT unless the manufacturer's minimum range is greater. Following the manufacturer's recommended drying time, the Contractor shall measure and provide results to the County verifying that the average minimum dry film thickness meets the MDFT for each coat and final system, utilizing a dry film gauge. The County may conduct side-by-side verification.
- D. Coating systems shall incorporate the paints specified below, applied at the average dry film thickness (DFT) in mils per coat noted, and have the specified minimum average dry film thickness (MDFT) for each individual coat and total system.

HP – High Performance Coatings of FERROUS METALS

System HP-1
 EXTERIOR EXPOSURE, UV EXPOSURE (NON-IMMERSION)
 Complete removal of existing coating system

Coat	Tnemec	Carboline
Prime	Zinc Series 90-97 2.5 to 3.5 DFT Avg 3.0 MDFT	Carbozinc 621 3.0 to 8.0 DFT Avg 3.5 MDFT
Intermediate	Endura-Shield Series 73 2.0 to 3.0 DFT Avg 2.5 MDFT	Carbothane 133 HB 3.0 to 5.0 DFT Avg 3.5 MDFT
Finish	Hydroflon Series 700 2.0 to 3.0 DFT Avg 2.5 MDFT	Carboxane 950 2.0 to 3.0 DFT Avg 2.5 MDFT
Total	8 MDFT	9.5 MDFT

System HP-2
 EXTERIOR EXPOSURE, UV EXPOSURE (NON-IMMERSION)
 Over-coating of localized inaccessible existing coatings and galvanized metal

Coat	Tnemec	Carboline
Prime	Chembuild 135 4.0 to 9.0 DFT Avg 5.0 MDFT	Carboguard 553 3.0 to 4.0 DFT Avg 3.5 MDFT
Intermediate	Endura-Shield Series 73 2.0 to 3.0 DFT Avg 2.5 MDFT	Carbothane 133 HB 3.0 to 5.0 DFT Avg 3.5 MDFT
Finish	Hydroflon Series 700 2.0 to 3.0 DFT Avg 2.5 MDFT	Carboxane 950 2.0 to 3.0 DFT Avg 2.5 MDFT
Total	9.5 MDFT	9.5 MDFT

System HP-3
 EXTERIOR EXPOSURE, UV EXPOSURE (NON-IMMERSION)
 Over-coating of existing solvent based coating system exposed to UV

Coat	Tnemec	Carboline
Existing	Existing coating system	Existing coating system
Spot Prime	Chembuild 135 4.0 to 9.0 DFT Avg 5.0 MDFT	Carboguard 553 3.0 to 4.0 DFT Avg 3.5 MDFT
Intermediate	Chembuild 135 4.0 to 9.0 DFT Avg 5.0 MDFT	Carboguard 553 3.0 to 4.0 DFT Avg 3.5 MDFT
Finish	Hydroflon Series 700 2.0 to 3.0 DFT Avg 2.5 MDFT	Carboxane 950 2.0 to 3.0 DFT Avg 2.5 MDFT
Total	7.5 MDFT	6.0 MDFT

System HP-4
 INTERIOR/EXTERIOR EXPOSURE, NON-UV EXPOSURE (NON-IMMERSION)
 Over-coating of existing coating, or manufacturer epoxy-primed surface not exposed to UV

Coat	Tnemec	Carboline
Existing	Existing coating system	Existing coating system
Spot Prime	Chembuild 135 4.0 to 9.0 DFT Avg 5.0 MDFT	Carboguard 553 3.0 to 4.0 DFT Avg 3.5 MDFT
Intermediate	Chembuild 135 4.0 to 9.0 DFT Avg 5.0 MDFT	Carboguard 553 3.0 to 4.0 DFT Avg 3.5 MDFT
Finish	Hi-Build Epoxoline II Series N69 4.0 to 8.0 DFT Avg 4.5 MDFT	Carboguard 60 4.0 to 6.0 DFT Avg 4.5 MDFT
Total	9.5 MDFT	8.0 MDFT

System HP-5
 EXTERIOR EXPOSURE, (IMMERSION)
 Complete removal of existing coating system for immersion surfaces

Coat	Tnemec	Carboline
Prime	Zinc Series 90-97 2.5 to 3.5 DFT Avg 3.0 MDFT	Carbozinc 621 3.0 to 8.0 DFT Avg 3.5 MDFT
Intermediate	Hi-Build Epoxoline II Series N69 4.0 to 8.0 DFT Avg 4.5 MDFT	Carboguard 60 4.0 to 6.0 DFT Avg 4.5 MDFT
Finish	Hi-Build Epoxoline II Series N69 4.0 to 8.0 DFT Avg 4.5 MDFT	Carboguard 60 4.0 to 6.0 DFT Avg 4.5 MDFT
Total	12.0 MDFT	12.5 MDFT

System HP-6
 INTERIOR/EXTERIOR EXPOSURE, UV EXPOSURE (NON-IMMERSION)
 Over-coating of existing water based or unknown coating surface exposed to UV

Coat	Tnemec	Carboline
Existing	Existing coating system	Existing coating system
Spot Prime	Typoxy Series 27WB 4.0 to 14.0 DFT Avg 4.5 MDFT	NA
Intermediate	Typoxy Series 27WB 4.0 to 14.0 DFT Avg 4.5 MDFT	NA
Finish	Hydroflon Series 700 2.0 to 3.0 DFT Avg 2.5 MDFT	NA
Total	7.0 MDFT	NA

System HP-7
 EXTERIOR EXPOSURE, UV EXPOSURE (NON-IMMERSION)
 Over-coating of localized inaccessible existing coatings

Coat	Tnemec	Carboline
Prime	Chembuild 135 4.0 to 9.0 DFT Avg 5.0 MDFT	Carboguard 553 3.0 to 4.0 DFT Avg 3.5 MDFT
Intermediate	Chembuild 135 4.0 to 9.0 DFT Avg 5.0 MDFT	Carboguard 553 3.0 to 4.0 DFT Avg 3.5 MDFT
Finish	Hydroflon Series 700 2.0 to 3.0 DFT Avg 2.5 MDFT	Carboxane 950 2.0 to 3.0 DFT Avg 2.5 MDFT
Total	9.5 MDFT	8.0 MDFT

System HP-8
 INTERIOR/EXTERIOR EXPOSURE, NON-UV EXPOSURE (NON-IMMERSION)

Over-coating of localized inaccessible existing coating

Coat	Tnemec	Carboline
Existing	Existing coating system	Existing coating system
Spot Prime	Typoxy Series 27WB 4.0 to 14.0 DFT Avg 4.5 MDFT	NA
Intermediate	Enduratone Series 1029 2.0 to 3.0 DFT Avg 2.5 MDFT	NA
Finish	Enduratone Series 1029 2.0 to 3.0 DFT Avg 2.5 MDFT	NA
Total	5.0 MDFT	NA

DFT = Dry Film Thickness
 MDFT = Minimum Dry Film Thickness

2.03 EQUIPMENT

- A. The Contractor's surface preparation, coating and painting equipment shall be designed and suitable for the application of the specific materials herein specified. The Contractor shall submit a list of all applicable equipment owned by the Contractor. The Contractor's equipment shall be subject to the approval of the County based on the manufacturer's data.
- B. Effective oil and water separators shall be used in all compressed air lines serving spray painting and sandblasting operations to remove oil or moisture from the air before it is used. Separators shall be placed as far as practical from the compressor.
- C. The Contractor shall furnish all equipment for application of the paint and the completion of the Work in first-class condition and shall comply with recommendations of the paint manufacturer.

PART 3 - EXECUTION

3.01 GENERAL

- A. All coating and painting shall conform to the applicable requirements of the Society for Protective Coatings (SSPC) Manual (most recent edition). Any material applied upon improperly prepared surfaces shall be removed and redone to the satisfaction of the Owner at the sole expense of the Contractor.
- B. All Work shall be done by skilled craftsmen who are qualified to perform the required work and shall be done in a manner comparable to the best standards of practice found in that trade.

- C. The Contractor shall provide a supervisor to be at the work site during surface preparation, cleaning and coating operations. The supervisor shall have the authority to coordinate the work and make other decisions pertaining to the fulfillment of their contract.
- D. Prior to assembly, all surfaces that will be made inaccessible after assembly, shall be prepared as specified herein, and shall receive the paint or coating system as specified herein.
- E. Coating shall not be applied to wet or damp surfaces and shall not be applied in inclement weather. Do not apply when the surface temperature is less than 5° F above the dew point, or if relative humidity is greater than 85%. Dew or moisture condensation should be anticipated and if such conditions are prevalent, coating should be delayed until the surfaces are dry. Further, the day's coating should be completed well in advance of when condensation will occur, in order to permit the film a sufficient drying time prior to the formation of moisture.
- F. Any surfaces not specifically named in the Scope of Work, and not specifically exempted, shall be prepared, primed and painted in the manner and with materials consistent with these Specifications. The Owner shall select which of the manufacturer's products, whether the type is indicated herein or not, shall be used for such unnamed surfaces. No extra payment shall be made for this painting.
- G. Contractor shall inspect each pipe joint, pipe strap, personal barriers and appurtenances after providing access to the location but prior to commencing surface preparation activities. The Contractor shall immediately report leaks, damage, stripped bolts or nuts to the County.

3.02 SURFACE PREPARATION

- A. Solvent Cleaning: All dust, dirt, oil, or any contaminants that would affect the adhesion or durability of the finish coating must be removed before hand tool cleaning, abrasive blasting and prior to each coating layer application by cleaning per SSPC-SP1 "Solvent Cleaning."
- B. Defects: All ferrous metal surfaces shall be free of all defects. The Contractor shall remove by chipping or grinding all sharp edges; other defects shall be ground smooth in accordance with NACE Standard RPO178, Appendix C. Weld flux, weld spatter, slag and excessive rust scale shall be removed by SSPC-SP 11 Power Tool Cleaning to Bare Metal. All weld seams, sharp protrusions, and edges shall be ground smooth prior to surface preparation or application of any coatings.
- C. Gaskets: Existing gaskets in between flanged joints shall be cut or ground flush with the existing flanged joint prior to surface preparation or field blasting operations. The Contractor shall not field blast into bell and spigot joints or under tapping saddles. Contractor shall blast perpendicular to the pipe surface. SSPC-SP3 Power Tool Cleaning shall be used inside bells and against tapping saddles to avoid damage to gaskets and locking mechanisms.
- D. Field blasting cleaning for all surfaces shall be accomplished by dry sandblasting method unless otherwise directed, or the County provides written approval
 - 1. The abrasive used in blast cleaning shall produce an anchor profile in accordance with the recommendations of the manufacturer of the protective coating, which is to be applied to the surface being cleaned.

2. At all times during the blast cleaning operations, adequate means shall be employed to absolutely insure that existing protective coatings shall not be exposed to abrasion from blast cleaning operations.
3. All blast cleaned surfaces shall be carefully dried and cleaned prior to application of specified coatings. No coatings or paint shall be applied over damp or moist surfaces.
4. Field blasting and priming shall be completed on any particular area during the same workday, and the application of the primer shall follow immediately after surface preparation and cleaning prior to formation of any form of corrosion. If the surface is not primed within 8 hours, complete surface preparation shall be repeated.
5. The Contractor shall at all times keep the area of his work in reasonably clean condition shall not permit blasting materials to accumulate in an uncontrolled manner such as to constitute a nuisance or hazard to the satisfactory prosecution or the Work, operation of the existing facilities, public safety, environmental nuisances or public access.
6. "Touch-up systems will be same as original specification except that approved manufacturer's organic zinc-rich shall be used in lieu of inorganic zinc where this system was originally used. Also, strict adherence to manufacturer's complete touch-up recommendations shall be followed. Any questions relative to compatibility of products shall be brought to the attention of the COUNTY and Coating Manufacturer; otherwise, Contractor assumes full responsibility.
7. Areas that are inaccessible to abrasive blasting, including adjacent to concrete pedestals, tapping saddles, pressure gauges or other appurtenances shall be cleaned in accordance with SSPC-SP 11 "Power Tool Cleaning to Bare Metal" immediately adjacent to the area as approved by the County.

E. Specified Surface Preparation: All surfaces shall be cleaned per SSPC-SP1 "Solvent Cleaning". In addition to the surface preparation for the specific Service Condition, surface preparation shall be as follows:

Substrate	Condition	Surface Preparation
All Surfaces	All – Prior to Surface Preparation	SSPC-SP1 Solvent Cleaning
Steel	Exterior / Non-Immersion	SSPC-SP10 Near White Blast (NACE 2)
Steel	Exterior / Immersion	SSPC-SP5 White Metal Blasting (NACE-1)
Ductile Iron Pipe	Exterior / Non-Immersion	SSPC-SP6 Commercial Blast (NACE-3)
Ductile Iron Pipe	Exterior / Immersion	SSPC-SP10 Near White Blast (NACE 2)
Ferrous Metal	Exterior / Non-Immersion / Inaccessible to abrasive blasting	SSPC-SP 11 Power Tool Cleaning to Bare Metal
Galvanized Metals	Exterior / Non-Immersion	SSPC-SP 7 Brush-Off Blast (NACE 4)
PVC	Exterior / Non-Immersion	SSPC-SP1 Solvent Cleaning & Scarify by brush blast, power tools or hand sanding
Existing Coating System to be Over-Coated	Exterior / Non-Immersion	Scarify by brush blast, power tools or Hand Sanding with fine abrasive

1. Exposed Pipe: Bituminous coated pipe shall not be used in above ground or exposed locations and shall be factory primed for all new pipe installations. After installation all exterior, exposed flanged joints shall have the gap between adjoining flanges sealed with a flexible caulking shall meeting ASTM C-920 and shall be Sika Flex 1A or equal to prevent rust stains.
2. The Contractor shall not abrasive-blast or prepare more surface area than can be coated in the same day; prepare surfaces and apply prime coatings within an 8-hour period.
3. Contractor shall coordinate with the County prior to surface preparation. County approval shall be required prior to application of the prime coat.

3.03 APPLICATION EQUIPMENT

A. Brush and / or Rollers

1. Top quality, properly styled brushes and rollers shall be used. Rollers with a baked phenolic resin core shall be utilized.
2. The brushing or rolling shall be done so that a smooth coat, as nearly uniform in thickness as possible, is obtained. Brush or roller strokes shall be made to smooth the film without leaving deep or detrimental marks.
3. Surfaces not accessible to brushes or rollers may be painted by spray, by dauber or sheepskins, and paint mitt.
4. It may require 2 coats to achieve the specified dry film thickness if application is by brush and roller.

B. Air, Airless or Hot Spray

1. The equipment used shall be suitable for the intended purpose, shall be capable of properly atomizing the paint to be applied, and shall be equipped with suitable pressure regulators and gauges.
2. Paint shall be applied in a uniform layer, with a 50% overlap pattern. All runs and sags should be brushed out immediately or the paint shall be removed and the surface resprayed.
3. High build coatings should be applied by a crosshatch method of spray application to ensure proper film thickness of the coating.
4. Areas inaccessible to spray shall be brushed; if also inaccessible to brush, daubs or sheepskins shall be used, as the manufacturer authorizes.
5. Special care shall be taken with thinners and paint temperatures so that paint of the correct formula reaches the receiving surface.
6. Nozzles, tips, etc., shall be of sizes and designs as recommended by the manufacturer of the paint being sprayed.
7. Edges, corners, crevices, welds, and bolts shall be given a brush coat (stripe coat) of each coating. The stripe coat shall be applied by a brush and worked in both directions prior to spray application. Special attention shall be given to filling all crevices with coating.

3.04 WORKMANSHIP

A. General

1. Under no circumstances shall Asphaltic seal coats and mastics be overcoated.

2. Paints shall be mixed in proper containers of adequate capacity. All paints shall be thoroughly stirred before use and shall be kept stirred while using. No unauthorized thinners or other materials shall be added to any paint.
3. Only skilled painters shall be used on the Work, and specialists shall be employed where required.
4. Extreme care shall be exercised in the painting of all operable equipment, such as valves, electric motors, etc., so that the proper functioning of the equipment will not be affected.
5. The Contractor's scaffolding shall be erected, maintained, and dismantled without damage to structures, machinery, equipment or pipe. Drop cloths shall be used where required to protect the environment, the public, buildings, equipment, and areas surrounding the Work. All surfaces required to be clear for visual observations shall be cleaned immediately after paint application.
6. The prime coat shall be applied immediately following surface preparation within 8 hours of the same working day. All paint shall be applied by brushing, paint mitt and roller, conventional spraying, or airless spraying, using equipment approved by the paint manufacturer.
7. Each coat of paint shall be recoated as per manufacturer's instructions. Paint shall be considered recoatable when an additional coat can be applied without any detrimental film irregularities such as lifting or loss of adhesion.
8. Surfaces that will be inaccessible after assembly shall receive either the full specified paint system or three shop coats of the specified primer before assembly.
9. Finish colors shall be as specified per the color table in section 2.02 of this specification, and shall be factory mixed (i.e., the Contractor shall not tint the paint, unless the COUNTY and the Coating Manufacturer so authorizes.)
10. All shop-coated surfaces shall be protected from damage and corrosion before and after installation by treating damaged area immediately upon detection. Abraded or corroded spots on shop-coated surfaces shall be cleaned per SSPC-SP1 Solvent Cleaning" and then touched up with the same materials as the shop coat in accordance with the manufacturers instruction. At the discretion of the Owner, all shop coated surfaces that are faded, discolored, or that require more than minor touch up shall be field blast cleaned and repainted.

B. Field Coating: All painting at the site shall be designated "Field Coating".

1. All paint shall be at ambient temperature before applying, and no painting shall be done when the temperature is below 50 degrees F, in dust-laden air, when rain is falling, mist is present, when relative humidity exceeds manufacturer's recommendation when temperature is less than 5° F above the dew point, or until all traces of moisture have completely disappeared from the surface to be painted.
2. Protective coverings or drop cloths shall be used to protect existing appurtenances, concrete walkways, concrete structures, existing surfaces, the public, the environment and equipment. Care shall be exercised to prevent paint or coating overspray and spatter onto surfaces that are not to be painted. Surfaces from which such materials cannot be removed satisfactorily shall be painted or repainted, as required to produce, a finish satisfactory to the County.
3. All edges, corners, crevices, welds, hardware and irregular surfaces shall receive a brush coat (stripe coat) of the specified product for each coat prior to application of each complete coat.

4. Coating shall be applied in a neat manner that will produce an even film of uniform and proper thickness, with finished surfaces free from brush marks or other irregularities. Each coat shall be carefully examined and faulty material, poor workmanship, holidays, damaged areas and other imperfections shall be touched up prior to applying succeeding coats. Each coat shall be thoroughly dry and hard before the next coat is applied in accordance with the coating manufacturer's recommendations for drying time between coats. Coating shall be cleaned in accordance with SSPC-SP1 prior to the application of next coating. In no case shall coating be applied at a rate of coverage greater than the maximum rate recommended by the coating manufacturer.
5. Coating failures shall not be accepted and shall be entirely removed down to the substrate and the surface recoated. Failures include, but are not limited to, holidays, sags, checking, cracking, teardrops, fat edges, fisheyes, or delamination. Any repairs made on surfaces shall be repaired in accordance with the coating manufacturer's instructions.
6. Each coat shall be uniform in coverage and color. Successive coats of paint shall be tinted so as to make each coat easily distinguishable from each other with the final undercoat tinted to the approximate shade of the finished coat.
7. Painting shall be continuous and shall be accomplished in an orderly manner so as to facilitate inspection. Surfaces of exposed members that will be inaccessible after erection shall be cleaned and painted before erection.
8. All materials shall be applied in accordance with the manufacturer's instructions. If spray painting is required, Contractor shall accept all responsibility for any damage caused by overspray and/or drifting paint mist.
9. Caulking: The Contractor shall caulk all voids or interfaces including but not limited to: flanges, threads, nuts, saddles, gaps, voids or spaces between appurtenances and pipe to be coated immediately after the prime coat to prevent rust formation where ferrous metal is not accessible to surface preparation or blasting. Flexible caulking shall meet or exceed ASTM C-920 and shall be Sika Flex 1A or equal.

3.05 FIELD QUALITY CONTROL

At a minimum, the Contractor shall provide field quality control and verification of the coating film thickness utilizing the below methods.

- A. Wet Film Gauge. Both the Contractor and the County shall use a wet film gauge to verify the applied coating desired wet film thickness (WFT) to produce the required minimum DFT.

$$\text{Target WFT} = \text{County specified average MDFT} / \text{Volume Solids} \times 100\%$$

If thinner is applied per the manufacturer's recommendations, the volume of solids shall be reduced accordingly. Regardless of anchor profile, surface pattern or base metal calculation of the substrate, the gauge reported WFT shall meet the target WFT value for the substrate or previously coated surface to ensure the required average MDFT will be achieved.

- B. DFT Magnetic Gauge. Dry Film Magnetic Pull-Off Gauge (Type I) shall be utilized to determine DFT in accordance with SSPC-PA 2 "Measurement of Dry Coating Thickness with Magnetic Gages." The average of the readings shall meet the County-specified MDFT for each coating application. Electromagnetic Gauge (Type II) shall not be considered acceptable for use on this project.
- C. Holiday Testing: Each coating layer shall be holiday tested at the recommended 100-125 volts DC per mil in accordance with the latest edition of the following standards: NACE SP0188-2006, NACE Standard RP0490, ASTM G62 and per the manufacturers recommendations. All low voltage holiday testing shall be performed using a Tinker & Razor Model M-1 Holiday Detector, or equal. Areas found to have holidays shall be marked and repaired in accordance with the paint manufacturer's instructions.
- D. Destructive Testing: Destructive testing using a Tooke gauge shall only be utilized in cases of dispute regarding DFT. The County shall be permitted up to three (3) cuts using the Tooke Gauge and the Contractor shall be responsible for repairing the areas examined at no additional cost.
- E. Environmental Testing: humidity, dew point and temperature shall be constantly measured and logged. Any electronic gauges shall be first calibrated against a sling psychrometer each day.

3.06 INSPECTION OF SURFACES

- A. Before application of the prime coat and each succeeding coat, all surfaces to be coated shall be subject to inspection and approval by the County. The Contractor shall correct any defects or deficiencies before application of any subsequent coating. Coatings applied without County approval shall be removed and reapplied at no cost to the County.
- B. The Contractor shall provide the County access to all areas of the Work. All scaffolding or lifts shall be in compliance with OSHA requirements.
- C. The Contractor shall furnish samples of surface preparation and of painting systems to be used as a standard throughout the job, unless omitted by the County.
- D. When any appreciable time has elapsed or has exceeded the manufacturers recommendations between coatings, the County shall carefully inspect previously coated areas and surfaces that are damaged or contaminated, in the opinion of the County shall be cleaned and recoated at the Contractor's expense. Re-coating times of manufacturer's printed instructions shall be adhered to.
- E. Coating thickness shall be determined by the use of a properly calibrated "DeFelsko Positest FM" Type 1 Coating Thickness Gauge (or equal) for ferrous metal or a "Tooke" Paint Inspection gauge (or equal) for non-ferrous and cementitious surfaces. Please note that use of the "Tooke" gauge is classified as a destructive test.

3.07 PROTECTION, CONTAINMENT AND CLEAN-UP

- A. The premises shall at all times be kept free from accumulation of waste material and rubbish caused by employees or work. At the completion of the painting remove all tools, scaffolding, surplus materials, and all rubbish from and about the site and leave the area “broom clean” unless more exactly specified.
- B. It shall be the responsibility of the Contractor to protect at all times, in areas where painting is being done, floors, sidewalks, walls, bridges, environment, public property, equipment, vehicles, appurtenances, and finished surfaces adjacent to paint work. Cover all electric plates, surface hardware, nameplates, gauge glasses, etc., before start of painting work.
- C. The Contractor shall contain all spent abrasives, old paint chips, paint overspray and debris by means suitable to the County, including but not limited to, full shrouding of the area. The Contractor shall provide a complete design and plan of the intended shroud or cover. Care must be taken not to modify or damage the structure during the use of the shroud. If damage should occur, the Contractor is held responsible for all repairs. The Contractor's containment must be adequate enough to stop blasting residue from being released into the environment. There should be no visible emissions of particulate matter or visible deposits on the ground outside the containment area. Water jetting or wet abrasive blast cleaning for the purpose of removing paint and surface debris shall be conducted within a containment designed, installed, and maintained in order to capture paint chips and debris. Collection of the water is not required. Mesh containment materials that capture paint chips and debris while allowing the water to pass through shall have openings a maximum of 25 mils (625 microns) in greatest dimension. Low Pressure Water Cleaning for the purpose of removing chalk, dirt, grease, oil and other surface debris can be performed without additional containment provided paint chips are removed and collected prior to Low Pressure Water Cleaning (LP WC).
- D. At completion of the work, remove all paint where spilled, splashed, splattered, sprayed or smeared on all surfaces, hardware, equipment, painted, and unpainted surfaces.
- E. After completion of all painting, the Contractor shall remove from job site all painting equipment, surplus materials, and debris resulting from this work.
- F. The Contractor is responsible for the removal and proper disposal of all hazardous materials from the jobsite in accordance with Local, State, and Federal requirements as outlined by the Environmental Protection Agency.

END OF SECTION

**R&R PACKAGE 1 PUMP STATION IMPROVEMENTS
University at Rouse PS #3365, Lena Street PS #3309,
Allison Oaks PS #3893, Greenview Pines PS #3887 and
Bradford Cove PS #3890**



**TECHNICAL SPECIFICATIONS
BID SET**

**ORANGE COUNTY
UTILITIES DEPARTMENT**

Prepared By:

**BFA Environmental Consultants, Inc.
1230 E. Hillcrest Street
Orlando, Florida 32803**

JULY 2014

SECTION 11305
SUBMERSIBLE PUMPS AND APPURTENANCES

PART 1 - GENERAL

1.01 DESCRIPTION

- A. Scope of Work: This Section specifies the furnishing, installation, and testing of submersible pumps and associated equipment for the duplex pump station(s), complete, tested and ready for operation. The pumps and associated equipment covered under this Section include the following requirements:
1. Two submersible pumps and motors for each duplex pump station or three submersible pumps and motors for each triplex pump station.
 2. The following accessories and associated equipment are to be provided by the pump supplier for each duplex/triplex pump station:
 - a. pump control panel
 - b. lifting cables and hooks
 - c. hatches and frames
 - d. electrical cables and cable hangers
 - e. level indicators/floats
 - f. mounting elbows, adapters and anchor bolts
 - g. seamless guide/slide rails with Type 316 stainless steel upper guide rail brackets
 - h. pump base plates
- B. Operating Requirements: Pumping equipment provided under this Section shall conform to Table 11305-A "Submersible Pumps Schedule."

1.02 QUALITY ASSURANCE

- A. Unit Responsibility: All equipment including but not limited to the pumps, motors, control panel and level sensors, access hatch frames and covers (for wetwell and valve box), pump mounting elbows, guide rails, pump base plates, pump lifting cable, cable holder, and startup service shall be supplied by the pump supplier to insure unit responsibility.
- B. Factory Tests: The pump manufacturer shall perform the following tests on each pump before shipment from the factory:
1. Megger the pump for insulation breaks or moisture.
 2. Prior to submergence, the pump shall be operated dry and be checked for correct rotation.
 3. Pump shall be operated for 30-minutes in a submerged condition.
 4. Pump shall be removed from test tank, meggered immediately for moisture, oil plugs removed for checking lower seal, inspection plug removed for checking of upper seal and possible water intrusion of stator housing.

5. A written certified test report giving the above information shall be supplied with each pump at the time of shipment.
6. All ends of pump cables shall be fitted with a rubber shrink fit boot to protect cable prior to electrical installation.

C. The Contractor shall furnish and install equipment from a single manufacturer.

1.03 SHOP DRAWINGS AND SUBMITTALS

A. Submittals shall be submitted to the County for review and acceptance prior to construction in accordance with the General Conditions and specifications Section 01300 "Submittals."

B. Certified pump test performance for:

1. Flow, gpm
2. Total Dynamic Head (TDH), feet
3. NPSHr, feet
4. Input Power and Shaft Power, horsepower
5. Overall Efficiency and Pump Efficiency, %

C. Layout drawings showing installation details with dimensions specific for this application.

D. Shop Drawings for all associated equipment and accessories specified under this Section in accordance with Division 1 in sufficient detail to enable the County to determine compliance with all stated specification requirements.

E. Operating Instructions: Operating and maintenance data shall be furnished to the County as provided in the General Conditions and Division 1. The instructions shall be prepared specifically for this installation and shall include all required cut sheets and operating and maintenance instructions for personnel unfamiliar with such equipment.

F. Manufacturer's Certification

1. After acceptance of pump Shop Drawings, factory performance test data will be submitted for approval on each pumping unit.
2. Tests shall be in accordance with the standards of the Hydraulic Institute including head, capacity, brake horsepower and pump efficiency.
3. A written certified test report shall be supplied with each pump at the time of shipment.

1.04 PRODUCT DELIVERY STORAGE AND HANDLING

A. All equipment shall be delivered in suitable packages, cases or crates, and stored or placed as directed by the manufacturer. Each package shall have an identifying mark and a complete list showing contents. Equipment shall not be stored directly upon the ground.

- B. All equipment shall be lifted and handled in a manner so as not to damage or deform the equipment in any way and in any special way as instructed by the manufacturer.
- C. All parts and equipment shall be properly protected so that no damage or deterioration will occur during a prolonged delay from the time of shipment until installation is completed and the units and equipment are ready for operation. Finished surfaces of all exposed pump openings shall be protected by securely bolted wood planks. Finished iron or steel surfaces not painted shall be properly protected to prevent rust and corrosion during periods of storage and installation and shall be satisfactory to the County up to the time of the final acceptance test.

1.05 WARRANTY

- A. Warranty: The pump manufacturer shall warrant the pumps being supplied to the County against defects in workmanship and materials for a period of 5-years or 10,000-hours under normal use, operation and service. The warranty shall cover 100% of parts and labor for the time specified and shall not be prorated.

PART 2 - PRODUCTS

2.01 GENERAL

- A. All material supplied shall be one of the products specified in Appendix D "List of Approved Products" appended to these technical specifications.

2.02 MANUFACTURERS

- A. The Contractor shall furnish and install motor driven totally submersible sewage pumps and associated equipment as provided by those submersible sewage pump manufacturers listed in Appendix D "List of Approved Products" to meet the requirements set forth in Table 11305-A.

2.03 MATERIALS

- A. All hardware and accessories in the wetwell shall be Type 316 stainless steel.

2.04 PUMPS AND ACCESSORIES

- A. General
 1. Brass or stainless steel nameplates identifying the name of the manufacturer, voltage, phase, rated horsepower, speed and any other pertinent data shall be attached to each pump.
 2. Anchors and Fasteners: All necessary foundation bolts, plates, nuts, and washers shall be furnished by the equipment manufacturer and shall be Type 316 stainless steel.

- B. Pump Design: The pumps shall be capable of handling raw unscreened domestic wastewater and passing a minimum 3-inch diameter solid sphere.
- C. Casing: The stator casing and oil casing shall be of gray cast iron construction, with all parts coming into contact with sewage protected by a corrosion resistant paint proven to withstand an environment of raw wastewater.
- D. Impeller: The impeller shall be constructed of gray cast iron, ASTM A-48, class 30 – 40. All external bolts and nuts shall be Type 316 stainless steel. Each pump shall be provided with a replaceable metallic wear ring system to maintain pump efficiency. Impellers can be of the closed or open type. The closed type can utilize a single or double vane. The open type shall be single or double vane with a self-cleaning, adjustable cast iron wear plate. All impellers shall be dynamically balanced and of non-clog design capable of passing solids, fibrous material, and heavy sludge and constructed with long throughways with no acute turns.
- E. Mechanical Seals: Each pump shall be provided with a tandem double mechanical seal running in an oil or air reservoir, composed of two separate lapped face seals, each consisting of one stationary and one rotating tungsten carbide or silicone ring with each pair held in contact by a separate spring, so that the outside pressure assists spring compression in preventing the seal faces from opening. The compression spring shall be protected against exposure to the pumped liquid. Silicone carbide may be used in place of tungsten carbide for the upper and lower seal. The pumped liquid shall be sealed from the oil or air reservoir by one face seal and the oil reservoir from the air filled motor chamber by the other. The seals shall require neither maintenance nor adjustment and shall be easily replaced. Seal shall be held in place by locking ring. Conventional double mechanical seals are not acceptable. Cartridge seals are acceptable.
- F. Guide Rails, Lifting Cable, and Discharge Elbow
 - 1. The design shall be such that pumping units will be automatically connected to the discharge piping when lowered into place on the discharge connection. Pump removal for service or inspection will be by quick disconnect and hoist retrieve. Removal shall not require personnel to enter the wetwell nor shall nuts, bolts or fasteners require removal. Each pump shall be fitted with 6-feet of Type 316 stainless steel, minimum Grade 50, 3/4-inch chain attached to the lifting mechanism and air craft rated 1/4-inch stainless steel cable provided between the cable holder and the chain ("Grip-eye System", or acceptable equal), to permit raising the pump for inspection and removal using a closed chain hook and electric hoist. The lifting bail shall be constructed of Type 316 stainless steel for each pump.
 - 2. A sliding guide bracket shall be an integral part of the pumping unit and the pump casing shall have a machined connecting flange to connect with the cast iron discharge connection, which shall be bolted to the floor of the wetwell with stainless steel anchor bolts and so designed as to receive the pump discharge flange without the need of any bolts or nuts.

3. Sealing of the pumping unit to the discharge connection shall be accomplished by a simple downward motion with the entire weight of the pumping unit guided by two Schedule 40 welded seamless Type 316 stainless steel guide bars which will press it tightly against the discharge connection. All Type 316 seamless tubular stainless steel guides shall be 2-inch diameter for use with pumps up to 25-horsepower. Pumps greater than 25-horsepower shall use 3-inch diameter Type 316 seamless tubular stainless steel guides. No portion of the pump shall bear directly on the floor of the wetwell and no rotary motion of the pump shall be required for sealing. Sealing at the discharge connection shall be metal-to-metal contact of the pump discharge and mating discharge connection.
 4. The pump base elbow design shall be interchangeable such that it will provide a watertight connection for any of the specified or otherwise accepted pumps without requiring any special tools, gaskets or adapters. Assembly shall be capable of receiving a standard Flygt pump without special modification to either the pump or existing base elbow.
 5. Approved pump manufacturers, if necessary to meet the above specification, shall provide a sliding guide bracket adapter.
 6. Pump base elbow shall be bolted to a 1-inch-thick steel pump base plate which is anchored to the wetwell floor at six locations with 6-inch epoxy anchors. Pump base plate shall extend 6-inches beyond the pump volute and base elbow and trimmed to fit as necessary.
- G. Pump Motor: All motors shall be built in accordance with the latest NEMA, IEEE, ANSI and AFBMA Standards where applicable. The pump motor shall be housed in an air filled watertight casing and shall have Class H insulated windings which shall be moisture resistant. The motors shall be NEMA Design B rated 155°C maximum. Pump motors shall have cooling characteristics suitable to permit continuous operation in a totally, partially or non-submerged condition. The pump shall be capable of running continuously in a totally dry non-submerged condition under full load without damage for extended periods. Before final acceptance a field running test demonstrating this ability, with 24-hours of continuous operation under the above conditions, shall be performed for all pumps being supplied as required by the County. The motor shall be capable of a minimum of 10 starts per hour. Motors 25-horsepower and below shall be rated 230/460-volt, 3-phase and speed shall be nominal 1,750 RPM or less. Motors greater than 25-horsepower shall be 460 volt, 3-phase and speed shall be nominal 1,750 RPM or less. Pump motors shall be non-overloading over the entire published performance curve.
- H. Heat and Moisture Sensors: Each motor shall incorporate a minimum of one ambient temperature compensated overheat sensing device. This protective device shall be wired into the pump controls in such a way that if excessive temperature is detected the pump will shut down. This device shall be self-resetting.

- I. Cables: Cables shall be designed specifically for submersible pump applications and shall be properly sealed. A type CGB watertight connector with a neoprene gland shall be furnished with each pump to seal the cable entry at the control panel. The pump cable entry seal design shall preclude specific torque requirements to insure a watertight and submersible seal. The cable entry shall be comprised of a single cylindrical elastomer grommet, flanked by washers, all having a close tolerance fit against the cable outside diameter and the entry inside diameter and compressed by the entry body containing a strain relief function, separate from the function of sealing the cable. The assembly shall bear against a shoulder in the pump top. The cable entry junction chamber and motor shall be separated by a stator lead sealing gland or terminal board, which shall isolate the motor interior from foreign material gaining access through the pump top. Secondary sealing systems utilizing epoxy potting compounds may be used. The manufacturers shall supply a cable cap as part of the spare parts for each pump when this type of sealing system is used. All cables shall be continuous, without splices from the motor to the control panel, unless otherwise approved by the County. The junction chamber containing the terminal board shall be perfectly leak proof.
- J. Special Tools and Spare Parts
 1. Special Tools: Provide special tools for normal operation and maintenance in accordance with the Appendix B "Pump Station Start-Up Report" form.
 2. Spare Parts: The pump supplier will include at least one set of spare parts with a toolbox as detailed in accordance with Appendix B "Pump Station Start-Up Report" form.
- K. Pump Access Hatch and Frame
 1. Material: Structural aluminum or Type 316 stainless steel.
 2. Design
 - a. Liveload: 300-pounds per square foot.
 - b. Regular extruded angle section frame.
 - c. Hatch cover (diamond pattern) opens 90° (degrees) and locks automatically with stainless steel positive locking arm and release handle. Hatch cover shall be permanently embossed "CONFINED SPACE" and painted lettering shall not be acceptable. Each door shall be equipped with a recessed hasp enclosure.
 3. Frame attachments (all Type 316 stainless steel)
 - a. Upper guide rail holders
 - b. Lift cable holder
 4. Hatch hinges: heavy-duty Type 316 stainless steel hinges with tamper proof fasteners.
 5. Accessories
 - a. Lifting handle: Type 316 stainless steel.
 6. Finish: Mill finish with bituminous coating applied to exterior of frame.

PART 3 - EXECUTION

3.01 INSTALLATION

- A. All materials and equipment shall be installed as shown on the Drawings and as recommended by the manufacturers.

- B. Additional items of construction, such as concrete work, interior grouting, piping, vents, valves, controls, and other items necessary for the complete installation of the system shall conform to specific details on the Drawings and shall be constructed of materials conforming to the applicable portions of these Specifications.

3.02 INSPECTION, TESTING AND CERTIFICATION

- A. Inspection, Testing and Certification shall comply with Section 01650 "Pump Station Start-Up and Testing."

END OF SECTION

1

THIS PAGE LEFT BLANK INTENTIONALLY

TABLE 11305-A

SUBMERSIBLE PUMPS SCHEDULE FOR ROUSE/UNIVERSITY PS # 3365		
1. Manufacturer	Flygt	ABS
2. Model Number	CP3152.181 MT	PE 105/4
3. Impeller Number	63-434-00-5300	XFP150E-CB1
4. No. of Pumps Required	2	2
5. Pump Size, Inches	6	6
6. Primary Capacity, GPM / Total Head, Feet	910/41	830/41
7. Run-out Capacity, GPM / Total Head, Feet	1450/14	1480/12
8. Shut-off / Total Head, Feet	82	75
9. Motor, HP (NEMA Code)	20	14
10. Maximum Speed, RPM	1750	1760
11. Explosion Proof Motor Required (yes or no)	No	No
12. Voltage, Volts	230	230
13. Phase	3	3
14. Frequency, Hertz	60	60
15. Service	Raw Unscreened Sewage	Raw Unscreened Sewage
16. Minimum solid sphere size	4-inch	4-inch
17. Minimum Pump Efficiency at Primary Capacity, %	52	70
18. Submergence Requirement, Inches	17	14.1
19. Minimum Height of Base Elbow, Inches	14.5 (Top)	9.8 (Center)
20. Distance from Pump Volute to Base Plate, Inches	17.75	17.7

SUBMERSIBLE PUMPS SCHEDULE FOR LENA STREET PS # 3309		
1. Manufacturer	Flygt	ABS
2. Model Number		PE 35/6
3. Impeller Number		XFP100E-CB1
4. No. of Pumps Required		2
5. Pump Size, Inches		4
6. Primary Capacity, GPM / Total Head, Feet		190/21
7. Run-out Capacity, GPM / Total Head, Feet		480/10
8. Shut-off / Total Head, Feet		30
9. Motor, HP (NEMA Code)		4.7
10. Maximum Speed, RPM		1170
11. Explosion Proof Motor Required (yes or no)		No
12. Voltage, Volts		230
13. Phase		3
14. Frequency, Hertz		60
15. Service		Raw Unscreened Sewage
16. Minimum solid sphere size		3-inch
17. Minimum Pump Efficiency at Primary Capacity, %		48.9
18. Submergence Requirement, Inches		12.9
19. Minimum Height of Base Elbow, Inches		8.9 (Center)
20. Distance from Pump Volute to Base Plate, Inches		14.6

SUBMERSIBLE PUMPS SCHEDULE FOR ALLISON OAKS PS # 3893		
1. Manufacturer	Flygt	ABS
2. Model Number	CP3102	XFP 100E CB1.5-PE56/4
3. Impeller Number	433	ABS 1-VANE CHANNEL-195mm
4. No. of Pumps Required	2	2
5. Pump Size, Inches	4	4
6. Primary Capacity, GPM / Total Head, Feet	363/23	103/23.6
7. Run-out Capacity, GPM / Total Head, Feet	560/12	470/10
8. Shut-off / Total Head, Feet	0/42.4	0/29.6
9. Motor, HP (NEMA Code)	5	5
10. Maximum Speed, RPM	1745	1760
11. Explosion Proof Motor Required (yes or no)	YES	YES
12. Voltage, Volts	230	230
13. Phase	3	3
14. Frequency, Hertz	60	60
15. Service	Raw Unscreened Sewage	Raw Unscreened Sewage
16. Minimum solid sphere size	3 inch	3.1 inch
17. Minimum Pump Efficiency at Primary Capacity, %	61.9	37.6
18. Submergence Requirement, Inches	11	12.9
19. Minimum Height of Base Elbow, Inches	10.25 (TOP)	8.9 (Center)
20. Distance from Pump Volute to Base Plate, Inches	15.75	14.6

SUBMERSIBLE PUMPS SCHEDULE FOR GREENVIEW PINES PS # 3887

1. Manufacturer	Flygt	ABS
2. Model Number	CP3102	XFP 100E CB1.5-PE56/4
3. Impeller Number	435	ABS 1-VANE CHANNEL-185mm
4. No. of Pumps Required	2	2
5. Pump Size, Inches	4	4
6. Primary Capacity, GPM / Total Head, Feet	110/50	107/56.8
7. Run-out Capacity, GPM / Total Head, Feet	415/33	715/22
8. Shut-off / Total Head, Feet	0.5/58.7	0/66
9. Motor, HP (NEMA Code)	5	7.5
10. Maximum Speed, RPM	1745	1765
11. Explosion Proof Motor Required (yes or no)	YES	YES
12. Voltage, Volts	230	230
13. Phase	3	3
14. Frequency, Hertz	60	60
15. Service	Raw Unscreened Sewage	Raw Unscreened Sewage
16. Minimum solid sphere size	3 inch	3.1 inch
17. Minimum Pump Efficiency at Primary Capacity, %	46.4	29.6
18. Submergence Requirement, Inches	11	12.9
19. Minimum Height of Base Elbow, Inches	10.25 (TOP)	8.9 (CENTER)
20. Distance from Pump Volute to Base Plate, Inches	15.75	14.6

SUBMERSIBLE PUMPS SCHEDULE FOR BRADFORD COVE PS # 3890		
1. Manufacturer	Flygt	ABS
2. Model Number	CP3201	XFP PE3-PE6
3. Impeller Number	434	ABS 1-VANE CHANNEL-185mm
4. No. of Pumps Required	2	2
5. Pump Size, Inches	4	4
6. Primary Capacity, GPM / Total Head, Feet	276/37	216/41.1
7. Run-out Capacity, GPM / Total Head, Feet	750/11	690/15
8. Shut-off / Total Head, Feet	0/51	0/57
9. Motor, HP (NEMA Code)	7.5	6
10. Maximum Speed, RPM	1735	1765
11. Explosion Proof Motor Required (yes or no)	YES	YES
12. Voltage, Volts	230	230
13. Phase	3	3
14. Frequency, Hertz	60	60
15. Service	Raw Unscreened Sewage	Raw Unscreened Sewage
16. Minimum solid sphere size	3.1 inch	3.1 inch
17. Minimum Pump Efficiency at Primary Capacity, %	54.4	52.5
18. Submergence Requirement, Inches	11	12.9
19. Minimum Height of Base Elbow, Inches	10.25 (TOP)	8.9 (CENTER)
20. Distance from Pump Volute to Base Plate, Inches	15.75	14.6

THIS PAGE LEFT BLANK INTENTIONALLY

SECTION 13423
LEVEL MEASUREMENT

PART 1 - GENERAL

1.01 SUMMARY

- A. Section includes the following:
 - 1. Cord type float switch.

PART 2 - PRODUCTS

2.01 MANUFACTURERS

- A. Subject to compliance with specified requirements, see Appendix D for manufacturers offering products which may be incorporated in Work.

2.02 FLOAT SWITCH (CORD TYPE)

A. Free cable acting float switch shall be furnished to automatically detect liquid level change. Liquid rise of 1-inch from rest position shall operate float switch and reset will occur when liquid level drops 1-inch.

B. Float switch shall consist of type 316 stainless steel housing, flexible 3-conductor cable with a synthetic rubber jacket, and mercury switch. Inside float housing will be a (normally open/closed) mercury switch potted in epoxy. Electrical load for switch contacts shall be rated 115 volt AC at 0.5-horsepower inductive load.

C. Three-conductor cable shall be 14 AWG with 105-strands per conductor made for heavy flexing service and underwater use. A green grounding wire shall connect internally to float housing.

PART 3 - EXECUTION (NOT USED)

END OF SECTION

THIS PAGE LEFT BLANK INTENTIONALLY

SECTION 13430
PUMP STATION CONTROL PANELS

PART 1 - GENERAL

1.01 SUMMARY

- A. Section Includes:
1. **Intrinsically safe isolator relays.**
 2. **Terminal blocks.**

1.02 SUBMITTALS

- A. Shop Drawings covering the items included under this Section shall be submitted in accordance with Section 01300, "Submittals."

1.03 QUALITY ASSURANCE

- A. Regulatory Requirements
1. **Codes, Ordinances, and Industrial Standards: Design, testing, assembly, and methods of installation for materials, electrical equipment, and accessories proposed under this Section shall conform to National Electric Code and to applicable State and local requirements.**
 2. **UL listing and labeling of custom-built panels (UL 508) shall be adhered to under this Contract.**

PART 2 - PRODUCTS

2.01 MANUFACTURERS

Subject to compliance with specified requirements, approved manufacturers are listed in Appendix D "Orange County Utilities, Standards and Construction Specifications Manual", dated February 11, 2011.

2.02 CONTROL PANEL

- A. Panel Construction
1. **The Contractor shall furnish and install all the necessary panels, meter cabinets, disconnects, conductors, conduits, and other associated electrical components for a complete electrical system. All work shall conform to the latest national and local codes and be in strict conformance with Orange County standards as previously identified. All material and equipment shall be Underwriters Laboratories (UL) listed. All coordination for service and metering shall be accomplished by the Contractor at no additional cost to the County. The Work shall include complete testing of all equipment, components and wiring to**

- demonstrate proper functioning of the system.
2. **The manufacturer of the control panel shall be UL certified and provide data to indicate that the manufacturer has a minimum of 3-years experience in the building of pump control panels.**
 3. **The duplex pump control panel shall be housed in a NEMA 12/3R, Type 316, 14-gauge stainless steel enclosure, with drip shield and door gasket. The control panel door shall be operated by a 3-point latch. An additional remote access terminal strip with thirty additional terminal blocks shall be added for SCADA. Enclosure shall have provisions for padlocking the door and a dead front inner door unit for mounting controls. All exterior hardware and hinges shall be stainless steel. All LCD screens shall have an aluminum sunshield painted white with hinged flap covering the screen surrounding the manufacturer's enclosure.**
 4. **There shall be permanently affixed to the interior side of the enclosure door both a nameplate and a 10-inch by 12-inch pocket for log sheet storage. The nameplate shall contain the following information:**
 - a. voltage
 - b. phase
 - c. rated horsepower
 - d. rpm
 - e. date manufactured
 - f. pump and control panel manufacturer's name
 - g. pump data
 - h. impeller data
 - i. operating point including design flow and head
 - j. kilowatt input
 - k. amperes at the operating point and at least 2 other points on the pump curve
 - l. pump serial numbers.
 5. **The control panel enclosure shall be UL 50 type NEMA 3R listed. Overhead T-8 fluorescent lighting shall be controlled by a single pole switch installed inside of the control panel. Light shall be mounted on the inside of the door.**
 6. **The control panel shall consist of a main circuit breaker and generator breaker with mechanical interlock, an emergency power receptacle, a circuit breaker and magnetic starter for each pump motor, and 20-ampere, 120 volt circuit breakers as required. The main circuit breaker and generator circuit breaker shall be equal in rating. Each panel shall contain an additional 20-ampere breaker for SCADA purposes. All circuit breakers shall be operable through the dead front inner door. Additional multi-lug assemblies shall be provided to prevent more than 1-wire per lug. All circuit breakers shall be molded case. The control panel shall respond to liquid level float switches and other approved methods specified by Appendix D "List of Approved Products", to automatically start and stop pumps as well as sound an alarm upon high or low wetwell levels. Control switches shall provide means to operate each pump manually or automatically. When operated in the automatic mode, the control assembly shall provide means to manually select or automatically alternate the position of the "lead" and "lag" pumps after each pumping cycle. A float type liquid level control system shall continuously monitor wetwell liquid level and control operation of the low-level cutoff for the pumps and shall operate off a 24-VAC circuit.**

7. **The control panel shall operate a minimum of 2 electrical submersible pumps at the power characteristics specified. The control function shall provide for the operation of the lead pump under normal conditions. If the incoming flow exceeds the pumping capacity of the lead pump, the lag pump shall automatically start to handle this increased flow. As the flow decreases, pumps shall be cut off at the elevation as shown on the Drawings. Pumps shall alternate positions as lead pump at the end of each cycle. A failure of the alternator shall not disable the pumping system. The alternator shall include a safe, convenient method of manual alternation and also have provisions to prevent automatic alternation without disturbing any wiring. Should the "pump off" regulator fail, the system shall keep the station in operation.**
8. **The control panel shall be compatible with both of the manufacturers' pumps listed in Table 11305-A - Submersible Pumps Schedule.**

B. Power Supply and Main Disconnect

1. **Power supply to the control panel shall be 120/240 volt, 3-phase, 4-wire (Open Delta or Closed Delta from Electric Utility) or 480 volt, 3-phase, 3-wire (Y). Minimum service shall be 100-amperes. Single-phase power shall not be accepted.**
2. **A lockable, non-fused disconnect shall be used for service main disconnects at all stations. In all pump stations, a main disconnect shall be installed between the meter and the panel. Exception: At pump stations with a generator and transfer switch, provide molded case circuit breaker located ahead of transfer switch for service main disconnect.**
3. **Disconnect shall be rated for the maximum available fault current from the utility serving the pump station with electrical power as shown on the electrical plans.**
4. **On all 480 volt systems, an additional UL approved lockable, non-fused, safety type switch utility service disconnect shall be installed ahead of the meter.**
5. **Contractor shall be responsible for coordination of the electrical service with the utility providing power for the installation.**

C. Motor Circuit Protectors

1. **Each pump motor shall be protected by a 3-pole molded case circuit breaker (See Appendix D "List of Approved Products"). The motor circuit breaker shall be operated by a toggle type handle and shall have a quick make, quick break over-center switching mechanism that is mechanically trip free from the handle so that the contacts cannot be held closed against a short circuit and abnormal currents which cause the motor circuit breaker to trip. Tripping shall be clearly indicated by the handle automatically assuming a position midway between the normal "on" and "off" positions. All latch surfaces shall be ground and polished. All poles shall be so constructed that they open, close, and trip simultaneously. Motor circuit breaker must be completely enclosed in a high strength glass polyester molded case. Ampere ratings shall be clearly visible. Contacts shall be of non-welding silver alloy. Arc extinction must be accomplished by means of arc chutes. A manual push to trip button shall be provided for manual exercising of the trip mechanism.**

D. Motor Starter and Selector Switches

1. **The panel shall contain a motor starter for each motor. The motor starter shall be across-the-line non-reversing magnetic starter with individual mechanical overload protection on each power leg with reset installed through the dead front inner door unit. Provide solid-state soft start overloads for motors greater than 50-horsepower. Local power company regulations shall govern.**
2. **Selector switches shall be installed on the face of the inner dead front door unit. Selector switch shall be a heavy-duty NEMA 4X "Hand Off Auto" 3-position switch to control the operation mode of each pump motor starter.**
3. **Motor Disconnect: Where pump motor disconnect and starter is not mounted within site of pump wetwell, (where electrical equipment is mounted within a building or other enclosure) provide additional NEMA 4X stainless steel non-fused disconnect for each pump within site of pump location.**

E. Pump Alternator: A solid-state alternator shall be provided to change the pump starting sequence on each pumping cycle. A 3-position alternator test switch shall be provided to control the alternation operation. Switch positions to include the "auto" to provide normal automatic sequence, "off" position to disable alternator, and "test" position with a spring return to allow the alternating of the pump sequence to check alternator operation.

F. Lights and Alarms

1. **Indicator Lights: There shall be installed on the face of the dead front inner door, heavy-duty NEMA 4X indicator lights as shown on the STANDARD DRAWINGS.**
2. **High Level Alarm: A vapor-proof red light shall be mounted on top of the panel and horn shall be mounted on the side of the panel for high level alarm. Also, there shall be an alarm silence pushbutton on the dead front inner door and a silence relay which will silence the horn and automatically reset when these signals are restored to normal. The pushbutton shall be heavy-duty oil tight. The red globe shall be the screw on type.**

G. Emergency Power Receptacle: This item shall be required on all stations up to and including 200-ampere main service as approved in Appendix D "List of Approved Products."

H. Additional Control Panel Requirements

1. **Wiring**

- a. All power wires shall be THW or THWN 75°C insulated stranded copper conductors and shall be appropriately sized for the given load application. All control circuit wire shall be type THW/THWN stranded. All wiring within the enclosure shall be neatly routed by the use of slotted type wiring duct with snap on type covers.
- b. Interior wiring shall be neatly bundled with nylon ties and include sufficient loop across the hinges to prevent wire damage, with each end of conductor marked (ID), color: red, 24 volt; white, neutral; black, 120 volt.

2. **Terminal Points:** Terminal points of all terminal strips shall be permanently identified. All terminal numbers and identifying nomenclature shall correspond to and be shown on electrical diagrams. All wiring shall be permanently identified with heat shrink preprinted labels and be shown on electrical schematic diagrams.
3. **Engraved and/or etched Nameplates:** All equipment enclosures, circuit breakers, control switches, indicator pilot lights and other control devices shall be identified with permanently affixed legend plates and lamoid type engraved nameplates where applicable. Nameplates may also be permanently etched into dead front cover of control panel.
4. **Transient Voltage Surge Suppressor (TVSS):** A transient voltage surge protector shall be included and wired to protect motors and control equipment from lightning induced line surges. All surge protectors shall be UL approved and installed per respective power company requirements and manufacturer's specifications. TVSS shall be attached to the load side of the station main disconnect and be mounted in a separate NEMA 4X enclosure.
 - a. The TVSS unit shall be UL listed and labeled as per UL 1449 Current edition.
 - b. The unit shall meet "Testing Requirements" of IEEE 62.41 and 62.45.
5. **Elapsed Time Meters:** Elapsed time meters shall be 115 volt not reset type and shall totalize pump running time in hours and tenths of hours to 99999.9 hours.
6. **Convenience Receptacle:** On the face of the dead front inner door unit, there shall be installed a 20-ampere 120 volt, duplex convenience receptacle. It shall be provided with its own single pole, 20-ampere circuit breaker for protection. Ground fault interrupt type shall be required.
7. **SCADA Circuit Breaker:** A 20A-1P, 120-VAC circuit shall be provided for connection to SCADA equipment provided for the pump station.
8. **Control Terminal Blocks:** Control terminal blocks shall be of the clamp screw type, rated for 600 volts. Amperage rating shall accommodate the control circuit amperage. An additional 30-space terminal strip shall be installed in the cabinet for future use, with RTU equipment.
9. **Control Power Transformers**
 - a. On 480 volt control panels, there shall be a control 480/120 volt power transformer with a minimum size of 2.52 KVA to provide 120-VAC power for: coils for starters, 20-ampere duplex receptacle, indicator pilot lights, alarm horn, alarm light, pump alternator, elapsed time meters, SCADA control panel, etc. The secondary side shall have 1 leg fused and the other grounded.
 - b. A 120/24-VAC 75 VA control power transformer shall provide power for float switches.
 - c. On 120/240 volt control panels an additional transformer may be required if SCCR is above 5000 amperes.
10. **Control Relay:** The level control relays shall operate from 24-VAC. They shall be enclosed, plug in 8-pin type with octal style screw terminal sockets.
11. **Electrical Schematic:** There shall be permanently affixed to the interior side of the exterior enclosure door an electrical schematic diagram and a copy supplied to County personnel at start up. The schematic shall be laminated and include the rated amperage and voltage for all components.

12. **Phase Monitor:** For all 240 volt stations an 8-pin plug in type phase monitor shall be provided for protection of electrical components due to phase loss. Adequate dummy pin protection shall be provided to prevent accidental interchanging of the 8-pin phase monitor with the 8-pin alternator. All 480 volt stations shall have surface mount type phase monitors. An approved breaker shall provide phase monitor protection. Fuses shall not be used for phase monitor protection.
13. **Panel Support:** Main support posts shall be minimum 3-inch, schedule 40, Type 316 stainless steel with Type 316 stainless steel cap. All other control panel support brackets and hardware shall be Type 316 stainless steel. Hardware shall include U-channel strut systems, brackets, nuts, bolts, washers, toggle bolts, clamps, straps, etc.

PART 3 - EXECUTION (NOT USED)

END OF SECTION

SECTION 15062
DUCTILE IRON PIPE AND FITTINGS

PART 1 - GENERAL

1.01 DESCRIPTION

- A. Scope of Work: Furnish all labor, materials, equipment and incidentals required and install, all ductile iron piping, ductile iron fittings, and appurtenances as shown on the Drawings and as specified herein.
- B. General Design: The equipment and materials specified herein are intended to be standard types of ductile iron pipe and cast or ductile iron fittings for use in transporting wastewater, potable water, and reclaimed water.

1.02 QUALITY ASSURANCE

- A. Qualifications: All of the ductile iron pipe and ductile or cast iron fittings shall be furnished by manufacturers who are fully experienced, reputable, and qualified in the manufacture of the materials to be furnished. The pipe and fittings shall be designed, constructed and installed in accordance with the best practices and methods and shall comply with these specifications as applicable.
- B. Standards:
 - 1. ANSI A 21.50/AWWA C150
 - 2. ANSI A-21.51/AWWA C151
 - 3. ANSI A-21.41/AWWA C104
- C. Factory Tests: The manufacturer shall perform the factory tests described in ANSI A-21.51/AWWA C151.
- D. Quality Control
 - 1. The manufacturer shall establish the necessary quality control and inspection practice to ensure compliance with the referenced standards. All pipe on this Project shall be supplied by a single manufacturer unless otherwise accepted in writing by the County.
 - 2. In addition to the manufacturer's quality control procedures, the County may select an independent testing laboratory to inspect the material at the foundry for compliance with these specifications. The cost of foundry inspection requested by the County will be paid for by the County.

1.03 SUBMITTALS

A. Materials and Shop Drawings

1. Submit Shop Drawings and piping layouts, including areas within and under buildings and structures. Shop Drawings shall include dimensioning, methods and locations of supports and all other pertinent technical specifications. Show locations of all field cuts. Shop Drawings shall be prepared by the pipe manufacturer. Shop Drawings for piping within and under buildings and structures shall be submitted within 30-days of Execution of Contract.

B. Operating Instructions: Submit Operation and Maintenance Manuals in accordance with Section 01001 "General Work Requirements."

C. Manufacturer's Certification

1. Submit manufacturer's sworn certification of factory tests and test results.

1.04 PRODUCT DELIVERY, STORAGE AND HANDLING

The Contractor shall be responsible for all materials furnished and stored until the date of project completion. The Contractor shall replace, at his expense, all materials found to be defective or damaged in handling or storage. The Contractor shall, if requested by the County, furnish certificates, affidavits of compliance, test reports, samples or check analysis for any of the materials specified herein. All pipe delivered to project site for installation is subject to random testing for compliance with the designated specifications.

A. Delivery and Storage: Delivery and storage of the materials shall be in accordance with the manufacturer's recommendations. Stored pipe shall be covered for protection against contamination and UV light. Joint gaskets shall be stored in clean, dark and dry location until immediately before use.

B. Handling: Care shall be taken in loading, transporting and unloading to prevent damage to the pipe and fittings and their respective coatings. Pipe or fittings shall not be rolled off the carrier or dropped. Pipe shall be unloaded by lifting with a forklift or crane. All pipe or fittings shall be examined before installation and no piece shall be installed which is found to be defective. Pipe shall be handled to prevent damage to the pipe or coating. Accidental damage to pipe or coating shall be repaired to the satisfaction of the County or be removed from the job. When not being handled, the pipe shall be supported on timber cradles or on level ground, graded to eliminate all rock points and to provide uniform support along the full pipe length. When being transported, the pipe shall be supported at all times in a manner which will not permit distortion or damage to the lining or coating. Any unit of pipe that, in the opinion of the County, is damaged beyond repair by the Contractor shall be removed from the site.

PART 2 - PRODUCTS

2.01 MATERIALS

A. Ductile Iron Pipe

1. Standards: ANSI A-21.50, AWWA C150 and ANSI A-21.51, AWWA C151
2. Thickness/Pressure Class:
 - a. Below ground piping: Class 350 (4-inch to 12-inch), Class 250 (16-inch to 24-inch) and Class 200 (30-inch to 64-inch) unless otherwise noted or specified.
 - b. Above ground piping: Flanged, Class 350 (minimum) unless otherwise noted or specified.
3. Joints
 - a. Push-on or Mechanical Joints (below ground piping)
 - (1) Standards: ANSI A21.11, AWWA C111
 - (2) Class: 350-psi working pressure rating
 - (3) Gaskets
 - (a) Potable and Reclaimed Water Service: Styrene Butadiene Rubber (SBR) ring type.
 - (b) Wastewater Service: Neoprene rubber ring type.
 - b. Flanged (above ground or inside below ground vaults)
 - (1) Standards: ANSI A21.15, ANSI B16.1
 - (2) Class: 125-pound factory applied screwed long hub flanges, plain faced without projection.
 - (3) Gaskets
 - (a) Spans less than 10-feet: full-face 1/8-inch thick neoprene rubber
 - (b) Spans greater than 10-feet: Toruseal gaskets as manufactured by American Cast Iron Pipe or acceptable equal.
 - c. Restrained Joints
 - (1) Manufacturers: Lok-Ring system (all sizes) or locking type gasket systems (for 16-inch diameter and smaller) as manufactured by American Ductile Iron Pipe; MEGALUG System as manufactured by EBBA Iron; or acceptable equal.
 - (2) Class: 250-psi minimum design pressure rating.
 - (3) Standard mechanical joint retainer glands shall not be acceptable.
 - d. Joint Accessories
 - (1) Mechanical joint bolts, washers and nuts: Ductile iron or Corten steel.
 - (2) Flanged joint bolts, washers and nuts: 316 stainless steel with bolts and nuts conforming to ASTM A193 Grade B8M.
 - e. Pipe Length (below ground installation): 20-foot maximum nominal length.
4. Pipe Identification
 - a. Each length of pipe shall bear the name or trademark of the manufacturer, the location of the manufacturing plant, and the class or strength classification of the pipe. The markings shall be plainly visible on the pipe barrel. Pipe which is not clearly marked is subject to rejection. The Contractor shall remove all rejected pipe from the project site within five NORMAL WORKING DAYS.

B. Fittings

1. Ductile iron fittings 4-inch through 24-inch shall be pressure rated at 350-psi minimum, except flanged joint type fittings which shall be rated at 250-psi minimum. All 30-inch and larger fittings shall be pressure rated to 250-psi minimum. All fittings shall conform to either ANSI/AWWA C110/A21.10 and/or C153/A21.53, latest revision, and shall be ductile iron only. All fittings shall be cast and machined allowing the bolt holes to straddle the vertical centerline. All fittings shall be designed to be capable to withstand, without bursting, hydrostatic tests of three times the rated water working pressure. All fittings shall have a date code cast (not printed or labeled) with identification of date, factory, and the factory unit from which it was cast and machined. Fittings shall have the pressure rating, nominal diameter of openings, manufacturer's name, and the country where cast and number of degrees or fraction of the circle distinctly cast on them. Ductile iron fittings shall have the letter "DI" or "Ductile" cast on them.
2. Joints shall be as described for ductile iron pipe for above ground/exposed and buried service.
3. All potable water main fittings shall have NSF 61 certification, and ISO 9001 certification for both the foundry and manufacturer. The NSF 61 certification shall be issued on all coatings and linings, from the said manufacturers that are used for potable water applications.

2.02 COATINGS, LININGS AND IDENTIFICATION MARKINGS

A. Exterior Coatings

1. Below ground/buried or in a casing pipe:
 - a. Type: Asphaltic coating, 1.0-mil DFT in accordance with ANSI/AWWA A21.51/C151.
 - b. Markings: (continuous 3-inch wide strip within top 90 degrees of pipe - min. drying time 30-minutes before backfill).
 - c. Color:
 - (1) Raw Wastewater: Safety Green
 - (2) Reclaimed Water: Purple (Pantone 522C)
 - (3) Potable Water: Safety Blue
2. Above ground/Exposed/In vaults
 - a. Coatings and coating testing for ductile iron pipe and fittings for above ground/exposed applications shall be accordance with Division 9. Primer, intermediate and final coats whether shop or field applied shall be compatible and applied in accordance with the coating system manufacturer's recommendations. Refer to Appendix D "List of Approved Products" for approved coating system suppliers. Asphaltic seal coat applied to the exterior of above ground piping and fittings shall be blasted and completely removed prior to coating per NACE-3/SSPC-SP6 commercial blast cleaning minimum angular anchor profile of 1.5-mils.

- b. Color
 - (1) Raw Wastewater: Safety Green
 - (2) Reclaimed Water: Purple (Pantone 522C)
 - (3) Potable Water: Safety Blue
 - 3. Inside Wetwell
 - a. All piping inside of wastewater wetwell shall be 316 stainless steel.
- B. Interior Lining (Applied by pipe manufacturer)
- 1. Wastewater: Interior coating shall be Protecto 401 (amine cured novalac epoxy containing at least 20% by volume of ceramic quartz pigment) for all pipe and fittings. All ductile iron pipe and fittings shall be delivered to the manufacturer certified applicator without asphalt, cement lining, or any other lining on the interior surface and no coating shall have been applied to the first 6-inches of the exterior of the DIP spigot ends. Minimum surface preparation shall be SSPC-SP 1 Solvent Cleaning method to remove oil and grease followed by NACE-4 / SSPC-SP7 Brush-Off Blast Cleaning. Protecto 401 shall be applied within 12-hours of surface preparation to the interior of the pipe and fittings so as to obtain a continuous and relatively uniform and smooth integral lining with a total minimum dry film thickness of 40-mils for the complete system. No lining shall take place when the substrate or ambient temperature is below 40°F. The lining shall not be used on the face of the flange of fittings or flanged pipe. The system shall be holiday free and holiday testing (minimum 2000 volts) shall be conducted and pinholes shall be repaired prior to shipping.
 - 2. Potable Water and Reclaimed Water: Interior coating shall be fusion-bonded epoxy (FBE) or Cement Mortar lined with asphaltic seal coat.
 - a. FBE for Fittings: Fittings shall be supplied with a FBE coating, both inside and outside for total protection including flanged and buried fittings. The exterior of flanged fittings for above ground assemblies shall adhere to final exterior coating requirements per 3119 2.04 A. The FBE coating system shall meet or exceed ANSI/AWWA C-550 and C116/A21.116 requirements and shall have NSF 61 certification. FBE coating thickness shall be 6 to 8-mils dry film thickness, shall be applied for secure adhesion, shall have a smooth surface and shall be holiday free.
 - b. Cement mortar lining with a seal coat of asphaltic material shall be in accordance with ANSI/AWWA A21.4/C104.
- C. Polyethylene Encasement is required when pipe is within 10-feet of a gas main or as indicated on the Drawings:
- 1. Standard: ANSI A 21.5/AWWA C105, 8-mil minimum thickness.

2.03 LOCATION MARKERS AND LOCATION WIRE

A. Electronic Markers and Locator System (for reclaimed water and wastewater ONLY)

1. Markers: Markers shall consist of a passive device capable of reflecting a specifically designated repulse frequency tuned to the utility (service) being installed. Markers shall be color coded in accordance with American Public Works Association's "Utility Locating and Coordinating Council Standards." Colors shall be: Wastewater and Reclaimed Water - #1404 Green. Markers shall be full range. Markers shall be installed directly above the centerline of the respective pipeline at intervals not to exceed 100-feet, at each fitting (tees, wyes, crosses, reducers, plugs, caps and bends) or change in horizontal direction and at each valve along the pipeline. Markers shall be hand backfilled to 1-foot above the pad and have a finished depth of burial of not less than 2-feet or more than 6-feet. No separate payment shall be made for furnishing and installing the respective frequency and color-coded electronic pad type marker.
2. Locator System: Marker locator set shall be the Scotch Mark EM II Electronic Marker Locator Path Tracing Receiver, or acceptable equal. The Contractor shall furnish 1-locator set for each type of service piping installed on the project (i.e.: reclaimed water, wastewater) to the County. Each unit shall incorporate the following features and accessories:
 - a. Unit(s) shall be tuned to the proper frequency for each type (service) of piping.
 - b. Field strength meter that provides visual indication of the return signal.
 - c. Function switch for selection of operation mode.
 - d. Sensitivity control to adjust the receiver gain.
 - e. Audio speaker for signal response.
 - f. Battery access panel containing condensed operating instructions.
 - g. Auxiliary headset and heads set jack.
 - h. Permanently attached shoulder straps.
 - i. Rugged shockproof and weatherproof storage/carrying case.
3. Manufacturer: System shall be Scotch Mark Locator System, or acceptable equal.

B. Location Detection Wire

1. Materials: Continuous, insulated 10-gauge copper wire (color to match pipe identification).
2. Installation: Directly above (1-inch maximum) centerline of pipe terminating at top of each valve box collar and be capable of extending 12-inches above top of box (stored inside the 2-inch brass pipe through the valve box collar) in a manner so as not to interfere with valve operation. For direction drilling installations, a minimum of 2 (two) 10-gauge wires shall be pulled along with the pipe.
3. Continuity: Continuity of wire to be tested using Metrotech 810/9860 or acceptable equal.

PART 3 - EXECUTION

3.01 INSTALLATION

- A. Ductile iron pipes shall be installed in accordance with AWWA C600 and AWWA Manual M-42. When a restraining type gasket is used, the bell shall be painted red.
- B. Underground Ductile Iron Pipe and Fittings.
 - 1. Bedding firm, dry and even bearing of suitable material. Blocking under the pipe will not be permitted.
 - 2. Placement
 - a. Alignment: In accordance with lines and grades shown on the Drawings. Deflection of joints shall not exceed 75% of the values recommended by the pipe manufacturer.
 - b. The Contractor shall provide line and grade stakes at a 100-foot maximum spacing and at all line and/or grade change locations. The Contractor shall provide temporary benchmarks at a maximum of 1,000-foot intervals. The minimum pipe cover shall be 30-inches below the finished grade surface or 30-inches below the elevation of the edge of pavement of the road surface whichever is greater.
 - c. All pipe and fittings shall be inspected prior to lowering into trench to insure no cracked, broken or otherwise defective materials are being used. All homing marks shall be checked for the proper length so as to not allow a separation or over homing of connected pipe. Homing marks incorrectly marked greater than 1-inch shall result in rejection of pipe and removal from site. The Contractor shall clean ends of pipe thoroughly and remove foreign matter and dirt from inside of pipe and keep clean during and after installation.
 - d. Proper implements, tools and facilities shall be used for the safe and proper protection of the Work. Pipe shall be lowered into the trench in such a manner as to avoid any physical damage to the pipe. Pipe shall not be dropped or dumped into trenches under any circumstances.
 - e. Trench Dewatering and Drainage Control: Contractor shall prevent water from entering trench during excavation and pipe-laying operations to the extent required to properly grade the bottom of the trench and allow for proper compaction of the backfill. Pipe shall not be laid in water.
 - f. Pipe Laying in Trench: Dirt or other foreign material shall be prevented from entering the pipe or pipe joint during handling or laying operations and any pipe or fitting that has been installed with dirt or foreign material in it shall be removed, cleaned and re-laid. Pigging of pipe may be used to remove foreign materials in lieu of flushing. At times when pipe installation is not in progress, the open ends of the pipe shall be closed by a watertight plug or by other means approved by the County to ensure absolute cleanliness inside the pipe. The pipe shall be installed with the color stripe and pipe text on the top of pipe.

3. Cutting: When required, cutting shall be done by machine, leaving a smooth cut at right angles to the axis of the pipe. Cut ends of the pipe to be used with a push-on bell shall be beveled. Bare metal exposed at ends of the pipe shall be field coated in accordance with pipe manufacturer's recommendations. Cut pipe for wastewater service shall have exposed bare metal ends repaired with Protecto 401 using the coating system manufacturer's field repair kit.

4. Joints

- a. Joint Placement

- (1) Push on joints: Pipe shall be laid with the bell facing upstream. The gasket shall be inserted and the joint surfaces cleaned and lubricated prior to placement of the pipe. After joining the pipe, a metal feeler shall be used to verify that the gasket is correctly located.
 - (2) Mechanical Joints: Pipe and fittings shall be installed in accordance with the "Notes on Method of Installation" under ANSI A21.11/AWWA C111. The gasket shall be inserted and the joint surfaces cleaned and lubricated with soapy water before tightening the bolts to the specified torque.

- C. Thrust Restraint

1. General: Thrust restraint shall be accomplished by the use of mechanical restraining devices unless specifically identified otherwise on the Drawings or herein.
 2. Length of Restrained Joints: In accordance with the lengths listed in the table as shown on the Drawings.

- D. Installation of Pipes on Curves

1. Maximum deflections at pipe joints, fittings and laying radius for the various pipe lengths shall not exceed 75% (percent) of the pipe manufacturer's recommendation.

3.02 CLEANING AND FIELD TESTING

- A. General: At the conclusion of the Work, the Contractor shall provide all associated cleaning and field testing as specified in other related sections of these specifications.

END OF SECTION

SECTION 15064
POLYVINYL CHLORIDE (PVC) PIPE AND FITTINGS

PART 1 - GENERAL

1.01 DESCRIPTION

- A. Scope of Work: Furnish all labor, materials, equipment and incidentals required and install and test all polyvinyl chloride (PVC) piping, fittings and appurtenances as shown on the Drawings and specified herein.
- B. General Design: The equipment and materials specified herein are intended to be standard types of PVC pipe and ductile iron fittings for use in transporting wastewater, reclaimed water, and water.

1.02 QUALITY ASSURANCE

- A. Qualifications: All of the PVC pipe and ductile iron fittings shall be furnished by manufacturers who are fully experienced, reputable, and qualified in the manufacture of the materials to be furnished. The pipe and fittings shall be designed, constructed, installed in accordance with the best practices and methods and shall comply with these specifications as applicable.
- B. Standards:
 - 1. AWWA C900/C905
 - 2. ASTM D1784 / D1785 / D2241 / D2466 / D2564 / D2729 / D2774 / D3034 / D3139 / D3212
 - 3. NSF 14
 - 4. UNI-B-1 through 5
- C. Factory Tests: The manufacturer shall perform the factory tests described in Section 3 - AWWA C900/C905.
- D. Quality Control:
 - 1. The manufacturer shall establish the necessary quality control and inspection practice to ensure compliance with the referenced standards.
 - 2. In addition to the manufacturer's quality control procedures, the County may select an independent testing laboratory to inspect the material at the production facility for compliance with these specifications. The County will pay for the cost of facility inspection requested by the County.

1.03 SHOP DRAWINGS AND SUBMITTALS

- A. Submittals shall be submitted to the County/Professional for review and acceptance prior to construction in accordance with the General Conditions and specifications Section 01300 "Submittals."
- B. Materials and Shop Drawings
- C. Manufacturer's Certification
 - 1. Submit sworn certification of factory tests and their results.

1.04 PRODUCT DELIVERY, STORAGE AND HANDLING

- A. Delivery and Storage: Delivery and storage of the materials shall be in accordance with the manufacturer's recommendations. PVC pipe shall be covered with black plastic with a minimum thickness of 15-mil. Joint gaskets shall be stored in a clean, dark and dry location until use.
- B. Handling: Care shall be taken in loading, transporting and unloading to prevent damage to the pipe or fittings and their respective coatings. Pipe or fittings shall not be rolled off the carrier or dropped. Pipe shall be unloaded by lifting with a forklift or crane. All pipe or fittings shall be examined before installation and no piece shall be installed which is found to be defective. Pipe shall be handled to prevent damage to the pipe or coating. Accidental damage to pipe or coating shall be repaired to the satisfaction of County or it shall be removed from the job. When not being handled, the pipe shall be supported on timber cradles or on level ground, graded to eliminate all rock points and to provide uniform support along the full pipe length. When being transported, the pipe shall be supported at all times in a manner to prevent distortion or damage to the lining or coating. Any unit of pipe that, in the opinion of the County, is damaged beyond repair by the Contractor shall be removed from the site.
- C. The Contractor shall be responsible for all materials furnished and stored until the date of project completion. The Contractor shall replace, at his expense, all materials found to be defective or damaged in handling or storage. The Contractor shall, if requested by the County, furnish certificates, affidavits of compliance, test reports, samples or check analysis for any of the materials specified herein. All pipe delivered to project site for installation is subject to random testing for compliance with the designated specifications.

PART 2 - PRODUCTS

2.01 GENERAL

- A. All material supplied shall be one of the products specified in Appendix D "List of Approved Products" appended to these technical specifications.

2.02 MATERIALS

A. Polyvinyl Chloride (PVC) Pipe

1. Standards: AWWA C900/C905 and ASTM D1784/D3034/F679 (Gravity Sewer)
2. Compounds: Class 12454-A or Class 12454-B
3. PVC Gravity Pipe and Fittings: PVC gravity pipe (6-inch to 15-inch), shall conform to ASTM D3034, maximum SDR 35. PVC gravity pipe (18-inch to 36-inch), shall conform to ASTM F679 and uniform minimum "pipe stiffness" at 5% (percent) deflection shall be 46-psi. The joints shall be integral bell elastomeric gasket joints manufactured in accordance with ASTM D3212 and ASTM F477. Applicable UNI Bell Plastic Pipe Association standard is UNI B.
4. PVC Pressure Pipe and Fittings: All PVC pipe of nominal diameter 4 to 12-inches shall be manufactured in accordance with AWWA Standard C900 and greater than 12-inches shall be manufactured in accordance with AWWA Standard C905. The PVC pipe shall have a minimum working pressure rating of 100-psi and shall have a maximum dimension ratio of 18. Pipe shall be the same outside diameter as ductile iron pipe.
5. Dimension Ratio/Thickness: (unless otherwise shown on the Drawings)
 - a. Raw Wastewater:
 - (1) Pressure Systems: DR 18
 - (2) Gravity Systems: DR 35 (ASTM D3034) or PS 46 (ASTM F679)
 - b. Treated Wastewater: DR 18
 - c. Reclaimed Water: DR 18
 - d. Raw Water: DR 18
 - e. Potable Water: DR 18
 - f. Irrigation Piping: Schedule 40 or SDR 21
6. Joints:
 - a. Push-on integral bell elastomeric gasket joints:
 - (1) Standards: ASTM D3212/D3139/F477 and UNI-B-1
 - (2) Gaskets:
 - (a) Potable and Reclaimed Water Service: Styrene Butadiene Rubber (SBR) ring type.
 - (b) Wastewater Service: Neoprene rubber ring type.
 - (3) Pipe Markings: Pipes shall have a manufacturer's home-mark on the spigot. On field cut pipe, the Contractor shall provide home-mark on the spigot in accordance with manufacturer's recommendations.
 - b. Solvent weld (nominal diameter less than 4-inches):
 - (1) Standards: ASTM D2466/D2564
 - (2) Type: Slip Fitting Socket (tapered)
 - (3) Exclusions: Plastic saddle and flange joints will not be used.
 - c. Restrained Joints:
 - (1) Restrained joint devices shall be made specifically for PVC pipe and meet or exceed the requirements in ASTM F-1674.
 - (2) Manufacturers: Uni-flange mechanical joint restraints and bell restraints (for all sizes); Meg-a-lug system as manufactured by EBBA Iron (sizes 12-inches or less), or acceptable equal.
 - (3) Design pressure rating equal to or above test pressure as specified herein.

- d. Pipe Length:
 - (1) Pressure systems: 20-feet maximum nominal length
 - (2) Gravity systems: 13-feet minimum nominal length
- B. Fittings - Pressure Systems (nominal diameter 4-inches and greater):
 - 1. Materials: Ductile iron
 - 2. Joints: Mechanical Joint, Minimum 350-psi pressure rating
 - 3. Gaskets:
 - a. Water and Reclaimed Water Service: Styrene Butadiene Rubber (SBR) ring type
 - b. Wastewater Service: Neoprene rubber ring type
 - 4. Exclusions: Standard double bell couplings will not be acceptable where the pipe will slip completely through the coupling.
 - 5. All fittings shall conform to either ANSI/AWWA C110/A21.10 and/or C153/A21.53, latest revision, and shall be ductile iron.
 - 6. All fittings shall have a date code cast (not printed or labeled), with identification of the date, factory and unit at which it was cast and machined. Fittings shall have distinctly cast on them the pressure rating, nominal diameter of openings, manufacturer's name, the country where cast, and deflection angle. Ductile iron fittings shall have the letters "DI" or "Ductile" cast on them.
 - 7. All potable water main fittings shall have NSF certification and ISO 9001 certification for both the foundry and manufacturer. The NSF 61 certification shall be issued on all coatings and linings, from the said manufacturers that are used for potable water applications.
 - 8. All ductile iron fittings shall have exterior coatings, including markings and colors, and interior linings in conformance with Section 15062 "Ductile Iron Pipe and Fittings."
- C. Fittings - Pressure Systems (nominal diameter less than 4-inches)
 - 1. Material: Polyvinyl Chloride (PVC)
 - 2. Joints: Slip fitting tapered socket with solvent weld
 - 3. Solvent: Sure Guard 12 or acceptable equal
 - 4. Exclusions: Plastic saddle and flange joint fittings shall not be used

2.03 LOCATION MARKERS, LOCATION WIRE AND IDENTIFICATION MARKINGS

- A. Electronic Markers and Locator System (for reclaimed water and wastewater ONLY)
 - 1. Markers: Markers shall consist of a passive device capable of reflecting a specifically designated repulse frequency tuned to the utility (service) being installed. Markers shall be color coded in accordance with the American Public Works Association's "Utility Locating and Coordinating Council Standards." Colors shall be: Wastewater and Reclaimed Water - #1404 Green. Markers shall be full range. Markers shall be installed directly above the centerline of the respective pipeline at intervals not to exceed 100-feet, at each fitting (tees, wyes, crosses, reducers, plugs, caps and bends) or change in horizontal direction and at each valve along the pipeline. Markers shall be hand backfilled to 1-foot above the pad and have a finished depth of burial of not less than 2-feet or more than 6-feet. No separate payment shall be made for furnishing and installing the respective frequency and color-coded electronic pad type marker.

2. Locator System: Marker locator set shall be the 3M Dynatel 1420 or 3M Dynatel 1420E Electronic Marker System Marker Locator, or acceptable equal. The Contractor shall furnish 1 locator set for each type of service piping installed on the Project (i.e.: reclaimed water, wastewater.) to the County. Each unit shall incorporate the following features and accessories:
 - a. Unit(s) shall be tuned to the proper frequency for each type (service) of piping.
 - b. Field strength meter that provides visual indication of the return signal
 - c. Function switch for selection of operation mode
 - d. Sensitivity control to adjust the receiver gain
 - e. Audio speaker for signal response
 - f. Battery access panel containing condensed operating instructions
 - g. Auxiliary headset and heads set jack
 - h. Permanently attached shoulder straps
 - i. Rugged shockproof and weatherproof storage/carrying case
3. Manufacturer: System shall be Scotch Mark Locator System, or acceptable equal.

B. Location Detection Wire

1. Materials: Continuous, insulated 10-gauge copper wire (color to match pipe identification).
2. Installation: Directly above (1-inch maximum) centerline of pipe terminating at top of each valve box collar and be capable of extending 18-inches above top of box (stored inside the 2-inch brass pipe through the valve box collar) in a manner so as not to interfere with valve operation. For direction drilling installations, a minimum of 2 (two) 10-gauge wires shall be pulled along with the pipe.

C. Identification Markings:

1. Pipe furnished in solid color or white with color lettering as indicated below.
 - a. Lettering along top 90° (degrees) of pipe, minimum 3/4-inch in height with appropriate wording appearing 1 or more times every 21-inches along the entire length of the pipeline.
 - (1) Raw Wastewater: Safety Green
 - (2) Reclaimed Water: Purple (Pantone 522C)
 - (3) Potable Water: Safety Blue

PART 3 - EXECUTION

3.01 INSTALLATION

- A. Standards: AWWA C900/C905/UNI-B 3 and 4
- B. Underground Polyvinyl Chloride (PVC) Pipe and Fittings
 1. Bedding: Firm, dry and even bearing of suitable material. Blocking under the pipe will not be permitted.
 2. Placement/Alignment:
 - a. Installation shall be in accordance with lines and grades shown on the Drawings. For pressure systems, deflection of joints shall not exceed 75% of that recommended by the manufacturer.

- b. All pipe and fittings shall be inspected prior to lowering into trench to insure no cracked, broken or otherwise defective materials are being used. All homing marks shall be checked for the proper length so as to not allow a separation or over homing of connected pipe. Homing marks incorrectly marked on pipe shall result in rejection of pipe and removal from site. The Contractor shall clean ends of pipe thoroughly and remove foreign matter and dirt from inside of pipe and keep clean during and after installation.
- c. Proper implements, tools and facilities shall be used for the safe and proper protection of the Work. Pipe shall be lowered into the trench in such a manner as to avoid any physical damage to the pipe. Pipe shall not be dropped or dumped into trenches under any circumstances.
- d. Trench Dewatering and Drainage Control: Contractor shall prevent water from entering trench during excavation and pipe laying operations to the extent required to properly grade the bottom of the trench and allow for proper compaction of the backfill. Pipe shall not be laid in water.
- e. Pipe Laying in Trench: Dirt or other foreign material shall be prevented from entering the pipe or pipe joint during handling or laying operations and any pipe or fitting that has been installed with dirt or foreign material in it shall be removed, cleaned and re-laid. Pigging of pipe may be used to remove foreign materials in lieu of flushing. At times when pipe installation is not in progress, the open ends of the pipe shall be closed by a watertight plug or by other means approved by the County to ensure absolute cleanliness inside the pipe. The color stripe and pipe text shall be viewed from the top of pipe when installed. When installing PVC pipe, no additional joints will be installed until the preceding pipe joint has been completed and the pipe carefully embedded and secured in place.
- f. Locating Wire: Locating wire, for electronically locating pipe after it is buried, or installed by trenchless technology shall be attached along the length of and installed with the pipe. This is applicable to all sizes and types of pressure mains. At a minimum, the tracing wire is to be attached to the pipe with nylon wire ties. The wire itself shall be 10-gauge single strand solid core copper wire with non-metallic insulation. The insulation shall be color coded for the type of pipe being installed. Continuous continuity must be maintained in the wire along the entire length of the pipe run. Permanent splices must be made in the length of the wire using wire connectors approved for underground applications as listed in the uniform electric code handbook. The coiled wire shall extend to a minimum of 12-inches above the surface and be connected to a test station box at valve locations.
- g. PVC Pressure Pipe Installation and Training: PVC pipe shall be installed in accordance with standards set forth in the UNI-BELL "Handbook of PVC Pipe", AWWA C605, and AWWA Manual M-23. The pipe shall be laid by inserting the spigot end into the bell flush with the insertion line or as recommended by the manufacturer. At no time shall the bell spigot end be allowed to go past the "insertion line" or "homing mark" for pressure pipe applications and homing mark shall be visible.

- h. Field Cutting: PVC pipe can be cut with a handsaw or power driven abrasive disc making a square cut. The end shall be beveled with a beveling tool, wood rasp or power sander to the same angle as provided on the factory-finished pipe. The insertion line on the spigot shall be remarked to the same dimensions as the factory-marked spigot.
- i. All Contractor pipe crews utilizing PVC pressure pipe shall be trained on an annual basis by Uni-Bell in coordination with the County and attended by the manufacturer's representative of the respective approved Manufacturers in Appendix D "List of Approved Products." The Uni-Bell PVC training session will consist of proper handling, storage, installation, and compaction as well as County requirements regarding PVC pipe and deflection. Every person handling, installing or backfilling PVC pipe shall not be permitted to install County owned and / or maintained pipe without training.
- j. Approved manufacturers representatives (Appendix D "List of Approved Products"), not present at the hosted Uni-Bell training session or individuals of pipe crews not in attendance shall be trained on every project site. On-site project training shall be for each manufacturer of pipe utilized on-site, per crew and per project. Specifically each crewmember shall be trained on every project by every pipe manufactures representative regardless of previous on-site training. Every person handling, installing or backfilling PVC pipe shall not be permitted to install County owned and / or maintained pipe without training.
- k. PVC Gravity Pipe Installation: Gravity sewer pipe shall be installed to the homing mark, no tolerance. Any noticeable separation shall be removed and reinstalled. The homing mark may be disregarded to meet the maximum of 1-inch separation between bell and spigot requirement. Joints:
 - l. Joint Placement:
 - (1) Push on joints: Pipe shall be laid with the bell ends facing upstream. The gasket shall be inserted and the joint surfaces cleaned and lubricated prior to placement of the pipe. After joining the pipe, a metal feeler shall be used to verify that the gasket is correctly located.
 - (2) Mechanical Joints: Pipe and fittings shall be installed in accordance with the "Notes on Method of Installation" under ANSI A21.11/AWWA C111. The gasket shall be inserted and the joint surfaces cleaned and lubricated with soapy water before tightening the bolts to the specified torque.

C. Thrust Restraint

- 1. Thrust restraint shall be accomplished by the use of mechanical restraining devices unless specifically identified otherwise on the Drawings or herein.
- 2. Length of restrained joints shall be in accordance with the lengths listed in the table as shown on the Drawings.

D. Installation of Pipes on Curves:

- 1. No joint deflection or pipe bending is allowed in PVC pipe. The maximum allowable tolerance in the joint due to variances in installation is 0.75° (degrees) (3-inches per joint per 20-foot stick of pipe). No bending tolerance in the pipe barrel shall be acceptable. Alignment change shall be made only with sleeves and fittings.

3.02 CLEANING AND FIELD TESTING

- A. At the conclusion of the Work, the Contractor shall provide all associated cleaning and field testing as specified in associated sections of these specifications.

END OF SECTION

SECTION 15065
STAINLESS STEEL PIPE AND FITTINGS

PART 1 - GENERAL

1.01 DESCRIPTION

- A. Scope: This section specifies stainless steel pipe and fittings.
- B. Types of Service: Stainless steel piping specified in this Section shall be used for raw sewage discharge piping in the pump station wetwell.

1.02 QUALITY ASSURANCE

- A. References: This Section contains references to the following documents. They are a part of this Section as specified and modified. Where a referenced document contains references to other standards, those documents are included as references under this Section as if referenced directly. In the event of conflict between the requirements of this Section and those of the listed documents, the requirements of this Section shall prevail.

Reference	Title
ANSI B16.1	Cast Iron Pipe Flanges and Flanged Fittings Classes 25, 125, 250, and 800
ANSI B16.11.80	Forged Steel Fittings, Socket Welding and Threaded
ANSI B31.1	Power Piping
ANSI B36.19M	Stainless Steel Pipe
ASME Section IX (1989)	Boiler and Pressure Vessel Code; Welding and Brazing Qualifications
ASTM A182/A182M	Forged or Rolled Alloy-Steel Pipe Flanges, Forged Fittings, and Valves and Parts for High Temperature Service
ASTM A193/A193M	Alloy-Steel and Stainless Steel Bolting Materials for High Temperature Service
ASTM A194/A194M	Carbon and Alloy Steel Nuts for Bolts for High Pressure and High Temperature Service
ASTM A240	Heat-Resisting Chromium and Chromium Nickel Stainless Steel Plate, Sheet, and Strip for Pressure Vessels
ASTM A276	Stainless and Heat-Resisting Steel Bars and Shapes
ASTM A312/A312M	Seamless and Welded Austenitic Stainless Steel Pipes
ASTM A320/A320M	Alloy Steel Bolting Materials for Low Temperature Service
ASTM A403/A403M	Wrought Austenitic Stainless Steel Piping Fittings
ASTM A409/A409M	Welded Large Diameter Austenitic Steel Pipe for Corrosive or High Temperature Service

ASTM A480/A480M	General Requirements for Flat-Rolled Stainless and Heat-Resisting Steel Plate, Sheet and Strip
ASTM A774/A774M	As-Welded Wrought Austenitic Stainless Steel Fittings for General Corrosive Service at Low and Moderate Temperatures
ASTM A778	Welded, Un-annealed Austenitic Stainless Steel Tubular Products

- B. Qualifications: All shop fabricated stainless steel pipe and fittings shall be furnished by a single manufacturer who is experienced and qualified in the manufacture and fabrication of the items to be furnished. The pipe and fittings shall be shop-fabricated and field-installed in accordance with common industry wide practices and methods and shall comply with these specifications. Only weld procedures which have been qualified under ASME Section IX and only welders who have successfully completed performance qualification tests per ASME Section IX on these qualified procedures shall be utilized.
- C. Testing: Factory testing shall conform to the requirements of ASTM A312, ASTM A409 HT-0, or ASTM A778, depending on the size and type of stainless steel pipe provided.

1.03 SHOP DRAWINGS AND SUBMITTALS

- A. Submittals shall be submitted to the County/Professional for review and acceptance prior to construction in accordance with the General Conditions and specifications Section 01300 "Submittals."
- B. Shop fabrication drawings showing details of materials, piping, fittings, couplings, dielectric connections, joint locations and details, and types and locations of supports.
- C. Certifications specified in the following documents:
 1. ASTM A403, paragraph 14.1
 2. ASTM A774, paragraph 14.1
 3. ASTM A778, paragraph 14.1
 4. ASTM A409, paragraph 17.1
- D. Test results as specified in this Section.
- E. Names and qualification records of proposed welders.
- F. Other data necessary to show conformance of the piping system to these specifications.

PART 2 - PRODUCTS

2.01 GENERAL

- A. All material supplied shall be one of the products specified in Appendix D "List of Approved Products" appended to these technical specifications.

2.02 PIPE

- A. Unless otherwise specified, stainless steel piping 3-inches and larger shall be manufactured from ASTM A240 annealed and pickled sheets and plates, Type 316L, in accordance with ASTM A778 or ASTM A409 HT-0. Only extra-low carbon (ELC) materials with 0.030% maximum carbon shall be used. Pipe shall be manufactured to nominal pipe sizes as listed in ANSI B36.19 and shall have nominal wall thickness corresponding to schedule 40S.

2.03 FITTINGS

- A. Unless otherwise specified, stainless steel fittings 3-inch and larger shall be butt weld type manufactured in accordance with ASTM A774 of the same material and in the same thicknesses as the pipe. Long radius elbows less than 24-inches in diameter shall be smooth flow. All short radius, special radius, reducing, and long radius elbows 24-inches and greater in diameter shall be of mitered construction. Reducers shall be straight tapered cone type. Tees, crosses, laterals, and wyes shall be shop-fabricated from pipe.

2.04 FLANGED CONNECTIONS

- A. Connections shall be flanged as specified in Section 15062 "Ductile Iron Pipe and Fittings" and be capable of being mated to ductile iron pipe flanges or pump base elbow.

2.05 GASKETS

- A. Gaskets shall be as specified in Section 15062 "Ductile Iron Pipe and Fittings."

2.06 BOLTS

- A. Bolts, nuts, and washers for stainless steel flange assemblies shall be Type 316 stainless steel with bolts and nuts conforming to ASTM A193 Grade B8M.

2.07 PIPE SUPPORT SYSTEMS

- A. Unless otherwise specified, all hangers, rods, structural attachments, and other components of support systems for stainless steel pipe shall be of the same materials as the pipe.

2.08 FINISH

- A. After all shop operations have been completed, pipe and fittings shall be pickled and passivated in the manufacturer's plant, and scrubbed and washed until discoloration and possible iron picked up from manufacturing process are removed. The standard finish for 16-gauge through 8-gauge material shall be No. 1 or 2B per ASTM A480; 3/16-inch and heavier plate material shall be No. 1-mil finish or better per ASTM A480.

PART 3 - EXECUTION

3.01 PIPE CUTTING, THREADING, AND JOINTING

- A. Pipe cutting, threading, and jointing shall conform to the requirements of ANSI B31.1. All pipe threads shall be lubricated with Teflon tape.

3.02 WELDING

- A. General: Piping with wall thickness up to 11-gauge (0.120-inch) shall be welded with the TIG (GTAW) process. Unless otherwise specified, heavier walls shall be properly beveled and have a root pass with the TIG (GTAW) process followed by subsequent passes with the TIG (GTAW), MIG (GMAW), or Metallic Arc (SMAW) process. Filler wire of ELC grades only shall be added to all welds to provide a cross section at the weld equal to or greater than the parent metal. Weld deposit shall be smooth and evenly distributed and have a crown of no more than 1/16-inch on the I.D. and 3/32-inch on the O.D. of the piping. Concavity, undercut, cracks, or crevices shall not be allowed. Butt welds shall have full penetration to the interior surface, and inert gas shielding shall be provided to the interior and exterior of the joint. Excessive weld deposits, slag, spatter, and projections shall be removed by grinding. Welds on gasket surfaces shall be ground smooth.
- B. Field Welding: Field welding shall be minimized to the greatest extent possible by prefabrication of pipe systems at the factory. Pipe butt welds may be performed at the job site providing the butt welds are performed only with an inert gas shielded process and that other applicable specified welding requirements are rigidly adhered to. All residue, oxide, and heat stain is to be removed from any type of field weld and the affected adjacent areas by the use of stainless steel wire brushes. The field weld shall then be cleaned with an agent such as Eutectic Company's "Eucleen" or equal followed by complete removal of the agent.
- C. Preparation of Surfaces to Be Welded: Surfaces of joints to be welded shall be free from mill scale, slag, grease, oil, paint, rust, and other foreign material. Joints to be welded shall be wire-brushed with stainless steel wire brushes and precisely fitted before welding.
- D. Weather Conditions: Welding shall be done only when the surfaces are completely free of any moisture. Welding of the pipe shall not be done during periods of high winds or rain unless the areas being welded are properly shielded.
- E. Tack Welds, Clips, and Other Attachments: Nicks, gouges, notches, and depressions in the base metal in the area of the joint shall be repaired before the joint weld is made. Tack welds, clips, and other attachments shall be removed and defects repaired, except where the tack welds occur within the weld area and these tack welds do not exceed the size of the completed weld. Cracked tack welds shall be removed. Areas to be repaired shall be ground to clean metal and then repaired by building up with weld metal. The repaired areas shall be ground smooth to form a plane surface with the base metal.

- F. Defects and Repairs: Welds with cracks, slag inclusions, porosity, undercutting, incomplete penetration, or which are otherwise deficient in quality or made contrary to any provisions of these specifications shall be removed by chipping or grinding throughout their depth to clean base metal. Calking or peening of welds to correct defects shall not be done. Welds found deficient in dimension but not in quality shall be enlarged by additional welding after thoroughly cleaning the surface of previously deposited metal and the adjoining plate. Weld deposits, slag, weld spatter, and projections into the interior of the pipe shall be removed by grinding.

3.03 MARKING, SHIPPING, AND STORAGE

- A. Pipe, fittings, and fabrications shall be properly marked with type, gauge, and heat number. Fabricated piping shall have openings plugged and flanges secured for storage or transport after fabrication. Fabricated piping shall be piece-marked with identifying numbers or codes which correspond to the Contractor's layout and installation drawings. The marks shall be located on the spools at opposite ends and 180° (degrees) apart. Pipe spools shall be loaded, blocked, and lagged as necessary to ensure protection from damage during shipping. Stainless steel pipe and fittings shall be stored per manufacturer's recommendation. Dents, gouges, and scratches in stainless steel pipe and fittings are not acceptable and are reason for rejecting pipe and fittings.

3.04 FABRICATION/INSTALLATION REQUIREMENTS

- A. The piping supplier and the Contractor shall use extreme care to avoid the contact of any ferrous materials with the stainless steel piping during manufacturing, fabricating, handling, and installation stages. All saws, drills, files, and wire brushes shall be used for stainless steel piping only. Pipe storage and fabrication racks shall be nonferrous, stainless steel, or rubber-lined. Nylon slings or straps shall be used for handling stainless steel piping. After installation, the Contractor shall wash and rinse all foreign matter from the piping surface. All welded joints shall be treated with a pickling solution, brushed with stainless steel wire brushes, and rinsed clean. If rusting of embedded iron occurs, the Contractor shall pickle the affected surface with Oakite Deoxidizer SS, or equal, scrub with stainless steel brushes, and rinse clean.

3.05 COATINGS

- A. Painting of the stainless steel pipe is not required.

END OF SECTION

THIS PAGE LEFT BLANK INTENTIONALLY

SECTION 15100
ANCILLARY EQUIPMENT

PART 1 - GENERAL

1.01 DESCRIPTION

- A. Scope of Work: Provide all valves and appurtenances, ready for operation, as shown on the Drawings and as specified herein.

1.02 QUALITY ASSURANCE

- A. All valves, appurtenances, and ancillary equipment shall be products of well-established reputable firms who are fully experienced, reputable and qualified in the manufacture of the particular equipment to be furnished. The equipment shall be designed, constructed, and installed in accordance with the best practices and methods and shall comply with these Specifications.

1.03 SHOP DRAWINGS AND SUBMITTALS

- A. Submittals shall be submitted to the County for review and acceptance prior to construction in accordance with the General Conditions and specifications Section 01300 "Submittals."

PART 2 - PRODUCTS

2.01 GENERAL

- A. All valves, appurtenances, and ancillary equipment shall be of the sizes shown on the Drawings and specified herein.
- B. All valves and appurtenances shall have the name of the maker and the working pressure for which they are designed cast in raised letters upon some appropriate part of the body.
- C. All valves, appurtenances, and ancillary equipment shall be as specified in Appendix D "List of Approved Products" appended to these technical specifications.

2.02 AIR RELEASE VALVES

- A. For Water Service and Reclaimed Water Service
 - 1. General: Water mains shall be equipped with combination air release valves located as shown on the Drawings. Valves shall be made to remove air at high points where elevation changes exceed 5-feet. Automatic air release valves shall be located at high points for pipe systems greater than 12-inches in diameter.

2. Water and Reclaimed Water Combination Air Release Valves: The valve body shall be 316 stainless steel, 316 stainless steel float, bronze water diffuser Buna-N or Viton seat and stainless steel trim.
3. Fittings from the main to the air release valve shall be threaded and made of brass.

B. For Wastewater Service

1. General: Wastewater force mains shall be equipped with combination air release valves located as shown on the Drawings. Valves shall be made to remove air at high points where elevation change is 2-feet or greater, located in an enclosure as detailed on the Drawings.
2. Wastewater Combination Air Release Valves: The valve body shall be conical in shape and shall be 316 stainless steel with a funnel shape lower body to automatically drain sewage back into the system. All internal parts shall be corrosion resistant 316 stainless steel or non-metallic plastic materials.
3. On flanged connections 316 stainless steel bolts, nuts and washers are to be used along with the proper sized gasket.

C. Air release valves shall be installed in an enclosure.

2.03 TAPPING SLEEVES AND VALVES

A. General: Tapping sleeves shall be mechanical joint sleeves.

B. Mechanical Joint Sleeves: Sleeves shall be cast of gray-iron or ductile-iron and have an outlet flange with the dimensions of the Class 125 flanges shown in ANSI B16.1 and properly recessed for tapping valve. Glands shall be gray-iron or ductile iron. Gaskets shall be vulcanized natural or synthetic rubber. Bolts and nuts shall comply with ANSI/AWWA C111/ANSI A21.11. Sleeves shall be capable of withstanding a 200-psi working pressure.

C. Fabricated Mechanical Joint Tapping Sleeves: Sleeves shall be of split mechanical joint design with separate end and side gaskets. Sleeves shall be fabricated of high strength steel, meeting ASTM A283 Grade C or ASTM A-36. Outlet flange shall meet AWWA C-207, Class "D" ANSI 150-pound drilling and be properly recessed for the tapping valve. Bolts and nuts shall be high strength low alloy steel to AWWA C111 (ANSI A21.11). Gasket shall be vulcanized natural or synthetic rubber. Sleeve shall have manufacturer applied fusion-bonded epoxy coating, minimum 12-mil thickness.

D. Tapping Valves: Tapping valves shall be resilient seated gate valves flange by mechanical joint ends. Valves shall be compatible with tapping sleeves as specified above and specifically designed for pressure connection operations.

1. Tapping valves with alignment lip shall be placed vertical where possible for Water and Reclaimed Water.

2. Tapping Valves 16-inch and larger shall be AWWA C515 resilient seated only (16-inch and 24-inch no gearing required) above 24-inch shall be installed vertically with a spur gear actuator. When tapping existing mains, valves 24-inch and above shall be furnished with NPT pipe plugs for flushing the tracks.

2.04 VALVE BOXES FOR BURIED VALVES

- A. Standard 2-piece Cast Iron Valve Box: Required for mains less than 6-feet below finished grade and less than or equal to 12-inches in diameter.
 1. Valve boxes shall be provided with suitable heavy bonnets and shall extend to such elevation at or slightly above the finished grade surface as directed by the County's Representative.
 2. The barrel shall be 2-piece, screw type only, having 5-1/4-inch shaft. The upper section shall have a flange at the bottom having sufficient bearing area to prevent settling and shall be complete with locking cast iron covers. Coat buried cast iron pieces with coal tar epoxy.
- B. Valve Box Assembly: Valve box assemblies with operating nut extension is required for any size main that is 6-feet or greater below finished grade or if mains are greater than 12-inches in diameter.
 1. Valve boxes shall be 1 complete assembled unit composed of the valve box and extension stem that attaches and locks to the 2-inch wrench nut. The extension shall be high strength, corrosion resistant steel construction, and permanently attached to the operating nut.
 2. The operating nut extension insert shall be 1 complete assembled unit with a self-adjusting extension stem system that fits inside a standard valve box that will accommodate variable trench depths 6-feet and greater as shown in the Drawings. All moving parts of the extension stem shall be enclosed in a housing to prevent contact with the soil.
 3. A valve box-centering device designed to eliminate the shifting of the valve box against the operating nut of the valve shall be used. Valve box assembly shall be adjustable to accommodate variable trench depths 6-foot and greater as shown in the Drawings.
- C. The stem assembly shall be of a telescoping design that allows for variable adjustment length. The material shall be at minimum galvanized square steel tubing. The stem assembly shall have a built-in device that prevents the stem assembly from disengaging at its fully extended length. The extension stem must be capable of surviving a torque test to 1,000-foot-pounds without failure.
- D. Valve boxes shall have locking cast iron covers utilizing a 5-sided nut with a special wrench needed to open. Covers shall have "WATER", "SEWER", or "RECLAIMED WATER" cast into the top, as applicable
- E. Concrete Collar: Each valve installed in an unimproved area (outside of pavement, driveways or sidewalks) shall require a 24-inch by 24-inch by 6-inch concrete pad or collar as shown in the Drawings.

- F. Identification Disc: Each 16-inch or larger valve (unless otherwise shown on the Drawings) installed shall be identified by a 3-inch diameter bronze disc anchored in the concrete pad or collar in unimproved areas and/or anchored on a 4-inch by 4-inch by 18-inch long concrete post set flush with the pavement surface in improved areas. The disc shall be stamped with the following information as shown on the Drawings:
 - 1. Size of the valve
 - 2. Type of valve
 - 3. Service
 - 4. Direction and number of turns to open
- G. Valve markers are to be made of schedule 80 PVC and have decal applied containing information as shown on the Drawings. The marker shall be the same color as the pipe being marked.

2.05 LINE STOPPING ASSEMBLIES

- A. Sleeves used to line-stop existing mains shall be provided and installed at locations as shown on the Drawings. Line-stopping sleeve shall be steel fusion epoxy coated body with stainless steel straps, bolts, nuts, and washers. Contractor shall determine the outside diameter of the existing main prior to ordering sleeve.
- B. The line-stopping equipment shall consist of a resilient sealing element, which shall be attached to and transported by a plug inserter perpendicularly into the pipe. The linear actuator shall extend and retract the Line-Stopper into and out of the pipe. When retracted from the pipe, the element and inserter shall be contained within the stopper housing.
- C. The hollow cylindrical sealing element shall be molded of natural rubber. The lower interior chamber of the element shall be enlarged into a hemispherical cavity to allow symmetrical deformation into sealing conformity with the bore of the pipe.
- D. The linear actuator shall be hydraulic and shall have a self-contained hand operated pump. The actuator shall exert a force sufficient to perpendicularly deform the cylindrical element into axially symmetrical sealing contact with the bore of the pipe. Design of actuator shall provide adequate stroke and means to continually align the line-stop bullet stopping assemblies in sizes 14-inch through 20-inch with pressure rating to 250-psig.
- E. Equalization of pressure across the sealed element shall not be required to retract the element from the pipe. No equalization fittings shall be required downstream of the line-stopper.
- F. The line-stopping equipment shall be accurately aligned on the 4-inch through 8-inch fittings by locating in the external threads of the fitting nozzle. With sizes 10-inch and 12-inch the location shall be made on the centering groove of the fitting flange.
- G. Line-stopping equipment must be capable of function and acceptance of multiple stopper heads and shall be compatible with existing system fittings.

2.06 FIRE HYDRANTS AND VALVE ASSEMBLIES

- A. Fire hydrants shall be 5-1/4-inch minimum valve opening and shall comply with the current AWWA Standard Specifications C502-54 for 150-psi working pressure. Fire hydrants shall be of ample length for 3-1/2-foot depth of bury with necessary extensions to place safety flange the required 3-inches above finished grade. Each hydrant shall be made in at least 2 sections bolted together. All interior working parts of the hydrant shall be removable from the top of the hydrant to allow repairs without removing the hydrant barrel after it has been installed. It shall be provided with 2 (two) 2-1/2-inch hose nozzles and 1 (one) 4-1/2-inch pumper nozzle, all having its specific Fire District Standard hose threads. All nozzles shall have caps attached by chains. Operating nuts shall be AWWA Standard. Drain or weep holes shall be permanently plugged by the manufacturer.
- B. Fire hydrant painting and coating shall meet the requirements of Section 09900 "Painting." Fire hydrants shall be painted silver in accordance with the present Orange County standards. Three (3) operating wrenches shall be furnished for every 10 hydrants installed or relocated.
- C. All hydrant assemblies shall incorporate anchoring hydrant fittings, including M.J. Locked Hydrant Tee with split gland to provide the locking together of the entire assembly. Gate valve shall be as specified in Specification Section 15111 "Plug Valves."
- D. All hydrants shall have a 24-inch to 48-inch square by 6-inch thick reinforced concrete shear pad as shown in the Drawings.
- E. Fire hydrants shall be located in the general location as shown on the Drawings. Final field location of all hydrants shall be as approved by the County. All hydrants shall be located no less than 5 and no more than 10-feet from the edge of pavement of the adjacent roadway and no less than 5-feet from any physical feature which may obstruct access or view of any hydrant unless otherwise approved by the County.

2.07 SERVICE SADDLES

- A. Stainless Steel Service Saddles: Shall be epoxy or nylon coated ductile iron body with stainless steel, 18-8 type 304 straps, AWWA tapered threads for 1-inch and 2-inch to be iron pipe threads. Controlled OD saddles to be used on C905 PVC pipe, double straps to be 2-inch minimum width each, single strap to be minimum of 3-inches wide.
- B. PVC Pipe Service Saddle
 1. One-inch and 2-inch services utilize brass body saddle with controlled OD for 12-inches and smaller pipe.
 2. One-inch and 2-inch taps on existing pipes larger than 12-inches shall use controlled OD epoxy or nylon coated ductile iron body with stainless steel 18-8 type 304 straps.
 3. Four-inch or larger services shall be mechanical tapping sleeves.
- C. Ductile Iron Pipe Service Saddle
 1. One-inch services shall be direct tapped.

2. Two-inch service shall use a controlled OD service tapping saddle with stainless steel straps and a ductile iron body that is either nylon or epoxy coated
3. Four-inch or larger services shall be mechanical tapping sleeves.

D. HDPE Pipe Service Saddle

1. One-inch and 2-inch shall utilize controlled O.D. tapping saddle with epoxy or nylon coated stainless steel 18-8 type 304 double straps.
2. Four-inch or larger, shall use wide body tapping sleeves with a broad cross section gasket set in a retaining groove that increases sealing capability as pressure increases.

E. Concrete Pressure Pipe Service Saddle

1. Tapped concrete pressure pipe shall be in accordance with AWWA M-9, using a strap-type saddle made specifically for concrete cylinder pressure pipe.

F. Steel Pipe Service Saddle

1. Welded-on steel sleeves shall be used for all sizes and applications.

2.08 CORPORATION STOPS AND CURB STOPS

- A. Corporation Stops: Shall be brass body reduced port type compatible with the polyethylene tubing and threaded in accordance with AWWA C800, AWWA C901, and shall comply with NSF-61.
- B. Curb Stops: Shall be brass body reduced port type compatible with the polyethylene tubing and threaded in accordance with AWWA C800, AWWA C901, and shall comply with NSF-61.

2.09 WATER MAIN AND RECLAIMED WATER MAIN SERVICE PIPE

- A. Polyethylene Service Pipe: One-inch and 2-inch service lines shall be polyethylene tubing conforming to AWWA C901 and AWWA C800. Tubing shall be approved for potable water use and bear the seal of the National Sanitation Foundation (NSF). The product shall be rated for a minimum working pressure of 150-psi and a (Dimension Ratio) DR-9 size. The tubing shall be designated copper tube size and the material PE-2406 cell classification minimum PE213323C in accordance with ASTM 3350.
- B. Ductile Iron Service Pipe: Services 4-inch and larger shall be DIP. If the existing main is on the same side of the street as the property to be serviced, the service pipe shall be DIP from the point of connection to the existing main to the meter assembly. If the existing main is on the opposite side of the street as the property to be serviced, at a minimum, the segment of pipe immediately upstream from the meter assembly shall be DIP.
- C. No service pipe shall terminate under a driveway.

2.10 PRESSURE GAUGES

- A. Pressure gauges shall be installed on each pump station discharge pipe as indicated on the Drawings.
- B. Pressure gauge shall be direct mounted, diaphragm (type) gauge, stainless steel case, stainless steel sensing element, liquid filled, with a 4-1/2-inch diameter dial and furnished with a clear glass crystal window and 1/4-inch shut-off (isolation) valve. Gauges shall be weatherproof.
- C. The pressure gauge face dial shall be white finished aluminum with jet-black graduations and figures and shall indicate the units of pressure measured in psi. Gauges shall be provided with pressure at normal operation at the mid range of the gauge.
- D. As wastewater flows through the housing, the cylinder shall transmit pressure through the sensing liquid. Gauge outlet in the spool or ring shall be threaded, 1/4-inch, per ANSI B2.1.
- E. Nipples for connecting gauges to piping shall be Schedule 80S, Grade TP 316 seamless stainless steel, conforming to ASTM A 312. Fittings shall conform to ASTM A 403, Class WP316. Threads shall conform to ANSI B2.1. Size of pipe nipple shall match the gauge connection size.

2.11 TIE RODS

- A. Steel for tie rods and tie bolts shall conform to the requirements of ASTM Designation A 242, and rods shall be galvanized in conformance with requirements of ASTM Designation A 123.

2.12 BACK FLOW PREVENTION

- A. Reduced Pressure Backflow Preventer shall conform to the requirements of ASSE 1013, rated to 180°F and supplied with full port ball valves. The main body and access covers shall be bronze and meet ASTM B 584, the seat ring and all internal polymers shall be NSF Noryl and the seat disc elastomers shall be silicone.
- B. Dual check valves shall be required and shall be accessible for maintenance without removing the relief valve or the entire device from the line.
- C. The bottom of the preventer shall be installed a minimum of 12-inches above grade and not more than 30-inches above grade.

2.13 FLANGED COUPLING ADAPTERS

- A. All adapters shall be harnessed with the bolts across the joint (flange to flange or flange to lug) designed for the pipe test pressure.

- B. Adapter Size: Conform in size and bolt hole placement to ANSI standards for steel and/or cast iron flanges 125 or 150-pound standard unless otherwise required for connections.
- C. Exposed Sleeve Type
 - 1. Material: Steel
 - 2. Coating: Enamel
 - 3. Bolting: Carbon steel
 - 4. Acceptable Manufacturers: Dresser Manufacturing Co. - Style 128 for cast iron ductile iron and steel pipes with diameters of 2-inches through 96-inches, or equal.
- D. Buried Sleeve Type
 - 1. Material: Cast iron
 - 2. Bolting: Type 304 stainless steel conforming to ASTM A 193, Grade B8 for bolts, and ATM A 194, Grade 8 for nuts and washers. Bolts and nuts greater than 1-1/8-inches shall be carbon steel, ASTM A 307, Grade B, with cadmium plating, ASTM A 165, Type NS.
 - 3. Acceptable manufacturers: Dresser Manufacturing Co. - Style 127 locking type for cast iron, ductile, iron, asbestos cement and steel pipes with diameters of 3-inches through 12-inches, or equal.
- E. Split Type
 - 1. Material: Malleable or ductile iron.
 - 2. Design: For use with grooved or shouldered end pipe.
 - 3. Coating: Enamel
 - 4. Acceptable Manufacturers: Victaulic Company of America - Style 741 for pipe diameters of 2-inches through 12-inches, Victaulic Company of America - Style 742 for pipe diameters of 14-inches through 16-inches, or equal.

PART 3 - EXECUTION

3.01 INSTALLATION

- A. All ancillary equipment shall be installed in the locations shown, true to alignment and rigidly supported. Any damage to the above items shall be repaired to the satisfaction of the County before installation.
- B. After installation, all ancillary equipment shall be tested as specified for adjacent piping. If any joint or equipment proves to be defective, it shall be repaired and retested to the satisfaction of the County.
- C. Install all floor boxes, brackets, extension rods, guides, the various types of operators and appurtenances as shown on the Drawings that are in masonry floors or walls, and install concrete inserts for hangers and supports as soon as forms are erected and before concrete is poured. Before setting these items, the Contractor shall check all plans and figures, which have a direct bearing on the location and shall be responsible for the proper location of these valves and appurtenances during the Construction of the structures.

D. Notification and Connections to Existing Mains

1. The Contractor shall submit a completed "System Connection" form to the County to schedule the connection. The request shall be made a minimum of 5-working days prior to the proposed tie-in to the existing main for pressure connections and 10-working days prior to the proposed tie-in to the existing main for non-pressure connections. In this request, the Contractor shall provide the following information:
 - a. Points of connection, fittings to be used and method of flushing and disinfection if applicable
 - b. Estimated construction time for said connections
 - c. Identify pressure and non-pressure connections
2. Connections shall only be made on the agreed upon date and time. If the Contractor does not perform the Work in the agreed upon manner or schedule, the Contractor shall be required to reschedule the connection by following the procedure outlined above.

E. Pressure Connections: Sufficient length of main shall be exposed to allow for installation of the tapping sleeve and valve and the operation of the tapping machinery. The main shall be supported on concrete pedestals or bedding rock at sufficient intervals to properly carry its own weight, plus the weight of the tapping sleeve, valve and machinery. Any damage to the main due to improper or insufficient supports will be repaired at the Contractor's expense.

1. Prior to the tap, the Contractor shall assemble all materials, tools, equipment, labor, and supervision necessary to make the connection.
2. The Contractor shall excavate a dry and safe working area pit of sufficient size to enable the necessary Work.
3. The inside of the tapping sleeve and valve, the outside of the main and the tapping machine shall be cleaned and swabbed or sprayed with 1% liquid chlorine solution prior to beginning installation for water system pressure connections and must comply with AWWA C-651-99 or most current version.
4. After the tapping sleeve has been mounted on the main, the tapping valve shall be bolted to the outlet flange, making a pressure tight connection. Prior to beginning the tapping operation, the sleeve and valve shall be pressure tested under the observation of County personnel to 150-psi for 30-minute duration to ensure that no leakage will occur.
5. For pressure connections 4-inch through 20-inch installation, the minimum diameter cut shall be 1/2-inch less than the nominal diameter of the pipe to be attached. For larger taps, the allowable minimum diameter shall be 2 to 3-inches less than the nominal diameter of the pipe being attached. After the tapping procedure is complete, the Contractor shall submit the coupon to the County.
6. The tapping valve shall be placed horizontally for pressure connections to wastewater force mains. A plug valve shall be attached to the tapping valve after the tapping procedure is complete. The tapping valve shall be left in the open position prior to backfilling.
7. Adequate restrained joint fittings shall be provided to prevent movement of the installation when test pressure is applied.
8. The Contractor shall be responsible for properly backfilling the work area pit after the Work is completed.

F. Non-Pressure Dry Connections

1. For water service connections, no customer shall be without service for more than 6-hours. For wastewater connections, provide bypass operations per Section 01516 "Collection System Bypass." This accommodation to customers may include scheduling after Normal Working Hours.
2. The Contractor shall be ready to proceed by pre-assembling as much material as possible at the site to minimize the length of service interruption.
3. Needed pipe restraints must be installed prior to the initiation of the shutdown.
4. The excavation shall be opened and needed site preparations must be completed before the initiation of the connection work.
5. County shall postpone a service cut-off if the Contractor is not ready to proceed at the scheduled time.
6. Only County personnel shall operate the valves needed to perform the shutdown on the existing system.

3.02 PAINTING

- A. All exterior surfaces of iron body valves shall be clean, dry, and free from rust and grease before coating.
- B. For valves installed underground or in valve vaults, all exterior ferrous parts of valve and actuator shall be coated at the factory with a thermally bonded epoxy coating in accordance with AWWA C550, latest revision.
- C. For aboveground service, the exterior ferrous parts of all valves shall be coated in weatherproof paint. The color of the finish coats shall be in accordance with the Orange County Utilities Standards.

END OF SECTION

SECTION 15105
CHECK VALVES

PART 1 - GENERAL

1.01 SCOPE OF WORK

- A. Scope of Work: Furnish, install, and test check valves including all appurtenances required as shown on the Drawings and as specified herein.
- B. General Design
 1. Valves larger than 2-1/2-inch diameter shall meet or exceed the requirements of AWWA C-508.
 2. All of the equipment and materials specified herein are intended to be standard for use in controlling the flow of sewage, water, sludge, chemicals, air, etc., depending on the applications.
 3. All valves and appurtenances shall have the name of the manufacturer and the working pressure for which they are designed cast in raised letters upon some appropriate part of the body.
 4. For all buried valves in which the operating nut is deeper than 4-feet from the finish ground surface, an extension rod with 2-inch operating nut and upper guide shall be installed permanently in the riser section. Extend nut to 1-foot below finish grade.

1.02 QUALITY ASSURANCE

- A. All gate valves of same type and style shall be manufactured by one manufacturer.
- B. All equipment furnished under this Specification shall be new and unused and shall be a standard product which has a successful record of reliable service in similar installations for a minimum of 5-years.

1.03 SHOP DRAWINGS AND SUBMITTALS

- A. Submittals shall be submitted to the County/Professional for review and acceptance prior to construction in accordance with the General Conditions and specifications Section 01300 "Submittals."
- B. Shop Drawings and submittals shall be submitted to the County/Professional Engineer for review and acceptance prior to construction for the following:
 1. Certified Shop Drawings showing details of construction, dimensions (including laying length), and weight.
 2. Descriptive literature, bulletins, and/or catalogs showing all valve parts and describing material of construction by material and specification, e.g., AISI.
 3. Valve coatings and linings, if any.
 4. A complete bill of materials for all equipment.

1.04 PRODUCT DELIVERY, STORAGE, AND HANDLING

A. Shipping

1. All parts shall be properly protected so that no damage or deterioration will occur during a prolonged delay from the time of shipment until installation is completed.
2. Factory assembled parts and components shall be dismantled for shipment unless permission is received in writing from the County/Professional Engineer.
3. Finished surfaces of all exposed openings shall be protected by wooden blanks, strongly built and securely bolted thereto.
4. Finished iron or steel surfaces not painted shall be properly protected to prevent rust and corrosion.
5. After hydrostatic or other tests, all entrapped water shall be drained prior to shipment, and proper care shall be taken to protect parts from the entrance of water during shipment, storage, and handling.
6. Each box or package shall be properly marked to show its net weight in addition to its contents.

B. Storage

1. Store valves and accessories in an area on the construction site protected from weather, moisture, or possible damage.
2. Do not store valves or accessories directly on the ground.

C. Handling

1. Handle valves and accessories to prevent damage of any nature.
2. Carefully inspect all materials for:
 - a. Defects in workmanship and materials
 - b. Removal of debris and foreign material in valve openings and seats
 - c. Proper functioning of all operating mechanisms
 - d. Tightness of all nuts and bolts

1.05 WARRANTY AND GUARANTEES

- A. The manufacturer's warranty period shall be concurrent with the Contractor's for 1-year, unless otherwise specified, commencing at the time of final acceptance by the County.
- B. The Contractor shall be responsible for obtaining certificates for equipment warranty for all equipment which lists for more than \$500.00 (major equipment). The County reserves the right to request warranties for equipment not classified as "major". The Contractor shall still warrant equipment not considered to be "major" in the Contractor's 1-year warranty period even though certificates of warranty may not be required.
- C. In the event that the equipment manufacturer or supplier is unwilling to provide a 1-year warranty commencing at the date of substantial completion, the Contractor shall obtain from the manufacturer a 2-year warranty commencing at the time of equipment delivery to the job site. This 2-year warranty from the manufacturer shall not relieve the Contractor of the 1-year warranty starting at the time of County acceptance of the equipment.

- D. The County shall incur no labor or equipment cost during the guarantee period.
- E. Guarantee shall cover all necessary labor, equipment, and replacement parts resulting from faulty or inadequate design, improper assembly or erection, defective workmanship and materials, leakage, breakage, or other failure of equipment or components furnished by the manufacturer.

PART 2 - PRODUCTS

2.01 MATERIALS AND EQUIPMENT

- A. Ball Check Valves, 2-1/2-inches and smaller.
 - 1. Valves shall be all bronze construction with screwed ends.
 - 2. Minimum valve working pressure shall be 150-psi.
 - 3. Valves shall be as manufactured by Crane, Watts, or equal.
- B. Rubber Flapper Swing Check Valves (Sewage/Sludge and Low Pressure Effluent Pumping Application; i.e., less than 50-psi).
 - 1. Valves shall have a cast iron body and cover meeting ASTM A126, Class B specifications.
 - 2. Flapper shall be Buna-N reinforced and shall be easily removed without any need to remove the valve from line.
 - 3. Ends shall be flanged, 125-pound ANSI B16.1. The flapper shall be Buna-N having an "O" ring seating edge and be internally reinforced with steel.
 - 4. Valve shall provide drip-tight shutoff.
 - 5. Each check valve shall be provided with an NEMA 4X limit switch mounted on the horizontal centerline of the body seat.
 - 6. Provide a manually operated backflow device which shall positively lock open flapper during full backflow.
 - 7. The FLEX portion of the disc shall have a 20-year warranty.
 - 8. Valves shall be manufactured by Apco Valve and Primer Corp., Series 100, Val-Matic Valve and Manufacturing Corp., Swing Flex, or equal.
- C. Swing Check Valves
 - 1. Swing check valves shall conform to AWWA C508.
 - 2. The valve body shall be 2-piece cast iron conforming to ASTM A126 with flanged ends conforming to ANSI B16.1. The area throughout the valve body shall be equal to the full pipe area.
 - 3. The valve disc shall be ductile iron with bronze or resilient seating face. The disc shall be partially balanced with a short travel to resist slamming.
 - 4. The seat ring and disc ring shall be ASTM B763 Alloy 84400 bronze, with beveled edges, firmly clamped or screwed into the valve body. Seat rings and disc rings shall be field replaceable.
 - 5. The hinge pin shall be of stainless steel with bronze bushings, allow free movement of the disc without binding, and shall be guaranteed not to stick in the closed position.
 - 6. The valve shall be designed for a minimum working pressure of 150-psi.
 - 7. Valves shall be supplied with an outside lever and adjustable weight.

8. Valves 4-inches and larger shall be 8-mil epoxy lined.

D. Cushioned Swing Check Valves (Potable Water and High Pressure Effluent Application greater than 50-psi).

1. All materials shall be as follows:

Table 15105-1
Materials of Construction

PART	MATERIAL	ASTM or SAE
Body, Cover, Disc	Cast Iron	A 126 GR.B
Disc Arm	Ductile Iron	A 536
Seat	Aluminum bronze or Stainless Steel	B 148 A 276
Seat Ring	Buna-N rubber or Metal	
Hinge Shaft	Stainless Steel	Type 303

2. Valve body shall have integral flanges.
3. The seat shall be centrifugally cast bronze with an o-ring seal and be locked in place with stainless steel lock screws and be field replaceable without the use of special tools.
4. The shaft shall be single and continuous stainless steel, extending both sides of the body with a lever and weight, using a side-mounted air cushion cylinder.
5. The air cushion cylinder shall be constructed of corrosion resistant material and the piston shall be totally enclosed. The cylinder assembly shall be externally mounted to the valve body and will permit adjustability to cushion the closure of the check valve.
6. The valve shall prevent backflow of water on normal pump shut-off or power failure and shall be watertight.
7. A valve position indicator and micro switch shall be provided to remotely indicate open/close position of check valve.
8. Valve body area shall equal or exceed the full pipe area.
9. Valve shall be Series 6,000 air cushioned swing check valve as manufactured by APCO or acceptable equal.

PART 3 - EXECUTION

3.01 INSTALLATION

- A. Install valves and accessories in strict accordance with manufacturer's instructions and recommendations, as shown on the Drawings and/or as directed by the Owner.
- B. Carefully erect all valves and support them in their respective positions free from distortion and strain.

- C. Bolt holes of flanged valves shall straddle the horizontal and vertical centerlines of the pipe run to which the valves are attached. Clean flanges by wire brushing before installing flanged valves. Clean flange bolts and nuts by wire brushing, lubricate threads with oil and graphite, and tighten nuts uniformly and progressively. Clean threaded joints by wire brushing or swabbing. Apply Teflon joint compound or Teflon tape to pipe threads before installing threaded valves. Joints shall be watertight.
- D. Support all valves connected to pumps and equipment, and in piping systems that cannot support valves.
- E. Repair any scratches, marks and other types of surface damages, etc., with original prime coating as supplied by the factory.
- F. Apply finish coating in accordance with Division 9.

3.02 DEMONSTRATION AND TESTING

- A. Demonstration, start-up (adjustment) and testing shall demonstrate that all valves have been properly installed and that check valves operate properly.

END OF SECTION

THIS PAGE LEFT BLANK INTENTIONALLY

SECTION 15110
PLUG VALVES

PART 1 - GENERAL

1.01 DESCRIPTION

Wastewater force mains shall have plug valves installed as shown on the Drawings. This Section specifies plug valves, manual actuators and associated valve boxes.

1.02 QUALITY ASSURANCE

A. References

Reference	Title
ANSI B16.1	Cast Iron Pipe Flanges and Flanged Fittings Class 25, 125, 250, and 800
ASTM A126	Gray Iron Castings for Valves, Flanges, and Pipe Fittings
ASTM A276	Stainless and Heat-Resisting Steel Bars and Shapes
ASTM A436	Austenitic Gray Iron Castings
ASTM A536	Ductile Iron Castings
AWWA C504	Rubber Seated Butterfly Valves

B. Proof-of-Design Tests

The Contractor shall furnish the County three (3) certified copies of a report from an independent testing laboratory certifying successful completion of proof-of-design testing conducted in accordance with AWWA C504, Section 5.2, except that where the word "disc" appears in the standard, it is understood to mean "plug." In lieu of testing the valves at an independent testing laboratory, proof-of-design testing may be performed at the valve manufacturer's laboratory, but must be witnessed by a representative of a qualified independent testing laboratory, and all test reports must be certified by the laboratory representative. Proof-of-design testing shall have been performed on at least 3 (three) 6-inch diameter valves, with all 3 (three) test units demonstrating full compliance with the test standards. Failure to satisfactorily complete the test shall be deemed sufficient evidence to reject all valves of the proposed make or manufacturer's model number.

1.03 SHOP DRAWINGS AND SUBMITTALS

A. Submittals shall be submitted to the County/Professional for review and acceptance prior to construction in accordance with the General Conditions and specifications Section 01300 "Submittals."

- B. **PRODUCT DATA:** The following information shall be provided in accordance with 1.03 of Section 01300 "Submittals."
1. Manufacturer's product data
 2. Proof-of-design test reports specified in paragraph 1.02 B

PART 2 - PRODUCTS

2.01 GENERAL

- A. All material supplied shall be one of the products specified in Appendix D "List of Approved Products" appended to these technical specifications.

2.02 MANUFACTURERS

Plug valves meeting the requirements of this Section shall be supplied from the approved manufacturers as listed in Appendix D "List of Approved Products."

2.03 MATERIALS

Materials of construction shall be as follows:

Component	Material
Body	Cast iron, ASTM A126, Class B
Plug	Cast iron, ASTM A126, Class B, or cast iron ASTM A436 (Ni-resist), or ductile iron, ASTM A536
Plug facing	Neoprene
Body seats	
3-inches and larger	Nickel
Packing	Buna V-flex or TFE

2.04 MANUFACTURE

- A. **Plug Valves:** Valves shall be straight-flow non-lubricated resilient plug type suitable for drip tight, bi-directional shutoff at the specified valve design pressure.
1. Plug valves shall be eccentric, ball centric or full port. All valves shall open counter-clockwise.
 2. All buried valves shall be fitted with valve boxes as specified in Paragraph 2.03.B of this Section. One 2-inch square tee-handled valve wrench, made by the valve manufacturer, of suitable length to operate all valves within valve boxes shall be furnished for every 5 valves installed.
 3. Plug valves shall be installed complete with extension stems, buried gear actuators, and 2-inch operating nuts (buried) or operating hand wheels (exposed), as required for normal operation. All valve nuts shall be brought up to 1-foot below the proposed finish grade.

4. Valves shall have the name of the manufacturer and the size of the valve cast or molded onto the valve body. A permanent plate shall be attached to the valve or operator indicating serial number, order number, accessories, operator model and manufacturer.
5. Ball centric/eccentric plug valves shall be of the non-lubricated type. The port area for valves 4-inches to 20-inches shall have a minimum 80% nominal pipe diameter and valves 24-inches and larger shall have a minimum port area of 70% of nominal pipe diameter unless noted on the Drawings as "full port". Plug valves denoted as full port shall have a port area equal to the full area of the nominal pipe diameter.
6. Minimum pressure rating of valves 4-inches to 12-inches shall be 175-psi; valves 14-inches to 72-inches shall be 150-psi. Valve bodies shall be cast iron ASTM A126, Class B and fusion-bonded epoxy coated.
7. Valve ends shall be mechanical joint (buried) or flanged (exposed) as indicated on the Drawings. Valve flange drilling for valves 3-inches and larger shall be per ANSI B16.1, Class 125. Plugs shall be cast iron or ductile iron with neoprene facing and shall be of the single piece design. The plug shall be of the same configuration for all valves and shall require no stiffening member opposite the plug for balance or support. Valve body seats shall have a welded-in overlay of not less than 90% nickel. Packing shall be adjustable and safely replaceable without disassembling the valve. Bushing shall be 316 stainless steel in both upper and lower journals and shall be protected from foreign matter with the use of a grit seal or similar. The valve should be capable of drip tight shut off with flow in either direction at the full pressure of the valve. All exposed nuts, bolts, springs and washers on buried service valves shall be 304 stainless steel. All above-grade valves shall have 316 stainless steel hardware.
8. Actuators: Manual valves shall have lever or gear actuators and tee wrenches, extension stems, and floor stands as indicated on the Drawings. Valves 6-inch and larger shall be equipped with buried service rated gear actuators. Buried valves shall have a 2-inch square operating nut. All gearing shall be enclosed in a steel housing and be suitable for running in a lubricant with seals provided on all shafts to prevent entry of dirt and water into the actuator. Actuator shafts shall be supported on permanently lubricated bronze bearings. Actuators shall clearly indicate valve position and an adjustable stop shall be provided to set closing torque. Exposed nuts, bolts and washers shall be 316 stainless steel. Valve packing adjustment shall be accessible without disassembly of the actuator.
9. Valve Testing: Plug valves shall be tested in accordance with AWWA C504. Each valve shall meet the performance, leakage, and hydrostatic tests described in AWWA C504. The leakage test shall be applied to the face of the plug tending to unseat the valve. The manufacturer shall furnish certified copies of reports covering proof-of-design testing as described in AWWA C504.

B. Valve Boxes

1. All valves installed underground shall have cast iron 2-piece valve boxes. Valve boxes shall be provided with suitable heavy bonnets and shall extend to such elevation at or slightly above the finished grade surface as directed by the County. The barrel shall be screw type only, with a 5-1/4-inch shaft. The upper section shall have a flange at the bottom having sufficient bearing area to prevent settling and shall be complete with locking cast iron covers. Covers shall have "SEWER" cast into the top for all wastewater mains which shall be so constructed as to prevent tipping or rattling.

2. A valve box with an operating nut extension is required for any size main that is 6-feet or greater below finished grade. The extension shall be high strength, corrosion resistant steel construction and permanently attached to the operating nut. The operating nut extension insert shall be one complete assembled unit with a self-adjusting extension stem system that fits inside a standard valve box. All moving parts of the extension stem shall be enclosed in a housing to prevent contact with the soil. A valve box-centering device designed to eliminate the shifting of the valve box against the operating nut of the valve shall be used. The valve box assembly shall be adjustable to accommodate variable trench depths 6-foot and greater as shown in the Drawings.
3. The stem assembly shall be of a telescoping design that allows for variable adjustment length. The material shall be galvanized square steel tubing. The stem assembly shall have a built-in device that prevents the stem assembly from disengaging at its fully extended length. The extension stem must be capable of surviving a torque test to 1,000 foot-pounds without failure.
4. The valve boxes shall have locking lids.
5. Extension sections shall be cast or ductile iron only.
6. Valve boxes in non-paved areas shall be installed with a valve collar as shown in the Drawings. The protective concrete collar with a bronze identification disc shall be constructed of Class B concrete as shown on the Drawings.

PART 3 - EXECUTION

3.01 INSTALLING VALVES AND BOXES

- A. Valves: Valves shall be carefully inspected, opened wide and then tightly closed and the various nuts and bolts shall be tested for tightness. Plug valves shall have the plug shaft installed horizontally with the plug rotating upward to the top of the valve. Any valve that does not operate correctly shall be removed and replaced. Seats shall face in the direction as recommended by the manufacturer.
- B. Valve Boxes: Valve boxes and risers shall be carefully centered over the operating nuts of the valves so as to permit a valve key to be fitted easily to the operating nut. In unpaved areas, valve boxes shall be set to conform to the level of the finished surface and held in position by a concrete collar placed under the support flange as shown on the Drawings. The valve box shall not transmit surface loads to the pipe or valve. Extensions or risers for valve boxes shall be an integral part of the box. No cut sections of ductile iron or PVC pipe shall be used in extending the box to its proper height. Care shall be taken to prevent earth and other material from entering the valve box. Any valve box which is out of alignment or whose top does not conform to the finished ground surface shall be dug out and reset. Before final acceptance of the Work all valve boxes shall be adjusted to finish grade.

END OF SECTION

SECTION 16010
ELECTRICAL GENERAL PROVISIONS

PART 1 - GENERAL

1.01 WORK INCLUDED

- A. The Work covered under this Division of the Specifications is intended to include the furnishing of all materials, equipment and labor necessary for or reasonably incidental to, the installation of a complete and fully operative electrical system as indicated on the Drawings and specified in this Section.
1. The Work shall consist generally of, but is not limited to, the following major items:
 - a. Circuit Protective Devices
 - b. Conduit and Wiring
 - c. Equipment Connections
 - d. Temporary power
- B. Work Not Included: The following work is not included in this Section:
1. Furnishing of pump control panels.
- C. Fees and Permits
1. Obtain all permits required for the Work and include the cost of same in bid.
 2. The Contractor shall also include in the bid, the cost for the power company service.
- D. Certificate of Inspection

The Contractor shall pay for a final inspection made of the complete electrical installation and shall deliver a certificate of approval of the complete Work to the County before receiving final payment.

E. Service

Voltage and Phase as indicated on the Drawings. Secondary metered electrical power underground or overhead as indicated on the Drawings. Serving electrical utility company is as noted on the Drawings.

1.02 SHOP DRAWINGS AND SUBMITTALS

- A. Submittals shall be submitted to the County for review and acceptance prior to construction in accordance with the General Conditions and specifications Section 01300 "Submittals."
- B. Submit to the County as provided in the General Conditions, Shop Drawings, manufacturer's literature and technical data on the proposed electrical systems before commencing work.

C. Shop Drawings

1. Submit copies of manufacturer's drawing of surge protection devices, circuit protective devices, panel boards, conduit, wire, wiring devices, and any other special electrical equipment to be installed, and shall receive the County's acceptance before ordering the same for installation.
2. All Shop Drawings shall be submitted in a 3-ring binder with each specification section indicated with tabs.
3. If Shop Drawings are submitted intermittently and not in 3-ring binders, they will not be reviewed and they will be returned to the Contractor for proper submittal.
4. Acceptable Equivalent
 - a. Any manufacturer and/or catalog number listed on the Drawings or in the Project Manual shall be construed to mean "or acceptable equivalent" as listed in Appendix D "List of Approved Products."
 - b. Any substitutions to be considered as "Acceptable Equivalent" shall be submitted with both the cut of the proposed substitution and a cut of the specified equipment to the County in writing, and returned to the Contractor at least 10-days prior to bid opening.
 - c. No substitutions shall be submitted or will be allowed after the contract has been awarded.

1.03 QUALITY ASSURANCE

A. Qualifications of manufacturers, materials and equipment

1. Material and equipment, except as herein otherwise noted, shall be new and conform to standards specified herein defined to include conduits, cable, wiring materials and devices and panel boards.
2. Materials and equipment shall be of an approved design.
 - a. Similar materials shall be of one manufacturer wherever possible.
3. Equipment offered under these Specifications shall be limited to products regularly produced and recommended for service ratings in accordance with manufacturer's catalogs, engineering data, or other comprehensive literature made available to the public and in effect at the time of opening of bids.
4. Install equipment in strict accordance with manufacturer's instruction for type, capacity and suitability of each piece of equipment used.
 - a. Obtain these instructions, which shall be considered a part of these Specifications.

B. Qualifications of supervisor, workmanship and installers

1. The Contractor shall have a Master Electrician constantly supervising the Work covered by these Specifications, and so far as possible shall keep the same foreman on the job from start to finish.
 - a. The workmanship of the entire job shall be excellent and only experienced and competent workers shall be employed for the Work.

1.04 CODES AND REGULATIONS

- A. Work shall be installed in accordance with the regulations and requirements of the National Electrical Code NFPA No. 70; Life Safety Code NFPA No. 101, Standard Building Code as well as all rules, state and local codes, regulations and requirements of the telephone and power companies.
- B. Where conduits and/or cables penetrate wetwell walls, the penetrations shall be sealed in accordance with NFPA 70, Article 500.
 - 1. The above shall be ascertained and fully coordinated before the installation of any material, equipment, and the like, and any discrepancy shall be immediately brought to the attention of the County in writing, and the Contractor shall receive a disposition of same before proceeding with the Work.
 - 2. Furnish, without additional charge, any additional materials and labor that may be required for compliance with these codes, law, rules, regulations or requirements even though the work is not mentioned in these Specifications or shown on the Drawings.
- C. Material and equipment shall bear the label of approval of the National Board of Fire Underwriters Laboratory.

1.05 INSPECTIONS

- A. All work and materials covered by these Specifications and shown on the Drawings shall be subject to inspection at any and all times by the County.
- B. If the County finds that any material does not conform with these Specifications, the Contractor shall within 3-days after being notified by the County; remove the material from the premises, and if said material has been installed, the entire expense of removing and replacing same, including any cutting and patching that may be necessary, shall be borne by the Contractor.
- C. Tests

The County reserves the right to inspect and test any portion of the equipment during the progress of this Work.

- 1. The Contractor shall test the entire system in the presence of the County when the Work is completed to insure that all portions are free from short circuits and grounds.
- 2. All equipment, material and labor necessary to conduct the above tests shall be furnished at the Electrical Contractor's expense.

1.06 PRODUCT HANDLING

- A. Protection of Equipment, Material and Work: The Contractor shall effectively protect and pay for protection of the work, materials or equipment, as is liable to injury during the construction period.
 - 1. Openings into any part of the conduit system as well as associated fixtures, equipment, and the like, both before and after being set in place, shall be securely covered or otherwise protected to prevent obstruction of the conduit, or injury due to carelessness or maliciously dropped tools or materials, grit, dirt, or any foreign matter.
 - a. The Contractor will be held responsible for all damage done until the Work is fully and finally accepted.
 - 2. Cover conduit ends with capped bushings.
- B. Repair of damage: In the event of damage, repair shall be made immediately, to the County's satisfaction and at no additional cost to the County.
- C. Special Handling: Special care, storage and handling of new and existing lighting fixtures shall be taken to minimize breakage of lenses and lamps shipped with fixtures.
 - 1. Immediately replace any breakage with the exact lens or lamp.

1.07 JOB CONDITIONS

- A. Accuracy of Data: The data given herein and on the Drawings are as exact as could be secured.
 - 1. The Specifications and Drawings are for the assistance and guidance of the Contractor.
 - 2. Exact locations, distances, levels, and the like, will be governed by the building field conditions and the Contractor shall use the data contained herein with this understanding.
- B. Drawings
 - 1. The electrical drawings are diagrammatic, but shall be followed as closely as actual construction and work of other Contractors will permit.
 - 2. Deviations from diagrammatic electrical drawings required by either building construction or the work of other Contractors shall be made by the Contractor at his/her expense.
 - 3. It is not the intention of the Drawings or specifications to indicate each piece of conduit and fittings required for the satisfactory operation of the installation and whereby one is indicated, but not specified, or specified but not indicated on the Drawings, it shall be considered to be both specified and indicated.
- C. Measurements
 - 1. Review the Contract Drawings and Specifications and visit the job site to ascertain all conditions, including conduit runs, interfacing, interferences, conflicts, discrepancies, etc., and shall report the same to the County for clarification 10-days prior to submittal of the bid.

2. Failure to comply with this condition shall constitute an acceptance of the conditions and any necessary changes will be at Contractor's expense.
3. The Contractor shall make all measurements necessary for his/her work and shall assume responsibility for their accuracy.
4. Install necessary pull boxes, manholes and junction boxes as may be required to accomplish the distribution system indicated on the riser diagram.

D. Structural difficulties: Should any structural difficulties prevent the setting of cabinets, running conductors, and the like, at points indicated on the Drawings, the necessary deviation will be as determined by the County shall be made without additional cost.

E. Cooperation with Other Contractors

1. The Contractor shall arrange all parts of his/her work in proper relation to the work of other Contractors.
2. Where interferences occur, the Contractor shall, before installing the work involved, consult with the County as to exact location and level of his/her work.
3. The County's decision will be final.
4. The Contractor shall be responsible for arrangement of his/her work and equipment and maintenance of proper headroom under this Work.
5. Should work installed under this Section require any modifications to avoid interference with the other work, such changes shall be made without additional cost.
6. The County's decision as to determination or allocation or responsibility where conditions require changing of work, shall be final.
7. If any work of the Contractor is dependent for its proper execution on contiguous work, examine such work and report in writing any defect thereon or conditions rendering it unsuitable.
8. The beginning of work, without making such report, shall constitute an acceptance of such work, and any defects in his/her own work consequently shall be his/her responsibility.

1.08 TEMPORARY SERVICE

- A. Temporary power: Provide, maintain and remove after construction is completed, a temporary, receptacle and power system in accordance with the progress schedule.
 1. Receptacles: Ground fault interrupter type.
 2. Three Phase Power for Testing Motors: Provided at all necessary points.
- B. Temporary telephone service: Each respective trade shall be responsible for providing and maintaining their telephone services.

1.09 CLEANING

- A. Keep the premises free of debris and unusable materials resulting from the Work, and immediately upon completion of the Work remove such debris and material from the site and leave floors broom clean in areas affected by the Work.

1.10 GUARANTEE

- A. Leave the electrical installation in proper working order and without charge, replace any work or materials which develop defects within 1-year from date of final inspection and acceptance by the County.

1.11 DEFINITIONS

- A. In this Division "provide" is used as a term contraction meaning "to furnish, install and connect up completely in the specified or in an approved manner for the item and/or material described."

PART 2 - PRODUCTS (NOT USED)

PART 3 - EXECUTION (NOT USED)

END OF SECTION

SECTION 16110

RACEWAYS

PART 1 - GENERAL

1.01 RELATED DOCUMENTS

- A. Drawings and general provisions of Contract, including General and Supplementary Conditions and Division 1 Specification sections, apply to work of this Section.

1.02 DESCRIPTION OF WORK

- A. Extent of raceway work is indicated by drawings and schedules.
- B. Types of raceway specified in this Section include the following:
 - 1. Liquid tight flexible metal conduit
 - 2. Rigid non-metallic conduit (PVC)
 - 3. Rigid aluminum conduit
- C. Electrical non-metallic tubing (ENT) is not acceptable.

1.03 QUALITY ASSURANCE

- A. Manufacturers: Firms shall have sufficient experience that will allow for quality and successful manufacture of raceway systems of types and sizes required for this Project.
- B. Installer's Qualifications: Firms shall have sufficient experience to allow for quality and successful installation of electrical raceway work required for this Project.

1.04 CODES AND STANDARDS

- A. NEMA Compliance: Comply with applicable requirements of NEMA Standards Publications pertaining to raceways.
- B. UL Compliance and Labeling: Comply with applicable requirements of UL safety standards pertaining to electrical raceway systems. Provide raceway products and components which have been UL listed and labeled.
- C. NEC Compliance: Comply with applicable requirements of NFPA-70 pertaining to construction and installation of raceway systems.
- D. Comply with NECA "Standard of Installation."
- E. Coordinate layout and installation of raceway and boxes with other construction elements to ensure adequate headroom, working clearance, and access.

1.05 SHOP DRAWINGS AND SUBMITTALS

- A. Submittals shall be submitted to the County for review and acceptance prior to construction in accordance with the General Conditions and specifications Section 01300 "Submittals."
- B. Product Data: Submit manufacturer's technical product data, including specifications and installation instructions for each type of raceway system required. Include data substantiating that materials comply with requirements.
- C. A copy of this specification section, with addendum updates included, and all referenced and applicable sections, with addendum updates included, with each paragraph check-marked to indicate specification compliance or marked to indicate requested deviations from specification requirements. Check marks shall denote full compliance with a paragraph as a whole.
- D. If deviations from the specifications are indicated, and therefore requested by the Contractor, each deviation shall be underlined and denoted by a number in the margin to the right of the identified paragraph, referenced to a detailed written explanation of the reasons for requesting the deviation.
- E. The County shall be the final authority for determining acceptability of requested deviations. The remaining portions of the paragraph not underlined will signify compliance on the part of the Contractor with the specifications.
- F. Failure to include a copy of the marked-up specification sections, along with justification(s) for any requested deviations to the specification requirements, with the submittal shall be sufficient cause for rejection of the entire submittal with no further consideration.

PART 2 - PRODUCTS

2.01 GENERAL

- A. All material supplied shall be one of the products specified in Appendix D "List of Approved Products" appended to these technical specifications.

2.02 NON-METALLIC CONDUIT

- A. General: Provide non-metallic conduit and fittings of types, sizes, and weights for each service indicated. Where types and grades are not indicated, provide proper selection determined by Installer to fulfill wiring requirements, which comply with provisions of NFPA-70 for raceway.

B. Electrical Plastic Conduit

1. Extra Heavy Wall Conduit: Schedule 80, UL rated, construct of polyvinyl chloride compound C 200 PVC, and UL listed in accordance with NFPA-70 Article 347 for direct burial, or above ground use. Conduits shall be UL listed and marked for use with conductors having 90°C insulation. Use conduits, couplings, bushings, elbows, nipples, and other fittings meeting the requirements of NEMA TC 2 and TC 3, Federal Specification W C 1094, UL, NEC, and ASTM specified tests for the intended use. Use only conduit with a factory formed bell on 1 end. Conduit that requires the use of couplings for straight runs will not be acceptable. Minimum size 3/4-inch exposed, 1-inch embedded or buried.

- C. Conduit and Tubing Accessories: Provide conduit and accessories of types, sizes, and materials, complying with manufacturers published product information, which mate and match conduit.

- D. Conduit Bodies: Provide extra heavy PVC conduit bodies of types, shapes and sizes as required to fulfill job requirements and NFPA-70 requirements. Construct conduit bodies with threaded conduit entrance ends, removable covers, either cast or of galvanized steel and corrosion resistant screws.

- E. Available Manufacturers: Subject to compliance with requirements, manufacturers offering conduit bodies which may be incorporated in the Work include, but are not limited to the following:

1. Appleton Electric; Div. of Emerson Electric Co.
2. Arrow Hart Div.; Crouse Hinds Co.
3. Bell Electric Div.; Square D Co.
4. Killark Electric Mfg. Co.
5. O Z/Gedney Div.; General Signal Co.
6. Spring City Electrical Mfg. Co.

2.03 RIGID ALUMINUM CONDUIT

- A. Meet requirements of ANSI C80.1 and UL6.

- B. Material: Type 6063, copper free aluminum alloy.

- C. Available Manufacturers

1. Appleton Electric, Div. Of Emerson Electric Co.
2. Arrow Hart Div; Crouse Hinds Co.
3. Bell Electric Div.; Square D Co.
4. O-Z/Gedney Div.; General Signal Co.

- D. Minimum size shall be 3/4-inch unless noted otherwise or permitted by the following: 1/2-inch may be used for connections to individual instruments, outlets, wiring devices and indoor lighting fixtures.

2.04 LIQUIDTIGHT FLEXIBLE METAL CONDUIT AND FITTINGS

- A. Liquid-tight Flexible Steel Conduit (LFS): UL listed liquid tight consisting of an extruded thermoplastic cover over a galvanized steel core. Minimum size 3/4-inch unless for equipment with 1/2-inch knockout.
- B. Fittings and Conduit Bodies: NEMA FB-1; galvanized steel compression type with O-ring.

PART 3 - EXECUTION

3.01 INSTALLATION

- A. General: Install raceways as indicated; in accordance with manufacturer's written installation instructions, and in compliance with NFPA-70, and NECA's "Standards of Installation."
- B. Coordinate with other work including wires/cables, boxes and panel work, as necessary to interface installation of electrical raceways and components with other work.
- C. Install conduits concealed below grade or in slabs. Where conduits turn up and/or cannot be concealed, route conduits exposed.
- D. Mechanically fasten together conduits, enclosures and raceways for conductors to form continuous system. Connect to electrical boxes, fittings and cabinets to provide firm mechanical assembly.
- E. Avoid use of dissimilar metals throughout system to eliminate possibility of electrolysis. Where dissimilar metals are in contact, coat surfaces with corrosion inhibiting compound before assembling.
- F. Cap conduits or plug flush conduits during construction to prevent entrance of dirt, trash, and water. Cap or plug empty conduits designated as "future", "spare", or "empty" and include a pulling line accessible at both ends. Use anti-seize compound on cap and plug threads prior to installation.
- G. Protect stub-ups from damage where conduits rise through floor slabs. Arrange so curved portion of bends is not visible above the finished slab.
- H. Make bends and offsets so the inside diameter is not reduced. Unless otherwise indicated, keep the legs of a bend in the same plane and the straight legs of offset parallel.
- I. Use raceway fittings compatible with raceway and suitable for use and location. Fitting sizes shall be such that the enclosed conductors do not exceed the permissible percentage of fitting area/volume.

- J. Install miscellaneous fittings such as reducers, chase nipples, 3-piece unions, split couplings, and plugs that have been specifically designed and manufactured for their particular application. Install expansion fittings in raceways every 200-foot linear run or wherever structural expansion joints are crossed.
- K. Use roughing in dimensions of electrically operated unit furnished by supplier. Set conduit and boxes for connection to units only after receiving review of dimensions and after checking location with other trades.
- L. Provide nylon pull cord in all empty conduits. Test conduits required to be installed, but left empty; test with ball mandrel. Clear any conduit, which rejects ball mandrel. Pay costs involved for restoration of conduit and surrounding surfaces to original condition.

3.02 CONDUIT INSTALLATION

- A. Use Schedule 80 PVC throughout above grade and for turn ups including elbows and bends and where required.
- B. Use rigid aluminum above grade between control panel and conduit seals.
- C. Cut conduits straight and properly ream.
- D. Field bend conduit with benders designed for purpose so as not to distort nor vary internal diameter.
 - 1. Size conduits to meet NFPA-70, except no conduit smaller than 3/4-inches shall be embedded in concrete or installed below grade.
 - 2. Fasten conduit terminations in sheet metal enclosures by threaded hubs, and terminate with insulating bushings.
 - 3. Complete installation of electrical raceways before starting installation of cables/wires within raceway.

3.03 CONCEALED CONDUITS

- A. Install coupling full depth to ensure watertight integrity.
- B. Install underground conduits minimum of 24-inches below finished grade.

3.04 CONDUITS IN CONCRETE SLAB

- A. Place conduits between bottom reinforcing steel and top reinforcing steel.
- B. Place conduits either parallel, or at 90° (degrees) to main reinforcing steel.
- C. Separate conduits by not less than diameter of largest conduit to ensure proper concrete bond.
- D. Conduits crossing in slab must be reviewed for proper cover by the County.

E. Embedded conduit diameter is not to exceed 1/3 (one-third) of slab thickness.

F. Install conduits as not to damage or run through structural members.

3.05 NON METALLIC CONDUITS

A. Make solvent cemented joints in accordance with recommendations of manufacturer.

B. Install PVC conduits in accordance with NFPA-70 and in compliance with local practices.

3.06 CONDUIT FITTINGS

A. Construct locknuts for securing conduit to metal enclosure with sharp edge for digging into metal, and ridged outside circumference for proper fastening.

B. Install insulated type bushings for terminating conduits. Bushings shall have cast flared bottom and ribbed sides. Upper edge to have phenolic insulating ring molded into bushing. Bushings shall be "O.Z" type or "B" or equal.

C. Bushings shall have screw type grounding terminal.

D. Miscellaneous fittings such as reducers, chase nipples, 3-piece unions, and plugs to be specifically designed for their particular application.

END OF SECTION

SECTION 16120
WIRES AND CABLES

PART 1 - GENERAL

1.01 RELATED DOCUMENTS

- A. Drawings and general provisions of Contract, including General and Supplementary Conditions and Division 1 Specifications sections, apply to work of this Section.
- B. Work described in this Section includes furnishing all labor, materials, equipment, tools and incidentals required for a complete and operable installation of all electrical conductors, wire and cables and associated splices, connectors, and termination for wiring systems rated 600 volts or less. All electrical conductors shall be installed, adjusted, tested and placed in operation in accordance with these Specifications, the manufacturer's recommendations and as shown on the Drawings.

1.02 DESCRIPTION OF WORK

- A. Extent of electrical wires and cable work is indicated by drawings and schedules.
- B. Types of electrical wire, cable, and connectors specified in this Section include the following:
 - 1. Copper conductors
 - 2. 2 and/or 4 bolt connectors
 - 3. Wire nut connectors
- C. Applications of electrical wire, cable, and connectors required for project are as follows:
 - 1. For power distribution circuits
 - 2. For control and equipment circuits
 - 3. For motor branch circuits

1.03 QUALITY ASSURANCE

- A. Manufacturers: Firms shall have sufficient experience that will allow for quality and successful manufacture of electrical wire and cable products of types, sizes and ratings required for items required for this Project.
- B. Installer's Qualifications: In addition to the requirements specified in Division 16 an independent testing firm shall meet OSHA criteria for accreditation of testing laboratories, Title 29, Part 1907 quality and successful installation of wire and cable products for this Project.
- C. NFPA-70 Compliance: Comply with NFPA-70 requirements as applicable to construction, installation and color-coding of electrical wires and cables.

- D. UL Compliance: Comply with applicable requirements of UL Std. 83, "Thermoplastic Insulated Wires and Cables" and Std. 486A, "Wire Connectors and Soldering for Use With Copper Conductors".
- E. UL Compliance: Provide wiring/cabling and connector products, which are UL, listed and labeled.
- F. NEMA/ICEA Compliance: Comply with NEMA/ICEA Std. Pub/No's WC5, Thermoplastic Insulated Wires and Cable for the "Transmission and Distribution of Electrical Energy", and WC30, "Color Coding of Wires and Cables", pertaining to electrical power type wires and cables.
- G. IEEE Compliance: Comply with applicable requirements of IEEE Standards 82, "Test Procedures for Impulse Voltage Tests on Insulated Conductors", and Standard. 241, "IEEE Recommended Practice for Electric Power Systems in Commercial Buildings" pertaining to wiring.
- H. ASTM Compliance: Comply with applicable requirements of ASTM B1, 2, 3, 8, and D-573. Provide copper conductors with conductivity of not less than 98% at 20°C (68°F.)
- I. FOIST Compliance: Comply with Federal Specifications J C 30, "Electrical Cable and Wire (Power, Fixed, Installation)", and W-S-610, "Splice Conductor."
- J. Listing and Labeling: Provide products specified in this Section that are listed and labeled.
 - 1. The Terms "Listed" and "Labeled": As defined in the "National Electrical Code", Article 100.
 - 2. Listing and Labeling Agency Qualifications: A "Nationally Recognized Testing Laboratory" (NTRL) as defined in OSHA Regulation 1910.7.

1.04 SHOP DRAWINGS AND SUBMITTALS

- A. Submittals shall be submitted to the County/Professional for review and acceptance prior to construction in accordance with the General Conditions and specifications Section 01300 "Submittals."
- B. Product Data: Submit manufacturer's data on electrical wires, cables, and conductors.
- C. A copy of this specification section, with addendum updates included, and all referenced and applicable sections, with addendum updates included, with each paragraph check-marked to indicate specification compliance or marked to indicate requested deviations from specification requirements. Check marks shall denote full compliance with a paragraph as a whole.
- D. If deviations from the specifications are indicated, and therefore requested by the Contractor, each deviation shall be underlined and denoted by a number in the margin to the right of the identified paragraph, referenced to a detailed written explanation of the reasons for requesting the deviation.

- E. The County shall be the final authority for determining acceptability of requested deviations. The remaining portions of the paragraph not underlined will signify compliance on the part of the Contractor with the specifications.
- F. Failure to include a copy of the marked-up specification sections, along with justification(s) for any requested deviations to the specification requirements, with the submittal shall be sufficient cause for rejection of the entire submittal with no further consideration.

1.05 DELIVERY, STORAGE, AND HANDLING

- A. Deliver wire and cable properly packaged in factory-fabricated type containers, or wound on NEMA specified type wire and cable reels.
- B. Store wire and cable in clean dry space in original containers. Protect products from weather, damaging fumes, construction debris and traffic.
- C. Handle wire and cable carefully to avoid abrasing, puncturing, and tearing wire and cable insulation and sheathing. Ensure that dielectric resistance integrity of wires/cables is maintained.

PART 2 - PRODUCTS

2.01 GENERAL

- A. All material supplied shall be one of the products specified in Appendix D "List of Approved Products" appended to these technical specifications.

2.02 ACCEPTABLE MANUFACTURERS

- A. Available Manufacturers: Subject to compliance with requirements, manufacturers offering products which may be incorporated in the Work include, but are not limited to the following:
 - 1. Wire and Cable
 - a. Alpha Wire Corporation
 - b. Apex Wire and Cable Corp.
 - c. American Insulated Wire Corp.
 - d. American Wire and Cable Co.
 - e. Anaconda-Ericson Inc., Wire and Cable Div.
 - f. Beldon Div.; Cooper Industries
 - g. Brand-Rex Div.; Pyle National Co.
 - h. Cablec
 - i. Cerro Wire and Cable Corp.
 - j. Cleveland Insulated Wire Co.
 - k. Dekoron
 - l. Konite
 - m. Penn

- n. Pirelli
 - o. Phelps Dodge Cable and Wire Co.
 - p. Rome Cable Corp.
 - q. Southwire Corp.
 - r. Triangle PWC, Inc.
2. Connectors
- a. AMP, Inc.
 - b. Anderson
 - c. Appleton Electric Co.; Emerson Electric Co.
 - d. Burndy Corporation
 - e. Brand-Rex Div.; Pyle National Co.
 - f. Electrical Products Div.; Midland Ross Corp.
 - g. General Electric Co.
 - h. Ideal Industries, Inc.
 - i. 3M Company
 - j. Monograms Co.
 - k. O-Z/Gedney Co.
 - l. Pyrotenax
 - m. Southport Industries Inc.
 - n. Square D Company
 - o. Thomas and Betts Corp.

2.03 WIRES, CABLES, AND CONNECTORS

- A. General: Provide electrical wires, cables, and connectors of manufacturer's standard materials, as indicated by published product information; designed and constructed as recommended by manufacturer, for a complete installation, and for application indicated. Except as otherwise indicated, provide copper conductors with conductivity of not less than 98% at 20°C (68°F.)
- B. Building Materials: Provide factory-fabricated wires of sizes, ampacity ratings, and materials for applications and services indicated. Where not indicated, provide proper wire selection as determined by installer to comply with project's installation requirements, NFPA-70 and NEMA standards. Select from the following UL types, those wires with construction features, which fulfill project requirements.
1. Type THW/THHN/ THWN, dual rated: For dry or wet locations; maximum operating temperature 75°C (167°F.) Insulation, flame retardant, moisture and heat resistant, thermoplastic; outer covering, nylon jacket; conductor, annealed copper. NEMA WC-5 thermoplastic insulated building wire. 98% conductivity copper, 600V PVC insulated with nylon jacket, 75/90 wiring type. Minimum size #12 AWG. For control circuits minimum size #14 AWG.
 2. Type XHHW: For dry and wet locations; maximum operating temperature 90°C (194°F.) Insulation, flame retardant, cross-linked synthetic polymer; conductor, annealed copper.

3. Type 1 (600 Volt Multi-Conductor Control Conductor Cable, Type TC)
 - a. General: Multi conductor control circuit interconnection cable with ground. Suitable for installation in open air, in cable trays, conduit or other approved raceways. Minimum cable temperature rating 90°C dry locations, 75°C wet locations. Passes vertical tray flame test.
 - b. Individual Conductors: No. 14 AWG, 7-strand copper.
 - c. Insulation and Jackets: Provide conductors having 15-mil PVC insulation with 4-mil nylon jacket, and UL listed as Type THHN/THWN.

2.04 CABLES FOR VARIABLE FREQUENCY MOTORS

- A. General: All AC motors rated 600 volt (maximum) which are powered from AC Variable Frequency Drives (VFDs), so as to permit variable speed operation, shall be wired with shielded multiconductor Variable Frequency Drive Cable, specifically manufactured for that application in exposed applications. When in conduit, 600V THHN/THWN copper wire is acceptable
- B. Conform to NEC Article 336.
- C. Ratings
 1. 1,000 Volt UL flexible motor supply cable
 2. XLPE insulated, XHHW-2 90°C Wet/Dry
- D. Suitable for Class 1, Div. 2 hazardous locations.
- E. Suitable for direct burial, cable tray installation and conduit installation.
- F. Full-sized ground wire or equivalent.
- G. Overall shield with full-sized drain wire or equivalent.
- H. Belden Part No. 295XX, or approved equal.

2.05 TYPE 2 (600 VOLT NO. 16 AWG TWISTED, SHIELDED PAIR INSTRUMENTATION CABLE, TYPE TC)

- A. General: Single pair instrumentation cable designed for noise rejection for process control, computer, or data log applications. Suitable for installation in cable trays, conduit, or other approved raceways. Minimum cable temperature rating shall be 90°C dry locations, 75°C wet locations.
- B. Individual Conductors: Bare soft annealed copper, Class B, 7-strand concentric per ASTM B 8; 20 AWG, 7-strand tinned copper drain wire.
- C. Insulation and Jacket: Each conductor 15-mil nominal PVC and 4-mil nylon insulation. Pair conductors pigmented black and red. Jacket flame-retardant and sunlight and oil resistant PVC with 45-mil nominal thickness. Shield 1.35-mil aluminum/mylar overlapped to provide 100% coverage.

D. Dimension: 0.31-inch nominal OD.

2.06 TYPE 3 (600 VOLT NO. 16 AWG, MULTIPLE TWISTED SHIELDED PAIRS WITH A COMMON OVERALL SHIELD INSTRUMENTATION CABLE, TYPE TC)

A. General: Twisted, shielded pairs of instrument cables, grouped in a single cable, designed for use as instrumentation, process control, and computer cable. Suitable for installation in cable tray, conduit or other approved raceways. Minimum cable temperature rating shall be 90°C dry locations, 75°C wet locations.

B. Conductors: Bare soft annealed copper Class B, 7-strand, concentric per ASTM B 8. Tinned copper drain wires. Pair drain wire size AWG 20, group drain wire size AWG 18.

C. Insulation and Jacket: Each conductor 15-mil PVC and 4-mil nylon insulation. Pair conductors pigmented black and red with red conductor numerically printed for group identification. Outer jacket flame retardant and sunlight and oil resistant PVC with nominal thickness as shown in table. Individual pair shield 1.35-mil aluminum/mylar. Group shield 2.35-mil aluminum/mylar, overlapped for 100% coverage.

D. Dimensions as noted in table below:

No. of Pairs	Max. Outside Dimension (inches)	Nominal Jacket Thickness(mils)
4	0.50	45
8	0.77	60
12	0.82	60
24	1.16	60

2.07 TYPE 4 (600 VOLT NO. 16 AWG, SINGLE TWISTED, SHIELDED TRIAD INSTRUMENTATION CABLE)

A. General: Twisted, shielded triad instrument cables, designed for use as instrumentation, process control, and computer cable. Suitable for installation in cable tray, conduit or other approved raceways. Minimum cable temperature rating shall be 90°C dry locations, 75°C wet locations.

B. Conductors: Bare soft annealed copper Class B, 7-strand, concentric per ASTM B 8. Tinned copper drain wires. Triad drain wire size AWG 18.

C. Insulation and Jacket: Each conductor 15-mil PVC and 4-mil nylon insulation. Triad conductors pigmented black, white and red. Outer jacket flame retardant and sunlight and oil resistant PVC with nominal thickness. Individual triad shield 1.35-mil aluminum/mylar.

2.08 EQUIPMENT GROUNDING CONDUCTORS

- A. Provide stranded copper conductors, as indicated or as required by NEC, for equipment grounding.
- B. Provide conductors bare.

2.09 CONNECTORS

- A. General: Provide UL type factory-fabricated, metal connectors of sizes, ampacity ratings, materials, types and classes for applications and for services indicated. Where not indicated, provide proper selection as determined by Installer to comply with project's installation requirements, NFPA-70 and NEMA standards. Select from the following those types, classes, kinds and styles of connectors to fulfill project requirements:
 - 1. Type: Pressure
 - 2. Type: Crimp
 - 3. Type: Threaded
 - 4. Class: Insulated
 - 5. Kind: Copper (for CU to CU connection)
 - 6. Style: Butt connection
 - 7. Style: Elbow connection
 - 8. Style: Combined "T" and straight connection
 - 9. Style: "T" connection
 - 10. Style: 2 or 4 bolt parallel connection. Use of split bolt connectors is prohibited
 - 11. Style: Tap connection
 - 12. Style: Pigtail connection
 - 13. Style: Wire nut connection

PART 3 - EXECUTION

3.01 INSTALLATION OF WIRES AND CABLES

- A. General: Install electrical cables, wire and wiring connectors as indicated, in compliance with applicable requirements of NFPA-70, NEMA, UL, and NECA's "Standard of Installation" and in accordance with recognized industry practices.
- B. Coordinate wire/cable installation work including electrical raceway and equipment installation work, as necessary to properly interface installation of wires/cables with other work.
- C. Install UL type wiring in conduit, for feeders and branch circuits.
- D. Pull conductors simultaneously where more than 1 is being installed in same raceway.
- E. Use pulling compound or lubricant, where necessary; compound used must not deteriorate conductor or insulator.

- F. Use pulling means including, fish tape, cable, rope and basket weave wire/cable grips, which will not damage cables or raceways.
- G. Keep conductor splices to a minimum.
- H. Install splices and tapes, which possess equivalent or better mechanical strength and insulation ratings than conductors being spliced.
- I. Use splice and tap connectors, which are compatible with conductor material.
- J. Tighten electrical connectors and terminals, including screws and bolts, in accordance with manufacturer's published torque tightening values. Where manufacturer's torquing requirements are not indicated, tighten connectors and terminals to comply with tightening torques specified in UL Standard 486A and B.
- K. Use only stranded conductors. Exception: Solid conductors size #12 and #10 AWG may be used for receptacle branch circuit wiring and lighting.
- L. Use #10 AWG conductor for 20-ampere, 120-volt branch circuit home runs longer than 75-feet, and for 20-ampere, 277-volt branch circuit home runs longer than 200-feet.
- M. Neatly train and lace wiring inside boxes, equipment, and panel boards. Support to prevent conductor movement under fault conditions.
- N. All underground wiring shall be suitable for wet locations per NEC.
- O. Discrete control 120-VAC and 4-20mA signals must not be run in same conduit. Discrete control 120-VAC and 4-20mA signal wiring in control panels and cabinets shall be separated from each other and when required, should cross perpendicular with each other to reduce signal noise.
- P. Avoid unnecessary splices. Splice only in accessible junction or outlet boxes.
- Q. Make all connections with solderless lugs.
- R. Use mechanical connectors for low voltage splices, taps, fixture and motor connections.
- S. Use insulated spade type crimp on connectors for strap screw device terminals.
- T. Where possible use connectors with integral, insulating covers. Otherwise tape uninsulated conductors and connectors to 150% of the insulation value of conductor.
- U. Thoroughly clean wires before installing lugs and connectors.
- V. Make splices, taps and terminations to carry full ampacity of conductors without perceptible temperature rise.

3.02 FIELD QUALITY CONTROL

- A. Prior to energization of circuitry, check installed wires and cables with megohm meter to determine insulation resistance levels to ensure requirements are fulfilled.
- B. Prior to energization, test wires and cables for electrical continuity and for short circuits.
- C. Subsequent to wire and cable hook-ups, energize circuitry and demonstrate functioning in accordance with requirements. Where necessary, correct malfunctioning units, and then retest to demonstrate compliance.

END OF SECTION

1

THIS PAGE LEFT BLANK INTENTIONALLY

SECTION 16135
ELECTRICAL BOXES AND FITTINGS

PART 1 - GENERAL

1.01 RELATED DOCUMENTS

- A. Drawings and general provisions of Contract, including General and Supplementary Conditions and Division 1 Specification sections, apply to work of this Section.
- B. Work described in this Section includes furnishing all labor, materials, equipment, tools and incidentals required for a complete and operable installation of boxes, bushings and locknuts. All equipment shall be installed, adjusted, tested and placed in operation in accordance with these Specifications, the manufacturer's recommendations and as shown on the Drawings.

1.02 DESCRIPTION OF WORK

- A. Extent of electrical box and associated fitting work is indicated by drawings and schedules.
- B. Types of electrical boxes and fittings specified in this Section include the following:
 - 1. Outlet boxes
 - 2. Junction boxes
 - 3. Pull boxes
 - 4. Bushings
 - 5. Locknuts

1.03 QUALITY ASSURANCE

- A. Manufacturers: Firms shall have sufficient experience that will allow for quality and successful manufacture of electrical boxes and fittings of types, sizes and capacities required for manufacture of electrical boxes and fittings required for use in this Project.
- B. Installer's Qualifications: Firms shall have sufficient experience that will allow for quality and successful installation of electrical boxes and fittings required for this Project.
- C. NFPA-70 Compliance: Comply with NFPA-70 as applicable to construction and installation of electrical wiring boxes and fittings.
- D. UL Compliance: Comply with applicable requirements of UL 50, UL 514 Series, and UL 886 pertaining to electrical boxes and fittings which are UL listed and labeled.

- E. NEMA Compliance: Comply with applicable requirements of NEMA Standard Publication Numbers OS1, OS2, and Pub.250 pertaining to outlets and device boxes, covers and box supports.
- F. Comply with NECA "Standard of Installation."
- G. Listing and Labeling: Provide products specified in this Section that are listed and labeled.
 - 1. The Terms "Listed" and "Labeled." As defined in the "National Electrical Code", Article 100.
 - 2. Listing and Labeling Agency Qualifications: A "Nationally Recognized Testing Laboratory" (NRTL) as defined in OSHA Regulation 1910.7.

1.04 SHOP DRAWINGS AND SUBMITTALS

- A. Submittals shall be submitted to the County/Professional for review and acceptance prior to construction in accordance with the General Conditions and specifications Section 01300 "Submittals."
- B. Product Data: Submit manufacturer's data on electrical boxes and fittings.
- C. A copy of this specification section with addendum updates included, and all referenced and applicable sections with addendum updates included, with each paragraph check-marked to indicate specification compliance or marked to indicate requested deviations from specification requirements. Check marks shall denote full compliance with a paragraph as a whole.
- D. If deviations from the specifications are indicated and therefore requested by the Contractor, each deviation shall be underlined and denoted by a number in the margin to the right of the identified paragraph, referenced to a detailed written explanation of the reasons for requesting the deviation.
- E. The County shall be the final authority for determining acceptability of requested deviations. The remaining portions of the paragraph not underlined will signify compliance on the part of the Contractor with the specifications.
- F. Failure to include a copy of the marked-up specification sections along with justification(s) for any requested deviations to the specification requirements, with the submittal shall be sufficient cause for rejection of the entire submittal with no further consideration.

PART 2 - PRODUCTS

2.01 GENERAL

- A. All material supplied shall be one of the products specified in Appendix D "List of Approved Products" appended to these technical specifications.

2.02 FABRICATED MATERIALS

- A. Outlet Boxes: Provide corrosion resistant cast metal rain tight outlet wiring boxes, of types, shapes and sizes, including depth of boxes, with threaded conduit holes for fastening electrical conduit, cast metal face plates with spring-hinged watertight caps suitably configured for each application, including face plate gaskets and corrosion resistant plugs and fasteners.
 1. Manufacturers: Subject to compliance with requirements, provide rain tight outlet boxes of 1 of the following:
 - a. Appleton Electric; Emerson Electric Co.
 - b. Arrow Hart Div.; Crouse-Hinds Co.
 - c. Bell Electric; Square D Co.
 - d. Harvey Hubbell, Inc.
 - e. OZ/Gedney; General Signal Co.
 - f. Pass and Seymour, Inc.
- B. Junction and Pull Boxes: Provide NEMA 4X Stainless Steel junction and pull boxes, with screw-on covers; of types, shapes, and sizes to suit each respective location and installation; with welded seams and equipped with stainless steel nuts, bolts, screws and washers.
 1. Manufacturers: Subject to compliance with requirements, provide junction and pull boxes of 1 of the following:
 - a. Adalet-PLM Div.; Scott Fetzer Co.
 - b. Appleton Electric; Emerson Electric Co.
 - c. Arrow Hart Div.; Crouse Hinds-Co.
 - d. Bell Electric; Square D Company
 - e. OZ/Gedney Co.; General Signal Co.
 - f. Spring City Electrical Mfg. Co.
- C. Bushings, Knockout Closures and Locknuts: Provide corrosion resistant box knockout closures, conduit locknuts and malleable iron conduit bushings, offset connectors, of types and sizes, to suit respective installation requirements and applications.
 1. Manufacturers: Subject to compliance with requirements, provide bushings, knockout closures, locknuts and connectors of 1 of the following:
 - a. Adalet-PLM Div.; Scott Fetzer Co.
 - b. AMP, Inc.
 - c. Arrow Hart Div.; Crouse-Hinds Co.
 - d. Appleton Electric Co.; Emerson Electric Co.
 - e. Bell Electric; Square D Co.
 - f. Midland Ross Corp.

- g. Midwest Electric; Cooper Industries, Inc.
- h. OZ/Gedney Co.; General Signal Co.
- i. RACO Div.; Harvey Hubbell, Inc.
- j. Thomas and Betts Co. Inc.

PART 3 - EXECUTION

3.01 INSTALLATION OF ELECTRICAL BOXES AND FITTINGS

- A. General: Install electrical boxes and fittings as indicated, in accordance with manufacturer's written instructions, applicable requirements of NFPA-70 and NECA's "Standard of Installation", and in accordance with recognized industry practices to fulfill project requirements.
- B. Coordinate installation of electrical boxes and fittings with wire/cable, wiring devices, and raceway installation work.
- C. Provide weather tight outlets at all locations.
- D. Provide knockout closures to cap unused knockout holes where blanks have been removed.
- E. Install electrical boxes in those locations, which ensure ready accessibility to enclosed electrical wiring.
- F. Fasten electrical boxes firmly and rigidly to substrates, or structural surfaces to which attached, or solidly embed electrical boxes in concrete or masonry.
- G. Provide electrical connections for installed boxes.
- H. Subsequent to installation of boxes, protect boxes from construction debris and damage.

3.02 GROUNDING

- A. Upon completion of installation work, properly ground electrical boxes and demonstrate compliance with requirements.

END OF SECTION

SECTION 16142
ELECTRICAL CONNECTIONS FOR EQUIPMENT

PART 1 - GENERAL

1.01 RELATED DOCUMENTS

- A. Drawings and general provisions of Contract, including General and Supplementary Conditions and Division 1 Specifications sections, apply to work of this Section.
- B. Work described in this Section includes furnishing all labor, materials, equipment, tools and incidentals required for a complete and operable installation of all electrical connections for wiring systems rated 600 volts or less. All electrical connections shall be installed, adjusted, tested and placed in operation in accordance with these Specifications, the manufacturer's recommendations and as shown on the Drawings.

1.02 DESCRIPTION OF WORK

- A. Extent of electrical connections for equipment is indicated by drawings and schedules. Electrical connections are hereby defined to include connections used for providing electrical power to equipment.
- B. Applications of electrical power connections specified in this Section include the following, but not limited:
 - 1. From electrical source to control panel
 - 2. From control panel to motors and control devices
- C. Electrical connections for equipment, not furnished as integral part of equipment, are specified in Division 15 and other Division 16 sections, and are work of this Section.
- D. Refer to Division 15 sections for motor starters and controller furnished integrally with equipment; not work of this Section.
- E. Junction boxes and disconnect switches required for connecting motors and other electrical units of equipment are specified in applicable Division 16 sections, and are work of this Section.
- F. Raceways and wires/cables required for connecting motors and other electrical units of equipment are specified in applicable Division 16 sections, and are work of this Section.
- G. Refer to Division 15 or Division 13 sections as applicable for control system wiring; not work of this Section.
- H. Refer to sections of other Divisions for specific individual equipment power requirements, not work of this Section.

1.03 QUALITY ASSURANCE

- A. Manufacturers: Firms shall have sufficient experience and be regularly engaged in manufacture of electrical connectors and terminals, of types and rating required, and ancillary connection materials, including electrical insulating tape, soldering fluxes, and cable ties, whose products have been in satisfactory use in projects with similar service as this Project.
- B. Installer's Qualifications: Firms shall have sufficient experience to allow for quality and successful installation utilizing electrical connections for equipment for this Project.
- C. NFPA-70 Compliance: Comply with applicable requirements of NFPA-70 as to type of products used and installation of electrical power connections (terminals and splices), for junction boxes, motor starters and disconnect switches.
- D. IEEE Compliance: Comply with Std. 241, "IEEE Recommended Practice for Electric Power Systems in Commercial Buildings" pertaining to connections and terminations.
- E. ANSI Compliance: Comply with applicable requirement of ANSI/NEMA and ANSI/EIA standards pertaining to products and installation of electrical connections for equipment.
- F. UL Compliance: Comply with UL Std.486A, "Wire Connectors and Soldering Lugs for Use with Copper Conductors" including, but not limited to, tightening of electrical connectors to torque values indicated. Provide electrical connection products and materials which are UL listed and labeled.

1.04 SHOP DRAWINGS AND SUBMITTALS

- A. Submittals shall be submitted to the County/Professional for review and acceptance prior to construction in accordance with the General Conditions and specifications Section 01300 "Submittals."
- B. Product Data: Submit manufacturer's data on electrical connections for equipment products and materials.
- C. A copy of this specification section with addendum updates included, and all referenced and applicable sections with addendum updates included, with each paragraph check-marked to indicate specification compliance or marked to indicate requested deviations from specification requirements. Check marks shall denote full compliance with a paragraph as a whole.
- D. If deviations from the specifications are indicated, and therefore requested by the Contractor, each deviation shall be underlined and denoted by a number in the margin to the right of the identified paragraph, referenced to a detailed written explanation of the reasons for requesting the deviation.
- E. The County shall be the final authority for determining acceptability of requested deviations. The remaining portions of the paragraph not underlined will signify compliance on the part of the Contractor with the specifications.

- F. Failure to include a copy of the marked-up specification sections along with justification(s) for any requested deviations to the specification requirements, with the submittal shall be sufficient cause for rejection of the entire submittal with no further consideration.

PART 2 - PRODUCTS

2.01 GENERAL

- A. All material supplied shall be one of the products specified in Appendix D "List of Approved Products" appended to these technical specifications.

2.02 ACCEPTABLE MANUFACTURERS

- A. Manufacturers: Subject to compliance with requirements, provide products of one of the following (for each type of product):
 1. Adalet PLM Div., Scott and Fetzer Co.
 2. Allen Stevens Conduit Fittings Corp.
 3. AMP Inc.
 4. Appleton Electric Co.
 5. Arrow Hart Div., Crouse Hinds Co.
 6. Burndy Corp.
 7. General Electric Co.
 8. Harvey Hubbell Inc.
 9. Ideal Industries, Inc.
 10. Pyle National Co.
 11. Reliable Electric Co.
 12. Square D Company
 13. Thomas and Betts Corp.

2.03 MATERIALS AND COMPONENTS

- A. General: For each electrical connection indicated, provide complete assembly of materials, including but not necessarily limited to; pressure connectors, terminals (lugs), electrical insulating tape, heat shrinkable insulating tubing, cables ties, solderless wire nuts, and other items and accessories as needed to complete splices and terminations of types indicated.

2.04 CONDUIT, TUBING AND FITTINGS

- A. General: Provide conduit, tubing, and fittings of types, grades, sizes, and weights (wall thickness) indicated for each type service. Where types and grades are not indicated, provide proper selection to fulfill wiring requirements, and comply with NFPA-70 requirements for raceways. Provide products complying with Section 16110 "Raceways" and in accordance with the following listing of conduit, tubing and fittings:
 1. Schedule 80 PVC conduit
 2. Schedule 80 PVC fittings

3. Liquid-tight flexible metal conduit
4. Liquid-tight flexible metal conduit fittings
5. Rigid aluminum conduit
6. Rigid aluminum conduit fittings

2.05 WIRES, CABLES AND CONNECTORS

- A. General: Provide wires, cables, and connectors complying with Section 16120 "Wires and Cables."
- B. Wires/Cables: Unless otherwise indicated, provide wires/cables (conductors) for electrical connections which match, including sizes and ratings, of wires/cables which are supplying electrical power. Provide copper conductors with conductivity of not less than 98% at 20°C (68°F)
- C. Connectors and Terminals: Provide electrical connectors and terminals which mate and match, including sizes and ratings, with equipment terminals and are recommended by equipment manufacturer for intended applications.
- D. Electrical Connection Accessories: Provide electrical insulating tape, heat shrinkable insulating tubing and boots, wire nuts and cable ties as recommended for use by accessories manufacturers for type services indicated.

PART 3 - EXECUTION

3.01 INSPECTION

- A. Inspect area and conditions under which electrical connections for equipment are to be installed and notify Contractor in writing of conditions detrimental to proper completion of the Work. Do not proceed with the Work until unsatisfactory conditions have been corrected in a manner acceptable to Installer and/or owner as applicable.

3.02 INSTALLATION OF ELECTRICAL CONNECTIONS

- A. Install electrical connections as indicated; in accordance with equipment manufacturer's written instructions and with recognized industry practices, and complying with applicable requirements of UL, NFPA-70, and NECA's "Standard of Installation" to ensure that products fulfill requirements.
- B. Coordinate with other work, including wires/cables, raceways and equipment installation, as necessary to properly interface installment of electrical connections for equipment with other work.
- C. Connect electrical power supply conductors to equipment conductors in accordance with equipment manufacturer's written instructions and wiring diagrams. Mate and match conductors of electrical connections for proper interface between electrical power supplies and installed equipment.

- D. Cover splices with electrical insulating material equivalent to, or of greater insulation resistivity ratings, than electrical insulation rating of those conductors being spliced.
- E. Prepare cables and wires, by cutting and stripping covering armor, jacket, and insulation properly to ensure uniform and neat appearance where cables and wires are terminated. Exercise care to avoid cutting through tapes, which will remain on conductors. Also avoid "ringing" copper conductors while skinning wire.
- F. Tighten connectors and terminals, including screws and bolts, in accordance with equipment manufacturers published torque-tightening values for equipment connectors. Accomplish tightening by utilizing proper torquing tools, including torque screwdriver, bean type torque wrench, and ratchet wrench with adjustable torque settings. Where manufacturer's torquing requirements are not available, tighten connectors and terminals to comply with torquing values contained in UL's 486A.
- G. Provide liquid tight flexible conduit for connections of motors and other electrical equipment where subject to movement and vibration.
- H. Fasten identification markers to each electrical power supply wire/cable conductor which indicates their voltage, phase and feeder number in accordance with Section 16195 "Electrical Identification." Affix markers on each terminal conductor, as close as possible to the point of connection.

3.03 FIELD QUALITY CONTROL

- A. Upon completion of installation of electrical connections, and after circuitry has been energized with rated power source, test connections to demonstrate capability and compliance with requirements. Ensure that direction of rotation of each motor fulfills requirement. Correct malfunctioning units at site, then retest to demonstrate compliance.

END OF SECTION

1

THIS PAGE LEFT BLANK INTENTIONALLY

SECTION 16143
WIRING DEVICES

PART 1 - GENERAL

1.01 RELATED DOCUMENTS

- A. Drawings and general provisions of Contract, including General and Supplementary Conditions and Division 1 Specification sections, apply to work of this Section.

1.02 DESCRIPTION OF WORK

- A. The extent of wiring device work is indicated by drawings and schedules. Wiring devices are defined as single discrete units of electrical distribution systems which are intended to carry but not utilize electrical energy.
- B. Work described in this Section includes furnishing all labor, materials, equipment, tools and incidentals required for a complete and operable installation of wall switches, receptacles, plugs, device plates and box covers. All equipment shall be installed, adjusted, tested and placed in operation in accordance with these Specifications, the manufacturer's recommendations and as shown on the Drawings.
- C. Types of electrical wiring devices in this Section include the following:
 - 1. Receptacles
 - 2. Ground fault circuit interrupters
 - 3. Switches

1.03 QUALITY ASSURANCE

- A. Manufacturers: Firms shall have sufficient experience in manufacture of electrical wiring devices, of types, sizes, and ratings required that will allow for quality and successful manufacture of wiring devices required for this Project.
- B. Installer's Qualifications: Firms shall have sufficient experience to allow for quality and successful installation of wiring devices required for this Project.
- C. NFPA-70 Compliance: Comply with NFPA-70 as applicable to installation and wiring of electrical wiring devices.
- D. UL Compliance: Comply with applicable requirements of UL 20, 486A, 498, and 943 pertaining to installation of wiring devices. Provide wiring devices which are UL listed and labeled.

- E. IEEE Compliance: Comply with applicable requirements of IEEE Standard 241, "Recommended Practice for Electric Power Systems in Commercial Buildings", pertaining to electrical wiring systems.
- F. NEMA Compliance: Comply with applicable portions of NEMA Standards Publication Number WD 1, "General Purpose Wiring Devices," and WD 5 "Specific Purpose Wiring Devices."
- G. OSHA Compliance: Comply with latest standards of the U.S. Department of Labor, Occupational Safety and Health Administration.
- H. Listing and Labeling: Provide products that are listed and labeled for their applications and installation conditions and for the environments in which installed.
 - 1. The Terms "Listed" and "Labeled": As defined in the "National Electrical Code," Article 100.
 - 2. Listing and Labeling Agency Qualifications: A "Nationally Recognized Testing Laboratory" (NRTL) as defined in OSHA Regulation 1910.7.

1.04 SHOP DRAWINGS AND SUBMITTALS

- A. Submittals shall be submitted to the County/Professional for review and acceptance prior to construction in accordance with the General Conditions and specifications Section 01300 "Submittals."
- B. Product Data: Submit manufacturer's data on electrical wiring devices.
- C. A copy of this specification section, with addendum updates included, and all referenced and applicable sections, with addendum updates included, with each paragraph check-marked to indicate specification compliance or marked to indicate requested deviations from specification requirements. Check marks shall denote full compliance with a paragraph as a whole.
- D. If deviations from the specifications are indicated, and therefore requested by the Contractor, each deviation shall be underlined and denoted by a number in the margin to the right of the identified paragraph, referenced to a detailed written explanation of the reasons for requesting the deviation.
- E. The County shall be the final authority for determining acceptability of requested deviations. The remaining portions of the paragraph not underlined will signify compliance on the part of the Contractor with the specifications.
- F. Failure to include a copy of the marked-up specification sections, along with justification(s) for any requested deviations to the specification requirements, with the submittal shall be sufficient cause for rejection of the entire submittal with no further consideration.

PART 2 - PRODUCTS

2.01 GENERAL

- A. All material supplied shall be one of the products specified in Appendix D "List of Approved Products" appended to these technical specifications.

2.02 ACCEPTABLE MANUFACTURERS

- A. Manufacturers: Subject to compliance with requirements, provide wiring devices of one of the following (for each type and rating of wiring device):
 1. Arrow Hart Div., Crouse Hinds Co.
 2. Bryant Electric Co.
 3. Harvey Hubbell Inc.
 4. Leviton Mfg. Co.
 5. Pass and Seymour Inc.
 6. Crouse Hinds.
 7. Appleton.
 8. Or approved equal.
- B. Wiring devices shall be UL approved for the current and voltage specified and shall comply with NEMA WD 1. Devices shall contain provisions for back wiring and side wiring with captive binding screws.

Provide devices colored to conform to manufacturer's or industry standard for special use such as orange for isolated ground receptacles, blue for surge suppression receptacles, and red for emergency power receptacles. Unless shown otherwise on the Drawings or Schedules, normal use devices shall be gray, except those located in finished areas shall be ivory.

2.03 FABRICATED WIRING DEVICES

- A. General: Provide factory fabricated wiring devices, in types, colors, and electrical ratings for applications indicated and which comply with NEMA Standards Publication Number WD 1.

2.04 RECEPTACLES

- A. Comply with NEMA Standard WD 1.
- B. Enclosures: NEMA 1 equivalent, except as otherwise indicated.
- C. Color: Unless noted otherwise by Architect or required by Code.
 1. Surface mounted unfinished areas: Gray.
 2. Flush mounted finished areas: Ivory.

- D. Receptacles, Straight-Blade and Locking Type: Comply with UL Standard 498, heavy-duty specification grade except as otherwise indicated.
- E. Receptacles, Straight-Blade, Special Features: Comply with the basic requirements specified herein for straight-blade receptacles of the class and type indicated, and with the following additional requirements:
 - 1. Ground-Fault Circuit Interrupter (GFCI) Receptacles: UL Standard 943, feed-through type, with integral NEMA 5-20R duplex receptacles arranged to protect connected downstream receptacles on the same circuit. Design units for installation in a 2-1/2-inch deep outlet box without an adapter. Ground-fault trip level shall be 5 milliamperes, and shall be noise-suppressed to the extent that nuisance tripping will be either eliminated or minimized.
 - 2. Line and load terminal screws: Ensure that connection to load terminals will ensure ground fault protection for other receptacles and loads connected to those terminals.
- F. Receptacles, Industrial Heavy-Duty: Conform to NEMA Standard PK 4.
- G. Except as otherwise noted on the Drawings or specified herein, receptacles shall be 125 Volt, 20-Ampere, ANSI C73.12, configuration 5-20R; grounded type; conforming to FS W-C-596/41 for single and FS W-C-596/40 for duplex receptacles and shall accept NEMA 5-15P and 5-20P plugs. Where the manufacturer of cord-connected equipment requires an isolated ground, a receptacle with isolated ground shall be provided.
- H. Ground Fault Interrupter (GFI) Receptacles: Provide duplex specification grade GFI receptacles tripping at 5-milliamperes; rated 20-amperes, 120 volts, NEMA Configuration 5-20R. Use units meeting NEMA WD 1, fitting standard sized outlet boxes having provision for testing, and ivory in color. Use standard model where ground fault protection is needed. Acceptable manufacturers are Square D, General Electric, or equal.
- I. Except as otherwise noted on the Drawings or specified herein, outdoor, process corrosive and chemical areas, receptacles shall be duplex, 20-ampere, NEMA 5-20R, and shall accept NEMA 5-15P and 5-20P plugs. Receptacle and plug shall be corrosion resistant but not marine duty with weatherproof lift covers. For outdoor locations use plastic or Lexan phenolic cover which can maintain the weatherproof integrity while in use.
- J. Receptacles shall be side or back wired with two screws per terminal.
- K. Body shall be thermoplastic compound or impact resistant nylon face supported by mounting yoke having plaster ears.
- L. Three phase receptacles and plugs shall be suitable for 480 volt, 3-phase, 4-wire service, with ampere ratings as specified. Receptacles and plugs shall be designed so that the grounding pole is permanently connected to the housing. The grounding pole shall make contact before the line poles are engaged when the plug is connected to the receptacle housing. The plug sleeve shall also make contact with the receptacle housing before the line and load poles make contact. Receptacles shall be provided complete with cast back box, angle adapter, gaskets, and a gasketed screw-type, weathertight cap with chain fastener.

- M. Install convenience outlets, in suitable steel outlet boxes centered at the height of 18-inches above the finished floor, 6-inches above countertop or at the backsplash level, or as indicated on the Drawings. Coordinate with equipment and architectural Drawings.

2.05 SWITCHES

- A. Snap: General purpose switches NEMA WD-1, shall be quiet AC type, NRTL listed and labeled as complying with UL Standard 20 "General Use Snap Switches," and with Federal Specification W-S 896, specification grade, back and side wired, and shall be provided in accordance with rated capacities as required or as indicated on Drawings or Schedules. Switches shall match receptacles in color. Unless otherwise indicated switches shall be 20-amp, 120/277 volt, toggle handle.
- B. Double Snap: Provide general duty flush double pole AC quiet switches, 20-amperes, 120/277 volts, with mounting yoke insulated from mechanism, equip with plaster ears, switch handles, side wired screw terminals, with break off tab features, which allow wiring with separate or common feed.
- C. Switches shall be 20-ampere with weatherproof/corrosion resistant neoprene plate for corrosive and outdoor areas. Switches shall be mounted in "FS" type copper-free aluminum or PVC mounting boxes.
- D. Switches shall be totally enclosed, specification grade, rated 20-ampere, 277/120 volt AC; conforming to FS W-S-896E, with phenolic body, base and toggles.

2.06 WIRING DEVICE ACCESSORIES

- A. Cover plates: Provide cover plates for single and combination wiring devices, of types, sizes and with ganging and cutouts as indicated. Select plates which mate and match wiring devices to which attached. Construct with metal screws for securing plates to devices. Cover plates shall be cast ferrous or aluminum, weatherproof, gasketed type.

PART 3 - EXECUTION

3.01 INSTALLATION OF WIRING DEVICES

- A. Install wiring devices as indicated, in accordance with manufacturer's written instructions, applicable requirements of NFPA-70 and NECA's "Standard of Installation" and in accordance with recognized industry practices to fulfill project requirements.
- B. Coordinate with other work, including painting, electrical boxes and wiring work, as necessary to interface installation of wiring devices with other work.
- C. Install wiring devices only in electrical boxes, which are clean, free from excess building materials, dirt and debris.
- D. Install wiring devices after wiring work is completed.

- E. Tighten connectors and terminals, including screws and bolts, in accordance with equipment manufacturer's published torque tightening values for wiring devices. Where manufacturer's torquing requirements are not indicated, tighten connectors and terminals to comply with tightening torques specified in UL Standards 486A and B. Use properly scaled torque indicating hand tool.
- F. Unless noted otherwise on the Drawings, receptacles and jacks shall be mounted 18-inches above finished floor or approximately 6-inches above countertops, work surfaces or similar surfaces where applicable. Switches shall be mounted 48-inches above finished floor, unless noted otherwise. For wet or damp unfinished areas receptacles shall be mounted at 24-inches.
- G. Boxes shall be independently supported by galvanized brackets, expansion bolts, toggle bolts, or machine or wood screws as appropriate. Wooden plugs inserted in masonry or concrete shall not be used as a base to secure boxes, nor shall welding or brazing be used for attachment. Where installed outdoors or subject to corrosion, all supporting brackets shall be 316 Stainless Steel.

3.02 GROUNDING

- A. Provide equipment-grounding connections for wiring devices, unless otherwise indicated. Tighten connections to comply with tightening torques specified in UL Standard 486A to assure permanent and effective grounds.
- B. All wiring devices shall be grounded per Code.
- C. Isolated Ground Receptacles: Connect to isolated grounding conductor routed to designated isolated equipment ground terminal of electrical system.

3.03 TESTING

- A. Prior to energizing circuitry, test wiring for electrical continuity, and for short circuits. Ensure proper polarity of connections is maintained. Subsequent to energization, test wiring devices to demonstrate compliance with requirements.
- B. Testing: Test wiring devices for proper polarity and ground continuity. Operate each operable device at least 6 (six) times.
- C. Test ground-fault circuit interrupter operation with both local and remote fault simulations according to manufacturer recommendations.
- D. Replace damaged or defective components.

END OF SECTION

SECTION 16170
CIRCUIT AND MOTOR DISCONNECTS

PART 1 - GENERAL

1.01 RELATED DOCUMENTS

- A. Drawings and general provisions of Contract, including General and Supplementary Conditions and Division 1 Specification sections, apply to work of this Section.

1.02 DESCRIPTION OF WORK

- A. Extent of circuit and motor disconnect switch work is indicated on drawings and schedules.
- B. Work described in this Section includes furnishing all labor, materials, equipment, tools and incidentals required for a complete and operable installation of disconnect switches and enclosures. All equipment shall be installed, adjusted, tested and placed in operation in accordance with these Specifications, the manufacturer's recommendations and as shown on the Drawings. This section includes individually mounted switches used for the following:
 - 1. Equipment disconnects
 - 2. Motor circuit disconnects
- C. Refer to other Division 16 sections for wires/cables, raceways, and electrical boxes and fittings work required in connection with circuit and motor disconnect work; not work of this Section.

1.03 QUALITY ASSURANCE

- A. Manufacturers: Firms shall have sufficient experience in the manufacture of circuit and motor disconnect switches of types and capacities required, for quality and successful manufacture of circuit and motor disconnects.
- B. Installer's Qualifications: Firms shall have sufficient experience to allow for quality and successful installation of circuit and motor disconnects for use in this Project.
- C. NFPA-70 Compliance: Comply with NFPA-70 requirements pertaining to construction and installation of electrical circuit and motor disconnect devices.
- D. UL Compliance: Comply with requirements of UL 98, "Enclosed and Dead Front Switches." Provide circuit and motor disconnect switches which have been UL listed and labeled.

- E. NEMA Compliance: Comply with applicable requirements of NEMA Standards Publication Number KS 1, "Enclosed Switches" and 250 "Enclosures for Electrical Equipment" (1,000 volts maximum).
- F. Listing and Labeling: provide disconnect switches specified in this Section that are listed and labeled.
 - 1. The Terms "Listed" and "Labeled." As defined in the "National Electrical Code", Article 100.
 - 2. Listing and Labeling Agency Qualifications: A "Nationally Recognized Testing Laboratory" (NRTL) as defined in OSHA Regulation 1910.7.

1.04 SHOP DRAWINGS AND SUBMITTALS

- A. Submittals shall be submitted to the County/Professional for review and acceptance prior to construction in accordance with the General Conditions and specifications Section 01300 "Submittals."
- B. Data: Submit manufacturer's data on circuit and motor disconnect switches.
- C. A copy of this specification section, with addendum updates included, and all referenced and applicable sections, with addendum updates included, with each paragraph check-marked to indicate specification compliance or marked to indicate requested deviations from specification requirements. Check marks shall denote full compliance with a paragraph as a whole.
- D. If deviations from the specifications are indicated, and therefore requested by the Contractor, each deviation shall be underlined and denoted by a number in the margin to the right of the identified paragraph, referenced to a detailed written explanation of the reasons for requesting the deviation.
- E. The County shall be the final authority for determining acceptability of requested deviations. The remaining portions of the paragraph not underlined will signify compliance on the part of the Contractor with the specifications.
- F. Failure to include a copy of the marked-up specification sections, along with justification(s) for any requested deviations to the specification requirements, with the submittal shall be sufficient cause for rejection of the entire submittal with no further consideration.

PART 2 - PRODUCTS

2.01 GENERAL

- A. All material supplied shall be one of the products specified in Appendix D "List of Approved Products" appended to these technical specifications.

2.02 ACCEPTABLE MANUFACTURERS

- A. Manufacturer: Subject to compliance with requirements, provide circuit and motor disconnects of one of the following for each type of switch (refer to Appendix D "List of Approved Products."

2.03 DISCONNECTS

- A. Disconnects shall be rated for the maximum available fault current available at the point of connection. For 600V systems, an additional UL approved lockable, non-fused, safety type switch utility service disconnect shall be installed ahead of meter.
- B. Where pump motor disconnect and starter is not mounted within sight of pump wetwell, where electrical equipment is mounted within a building or other enclosure, provide additional NEMA 4X stainless steel 316 non-fused disconnect for each pump within sight of pump location.
- C. Enclosed, Non-fusible Switch: 600 Volts, heavy-duty, single throw safety switch, with lockable handle. Quantity of poles and ampere rating shall be as required to meet the application. Also, switches for motor applications shall be horsepower rated to meet or exceed the connected motor load. Square D Class 3110, or equal.
- D. Enclosure: As specified or required to meet environmental conditions of installed location:
 - 1. Dry Indoor Locations: NEMA 1
 - 2. Outdoor Locations: NEMA 3R, 316 Stainless Steel
 - 3. Wet, Damp or corrosive Locations: NEMA 4X , 316 Stainless Steel
 - 4. Below Grade Locations: NEMA 4, 316 Stainless Steel
 - 5. NEC Class 1 Hazardous Locations: NEMA 7 with applicable Group (A, B, C, D) rating.
- E. Switches shall have handles lockable with two padlocks and shall have a dual cover interlock.
- F. Disconnect switches used on single phase, 3-wire or 3-phase, 4-wire applications shall have a factory installed neutral assembly.
- G. Disconnect switches shall have a field installed grounding lug.

2.04 FUSES

- A. Enclosed, Fusible Switch: 600 Volts, heavy-duty, and single throw safety switch with lockable handle and with clips to accommodate specified fuses. Fuse size shall be per Contract Drawings and/or to match protected equipment manufacturers recommendation. Quantity of poles and ampere rating shall be as required to meet the application. Also, switches for motor applications shall be horsepower rated to meet or exceed the connected motor load. Square D Class 3110, or equal. Provide fuses for equipment as required and as recommended by switch manufacturer, of classes, types, and ratings needed to fulfill electrical requirements for service indicated.

PART 3 - EXECUTION

3.01 INSTALLATION OF CIRCUIT AND MOTOR DISCONNECT SWITCHES

- A. Install circuit and motor disconnect devices as indicated complying with manufacturer's written instructions, applicable requirements of NFPA-70, NEMA and NECA's "Standard of Installation," and in accordance with recognized industry practices.
- B. Connect disconnect switches and components to wiring system and to ground as indicated and instructed by manufacturer. Tighten electrical connectors and terminals according to manufacturer's published torque-tightening values. Where manufacturer's torque values are not indicated, use those specified in UL 486A and UL 486B.
- C. Coordinate circuit and motor disconnect device installation work with electrical raceway and cable work, as necessary for proper interface.
- D. Install disconnect devices for use with motor driven appliances, and motors and controllers within sight of controller position unless otherwise indicated.

3.02 GROUNDING

- A. Provide equipment grounding connections, sufficiently tight to assure a permanent and effective ground, for electrical disconnect switches per the National Electrical Code (NEC).

3.03 FIELD QUALITY CONTROL

- A. Subsequent to completion of installation of electrical disconnect switches, energize circuitry and demonstrate capability and compliance with requirements. Correct malfunction units at project site where possible, then retest to demonstrate compliance; otherwise remove and replace with new units and retest.

END OF SECTION

SECTION 16180
OVER CURRENT PROTECTIVE DEVICES

PART 1 - GENERAL

1.01 RELATED DOCUMENTS

- A. Drawings and general provisions of Contract, including General and Supplementary Conditions and Division 1 Specification sections, apply to work of this Section.

1.02 DESCRIPTION OF WORK

- A. Extent of over-current protective device work is indicated by drawings and schedules.
- B. Work described in this Section includes furnishing all labor, materials, equipment, tools and incidentals required for a complete installation of all electrical equipment and systems with over-current protection. All equipment shall be installed, adjusted, tested and placed in operation in accordance with these Specifications, the manufacturer's recommendations and as shown on the Drawings. Types of over-current protective devices in this Section include the following:
 - 1. Circuit Breakers
 - a. Molded Case
- C. Refer to other Division 16 sections for cable/wire and connector work required in conjunction with over-current protective devices; not work of this Section.

1.03 QUALITY ASSURANCE

- A. Manufacturers: Firms shall have sufficient experience in the manufacture of over-current protective devices, of types, sizes, and ratings required, for quality and successful manufacture of over-current and protective devices for use in this Project.
- B. Installer: Firms shall have sufficient experience to allow for quality and successful installation of over-current and protective devices required for this Project.
- C. NFPA-70 Compliance: Comply with NFPA-70 requirements as applicable to construction and installation of over-current protective devices.
- D. UL Compliance: Comply with applicable requirements of UL 489, "Molded Case Circuit Breakers and Circuit Breaker Enclosures." Provide over-current protective devices which are UL listed and labeled.
- E. NEMA Compliance: Comply with applicable requirements of NEMA Standard Publication Numbers AB 1, AB 2, and SG 3 pertaining to molded case and low voltage power type circuit breakers.

- F. Listing and Labeling: Provide products specified in this Section that are listed and labeled.
 - 1. The Terms "Listed and Labeled." As defined in the "National Electrical Code," Article 100.
 - 2. Listing and Labeling Agency Qualifications: A "Nationally Recognized Testing Laboratory" (NRTL) as defined in OSHA Regulation 1910.7.

1.04 SHOP DRAWINGS AND SUBMITTALS

- A. Submittals shall be submitted to the County/Professional for review and acceptance prior to construction in accordance with the General Conditions and specifications Section 01300 "Submittals."
- B. Product Data: Submit manufacturer's data on over-current protective devices, including amperes, voltages, and current ratings, interrupting ratings, current limitations, internal inductive and non-inductive loads, time current trip characteristic curves, and mounting requirements.
- C. A copy of this specification section with addendum updates included, and all referenced and applicable sections with addendum updates included, with each paragraph check-marked to indicate specification compliance or marked to indicate requested deviations from specification requirements. Check marks shall denote full compliance with a paragraph as a whole.
- D. If deviations from the specifications are indicated, and therefore requested by the Contractor, each deviation shall be underlined and denoted by a number in the margin to the right of the identified paragraph, referenced to a detailed written explanation of the reasons for requesting the deviation.
- E. The County shall be the final authority for determining acceptability of requested deviations. The remaining portions of the paragraph not underlined will signify compliance on the part of the Contractor with the specifications.
- F. Failure to include a copy of the marked-up specification sections along with justification(s) for any requested deviations to the specification requirements with the submittal, shall be sufficient cause for rejection of the entire submittal with no further consideration.

PART 2 - PRODUCTS

2.01 GENERAL

- A. All material supplied shall be one of the products specified in Appendix D "List of Approved Products" appended to these technical specifications.

2.02 ACCEPTABLE MANUFACTURERS

- A. Manufacturers: Subject to compliance with requirements, provide products of one of the following (for each type and rating of over-current protective device.)
1. Circuit Breakers: (See Appendix D "List of Approved Products".)

2.03 CIRCUIT BREAKERS

- A. General: Except as otherwise indicated, provide circuit breakers and ancillary components, of types, sizes, ratings and electrical characteristics indicated, which comply with manufacturer's standard design, materials, components, and construction in accordance with published product information and as required for a complete installation.
- B. Molded Case Circuit Breakers: Provide factory assembled, molded case circuit breakers of frame size indicated. Provide breakers with permanent thermal and instantaneous magnetic trips in each pole, and with fault current limiting protection, ampere rating as indicated. Construct with over center, trip free, toggle type operating mechanisms with quick make, quick break action and positive handle trip indication. Provide push to trip button on cover for mechanical tripping circuit breakers. All latch surfaces shall be ground and polished. All poles shall be so constructed that they open, close and trip simultaneously. Circuit breakers must be completely enclosed in a high strength polyester molded case. Ampere rating shall be clearly visible. Contacts shall be on non-welding silver alloy. Arc extinction must be accomplished by means of arc chutes. Construct breakers for mounting and operating in any physical position and operating in an ambient temperature of 40°C. Provide breakers with mechanical screw type removable connector lugs, AL/CU rated. Mount individual circuit breakers complying with requirements for circuit breakers in this Section in enclosure required for the location, unless otherwise indicated. Provide circuit breakers with handles that can be locked in the OFF position. Interlock enclosure and circuit breaker to prevent opening the cover with the circuit breaker in the ON position. Provide thermal magnetic circuit breaker, unless otherwise shown, for one-pole and two pole breakers, breakers operating at 240V or less, and 3 (three) pole branch circuit breakers operating at 480V.

PART 3 - EXECUTION

3.01 INSTALLATION OF OVER CURRENT PROTECTIVE DEVICES

- A. Install over current protective devices as indicated, in accordance with manufacturer's written instructions and with recognized industry practices to ensure that protective devices comply with requirements. Comply with NFPA-70 and NEMA standards for installation of over current protective devices.
- B. Coordinate with other work, including electrical wiring work, as necessary to interface installation of over current protective devices with other work.

- C. Fasten circuit breakers without causing mechanical stresses, twisting or misalignment being exerted by clamps, supports, or cabling.
- D. Set field adjustable circuit breakers for trip settings as indicated, subsequent to installation of units.

3.02 ADJUST AND CLEAN:

- A. Inspect circuit breakers operating mechanisms for malfunctioning and, where necessary, adjust units for free mechanical movement.

3.03 FIELD QUALITY CONTROL

- A. Prior to energizing of over current protective devices, test devices for continuity of circuitry and for short circuits. Correct malfunctions in units, and then demonstrate compliance with requirements.

END OF SECTION

SECTION 16190
SUPPORTING DEVICES

PART 1 - GENERAL

1.01 RELATED DOCUMENTS

- A. Drawings and general provisions of Contract, including General and Supplementary Conditions, and Division 1 Specification sections, apply to work of this Section.

1.02 DESCRIPTION OF WORK

- A. Extent of supports, anchors, sleeves and seals is indicated by drawings and schedules and/or specified in other Division 16 sections.
- B. Types of supports, anchors, sleeves and seals specified in this Section include the following:
 - 1. C clamps
 - 2. Nuts and bolts
 - 3. One-hole conduit straps
 - 4. Round steel rods and associated hardware
 - 5. Support channels

1.03 QUALITY ASSURANCE

- A. Manufacturers: Firms shall sufficient experience in the manufacture of supporting devices, of types, sizes, and ratings required for quality and successful manufacture of supporting devices for use in this Project.
- B. Installers Qualifications: Firms shall sufficient experience to allow for quality and successful installation of supporting devices required for use in this Project.
- C. NFPA-70 Compliance: Comply with NFPA-70 requirements as applicable to construction and installation of electrical supporting devices.
- D. NECA Compliance: Comply with National Electrical Contractors Association's "Standard of Installation" pertaining to anchors, fasteners, hangers, supports, and equipment mounting.
- E. UL Compliance: Provide electrical components which are UL listed and labeled.
- F. Listing and Labeling: Provide products specified in this Section that are listed and labeled.
 - 1. The Terms "Listed and Labeled." As defined in the "National Electrical Code," Article 100.
 - 2. Listing and Labeling Agency Qualifications: A "Nationally Recognized Testing Laboratory" (NRTL) as defined in OSHA Regulation 1910.7.

1.04 SHOP DRAWINGS AND SUBMITTALS

- A. Submittals shall be submitted to the County/Professional for review and acceptance prior to construction in accordance with the General Conditions and specifications Section 01300 "Submittal."
- B. Product Data: Submit manufacturer's data on supporting devices including catalog cuts, specifications, and installation instructions, for each type of support, anchor, sleeve and seal.
- C. A copy of this specification section with addendum updates included, and all referenced and applicable sections with addendum updates included, with each paragraph check-marked to indicate specification compliance or marked to indicate requested deviations from specification requirements. Check marks shall denote full compliance with a paragraph as a whole.
- D. If deviations from the specifications are indicated, and therefore requested by the Contractor, each deviation shall be underlined and denoted by a number in the margin to the right of the identified paragraph, referenced to a detailed written explanation of the reasons for requesting the deviation.
- E. The County shall be the final authority for determining acceptability of requested deviations. The remaining portions of the paragraph not underlined will signify compliance on the part of the Contractor with the specifications.
- F. Failure to include a copy of the marked-up specification sections, along with justification(s) for any requested deviations to the specification requirements with the submittal shall be sufficient cause for rejection of the entire submittal with no further consideration.

PART 2 - PRODUCTS

2.01 GENERAL

- A. All material supplied shall be one of the products specified in Appendix D "List of Approved Products" appended to these technical specifications.

2.02 MANUFACTURED SUPPORTING DEVICES

- A. General: Provide supporting devices which comply with manufacturer's standard materials, design, and construction in accordance with published product information, and as required for complete installation; and as herein specified. Where more than one type of supporting device meets indicated requirement, selection is Installer's option.
- B. Supports: Provide supporting devices of types, sizes and materials indicated; and having the following construction features:
 - 1. C Clamps: Stainless Steel: 1/2-inch rod size; approximately 70-pounds per 100-units.
 - 2. I Beam Clamps: Stainless steel, 1-1/4-inch x 3/16-inch stock; 3/8-inch cross bolt; flange width 2-inches; approximately 52-pounds per 100-units.
 - 3. One-Hole Conduit Straps: For supporting 3/4-inch rigid metal conduit; stainless steel; approximately 7-pounds per 100-units.

4. Hexagon Nuts: For 1/2-inch rod size; stainless steel; approximately 4-pounds per 100-units.
 5. Threaded round Steel Rod: Stainless Steel; 1/2-inch dia.; approximately 67-pounds per 100-feet.
 6. Offset Conduit Clamps: For supporting rigid metal conduit; stainless steel.
- C. Anchors: Provide anchors of types, sizes, and materials indicated, with the following construction features:
1. Lead Expansion Anchors: 1/2-inch; approximately 38-pounds per 100-units.
 2. Toggle Bolts: Springhead; stainless steel 3/16-inch by 4-inches; approximately 5-pounds per 100-units.
 3. Manufacturers: Subject to compliance with requirements, provide anchors of one of the following:
 - a. Ideal Industries, Inc.
 - b. Joslyn Mfg. and Supply Co.
 - c. McGraw Edison Co.
 - d. Star Expansion Co.
 - e. U.S. Expansion Bolt Co.
- D. Sleeves and Seals: Provide sleeves and seals of types, sizes and materials indicated, with the following construction features:
1. U Channel Strut Systems: Provide U channel strut system for supporting electrical equipment, 12-gauge stainless steel, of types and sizes indicated; construct with 9/16-inch dia. holes, 8-inch on center on top surface, and with fittings which mate and match with U channel.
 2. Manufacturers: Subject to compliance with requirements, provide channel systems of one of the following:
 - a. Allied Tube and Conduit Corp.
 - b. B Line Systems, Inc.
 - c. Greenfield Mfg. Co., Inc.
 - d. Midland Ross Corp.
 - e. OZ/Gedney Div.; General Signal Corp.
 - f. Power Strut Div.; Van Huffel Tube Corp.
 - g. Unistrut Div.; GTE Products Corp.

PART 3 - EXECUTION

3.01 INSTALLATION OF SUPPORTING DEVICES

- A. Coordinate with other electrical work, including raceway and wiring work, as necessary to interface installation of supporting devices with other work.

END OF SECTION

THIS PAGE LEFT BLANK INTENTIONALLY

SECTION 16195
ELECTRICAL IDENTIFICATION

PART 1 - GENERAL

1.01 RELATED DOCUMENTS

- A. Drawings and general provisions of Contract, including General and Supplementary Conditions and Division 1 Specification sections, apply to work of this Section.
- B. Division 16 Basic Electrical Materials and Methods section apply to work specified in this Section.

1.02 DESCRIPTION OF WORK

- A. Extent of electrical identification work is indicated by drawings and schedules.
- B. Work described in this Section includes furnishing all labor, materials, equipment, tools and incidentals required for identification of electrical materials, equipment, and installations. All equipment shall be installed, adjusted, tested and placed in operation in accordance with these Specifications, the manufacturer's recommendations and as shown on the Drawings.

Types of electrical identification work specified in this Section include the following:

- 1. Electrical power, control and communication conductors
- 2. Operational instructions and warnings
- 3. Danger signs
- 4. Equipment/system identification signs

1.03 QUALITY ASSURANCE

- A. Manufacturers: Firms shall have sufficient experience in the manufacture of electrical identification products of types required, for quality and successful manufacture of electrical identification products for this Project.
- B. NFPA-70 Compliance: Comply with NFPA-70 as applicable to installation of identifying labels and markers for wiring and equipment.
- C. UL Compliance: Comply with applicable requirements of UL Standard 969, "Marking and Labeling Systems" pertaining to electrical identification systems.

- D. NEMA Compliance: Comply with applicable requirements of NEMA Standard Publication Numbers WC 1 and WC 2 pertaining to identification of power and control conductors.
- E. Listing and Labeling: provide disconnect switches specified in this Section that are listed and labeled.
 - 1. The Terms "Listed" and "Labeled." As defined in the National Electrical Code, Article 100.
 - 2. Listing and Labeling Agency Qualifications: A "Nationally Recognized Testing Laboratory" (NRTL) as defined in OSHA Regulation 1910.7.

1.04 SHOP DRAWINGS AND SUBMITTALS

- A. Submittals shall be submitted to the County/Professional for review and acceptance prior to construction in accordance with the General Conditions and specifications Section 01300 "Submittals."
- B. Product Data: Submit manufacturer's data on electrical identification materials and products.
- C. Samples: Submit samples of each color, lettering style and other graphic representation required for each identification material or system.
- D. A copy of this specification section with addendum updates included, and all referenced and applicable sections with addendum updates included, with each paragraph check-marked to indicate specification compliance or marked to indicate requested deviations from specification requirements. Check marks shall denote full compliance with a paragraph as a whole.
- E. If deviations from the specifications are indicated, and therefore requested by the Contractor, each deviation shall be underlined and denoted by a number in the margin to the right of the identified paragraph, referenced to a detailed written explanation of the reasons for requesting the deviation.
- F. The County shall be the final authority for determining acceptability of requested deviations. The remaining portions of the paragraph not underlined will signify compliance on the part of the Contractor with the specifications.
- G. Failure to include a copy of the marked-up specification sections, along with justification(s) for any requested deviations to the specification requirements, with the submittal shall be sufficient cause for rejection of the entire submittal with no further consideration.

PART 2 - PRODUCTS

2.01 GENERAL

- A. All material supplied shall be one of the products specified in Appendix D "List of Approved Products" appended to these technical specifications.

2.02 ACCEPTABLE MANUFACTURERS

- A. Manufacturers: Subject to compliance with requirements, provide electrical identification products of one of the following (for each type marker):
 1. Alarm Supply Co., Inc.
 2. American Labelmark Co., Labelmaster Subsidiary
 3. Brady, W.H. Co.
 4. Calpico Inc.
 5. Carlton Industries, Inc.
 6. Champion American, Inc.
 7. Cole Flex Corp.
 8. Direct Safety Co.
 9. George Ingraham Corp.
 10. Griffolyn Co.
 11. Ideal Industries, Inc.
 12. LEM Products, Inc.
 13. Markal Co.
 14. National Band and Tag Co.
 15. Panduit Corp.
 16. Seton Name Plate Co.
 17. Standard Signs, Inc.
 18. Tesa Corp.

2.03 ELECTRICAL IDENTIFICATION MATERIALS

- A. General: Except as otherwise indicated provide manufacturer's standard product of categories and types required for each application. Where more than single type is specified for an application, selection is Installer's option, but provides single selection for each application.
- B. Color Coded Plastic Tape
 1. General: Provide manufacturer's standard self-adhesive vinyl tape not less than 3-mil thick by 1-1/2-inches wide.
- C. Cable/Conductor Identification Bands
 1. General: Provide manufacturer's standard vinyl cloth self adhesive cable/conductor markers of wrap around type, either pre-numbered plastic coated type, or write on type with clear plastic self adhesive cover flap; numbered to show circuit identification.

D. Baked Enamel Danger Signs

1. General: Provide manufacturer's standard "DANGER" signs of baked enamel finish on 20-gauge steel, of standard red, black, and white graphics; 14-inches by 10-inches size except where 10-inches by 7-inches is the largest size which can be applied where needed, and except where larger size is needed for adequate vision; with recognized standard explanation wording, e.g., HIGH VOLTAGE, KEEP AWAY, BURIED CABLE, DO NOT TOUCH SWITCH.

E. Engraved Plastic Laminate Signs

1. General: Provide engraving stock melamine plastic laminate lamicoïd-type engraved nameplates, complying with FS L P 387, in sizes and thickness indicated, engraved with engraver's standard letter style of sizes and wording indicated, black face and white core plies (letter color) except as otherwise indicated, punched for mechanical fastening except where adhesive mounting is necessary because of substrate.
2. Thickness: 1/8-inch except as otherwise indicated.
3. Fasteners: Self-tapping stainless steel screws, except contact type permanent adhesive where screws cannot or should not penetrate substrate.

2.04 LETTERING AND GRAPHICS

- A. General: Coordinate names, abbreviations and other designations used in electrical identification work with corresponding designations shown, specified or scheduled. Provide numbers, lettering and wording as indicated or, if not otherwise indicated, as recommended by manufacturer or as required for proper identification and operation/maintenance of electrical system and equipment. Comply with ANSI A13.1 pertaining to minimum sizes for letters and numbers.

PART 3 - EXECUTION

3.01 APPLICATION AND INSTALLATION

A. General Installation Requirements

1. Install electrical identification products as indicated, in accordance with manufacturer's written instructions, and requirements of NFPA-70.
2. Coordination: Where identification is to be applied to surfaces which require finish, install identification after completion of painting.
3. Regulations: Comply with governing regulations and requests of governing authorities for identification of electrical work.

B. Conduit Identification

1. General: Where electrical conduit is exposed in spaces with exposed mechanical piping which is identified by color-coded method, apply color-coded identification on electrical conduit in manner similar to piping identification. Except as otherwise indicated use white as coded color for conduit.

C. Cable/Conductor Identification

1. General: Apply cable/conductor identification, including voltage, phase and feeder number, on each cable/conductor in each box/enclosure/cabinet where wires of more than one circuit or communication/signal system are present, except where another form of identification (such as color-coded conductors) is provided. Match identification with marking system used in panel boards, shop drawings, contract documents, and similar previously established identification for project's electrical work.
2. Color-Code Conductors: Secondary service, feeder, and branch circuit conductors throughout the secondary electrical system.
3. 208/120 Volt System: As follows:
 - a. Phase A: Black
 - b. Phase B: Red
 - c. Phase C: Blue
 - d. Neutral: White
 - e. Ground: Green
 - f. 480/277 Volt System: As follows:
 - g. Phase A: Brown
 - h. Phase B: Orange
 - i. Phase C: Yellow
 - j. Neutral: Gray
 - k. Ground: Green

D. Operational Identification and Warnings

1. General: Wherever reasonably required to ensure safe and efficient operation and maintenance of electrical systems, and electrically connected mechanical systems and general systems and equipment, including prevention of misuse of electrical facilities by unauthorized personnel, install self adhesive plastic signs or similar equivalent identification, instruction or warnings on switches, outlets, and other controls, devices and covers of electrical enclosures. Where detailed instructions or explanations are needed, provide plasticized tags with clearly written messages adequate for intended purposes.

E. Danger Signs

1. General: In addition to installation of danger signs required by governing regulations and authorities, install appropriate danger signs at locations indicated and at locations subsequently identified by Installer of electrical work as constituting similar dangers for persons in or about project.
2. High Voltage: Install danger signs wherever it is possible under any circumstances, for persons to come into contact with electrical power of voltages higher than 110 120 volts.

F. Equipment/Systems Identification

1. General: Install engraved plastic laminate signs on each major unit of electrical equipment in building; including central or master unit of each electrical system including communication/ control/signal systems, unless unit is specified with its own self-explanatory identification or signal system. Except as otherwise indicated, provide single line of text, 1/2-inch high lettering on 1-1/2-inch high sign (2-inches high where 2 lines are required), white lettering in black field. Provide text matching terminology and numbering of the Contract documents and Shop Drawings. Provide signs for each unit of the following categories of electrical work:
 - a. Electrical cabinets and enclosures
 - b. Access panel/doors to electrical facilities
 - c. Disconnect devices

- G. Install signs at locations indicated or, where not otherwise indicated, at location for best convenience of viewing without interference with operation and maintenance of equipment. Secure to substrate with fasteners, except use adhesive where fasteners should not or cannot penetrate substrate.

END OF SECTION

SECTION 16420
SERVICE ENTRANCE

PART 1 - GENERAL

1.01 RELATED DOCUMENTS

- A. Drawing and general provisions of Contract, including General and Supplementary Conditions and Division 1 Specifications sections, apply to work of this Section.

1.02 DESCRIPTION OF WORK

- A. Extent of service entrance work is indicated by drawings and schedules.
- B. Work described in this Section includes furnishing all labor, materials, equipment, tools and incidentals required for a complete installation of all electrical service entrance. All equipment shall be installed, adjusted, tested and placed in operation in accordance with these Specifications, the manufacturer's recommendations and as shown on the Drawings.

Types of service entrance equipment in this Section include the following:

- 1. Main Circuit Breaker and Surge Protector

- C. Refer to other Division 16 sections for wires/cables, raceways, and electrical boxes and fittings work required in connection with service entrance equipment; not work of this Section.

1.03 QUALITY ASSURANCE

- A. Manufacturers: Firms shall have sufficient experience in the manufacture of service entrance equipment of types, sizes and ratings required, for quality and successful manufacture of service entrance equipment for use in this Project.
- B. Installer's Qualifications: Firms shall have sufficient experience to allow for quality and successful installation of service entrance equipment required for this Project.
- C. NFPA-70 Compliance: Comply with NFPA-70 as applicable to construction and installation of service entrance equipment and accessories.
- D. NEMA Compliance: Comply with construction and installation requirements of the following NEMA standards for service entrance equipment and accessories:
 - 1. Standard Publication Number AB 1; Molded Case Circuit Breakers
- E. UL Compliance: Comply with construction and installation requirements of the following UL standards for service entrance equipment and accessories:
 - 1. UL 50; Electrical Cabinets and Boxes
 - 2. UL 869; Electrical Service Equipment

3. UL 1449: Transient Voltage Surge Suppressors, revised Edition, July 2, 1997
- F. Provide service entrance equipment, and accessories which are UL listed and labeled, and marked "SUITABLE FOR USE AS SERVICE EQUIPMENT."
- G. IEEE Compliance: Comply with applicable requirements of IEEE Standard 241 pertaining to service entrances.
- H. Listing and Labeling: provide disconnect switches specified in this Section that are listed and labeled.
 1. The Terms "Listed" and "Labeled." As defined in the National Electrical Code, Article 100.
 2. Listing and Labeling Agency Qualifications: A "Nationally Recognized Testing Laboratory" (NRTL) as defined in OSHA Regulation 1910.7.

1.04 SHOP DRAWINGS AND SUBMITTALS

- A. Submittals shall be submitted to the County/Professional for review and acceptance prior to construction in accordance with the General Conditions and specifications Section 01300 "Submittals."
- B. Product Data: Submit manufacturer's data on service entrance equipment and accessories.
- C. Shop Drawings: Submit dimensioned layouts of service entrance equipment, including spatial relationship to proximate electrical equipment.
- D. A copy of this specification section with addendum updates included, and all referenced and applicable sections with addendum updates included, with each paragraph check-marked to indicate specification compliance or marked to indicate requested deviations from specification requirements. Check marks shall denote full compliance with a paragraph as a whole.
- E. If deviations from the specifications are indicated, and therefore requested by the Contractor, each deviation shall be underlined and denoted by a number in the margin to the right of the identified paragraph, referenced to a detailed written explanation of the reasons for requesting the deviation.
- F. The County shall be the final authority for determining acceptability of requested deviations. The remaining portions of the paragraph not underlined will signify compliance on the part of the Contractor with the specifications.
- G. Failure to include a copy of the marked-up specification sections, along with justification(s) for any requested deviations to the specification requirements with the submittal shall be sufficient cause for rejection of the entire submittal with no further consideration.

PART 2 - PRODUCTS

2.01 GENERAL

- A. All material supplied shall be one of the products specified in Appendix D "List of Approved Products" appended to these technical specifications.

2.02 SERVICE ENTRANCE EQUIPMENT

- A. General: Provide service entrance equipment and accessories; of types, sizes, ratings, and electrical characteristics indicated, which comply with manufacturer's standard materials, design and construction in accordance with published product information, and as required for complete installation; and as herein specified.
- B. Over Current Protection Devices
 - 1. General: Provide over current protective devices complying with Section 16180 "Over Current Protective Devices."
- C. Cable/Wire
 - 1. General: Provide cable/wire complying with Section 16120 "Wires and Cables."
- D. Raceways
 - 1. General: Provide raceways complying with Section 16110 "Raceways."
- E. Surge Protection Devices (SP's)
 - 1. Provide surge protection device in accordance with the following requirements:
 - a. Comply with UL 1449 and 1283, current Edition and IEEE 62.41, 62.45.
 - b. Units shall be listed and labeled as meeting requirements of UL 1449 current Edition. The unit shall meet "Testing Requirements" of IEEE 62.41 and 62.45.
 - c. Provide SPD redundant modules providing with phase to phase, phase to neutral phase to ground and neutral to ground protection as applicable for service voltage.
 - d. Provide front panel alarm and test switch and redundant LED indicators to indicate alarm and/or normal operating conditions.
 - e. Provide SPD with AC tracking filter with EMI/RKI filtering up to - 50dB from 100K Hz to 100 MHz.
 - f. UL suppression voltage rating (240/480 volt rating).

L-N	L-G	N-G	L-L
400/800	400/800	400	800
 - g. SPD unit to match station available voltage and phase.
 - h. Minimum Amperes per Mode Suppression 80,000. For Master Stations (4 or more pumps) or where level control of pump station is provided using Variable Frequency Drives (VFD's,) provide minimum Amperes per Mode Suppression of 150,000.
 - i. Comply with MIL Standard 220A Method of Insertion Loss Measurement

- j. NFPA-70 (NEC), National Electrical Code – Surge Protective Device Installation Practice and Grounding
 - k. ANSI/IEEE C62.41 and C62.45,
 - l. UL 67 and UL 891
 - m. Provide optional NEMA 4X enclosure and internal fusing/overload protection. Plastic NEMA 4X enclosures are acceptable for Surge Protection Devices in lieu of Stainless Steel.
2. Warranty: Minimum 10-year unlimited module replacement.
 3. Approved products: (See Appendix D "List of Approved Products")

2.03 SERVICE ENTRANCE ACCESSORIES

- A. Wall and Floor Seals: Provide wall and floor seals complying with Section 16190 "Supporting Devices" in accordance with the following listing:
 1. Wall and Floor Seals

PART 3 - EXECUTION

3.01 INSTALLATION OF SERVICE ENTRANCE EQUIPMENT

- A. Install service entrance equipment as indicated, in accordance with equipment manufacturer's written instructions, and with recognized industry practices, to ensure that service entrance equipment fulfills requirements. Comply with applicable installation requirements of NFPA-70 and NEMA standards.
- B. Coordinate with other electrical work, including utility company wiring, as necessary to interface installation of service entrance equipment work with other work.

3.02 GROUNDING

- A. Provide equipment bonding and grounding connectors, sufficiently tight to assure a permanent and effective ground, for service entrance equipment and wiring/cablings as indicated.

3.03 SURGE PROTECTION DEVICE (SPD)

- A. Install Surge Protection Device so leads are maintained at minimum length and minimum number of bends.
- B. Install Surge Protection Device on the load side of the main disconnect using split bolt connectors.
- C. All Surge Protection Devices (SPD's) shall be UL approved or NRTL approved to UL standards, and installed per respective power company requirements and manufacturer's specifications.
- D. Surge Protection Device shall be attached to the load side of the station main disconnect and be mounted in a separate NEMA 4X enclosure.

3.04 ADJUST AND CLEAN

- A. Adjust operating mechanisms for free mechanical movement.
- B. Touch up scratched or marred enclosure surfaces to match original finishes.

3.05 FIELD QUALITY CONTROL

- A. Upon completion of installation of service entrance equipment and electrical circuitry, energize circuitry and demonstrate capability and compliance with requirements. Where possible, correct malfunctioning units at site, then retest to demonstrate compliance; otherwise, remove and replace with new units, and retest.

END OF SECTION

THIS PAGE LEFT BLANK INTENTIONALLY

SECTION 16450

GROUNDING

PART 1 - GENERAL

1.01 RELATED DOCUMENTS

- A. Drawings and general provisions of Contract, including General and Supplementary Conditions and Division 1 Specification sections, apply to work of this Section.

1.02 DESCRIPTION OF WORK

- A. Extent of grounding work is indicated by drawings and schedules. This Section specifies the system for grounding electrical distribution and utilization equipment cabinets, motor frames, manholes, instrumentation, metal surfaces of process/mechanical equipment that contain energized electrical components, metal structures and buildings, outdoor metal enclosures, fences and gates. This Section also includes grounding of electrical systems and equipment and basic requirements for grounding for protection of life, equipment, circuits, and systems. Grounding requirements specified in this Section may be supplemented in other Sections of these Specifications.
- B. Work described in this Section includes furnishing all labor, materials, equipment, tools and incidentals required for a complete installation of grounding system. All work shall be installed, adjusted and tested in accordance with these Specifications, the manufacturer's recommendations and as shown on the Drawings. Types of grounding specified in this Section include the following:
 - 1. Solid Grounding
- C. Applications of grounding work in this Section include the following:
 - 1. Underground metal water piping
 - 2. Grounding electrodes
 - 3. Grounding rods
 - 4. Service equipment
 - 5. Enclosures
 - 6. Equipment
 - 7. Fences and gates

1.03 QUALITY ASSURANCE

- A. Manufacturers: Firms shall have sufficient experience in the manufacture of electrical connectors, terminals and fittings, of types and ratings required, and ancillary grounding materials, including stranded cables, copper braid and bus, ground rods and plate electrodes, for manufacture of grounding equipment for use in this Project.

- B. Installer: Firms shall have sufficient experience to allow for quality and successful installation of grounding equipment for this Project.
- C. NFPA-70 Compliance: Comply with NFPA-70 requirements as applicable to materials and installation of electrical grounding systems, associated equipment and wiring. Provide grounding products which are UL listed and labeled.
- D. UL Compliance: Comply with applicable requirements of UL Standards Numbers 467 and 869 pertaining to electrical grounding and bonding.
- E. IEEE Compliance: Comply with applicable requirements of IEEE Standard 81, 142 and 241 pertaining to electrical grounding.
- F. NETA Compliance: Comply with the International Electrical Testing Association, Inc. Acceptance Testing Specifications.
- G. Testing Agency Qualifications: A "Nationally Recognized Testing Laboratory" (NRTL) as defined in OSHA Regulation 1910.7, or a full member company of the international Electrical Testing Association (NETA).
 - 1. Testing Agency Field Supervision: Use persons currently certified by NETA or the National Institute for Certification in Engineering Technologies to supervise on-site testing specified in Part 3.
- H. Comply with NFPA 70.
- I. Comply with UL 467.
- J. Listing and Labeling: Provide products specified in this Section that are listed and labeled.
 - 1. The Terms "Listed" and "Labeled." As defined in the National Electrical Code, Article 100.
 - 2. Listing and Labeling Agency Qualifications: A "Nationally Recognized Testing Laboratory" (NRTL) as defined in OSHA Regulation 1910.7.
- K. See also Section 16010 Part 1 for listing of applicable reference standards.

1.04 SHOP DRAWINGS AND SUBMITTALS

- A. Submittals shall be submitted to the County/Professional for review and acceptance prior to construction in accordance with the General Conditions and specifications Section 01300 "Submittals."
- B. Product Data: Submit manufacturer's data on grounding systems and accessories.
- C. A copy of this specification section with addendum updates included, and all referenced and applicable sections with addendum updates included, with each paragraph check-marked to indicate specification compliance or marked to indicate requested deviations from specification requirements. Check marks shall denote full compliance with a paragraph as a whole.

- D. If deviations from the specifications are indicated, and therefore requested by the Contractor, each deviation shall be underlined and denoted by a number in the margin to the right of the identified paragraph, referenced to a detailed written explanation of the reasons for requesting the deviation.
- E. The County shall be the final authority for determining acceptability of requested deviations. The remaining portions of the paragraph not underlined will signify compliance on the part of the Contractor with the specifications.
- F. Failure to include a copy of the marked-up specification sections along with justification(s) for any requested deviations to the specification requirements, with the submittal shall be sufficient cause for rejection of the entire submittal with no further consideration.

PART 2 - PRODUCTS

2.01 GENERAL

- A. All material supplied shall be one of the products specified in Appendix D "List of Approved Products" appended to these technical specifications.

2.02 ACCEPTABLE MANUFACTURERS

- A. Manufacturers: Subject to compliance with requirements, provide grounding products of one of the following:
 - 1. Apache Grounding; Nashville Wire Products
 - 2. Chance: A. B. Chance Co.
 - 3. B-Line Systems, Inc.
 - 4. Burndy Corp.
 - 5. Crouse-Hinds Co.
 - 6. Electrical Components Div.; Grould, Inc.
 - 7. Galvan Industries, Inc.
 - 8. General Electric Supply Co.
 - 9. Hastings Fiber Glass Products, Inc.
 - 10. Heary Brothers Lightning Protection Co.
 - 11. Kearney
 - 12. Ideal Industries, Inc.
 - 13. Lightning Master Corp.
 - 14. Lyncole XIT Grounding.
 - 15. O-Z/Gedney Co.
 - 16. Raco, Inc.
 - 17. Thomas and Betts Corp.

2.03 GROUNDING SYSTEMS

A. Materials and Components

1. General: Except as otherwise indicated, provide electrical grounding systems indicated; with assembly of materials, including, but not limited to, cables/wires, connectors, terminals (solderless lugs), grounding rods/electrodes, and plate electrodes, bonding jumper braid, surge arrestors, and additional accessories needed for complete installation. Where more than one type unit meets indicated requirements, selection is Installer's option. Where materials or components are not indicated, provide products complying with NFPA-70, UL, IEEE, and established industry standards for applications indicated.
2. Governing Requirements: Where types, sizes, ratings, and quantities indicated are in excess of National Electrical Code (NEC) requirements, the more stringent requirement and the greater size, rating, and quantity indications shown shall be adhered.
3. A counterpoise cable grounding system installed a minimum of 30-inches below grade, shall be installed with connections to at least the following equipment:
 - a. Wetwell cover
 - b. Valve vault cover
 - c. Control panels
 - d. Generator
 - e. Electrical system grounding electrode conductor
 - f. Main disconnect switch
 - g. Fence
 - h. Emergency bypass piping and station back flow preventer and water spigot to be bonded
 - i. Exception: Ground connection to fencing is not required for PVC coated chain link fence framing, concrete block wall, or wood fencing.
4. Provide raceways, and electrical boxes and fittings complying with accordance with the following listing:
 - a. PVC conduit
 - b. PVC conduit fittings
 - c. Liquid-tight flexible metal conduit
 - d. Liquid-tight flexible metal conduit fittings
 - e. Rigid aluminum conduit
 - f. Rigid aluminum conduit fittings

B. Conductors: Unless otherwise indicated, provide electrical grounding conductors for grounding connections matching power supply wiring materials and sized according to NFPA-70.

C. Ground Rods: Steel with copper welded exterior, 3/4-inch dia. x 10-feet.

D. Electrical Grounding Connection Accessories: Provide electrical insulating tape, heat-shrinkable insulating tubing, welding materials, bonding straps, as recommended by accessories manufacturers for type services indicated.

E. Comply with Division 16 Section 16120 "Wires and Cables." Conform the NEC Table 8, except as otherwise indicated, for conductor properties, including stranding.

- F. Equipment Grounding Conductors: Insulated copper with green color insulation.
- G. Grounding-Electrode Conductors: Stranded copper cable.
- H. Underground Conductors: Bare and stranded copper.
- I. Bare Copper Conductors: Conform to the following:
 - 1. Solid Conductors: ASTM B3
 - 2. Assembly of Stranded conductors: ASTM B8
- J. Ground cable shall be soft-drawn, bare annealed copper, concentric stranded, as specified.
- K. The minimum sizes shall be as follows, where American Wire Gauge (AWG) cable sizes are not shown or specified:

5 and 15 kV switchgear	2/0 or 4/0 AWG
5 kV motor starters	2/0 or 4/0 AWG
15 kV-5 kV transformers	2/0 or 4/0 AWG
5 kV-480V transformers	2/0 or 4/0 AWG
480V switchgear	2/0 or 4/0 AWG
480V switchboards	2/0 or 4/0 AWG
480V MCC and	2/0 or 4/0 AWG
Cable tray	2/0 or 4/0 AWG
Large motors 250 hp & >	2/0 or 4/0 AWG
Lighting & Power panels	2 AWG
Exposed metal cabinets	2 AWG
Electrical equipment	2 AWG
Buildings and enclosure	2 AWG
Fences and gates	2 AWG
Motors 25 hp to 250 hp	2 AWG
Motors 1 hp to 25 hp	6 AWG
- L. Grounding Bus: Bare, annealed copper bars of rectangular cross section.
- M. Braided Bonding Jumpers: Copper tape, braided Number 3/0 AWG bare copper wire, terminated with copper ferrules.
- N. Bonding straps: Soft copper, 0.05-inch (1-mm) thick and 2-inches (50-mm) wide, except as indicated.
- O. Compression connections shall be irreversible, cast copper, high conductivity as manufactured by Thomas and Betts, or equal.
- P. Bolted connectors shall be Burndy, O. Z. Gedney, or equal heavy-duty type.

- Q. Exothermic welding products shall be Erico's Cadweld Plus system with electronic ignition device and moisture resistant weld metal cup for the required mold, or equal. Connectors shall be provided in kit form and selected per manufacturer's written instructions for specific types, sizes, and combination of conductors and connected items.
- R. Provide concrete test well with cover and connect the ground grid extension using a removable connector.
- S. Copper equipment ground bars shall be Erico Eritech EGB Series or equal, sized as required for the installation.

PART 3 - EXECUTION

3.01 APPLICATION AND TESTING

- A. Contractor shall test ground rod to obtain a ground resistance value of less than 5 ohms.
- B. Maximum distance between counterpoise ground rods shall be 100-feet. Provide additional ground rods as required.
- C. Counterpoise shall be installed a minimum of 30-inches below grade.
- D. Tests: Before making connections to the ground electrode, measure the resistance of the electrode to ground using a ground resistance tester specifically designed for ground resistance testing. Perform the test not less than 2-days after the most recent rainfall, and in the afternoon after any ground condensation (dew) has evaporated. If a resistance less than the performance requirements is not obtained, provide a ground rod driven 6-inches below grade spaced 10-feet away from the ground well and connect to ground test well with Number 2/0 tinned stranded copper wire and repeat the test. If the performance requirements are still not obtained, inform the County for resolution. Testing results by a certified testing agency using fall of potential testing as described by NETA (International Electrical Testing Association).
- E. Provide a certified copy of the grounding test report to the County.
- F. Equipment grounding Conductors: Comply with NEC Article 250 for types, sizes, and quantities of equipment grounding conductors, except where specific types, larger sizes, or more conductors than required by NEC are indicated.
 - 1. Install equipment grounding conductor with circuit conductors for the items below in addition to those required by Code:
 - a. Feeders and branch circuits
 - b. Lighting circuits
 - c. Receptacle circuits
 - d. Single-phase motor or appliance branch circuits
 - e. Three-phase motor or appliance branch circuits
 - f. Flexible raceway runs

2. Metallic Raceways: Raceways, conduits and cable trays, etc. shall be made electrically continuous, and shall be bonded/grounded to earth. Utilize bonding/grounding wires, jumpers, clamps, etc. as necessary to meet requirements of NEC.
 3. Non-metallic Raceways: Install a grounding conductor in non-metallic raceways unless they are designated for telephone or data cables.
 4. Air-Duct Equipment Circuits: Install a grounding conductor to duct mounted electrical devices operating at 120 V and above, including air cleaners and heaters. Bond conductor to each unit and to air duct.
 5. Water Heater, Heat-Tracing, and Anti-frost Heater Circuits: Install a separate grounding conductor to each electric water heater, heat-tracing assembly, and anti-frost heating cable. Bond conductor to heater units, piping, connected equipment, and components.
- G. Signal and Communication Systems: For telephone, alarm, voice and data, and other communication systems, provide a Number 4 AWG minimum insulated grounding conductor from grounding-electrode system to each service location, backboard, terminal cabinet, wiring closet, and central equipment location.
1. Service and Central equipment Locations and wiring Closets: Terminate grounding conductor on a 1/4 by 2 by 12-inch (6 by 50 by 300-mm) grounding.
 2. Terminal Cabinets: Terminate grounding conductor on cabinet grounding terminal.
- H. Separately Derived Systems: Where NEC requires grounding, ground according to NEC.
- I. Metal Poles Supporting Lighting Fixtures: Ground pole to a grounding electrode in addition to separate equipment grounding conductor run with supply branch circuit.
- J. General: Ground electrical systems and equipment according to NEC requirements, except where Drawings or Specifications exceed NEC requirements.
- K. Grounding Electrode System: Where available on the premises, at each building or structure served, a metal underground water pipe, the metal frame of the building or structure, concrete encased electrodes, any ground ring encircling the building or structure and all made electrodes (ground rods, etc.) shall be bonded together to form the grounding electrode system. The main bonding jumper and the grounding electrode conductor shall be installed and sized per NEC except where larger sizes than required by NEC are indicated.
- L. Grounding Rods: A minimum of two (2) ground rods shall be installed where the ground rod serves as the grounding electrode per NEC. Locate a minimum of 1-rod length from each other and at least the same distance from any other grounding electrode.
1. Drive until tops are 2-inches (50-mm) below finished floor or final grade, except as otherwise indicated.
 2. Interconnect with grounding-electrode conductors except at test wells and as otherwise indicated. Use exothermic welds or irreversible compression connections. Make these connections without damaging copper coating or exposing steel.
- M. Grounding Conductors: Route along the shortest and straightest paths possible, except as otherwise indicated. Avoid obstructing access or placing conductors where they may be subjected to strain, impact, or damage.

- N. Grounding conductors, insulated and color coded green, shall be provided in all low voltage feeder and sub-feeder and branch circuit conduit runs, except low voltage service entrance conduit runs which contain a grounded neutral. These grounding conductors shall be connected to all metallic conduits by means of approved grounding bushings at all conduit terminations at the supply end of all feeders.
- O. General: Make connections so possibility of galvanic action or electrolysis is minimized. Select connectors, connection hardware, conductors, and connection methods so metals in direct contact will be galvanically compatible.
1. Use electroplated or tin-coated materials to assure high conductivity and to make contact points closer in order of galvanic series.
 2. Make connections with clean, bare metal at points of contact.
 3. Make aluminum-to-steel connections with stainless steel separators and mechanical clamps.
 4. Make aluminum-to-galvanized steel with tin-plated copper jumpers and mechanical clamps.
 5. Coat and seal connections having dissimilar metals with inert material to prevent future penetration of moisture to contact surfaces.
- P. Exothermic-Welded Connections: Use for connections to structural steel and for underground connections, except those at test wells. Comply with manufacturer written instructions. Welds that are puffed up or that show convex surfaces indicating improper cleaning are not acceptable. Irreversible compression connections may be acceptable as an alternate method.
- Q. Equipment Grounding-Wire Terminations: For Number 8 AWG and larger, use pressure-type grounding lugs. Number 10 AWG and smaller grounding conductors may be terminated with winged pressure-type connectors.
- R. Non-contact metal Raceway Terminations: Where metallic raceways terminate at metal housings without mechanical and electrical connection to housing, terminate each conduit with a grounding bushing. Connect grounding bushings with a bare grounding conductor to grounding bus or terminal in housing. Bond electrically non-continuous conduits at both entrances and exits with the grounding conductors, except as otherwise indicated.
- S. Connections at Test Wells: Use compression-type connectors on conductors and make bolted and clamped-type connections between conductors and grounding rods.
- T. Tighten screws and bolts for grounding and bonding connectors and terminals according to manufacturer's published torque-tightening values. Where these requirements are not available, use those specified in UL 486A and UL 486B.
- U. Compression-Type Connections: Use hydraulic compression tools to provide correct circumferential pressure for compression connectors. Use tools and dies recommended by manufacturer of connectors. Provide embossing die code or other standard method to make a visible indication that a connector has been adequately compressed on grounding conductor.

END OF SECTION

R&R PACKAGE 1 PUMP STATION IMPROVEMENTS
University at Rouse PS #3365, Lena Street PS #3309, Allison Oaks PS #3893, Greenview
Pines PS #3887 and Bradford Cove PS #3890

TECHNICAL SPECIFICATIONS

Table of Contents

DIVISION 1 – GENERAL REQUIREMENTS

01001	General Work Requirements
01010	Summary of Work
01021	Soils Report and Other Information
01025	Measurement and Payment
01027	Applications for Payment
01050	Surveying and Field Engineering
01065	Permits and Fees
01070	Abbreviations and Symbols
01091	Reference Specifications
01200	Project Meetings
01300	Submittals
01310	Progress Schedules
01370	Schedule of Values
01380	Audio-Visual Documentation
01400	Quality Control
01410	Testing and Laboratory Services
01516	Collection System Bypass
01560	Erosion and Sedimentation Control
01570	Maintenance of Traffic
01580	Project Identification and Signs
01590	Construction Field Office
01610	Delivery Storage and Handling
01650	Pump Station Start-Up and Testing
01700	Project Closeout
01720	Project Record Documents
01730	Pump Station Operation and Maintenance Manual
01740	Warranties and Bonds

DIVISION 2 – SITE WORK

02050	Demolition of Existing Structures
02080	Abandonment, Removal, and Salvage or Disposal of Existing Pipe
02100	Temporary Erosion and Sedimentation Control
02140	Dewatering
02215	Finish Grading
02220	Excavating, Backfilling, and Compacting
02576	Concrete Sidewalks and Driveways
02578	Solid Sodding

R&R PACKAGE 1 PUMP STATION IMPROVEMENTS
University at Rouse PS #3365, Lena Street PS #3309, Allison Oaks PS #3893, Greenview
Pines PS #3887 and Bradford Cove PS #3890

TECHNICAL SPECIFICATIONS

Table of Contents

DIVISION 2 (CONTINUED)

02661	Wastewater Force Mains
02761	Cleaning Sanitary Sewer Systems
02762	Televising Sanitary Sewer Systems
02771	Cure-in-Place Pipe for Sanitary Sewer Renewal
02774	Wastewater Gravity Collection System
02775	Wastewater Manhole Rehabilitation
02784	Chain Link Fences and Gates

DIVISION 3 – CONCRETE

03100	Concrete Formwork
03200	Concrete Reinforcement
03300	Cast-in-Place Concrete
03410	Precast Concrete Structures
03600	Grouting

DIVISION 4 – MASONRY (NOT USED)

DIVISION 5 – METALS

05500	Miscellaneous Metals
-------	----------------------

DIVISION 6 – WOOD, PLASTICS AND COMPOSITES (NOT USED)

DIVISION 7 – THERMAL AND MOISTURE PROTECTION (NOT USED)

DIVISION 8 – OPENINGS

08350	Access Hatch Doors
-------	--------------------

DIVISION 9 – FINISHES

09901	Coatings and Linings
09905	Pump Station Valve Identification System
09960	High Performance Ferrous Metal Coatings

R&R PACKAGE 1 PUMP STATION IMPROVEMENTS
University at Rouse PS #3365, Lena Street PS #3309, Allison Oaks PS #3893, Greenview
Pines PS #3887 and Bradford Cove PS #3890

TECHNICAL SPECIFICATIONS

Table of Contents

DIVISION 10 – SPECIALTIES (NOT USED)

DIVISION 11 – EQUIPMENT

- 11305 Submersible Pumps and Appurtenances
- 11305-A Submersible Pump Schedule

DIVISION 12 – FURNISHING (NOT USED)

DIVISION 13 – SPECIAL CONSTRUCTION

- 13423 Level Measurement
- 13430 Pump Station Control Panels

DIVISION 14 – CONVEYING EQUIPMENT (NOT USED)

DIVISION 15 – MECHANICAL

- 15062 Ductile Iron Pipe and Fittings
- 15064 Polyvinyl Chloride (PVC) Pipe and Fittings
- 15065 Stainless Steel Pipe and Fittings
- 15100 Ancillary Equipment
- 15105 Check Valves
- 15110 Plug Valves

DIVISION 16 – ELECTRICAL

- 16010 Electrical General Provisions
- 16110 Raceways
- 16120 Wires and Cables
- 16135 Electrical Boxes and Fittings
- 16142 Electrical Connections for Equipment
- 16143 Wiring Devices
- 16170 Circuit and Motor Disconnects
- 16180 Over Current Protective Devices
- 16190 Supporting Devices
- 16195 Electrical Identification
- 16420 Service Entrance
- 16450 Grounding

R&R PACKAGE 1 PUMP STATION IMPROVEMENTS
University at Rouse PS #3365, Lena Street PS #3309, Allison Oaks PS #3893, Greenview
Pines PS #3887 and Bradford Cove PS #3890

TECHNICAL SPECIFICATIONS

Table of Contents

APPENDICES

APPENDIX A	GEOTECHNICAL REPORT
Appendix A	Geotechnical Investigation Report prepared by Antillian Engineering Associates, Inc.
Appendix A	Groundwater Sampling and Laboratory Screening Results for Pump Station 3365 and 3309 by BFA, Inc.
APPENDIX B	FORMS
Appendix B	Digital Data Submission
Appendix B	Pressure Test
Appendix B	Pump Station Start-Up Report
APPENDIX C	PERMITS OBTAINED BY COUNTY
APPENDIX D	LIST OF APPROVED PRODUCTS
Appendix D	Orange County Utilities – List of Approved Products (February 11, 2011)
APPENDIX E	BOUNDARY SURVEYS
Appendix E	Boundary and Topographic Survey PS #3365
Appendix E	Boundary and Topographic Survey PS # 3309
Appendix E	Proposed Boundary and Easement Survey PS #3365
Appendix E	Proposed Boundary and Easement Survey PS #3309
APPENDIX G	DEWATERING DISCHARGE OFF-SITE
Appendix G	FDEP Notice of New Method for Mercury Testing
Appendix G	FDEP Generic Permit for the Discharge of Produced Groundwater
Appendix G	Memo – EPA – Analytical Methods for Mercury in NPDES Permits
Appendix G	Orange County EPD Work Instruction

APPENDIX A

GEOTECHNICAL REPORT

The attached Geotechnical Engineering Investigation and dewatering ground water sampling was accomplished for the utilization of the Design Engineer during the design phases of this project. The criteria and recommendations stated herein are not to be construed as direction from the Design Engineer to the Contractor and are hereby provided only as general information, furnished as a courtesy to the Contractor.

**GEOTECHNICAL INVESTIGATION REPORT
ORANGE COUNTY UTILITIES PACKAGE 1
PUMP STATION REHABILITATION
PUMP STATION 3309 and PUMP STATION 3365
ORANGE COUNTY, FLORIDA**

AEA PROJECT No. 201112-4

Antillian Engineering Associates, Inc.
3331 Bartlett Boulevard
Orlando, Florida 32811
(407) 422-1441



November 19, 2012

BFA Environmental, Inc.
1230 East Hillcrest Street
Orlando, Florida 32803

Attention: Geoff Hennessy, P.E.

Reference: Geotechnical Investigation Report
Orange County Utilities Package 1
Pump Station Rehabilitation
Pump Station 3309 and Pump Station 3365
Orange County, Florida
AEA Project No. 201112-4

Dear Mr. Hennessy:

Antillian Engineering Associates, Inc. has completed the geotechnical engineering investigation for the proposed rehabilitations of Pump Station 3309 and Pump Station 3365 in eastern Orange County, Florida. The work on this project was authorized under Orange County Utilities Continuing Utilities Engineering Contract Y11-902A. It was done in general accordance with the scope of services presented in our proposal dated March 28, 2012. This report contains the results of our investigations, our recommendations for pump station design and construction, earthwork, groundwater control and other concerns as appropriate.

It has been our pleasure to serve BFA Environmental, Inc. and Orange County Utilities on this project. Please do not hesitate to call if you have any questions or if you need additional information.

Very truly yours,

ANTILLIAN ENGINEERING ASSOCIATES, INC.

State of Florida Authorization No. EPO008

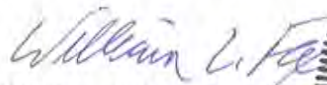
William L. Fox, P.E.
Geotechnical Engineer
Florida Registration No. 55385



Peter G. Suah, P.E.
Principal Engineer
Florida Registration No. 46910

Attachments: Figures
Appendix A: Field and Laboratory Investigations
Appendix B: Important Information About Your Geotechnical Engineering Report
Appendix C: Constraints and Restrictions

PROJECT DESCRIPTION

Orange County Utilities (OCU) is planning to rehabilitate two pump station sites in the eastern part of the county. Pump Station 3309 is situated on the southern side of Lena Street about 100 feet west of Percival Road. Pump Station 3365 is situated on the southern side of University Boulevard about 800 feet west of Rouse Road. The approximate locations of the pump station sites are shown on Figure 1. Although these two pump stations are more than three miles apart, OCU has combined them into a single package for design and construction.

Improvements at Pump Station 3309 (“PS 3309”) will include the demolition and removal of the existing concrete valve vault and replacement with a new precast concrete vault. The new structure will be installed at the same location as the existing structure and will be slightly larger in plan. It is expected to bear about five feet below grade near the same level as the existing vault. An existing valve vault at Pump Station 3365 (“PS 3365”) will also be demolished and removed but will not be replaced. New yard piping and replacement electrical panels are also planned for both sites.

It is our understanding that the existing wet wells at each site will be rehabilitated in lieu of replacement. Site grades are not expected to change.

AVAILABLE INFORMATION

The United States Geological Survey (USGS) quadrangle topographic map that covers both areas was reviewed to obtain general information about the project area. The USGS map showed the project vicinity surrounding PS 3309 as a level area located to the north and west of a low-lying area. Land usage was mapped as suburban and residential. Some of the existing streets in the vicinity were shown on the map. Ground surface elevations were mapped near the Elevation 55 feet NGVD (El. 55) contour. The project vicinity surrounding PS 3365 was shown as a level, comparatively low-lying area. Land usage was mapped as suburban to urban and like PS 3309, most of the existing streets in the vicinity were shown. Ground surface elevations were mapped near the El. 50 contour.

[END OF SECTION]

FIELD INVESTIGATION

A site reconnaissance was conducted at each pump station to prepare for the drilling program. Test boring locations were established in the field at locations accessible to the drill rig and were staked for underground utility location and marking as required by Florida Statutes.

A single test boring was drilled at each site on October 12, 2012. Boring B-3309 was drilled at PS 3309 and Boring B-3365 was drilled at PS 3365. Approximate locations are shown on Figure 2. Both borings were advanced to a depth of 30 feet by mud-rotary drilling. The Standard Penetration Test (SPT) with split-spoon sampling was conducted in accordance with ASTM D 1586. Sampler penetration resistance, expressed in hammer blows per foot (the "SPT N-value"), was used as an empirical indication of soil consistency.

The soils encountered during drilling were logged by the field crew. Representative samples were sealed in clean, airtight containers for transportation to our Orlando office. The stabilized depth to groundwater encountered in each boring was measured and recorded on the field logs. At the completion of the drilling program, the boreholes were backfilled to the ground surface with soil cuttings mixed with sand and bentonite chips.

LABORATORY TESTING

The recovered soil samples were examined in our office by a geotechnical engineer who confirmed the descriptions on the field logs, classified the soils visually and developed a representation of the soil stratigraphy at each boring location. Representative soil samples were selected for laboratory testing, which consisted of seven single-sieve gradation analyses, one organic content test, two natural moisture content tests and one series of Atterberg limits tests. The test results are presented on the boring logs and on the Summary of Laboratory Test Results sheet in Appendix A.

[END OF SECTION]

SURFACE CONDITIONS

Both sites were existing wastewater pump stations enclosed by locked chain-link fences. The ground surface at both sites was nearly level to level. The area within the fence at PS 3309 was covered with grass turf while PS 3365 was mostly paved with asphalt and concrete. Valve vaults, wet wells, electrical panels and piping were observed.

Both sites were adjacent to developed, single-family residential areas. Wet stormwater detention ponds were located adjacent to each site. The water surface was estimated to be about 12 feet below the ground surface in the pond at the PS 3309 site, while the water surface in the pond at the PS 3365 site was about four feet below the surrounding banks. Water depth could not be ascertained in either pond.

SUBSURFACE CONDITIONS

Pump Station 3309 (Boring B-3309)

The uppermost material in B-3309 was brown fine sand that appeared to contain small amounts of silt mixed with gravel and clayey sands. Its encountered thickness was about six feet. SPT N-values ranged from 7 blows per foot (bpf) to 13 bpf, indicating that the soils were loose to medium dense. Based on the observed variability in composition, consistency and color, these soils were classified visually as “possible fill”.

Beneath the possible fill was dark brownish gray fine sand that appeared to contain some silt. Its encountered thickness was about six feet. SPT N-values ranged from Weight of Hammer (“WOH”) to 8 bpf, indicating that the soils were very loose to loose. The SPT N-values were highest at the top of the layer and decreased with depth. Single-sieve gradation analysis of one sample indicated a fines content (fraction by dry weight passing the U.S. Standard No. 200 sieve size) of 12 percent which resulted in the Unified Soil Classification System (USCS) designation “SM” for silty sand.

Beneath the silty sand was gray fine sand that appeared to contain some clay. This soil exhibited a slightly plastic texture. Its encountered thickness was about two feet. The single SPT N-value recorded in this soil was 4 bpf, indicating that the soils were loose. Single-sieve gradation analysis of one sample indicated a fines content of 22 percent and resulted in the USCS designation “SC” for clayey sand.

Beneath the clayey sand was very light gray fine sand that appeared to contain a trace of silt. Its encountered thickness was about three feet. The single SPT N-value recorded in this soil was 11 bpf, indicating that the soils were medium dense. Visual classification of the sample resulted in the USCS designation “SP” for fine sand.

Beneath the fine sand was gray sand that appeared to contain clay. Its encountered thickness was about eight feet. SPT N-values were 10 bpf and 13 bpf, indicating that the soils were loose to medium dense. Single-sieve gradation analyses of two samples indicated fines contents of 15

percent and 38 percent. Additional testing on the sample with the higher fines content indicated natural moisture content of 34 percent, liquid limit of 27 and plasticity index of 9. The tests resulted in the USCS designation “SC”.

Beneath the clayey sand was grayish brown sand that appeared to contain some silt. Its encountered thickness was about six feet. Its actual thickness could not be confirmed because the boring was terminated in this material without penetrating it completely. The single SPT N-value was 18 bpf, indicating that the soils were medium dense. Visual classification of the sample resulted in the USCS designation “SP-SM” for sand with silt.

Groundwater was encountered in the borehole at B-3309 at a depth of about 12 feet below the existing ground surface. Details of the encountered subsurface characteristics are shown on the boring log and on the Summary of Laboratory Tests sheet in Appendix A.

Pump Station 3365 (Boring B-3365)

Pavement consisting of approximately three inches of asphalt on 15 inches of compacted, crushed limestone (“limerock”) base was encountered uppermost in boring B-3365. Beneath the pavement was brown, grayish brown, and dark brown fine sand that appeared to contain small amounts of silt. The encountered thickness of this material was about 12 feet. SPT N-values ranged from 11 bpf to 20 bpf, indicating that the soils were medium dense. Single-sieve gradation analyses of two samples indicated fines contents of 4 percent and 6 percent, which resulted in the USCS designations “SP” for fine sand and “SP-SM” for sand with silt.

Beneath the sand was dark brown fine sand that appeared to contain more silt and some organic material. Its encountered thickness was about five feet. The single SPT N-value recorded in this layer was 4 bpf, indicating that the soils were loose. Single-sieve gradation analysis of one sample indicated a fines content of 25 percent. Additional testing indicated a natural moisture content of 39 percent and organic content of 20 percent. The tests resulted in the USCS designation “SM” for silty sand with organic fines.

Beneath the silty fine sand with organic fines was dark grayish brown fine sand that appeared to contain less silt. Its encountered thickness was about 13 feet. The actual thickness could not be confirmed because the boring was terminated in this material without penetrating it completely. Trace to some wood and roots were observed in the samples obtained at 20 feet and 25 feet. SPT N-values ranged from 20 bpf to 32 bpf, indicating that the soils were medium dense to dense. Samples were classified visually and given the USCS designation “SP-SM”.

Groundwater was encountered in the borehole at B-3365 at a depth of about four feet below the existing ground surface. Details of the encountered subsurface characteristics are shown on the boring log and on the Summary of Laboratory Tests sheet in Appendix A.

GENERAL COMMENTS ON RECOMMENDATIONS

The following recommendations are based upon a review of the field and laboratory test data, our understanding of the proposed construction and our experience with similar projects and subsurface conditions. If plans for the proposed construction change from those discussed in this report, we request the opportunity to review our recommendations, and amend them as needed to accommodate those changes. In addition, if subsurface conditions encountered during construction differ significantly from those encountered in the borings, those conditions should be reported to us immediately for our observation and recommendations.

GENERAL ASSESSMENT OF ENCOUNTERED SOILS

As discussed in the SUBSURFACE CONDITIONS section of this report, the soils encountered during this investigation were mostly fine sands containing varying amounts of silt and clay. At PS 3309, loose to medium dense sandy soils occasionally containing gravel and clayey sands were encountered from the ground surface to a depth of about six feet. Loose to very loose sands were encountered beneath the fill to a depth of about 14 feet. At PS 3365, the asphalt pavement was underlain by medium dense sand to a depth of about 12 feet, followed by very loose, dark brown silty fine sand with organic fines to a depth of about 17 feet. Buried trash, debris or other objectionable materials were not encountered in the borings.

Generally speaking, the soil conditions discussed above should not significantly affect the proposed pump station improvements. The encountered soils at PS 3309 are suitable for supporting the proposed valve vault. Since that vault is expected to be similar in size and bearing depth to the existing vault, little to no additional loading and additional stress increase on underlying soils is anticipated. Therefore, total and differential settlements of the proposed structure beyond tolerable limits are not anticipated.

As discussed earlier, proposed improvements to PS 3365 include the demolition and removal of the existing below-grade concrete vault structure located near the northeast corner of the site adjacent to University Boulevard. The bottom of this existing structure is about eight feet below grade so the loose, silty sand with organic fines is not likely to be encountered during its removal. Further, we understand that the other proposed improvements do not include excavation to depths that would encounter the loose silty fine sand with organic fines, as encountered at B-3365, nor any new structures. No new loads on the soils are expected.

VALVE VAULT DESIGN

The increase in vertical pressure induced in the soil beneath an embedded structure by the total weight on its foundation (the “contact pressure” or “gross bearing pressure”) is reduced by the soil pressure that existed at the bearing level prior to foundation excavation (the “overburden” pressure). The gross bearing pressure induces structural stresses within the foundation itself while the difference between the gross bearing pressure and overburden pressure (i.e, the “net bearing

pressure”) induces stress in the bearing soils. A completely buried structure like a valve vault (even with additional mass to resist uplift and when full of water with all equipment installed) typically does not weigh more than the soil that was removed for its installation. As a result, the net bearing pressure tends to be low. Since settlement is caused by an increase in net bearing pressure, little to no settlement is expected beneath the valve vault.

The bottom of the proposed valve vault will function as a structural mat foundation. The gross bearing pressure calculated by the designer should be used for structural design purposes because it is derived from the actual dimensions and characteristics of the structure. For preliminary structural design of the mat foundation, we suggest using a gross bearing pressure of 500 psf for a typical five-foot-deep structure until the actual gross bearing pressure is calculated.

The valve vault should be designed to ensure that there is no uplift when it is empty. Uplift resistance should be derived from the weight of the structure along with the weight of the backfill resting on any parts of the foundation that project horizontally beyond the side walls. Side friction resistance along the vertical face of the valve vault walls should not be considered. A groundwater level equal to the finished ground surface should be used to determine uplift resistance.

As discussed earlier in this report, the new valve vault is expected to bear at a depth of about five feet. For design of the valve vault walls, the groundwater should be assumed to be level with the finished ground surface. Under those conditions, we recommend using a saturated soil unit weight of 120 pounds per cubic foot (pcf) and a lateral earth pressure coefficient of 0.5. That coefficient represents the “at-rest” condition because small, enclosed structures tend to be self-bracing and unlikely to deform to the extent needed for the soil to attain the active condition. The same lateral earth pressure coefficient should be applied to surface loads around the valve vault, including nearby shallow foundations and incidental vehicular traffic. In the absence of specific load information, vehicular traffic should be represented by a uniformly distributed vertical load of 250 pounds per square foot (psf). If the groundwater level is assumed to be at the ground surface, the lateral earth pressure induced by the soil only may be represented by an equivalent fluid pressure of 29 pcf for structural design purposes only, to which the hydrostatic pressure must be added.

EARTHWORK FOR BELOW-GRADE CONSTRUCTION

Valve Vault and Pipe Installation

In order to remove the existing concrete vault structure at each site a temporary excavation support system will be needed to withstand the anticipated lateral loads and limit unacceptable movement of the surrounding soils and adjacent structures. Excavation support will also be needed when the new vault and piping are installed. This approach will likely require dewatering of the excavation in order to establish and maintain a dry, stable and safe work area. All below-grade activity should be conducted in accordance with the recommendations for excavation safety and groundwater control presented later in this report.

Careful attention must be paid to the selection, installation, operation, monitoring, maintenance and removal of the temporary excavation support system. It should provide sufficient working room for

typical below-grade activities such as installation of formwork and backfill compaction. As it is being removed, the temporary excavation support system should not disturb the completed structure nor the backfill and adjacent structures. The contractor should prepare contingency plans so that the cause(s) of any observed distress to the excavation support system, surrounding soils, or adjacent structures can be identified promptly and accurately, and addressed decisively.

Conventional construction equipment should be able to dig the excavations. However, since the proposed work areas extended beyond the test boring locations into other areas that were not explored, roots, organic materials, debris, medium dense to dense soils and cemented soils are possible and should be expected, even though such materials were not encountered in the borings. The excavations should be dug to the depths and widths needed for proper removal of the existing structures and installation of the valve vault, the excavation support system, and any below-grade equipment or materials that may be needed. This work should be supervised by a suitably qualified member of the contractor's staff, who should ensure that the excavation is not being over-dug unnecessarily and that the bearing soils are not being disturbed. The supervisor should check for zones of especially loose or soft soils that were not encountered in the test borings. All soft, loose or muddy materials should be carefully and completely removed to expose uniform, undisturbed soil.

Concrete foundations need uniform support to function effectively, even when lightly loaded. As a result, cleared bearing surfaces should be examined and probed by a geotechnical engineer or a suitably qualified representative to locate unusually soft or yielding areas, hard spots or other non-uniform conditions. Non-uniform conditions should be treated as directed by the Engineer and the County in consultation with the examining geotechnical engineer.

Exposed subgrade soils at the bottom of excavations made to install the valve vault and pipes should be thoroughly and uniformly compacted to achieve not less than 95 percent of the maximum dry density obtained by the Modified Proctor method (ASTM D 1557) to a depth at least one foot below subgrade level. Because of the sandy nature of the soils, this work should be done just before foundation concrete is placed to reduce the risk of disturbance. Immediately after the overburden soils have been excavated, a thin layer of non-structural concrete (a "mud mat") may be placed on the exposed subgrade soils at the bottom of the valve vault excavation to protect the bearing soils from disturbance and to provide a stable, durable working surface for the remainder of the construction activity. In lieu of this compaction requirement, exposed subgrade soils at the bottom of the excavation made for the removal of the existing concrete vault at the PS 3365 site should be tamped to a firm and unyielding condition prior to placing backfill.

Backfill should be placed uniformly on all sides of the proposed valve vault and pipes in loose lifts approximately 8 inches thick before initiating compaction. Each lift should be compacted to not less than 95 percent of the maximum dry density obtained by the Modified Proctor method (ASTM D 1557). Similarly, backfill should be placed uniformly within the excavation at the PS 3365 site in loose lifts approximately 8 inches thick before initiating compaction. Each lift should be compacted to not less than 92 percent of the maximum dry density obtained by the Modified Proctor method (ASTM D 1557). Backfill should be tested at a frequency not less than one test per vertical foot of backfill. The contractor should be prepared to change equipment, procedures and lift thickness as

needed (at no additional cost to the Owner) in order to achieve the recommended compaction. Additional recommendations for material reuse are discussed in the following section.

Backfill soils should consist of sand or other inert mineral material with a fines content not more than 12 percent. Backfill soils should be free from mud, muck and other organic materials, debris, rubbish or other materials that might decompose or otherwise cause excessive settlement. Most of the soil to be excavated for the valve vault should satisfy that condition, although some may be too wet or too dry for immediate reuse. General recommendations for material reuse are discussed in the following section.

REUSE OF EXCAVATED MATERIALS

Whenever possible, contractors reuse excavated soils as backfill. As discussed earlier in this report, the encountered soils varied in composition, which is natural and should be expected. As a result, the soil types that may be encountered during excavation on this project may vary. Possible soils are discussed below for general guidance. These guidelines should not be used to override the project specifications.

Poorly Graded Sands (SP)

These soils had fines contents of 5 percent or less, and are commonly referred to as “clean” sands. They are highly desirable for use as fill and backfill in central Florida because they drain freely, which allows these soils to be placed and compacted readily, even if they have been excavated from below the groundwater level. Satisfactory levels of compaction can be achieved using a wide variety of compaction equipment and across a relatively broad range of moisture contents. Because of the relatively small size, sub-rounded shape and near-uniform distribution of the soil particles, some instability or “pumping” can be expected if efforts are made to compact these soils near saturation.

Sands with Silt (SP-SM)

These soils consisted of sands with fines contents between 5 percent and 12 percent. Although these soils do not drain as freely as SP materials, they are still quite suitable for use as fill and backfill. If excavated from below the groundwater surface, they may have to be stockpiled and allowed to drain (or spread to dry) before being placed as fill. Satisfactory compaction can be achieved using a variety of compaction equipment and across a moderate to wide range of moisture contents, but efforts should be made to maintain the moisture content during compaction below the optimum moisture content. As with the SP materials, some instability or “pumping” can be expected if efforts are made to compact these soils as they approach saturation.

Silty Sands (SM)

These soils consisted of sands with fines contents between 12 percent and 50 percent. They do not drain as well as SP-SM soils, and only with very close attention to moisture content and selection of compaction equipment can these soils be used successfully as fill or backfill. Excavated SM soils will likely have to be stockpiled to drain and/or possibly spread to dry before being used. Suitable compaction is generally achieved in these soils only across a narrow range of moisture contents, and

this range narrows even further as the fines content increases. SM soils should be compacted below optimum moisture content to reduce the potential for moisture-related instability. Because of the additional complications associated with reusing these soils, we recommend disposing of soils with fines content higher than 20 percent and replacing them with SP, SP-SM or SP-SC materials.

GROUNDWATER CONTROL

During the rainy season in Florida (normally between June and September), groundwater levels are generally higher than those observed at other times of the year. The extent of the variation depends on several factors, including the terrain, the intensity and duration of rainfall, the hydrogeologic properties of the soils and the presence and proximity of artificial drainage facilities.

Based on our observations in the borings, the time of year of the investigation and a review of the Soil Survey of Orange County, it is our opinion that the seasonal high groundwater level should generally be at a depth below six feet at the location of B-1 (PS 3309), and at a depth within about two feet of the natural ground surface at the location of B-2 (PS 3365). The actual depth to groundwater at each site will be influenced by the depth to water in the adjacent stormwater ponds. Higher levels should be expected during unusually heavy or prolonged rainfall. For purposes of the design of below-grade structures, temporary excavation support systems, and dewatering systems, a groundwater level at the finished ground surface should be used. The encountered and estimated seasonal high groundwater levels are shown on the boring logs in Appendix A.

Groundwater should be expected to influence the proposed construction activity. All excavation and construction should be conducted in the dry. The contractor should be prepared to maintain the groundwater level at least two feet below the bottom of all work areas for the duration of below-grade construction activity. The contractor should be responsible for all aspects of dewatering, regardless of the groundwater level at the time of construction. That responsibility includes not just the installation and operation of an effective dewatering system, but also all permits needed to satisfy applicable environmental regulations, and all groundwater volume and quality monitoring systems. The contractor should also monitor the adjacent ground surface and equipment, and nearby buildings and other facilities for possible subsidence, cracking or other distress that may result from temporarily lowered groundwater levels.

To prevent any instability of the excavations, the groundwater should be drawn down before starting work. Water should be discharged as far as practically possible away from the work area to prevent return flow or erosion. The contractor should have submersible pumps ready to intercept and remove any localized inflows. Dewatering systems should not be decommissioned until below-grade structures are completely backfilled. The importance of proper groundwater control cannot be over-emphasized.

EXCAVATION SAFETY

The sides of all excavations more than four feet deep must be sloped or supported to withstand lateral forces exerted by the existing soils in accordance with the latest regulations promulgated by the Occupational Safety and Health Administration (OSHA). Any excavation support system must also be able to support possible hydrostatic pressures and surcharge loads. For calculating the lateral loads from the site soils on unbraced temporary excavation support systems, we recommend a soil unit weight of 125 pounds per cubic foot (pcf) and a lateral earth pressure coefficient of 0.4. This coefficient should be increased to 0.5 if the system is braced (the “at -rest” condition). The same coefficients should be applied to loads on the ground surface and from traffic (including construction equipment) around the excavations. Traffic loads should be represented by a uniformly distributed surcharge of 250 pounds per square foot (psf).

All excavations must be kept dry so that work can proceed safely and efficiently. As discussed in the GROUNDWATER CONTROL section, the groundwater level should be maintained at least two feet below the bottoms of all excavations. However, dewatering systems can fail, which would allow the groundwater to return to its pre-construction level and possibly fill the excavation. Pumping water out the excavations to resume work can temporarily reduce soil strength. This condition should be analyzed using the design high water level.

LIMITATIONS

This report presents an evaluation of the subsurface conditions on the basis of accepted geotechnical procedures for site characterization. The recovered soil samples were not examined or tested in any way for chemical composition or environmental hazards. The investigation was confined to the zone of soil which is likely to be affected by the proposed construction, and did not address the potential of surface expression of deep geologic activity such as sinkholes. This type of evaluation requires a more extensive range of services than those performed for this study.

Because of the natural limitations inherent in working with the subsurface, a geotechnical engineer cannot predict and address all possible problems. During construction, geotechnical issues not addressed in this report may arise. The bulletin “Important Information About Your Geotechnical Engineering Report” published by the Association of Engineering Firms Practicing in the Geosciences (ASFE) is presented in Appendix B to help explain the nature of geotechnical issues. Additional information is presented in Appendix C to discuss the potential concerns and the basic limitations of a typical geotechnical investigation report.

FIGURES

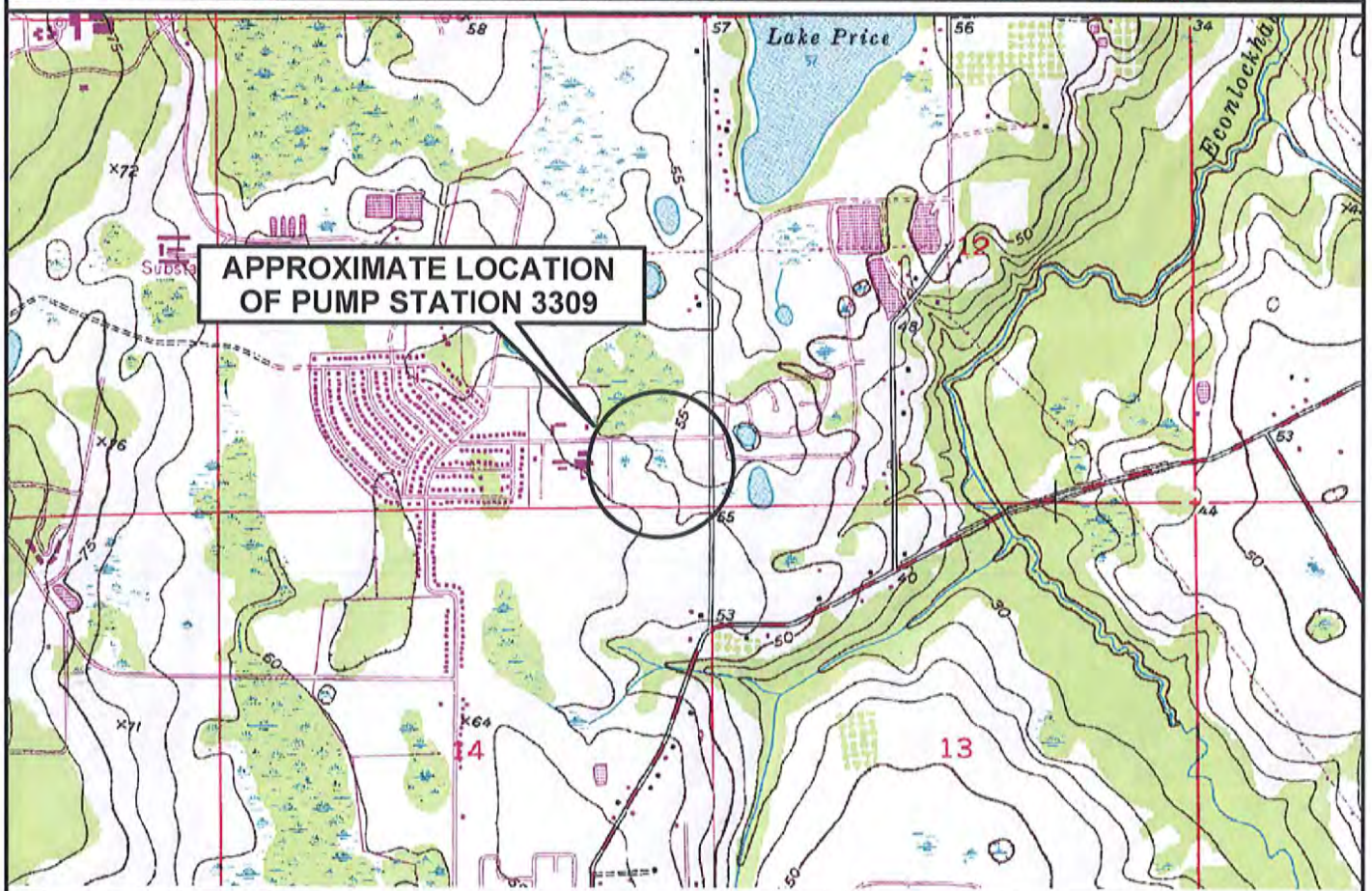
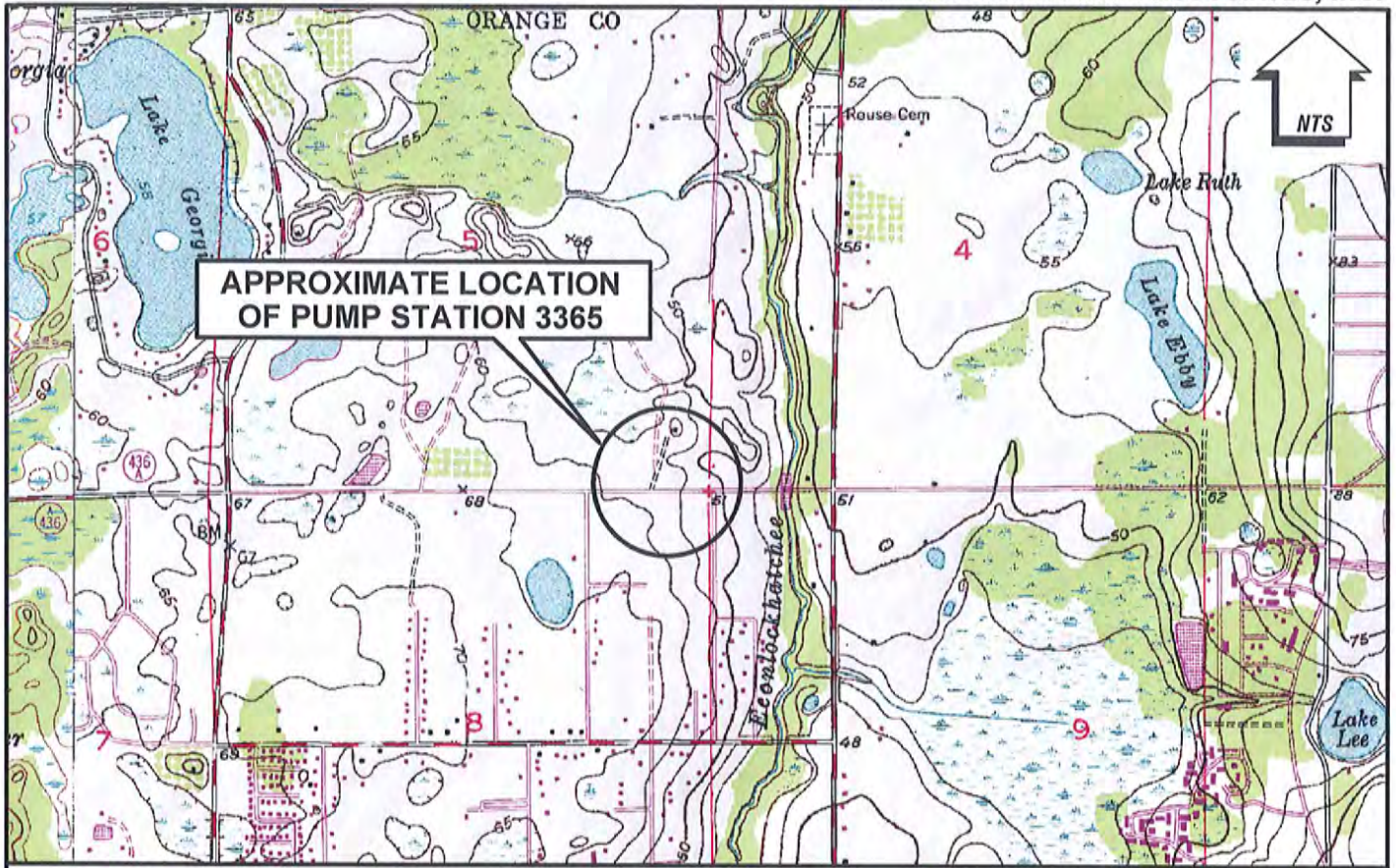

SITE LOCATION MAPS

201112-4

PACKAGE 1 PUMP STATION REHABILITATION

FIG. 1

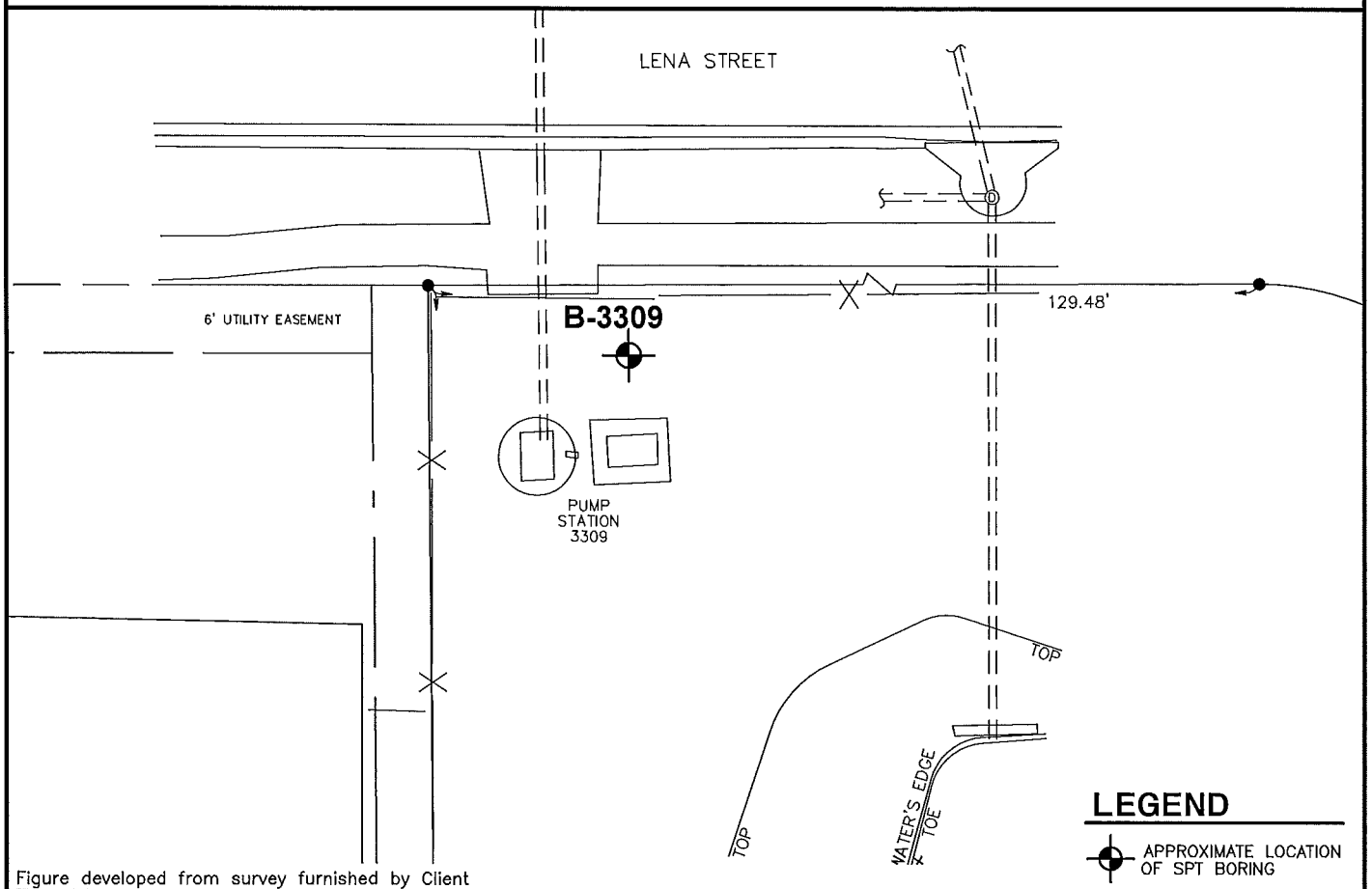
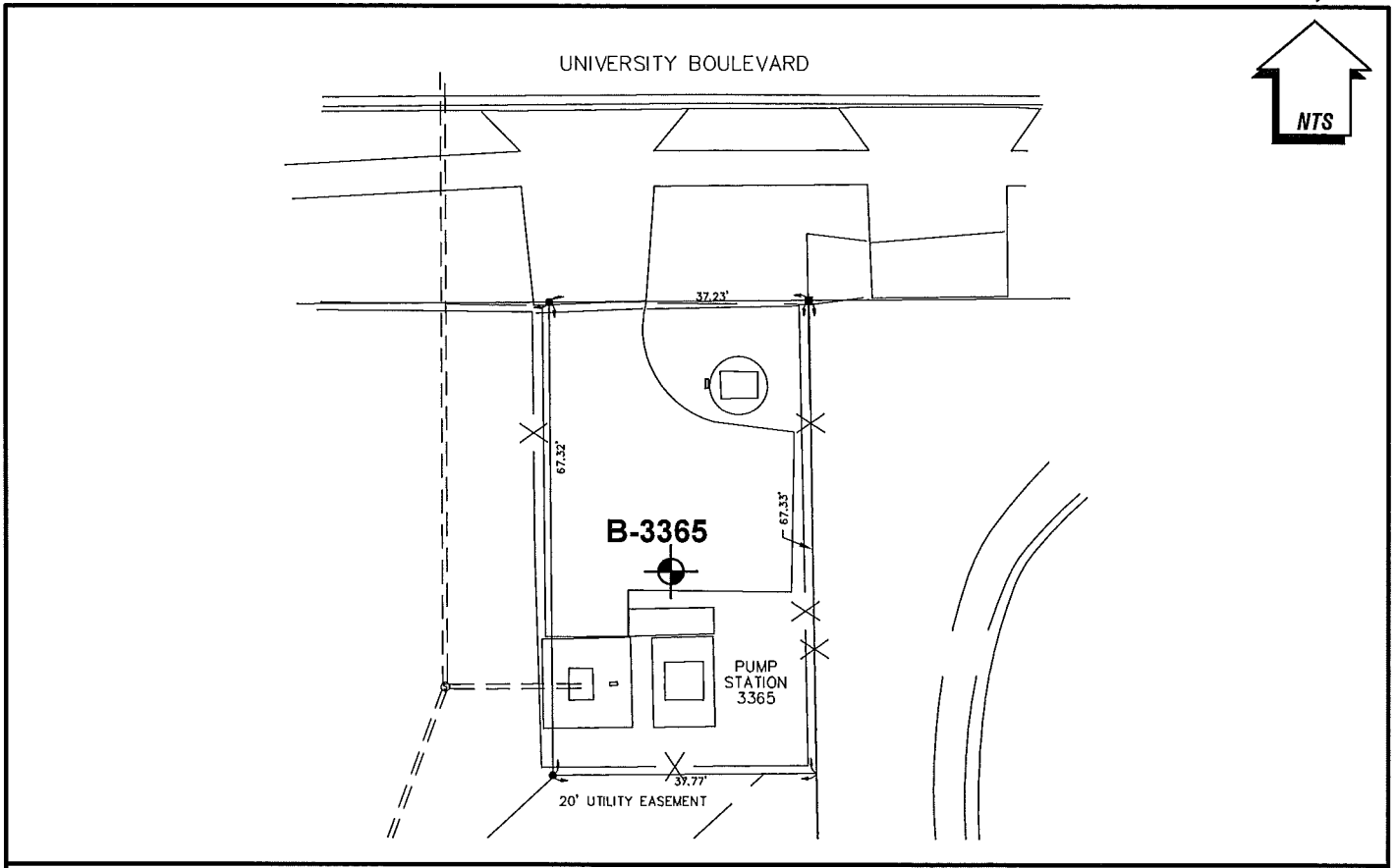

LEGEND

APPROXIMATE LOCATION OF SPT BORING

Figure developed from survey furnished by Client

EXPLORATION LOCATION PLANS

201112-4	PACKAGE 1 PUMP STATION REHABILITATION	FIG. 2
----------	---------------------------------------	--------

S:\Current Projects\BFA OCU Continuing Wastewater Y11-902-A\201112-4 Package 1 Pump Station Rehab\AEA Drawings\Package 1 Master.dwg, Location Plan - Double Viewport, 11/19/2012 3:39:39 PM

APPENDIX A



KEY TO BORING LOGS

SYMBOLS	
10	SPT N-Value (number of blows a 140-lb weight falling 30 inches required to drive a Standard Split-Spoon sampler one foot into otherwise undisturbed soil)
WR	Penetration of sampler under weight of drill rods
WH	Penetration of sampler under weight of drill rods and hammer
SS	Split Spoon sample
ST	Undisturbed thin-walled Shelby Tube sample
—	Observed change in soil type
- - -	Unobserved change in soil type
▽	Estimated seasonal high groundwater level
▼	Encountered groundwater level

SOIL CONSISTENCY	
(Based on empirical correlation with SPT N-Value)	
GRANULAR SOILS	
Very Loose - Less Than 4 blows/ft.	
Loose - 4 to 10 blows/ft.	
Medium Dense - 10 to 30 blows/ft.	
Dense - 30 to 50 blows/ft.	
Very Dense - More Than 50 blows/ft.	
FINE-GRAINED SOILS	
Very Soft - Less Than 2 blows/ft.	
Soft - 2 to 4 blows/ft.	
Firm - 4 to 8 blows/ft.	
Stiff - 8 to 15 blows/ft.	
Very Stiff - 15 to 30 blows/ft.	
Hard - More Than 30 blows/ft.	

UNIFIED SOILS CLASSIFICATION SYSTEM			
ASTM D 2487			
(Based on material passing the 3-inch (75-mm) sieve)			
MAJOR DIVISIONS		GROUP SYMBOLS	TYPICAL NAMES
COARSE-GRAINED SOILS	GRAVELS 50% or more of coarse fraction retained on No. 4 sieve	CLEAN GRAVELS	GW Well-graded gravels and gravel-sand mixtures, little or no fines
		GRAVELS WITH FINES	GP Poorly graded gravels and gravel-sand mixtures, little or no fines
		GC Silty gravels, gravel-sand-silt mixtures	
	SANDS More than 50% of coarse fraction passes No. 4 sieve	CLEAN SANDS	SW Well-graded sands and gravelly sands, little or no fines
		SANDS WITH FINES	SP Poorly graded sands and gravelly sands, little or no fines
		SM Silty sands, sand-silt mixtures	
FINE-GRAINED SOILS	SILTS AND CLAYS Liquid limit 50% or less	ML Inorganic silts, very fine sands, rock flour, silty or clayey fine sands	
		CL Inorganic clays of low to medium plasticity, gravelly clays, sandy clays, silty clays, lean clays	
		OL Organic silts and organic silty clays of low plasticity	
	SILTS AND CLAYS Liquid limit greater than 50%	MH Inorganic silts, micaceous or diatomaceous fine sands or silts, elastic silts	
		CH Inorganic clays of high plasticity, fat clays	
		OH Organic clays of medium to high plasticity	
HIGHLY ORGANIC SOILS	Pt	Peat, muck and other highly organic soils	

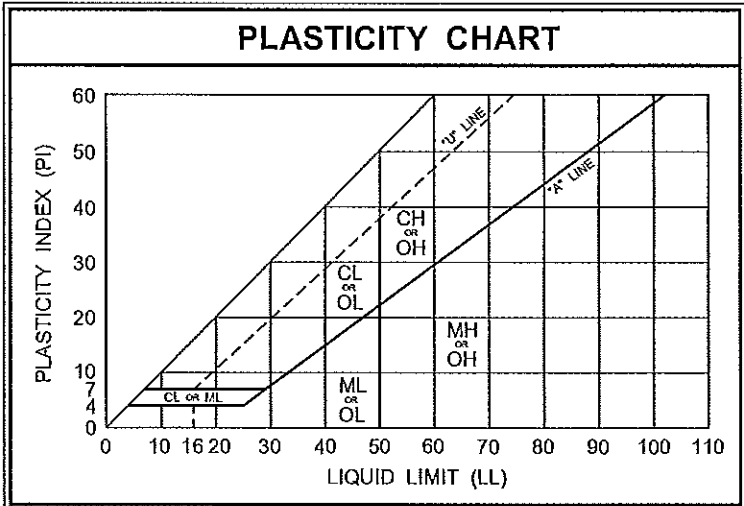



LOG OF BORING B-3309

SHEET 1 OF 1

PROJECT NO: 201112-4	SURFACE ELEVATION: Unknown
PROJECT: Package 1 Pump Station Rehabilitation	GROUNDWATER DEPTH: 12.0
DATE: 10/12/12	COMPLETION DEPTH: 30.0
LOCATION: See Figure 2	DRILLING METHOD: Mud Rotary

DEPTH, ft.	SAMPLES	SPT N-VALUE (bpf)	SAMPLE TYPE	DESCRIPTION	STRATUM EL / DEPTH	SYMBOL	- 200	MC %	LL	PI	OC %
0				Brown fine sand with silt (SP-SM) mixed with gravel							
9			SS	- loose							
13			SS	- medium dense, dark brown, mixed with clayey sands, trace gravel							
7			SS	- loose							
5				(POSSIBLE FILL)							
8			SS	Loose, dark brownish gray, silty fine SAND (SM)	6.0		12				
7			SS								
3			SS	- very loose							
10	WOH		SS	- less silty							
4			SS	Loose, gray, clayey fine SAND (SC)	12.0		22				
11			SS	Medium dense, very light gray fine SAND (SP)	13.5						
15											
17.0					17.0						
13			SS	Medium dense, gray clayey fine SAND (SC)			15				
20											
10			SS	- more clayey			38	34.3	27	9	
25				Loose, light grayish brown, fine SAND with silt (SP-SM)	24.5						
18			SS	- medium dense, gray							
30					30.0						



LOG OF BORING B-3365

SHEET 1 OF 1

PROJECT NO: 201112-4	SURFACE ELEVATION: Unknown
PROJECT: Package 1 Pump Station Rehabilitation	GROUNDWATER DEPTH: 4.0
DATE: 10/12/12	COMPLETION DEPTH: 30.0
LOCATION: See Figure 2	DRILLING METHOD: Mud Rotary

DEPTH, ft.	SAMPLES	SPT N-VALUE (bpf)	SAMPLE TYPE	DESCRIPTION	STRATUM EL / DEPTH	SYMBOL	- 200	MC %	LL	PI	OC %
0				3 inch asphalt and 15 inch limerock (PAVEMENT)							
17			SS	Medium dense, brown fine SAND with silt (SP-SM)	1.5						
20			SS								
5			11	SS - dark grayish brown			6				
			11	SS - dark brown, less silt							
			16	SS			4				
			15	SS							
10											
			4	SS Very loose, dark brown, silty fine SAND with organic fines (SM)	12.0		25	38.7			19.5
15											
			32	SS Dense, dark grayish brown fine SAND with silt (SP-SM) with trace wood and roots	17.0						
20											
			21	SS - medium dense, less silt, more wood and roots							
25											
			20	SS - dark brown, more silt, no wood or roots							
30					30.0						

Project: **Package 1 Pump Station Rehabilitation**

Job Number: **201112-4**

Sheet **1** of **1**

Manager: _____ Client: _____ Project Description: _____
 Location: **See Figure 2** _____

Boring Depth	Sample Description					Fines #200	Water Content	LL	PI	Organic Content	k (ft/day)	AASHTO	USCS
	#4	#10	#40	#60	#100								
B-3309 6.0	Dark brownish gray silty fine sand					11.8							
B-3309 12.5	Gray clayey fine sand					21.5							
B-3309 18.5	Gray clayey fine sand					14.6							
B-3309 23.5	Gray clayey fine sand					38.4	34.3	27.3	8.8				
B-3365 4.0	Brown fine sand with silt					6.4							
B-3365 7.0	Brown fine sand					4.1							
B-3365 13.5	Dark brown silty fine sand with organic fines					25.0	38.7			19.5			

**Summary Of
Laboratory Test Results**



APPENDIX B

IMPORTANT INFORMATION ABOUT YOUR GEOTECHNICAL ENGINEERING REPORT

More construction problems are caused by site subsurface conditions than any other factor. As troublesome as subsurface problems can be, their frequency and extent have been lessened considerably in recent years, due in large measure to programs and publications of ASFE/ The Association of Engineering Firms Practicing in the Geosciences.

The following suggestions and observations are offered to help you reduce the geotechnical-related delays, cost-overruns and other costly headaches that can occur during a construction project.

A GEOTECHNICAL ENGINEERING REPORT IS BASED ON A UNIQUE SET OF PROJECT-SPECIFIC FACTORS

A geotechnical engineering report is based on a subsurface exploration plan designed to incorporate a unique set of project-specific factors. These typically include: the general nature of the structure involved, its size and configuration; the location of the structure on the site and its orientation; physical concomitants such as access roads, parking lots, and underground utilities, and the level of additional risk which the client assumed by virtue of limitations imposed upon the exploratory program. To help avoid costly problems, consult the geotechnical engineer to determine how any factors which change subsequent to the date of the report may affect its recommendations.

Unless your consulting geotechnical engineer indicates otherwise, *your geotechnical engineering report should not be used:*

- When the nature of the proposed structure is changed, for example, if an office building will be erected instead of a parking garage, or if a refrigerated warehouse will be built instead of an unrefrigerated one;
- when the size or configuration of the proposed structure is altered;
- when the location or orientation of the proposed structure is modified;
- when there is a change of ownership, or
- for application to an adjacent site.

Geotechnical engineers cannot accept responsibility for problems which may develop if they are not consulted after factors considered in their report's development have changed.

MOST GEOTECHNICAL "FINDINGS" ARE PROFESSIONAL ESTIMATES

Site exploration identifies actual subsurface conditions only at those points where samples are taken, when they are taken. Data derived through sampling and subsequent laboratory testing are extrapolated by geo-

technical engineers who then render an opinion about overall subsurface conditions, their likely reaction to proposed construction activity, and appropriate foundation design. Even under optimal circumstances actual conditions may differ from those inferred to exist, because no geotechnical engineer, no matter how qualified, and no subsurface exploration program, no matter how comprehensive, can reveal what is hidden by earth, rock and time. The actual interface between materials may be far more gradual or abrupt than a report indicates. Actual conditions in areas not sampled may differ from predictions. *Nothing can be done to prevent the unanticipated, but steps can be taken to help minimize their impact.* For this reason, *most experienced owners retain their geotechnical consultants through the construction stage*, to identify variances, conduct additional tests which may be needed, and to recommend solutions to problems encountered on site.

SUBSURFACE CONDITIONS CAN CHANGE

Subsurface conditions may be modified by constantly-changing natural forces. Because a geotechnical engineering report is based on conditions which existed at the time of subsurface exploration, *construction decisions should not be based on a geotechnical engineering report whose adequacy may have been affected by time.* Speak with the geotechnical consultant to learn if additional tests are advisable before construction starts.

Construction operations at or adjacent to the site and natural events such as floods, earthquakes or groundwater fluctuations may also affect subsurface conditions and, thus, the continuing adequacy of a geotechnical report. The geotechnical engineer should be kept apprised of any such events, and should be consulted to determine if additional tests are necessary.

GEOTECHNICAL SERVICES ARE PERFORMED FOR SPECIFIC PURPOSES AND PERSONS

Geotechnical engineers' reports are prepared to meet the specific needs of specific individuals. A report prepared for a consulting civil engineer may not be adequate for a construction contractor, or even some other consulting civil engineer. Unless indicated otherwise, this report was prepared expressly for the client involved and expressly for purposes indicated by the client. Use by any other persons for any purpose, or by the client for a different purpose, may result in problems. *No individual other than the client should apply this report for its intended purpose without first conferring with the geotechnical engineer. No person should apply this report for any purpose other than that originally contemplated without first conferring with the geotechnical engineer.*

A GEOTECHNICAL ENGINEERING REPORT IS SUBJECT TO MISINTERPRETATION

Costly problems can occur when other design professionals develop their plans based on misinterpretations of a geotechnical engineering report. To help avoid these problems, the geotechnical engineer should be retained to work with other appropriate design professionals to explain relevant geotechnical findings and to review the adequacy of their plans and specifications relative to geotechnical issues.

BORING LOGS SHOULD NOT BE SEPARATED FROM THE ENGINEERING REPORT

Final boring logs are developed by geotechnical engineers based upon their interpretation of field logs (assembled by site personnel) and laboratory evaluation of field samples. Only final boring logs customarily are included in geotechnical engineering reports. *These logs should not under any circumstances be redrawn* for inclusion in architectural or other design drawings, because drafters may commit errors or omissions in the transfer process. Although photographic reproduction eliminates this problem, it does nothing to minimize the possibility of contractors misinterpreting the logs during bid preparation. When this occurs, delays, disputes and unanticipated costs are the all-too-frequent result.

To minimize the likelihood of boring log misinterpretation, *give contractors ready access to the complete geotechnical engineering report prepared or authorized for their use.* Those who do not provide such access may proceed un-

der the *mistaken* impression that simply disclaiming responsibility for the accuracy of subsurface information always insulates them from attendant liability. Providing the best available information to contractors helps prevent costly construction problems and the adversarial attitudes which aggravate them to disproportionate scale.

READ RESPONSIBILITY CLAUSES CLOSELY

Because geotechnical engineering is based extensively on judgment and opinion, it is far less exact than other design disciplines. This situation has resulted in wholly unwarranted claims being lodged against geotechnical consultants. To help prevent this problem, geotechnical engineers have developed model clauses for use in written transmittals. These are *not* exculpatory clauses designed to foist geotechnical engineers' liabilities onto someone else. Rather, they are definitive clauses which identify where geotechnical engineers' responsibilities begin and end. Their use helps all parties involved recognize their individual responsibilities and take appropriate action. Some of these definitive clauses are likely to appear in your geotechnical engineering report, and you are encouraged to read them closely. Your geotechnical engineer will be pleased to give full and frank answers to your questions.

OTHER STEPS YOU CAN TAKE TO REDUCE RISK

Your consulting geotechnical engineer will be pleased to discuss other techniques which can be employed to mitigate risk. In addition, ASFE has developed a variety of materials which may be beneficial. Contact ASFE for a complimentary copy of its publications directory.

Published by

ASFE THE ASSOCIATION
OF ENGINEERING FIRMS
PRACTICING IN THE GEOSCIENCES

8811 Colesville Road/Suite G106/Silver Spring, Maryland 20910/(301) 565-2733

APPENDIX C

ANTILLIAN ENGINEERING ASSOCIATES, INC. CONSTRAINTS AND RESTRICTIONS

WARRANTY

Antillian Engineering Associates, Inc. has prepared this report for our client for his exclusive use, in accordance with generally accepted soil and foundation engineering practices, and makes no other warranty either expressed or implied as to the professional advice provided in the report.

UNANTICIPATED SOIL CONDITIONS

The analysis and recommendations submitted in this report are based upon the data obtained from soil borings performed at the locations indicated on the Boring Location Plan. This report does not reflect any variations which may occur between these borings.

CHANGED CONDITIONS

We recommend that the specifications for the project require that the contractor immediately notify Antillian Engineering Associates, Inc., as well as the owner, when subsurface conditions are encountered that are different from those present in this report.

No claim by the contractor for any conditions differing from those anticipated in the plans, specifications, and those found in this report, should be allowed unless the contractor notifies the owner and Antillian Engineering Associates, Inc. of such changed conditions. Further, we recommend that all foundation work and site improvements be observed by a representative of Antillian Engineering Associates, Inc. to monitor field conditions and changes, to verify design assumptions and to evaluate and recommend any appropriate modifications to this report.

MISINTERPRETATION OF SOIL ENGINEERING REPORT

Antillian Engineering Associates, Inc. is responsible for the conclusions and opinions contained within this report based upon the data relating only to the specific project and location discussed herein. If the conclusions or recommendations based upon the data presented are made by others, those conclusions or recommendations are not the responsibility of Antillian Engineering Associates, Inc..

CHANGED STRUCTURE OR LOCATION

This report was prepared in order to aid in the evaluation of this project and to assist the architect or engineer in the design of this project. If any changes in the design or location of the structure as outlined in this report are planned, or if any structures are included or added that are not discussed in the report, the conclusions and recommendations contained in this report shall not be considered valid unless the changes are reviewed and the conclusions modified or approved by Antillian Engineering Associates, Inc..

USE OF REPORT BY BIDDERS

Bidders who are examining the report prior to submission of a bid are cautioned that this report was prepared as an aid to the designers of the project and it may affect actual construction operations.

Bidders are urged to make their own soil borings, test pits, test caissons or other investigations to determine those conditions that may affect construction operations. Antillian Engineering Associates, Inc. cannot be responsible for any interpretations made from this report or the attached boring logs with regard to their adequacy in reflecting subsurface conditions which will affect construction operations.

STRATA CHANGES

Strata changes are indicated by a definite line on the boring logs which accompany this report. However, the actual change in the ground may be more gradual. Where changes occur between soil samples, the location of the change must necessarily be estimated using all available information and may not be shown at the exact depth.

OBSERVATIONS DURING DRILLING

Attempts are made to detect and/or identify occurrences during drilling and sampling, such as: water level, boulders, zones of lost circulation, relative ease or resistance to drilling progress, unusual sample recovery, variation of driving resistance, obstructions, etc.; however, lack of mention does not preclude their presence.

WATER LEVELS

Water level readings have been made in the drill holes during drilling and they indicate normally occurring conditions. Water levels may not have been stabilized at the last reading. This data has been reviewed and interpretations made in this report. However, it must be noted that fluctuations in the level of the groundwater may occur due to variations in rainfall, temperature, tides, and other factors not evident at the time measurements were made and reported. Since the probability of such variations is anticipated, design drawings and specifications should accommodate such possibilities and construction planning should be based upon such assumptions of variations.

LOCATION OF BURIED OBJECTS

All users of this report are cautioned that there was no requirement for Antillian Engineering Associates, Inc. to attempt to locate any man-made buried objects during the course of this exploration and that no attempt was made by Antillian Engineering Associates, Inc. to locate any such buried objects. Antillian Engineering Associates, Inc. cannot be responsible for any buried man-made objects which are subsequently encountered during construction that are not discussed within the text of this report.

TIME

This report reflects the soil conditions at the time of investigation. If the report is not used in a reasonable amount of time, significant changes to the site may occur and additional reviews may be required.

Barnes, Ferland, and Associates, Inc.

**1230 Hillcrest Street
(407) 896-8608**

**Orlando, Florida 32803
Fax (407) 896-1822**

MEMORANDUM

BFA #2011-11.13

TO: Mr. Tad Parker, P.E., Orange County Utilities
FROM: John Watson, P.H., Barnes Ferland and Associates, Inc.
DATE: June 6, 2013

**SUBJECT: Orange County Contract Y11-902A Subtask 420.
Ground Water Sampling and Laboratory Screening Results at Pump Station Nos. 3365 and
3309.**

This memo is to present the results of Barnes Ferland and Associates, Inc.'s (BFA) groundwater quality sampling and screening analysis performed for Orange County Utility's (OCU) Pump Station R & R Package 1 Pump Station No. 3309 (Lena Street) and No. 3365 (University Blvd. and Rouse Rd.). The overall Project will involve improvements at each pump station generally consisting of wet well rehabilitation and lining which will require dewatering (Figure 1).

Objective:

The Contractor selected for the Project will need to perform construction dewatering in order to complete the proposed wet well improvements "in the dry" as will be required by the contract documents. Therefore, at least 30 days prior to performing construction dewatering for the project, the Contractor is required by FDEP to submit a *Generic Permit for the Discharge of Produced Groundwater from any Non-Contaminated Site Activity - FDEP Document No. 62-621.300(2)* (attached). As part of the Generic Permit, the Contractor shall first sample, test and report to FDEP that the groundwater to be discharged does not contain contaminants above the maximum acceptable parameters listed in Table 1 of the Generic Permit. However, if any of the analytical test results exceed the screening values listed in Table 1, except TOC, the project will not qualify under the Generic Permit and the Contractor will be required to apply for an Individual Wastewater Application at least 90 days prior to the date of discharge to surface waters of the State.

Orange County recognizes the potential delays this permitting process may have on the Project. The actual start date of construction of the proposed transmission mains is dependent on the quality of the groundwater to be discharged during construction dewatering. The objective of BFA's ground water sampling and screening analysis, during this preliminary phase of the project, is to detect the presence of parameters listed in Table 1 of the Generic Permit and provide the results prior to bidding the construction project.

Pump Station Nos. 3365 and 3309
Groundwater Sampling and Analysis Results
Page 2
June 6, 2013

Methodology:

BFA obtained one groundwater sample at each pump station collected from temporary piezometers (Figures 1 & 2). For each sample location, BFA first manually excavated to the ground water table with a post-hole digger, then beyond with a manual stainless steel hand auger. We then inserted a 1-inch diameter ten-slot per inch 1/100" screened piezometer into the excavation and below the water table. A silica sand filter pack was also placed in the annulus above the water table. Utilizing a peristaltic pump, we drew ground water through the piezometer at a relatively high volume for approximately 45 minutes followed by a low volume withdrawal for approximately 15 minutes to reduce turbidity as much as possible prior to collecting the ground water samples. Once the groundwater was visibly clear, then samples were collected, labeled, placed in a cooler w/ice and delivered to a certified testing laboratory for analysis with respect to the parameters listed in Table 1 of the Generic Permit.

Results:

Below is a summary table of laboratory results, followed by laboratory reports prepared by Accutest.

Parameter	Screening Value	Pump Sta. 3365 (B1) University and Rouse	Pump Sta. 3309 (B2) Lena Street
Total Organic Carbon (TOC)	10 mg/L	17.1	5.8
pH, standard units	6.0-8.5	5.86	7.38
Total Recoverable Mercury	0.012 µg/L	0.014	0.0024
Total Recoverable Cadmium	9.3 µg/L	0.5 U	0.5 U
Total Recoverable Copper	2.9 µg/L	1.0 U	1.0 U
Total Recoverable Lead	0.03 mg/L	0.0011 U	0.0011 U
Total Recoverable Zinc	86.0 µg/L	12.3 I	5.4 I
Total Recoverable Chromium (Hex)	11.0 µg/L	8.0 U	8.0 U
Benzene	1.0 µg/L	0.21 U	0.21 U
Napthalene	100.0 µg/L	1.0 U	1.0 U
Hardness, total as CaCO3	mg/L	79.8	112

BFA performed a site search for contaminated sites using the FDEP Contamination Locator Map (CLEM). No sites were identified within a half mile radius of each of these pump stations (Figures 4 & 5). No FDEP screening values were exceeded at Pump Station 3309 at Lena Street. At Pump Station 3365 (University and Rouse), the FDEP screening values were exceeded for total organic carbon, a low pH and mercury. Because the laboratory results indicate that TOC, pH and mercury exceed the FDEP screening criteria, the dewatering discharge may not be covered by the Generic Permit. The TOC and pH compounds likely occur naturally and may be exempt if demonstrated by the permittee. Re-sampling of mercury may result in concentrations below the screening values due to seasonal/recharge variations. However, if any of the re-sampled analytical test results exceed the screening values listed in Table 1, the project will likely not qualify under the Generic Permit and the Contractor would be required to apply for an Individual Wastewater Application at least 90 days prior to the date of discharge to surface waters of the State. No discharge is permissible without an effective permit. Additional treatment of

discharge water for adverse contaminants may be required in accordance with the FDEP permit conditions and the County's project Dewatering Specifications (Section 02140-3.03).

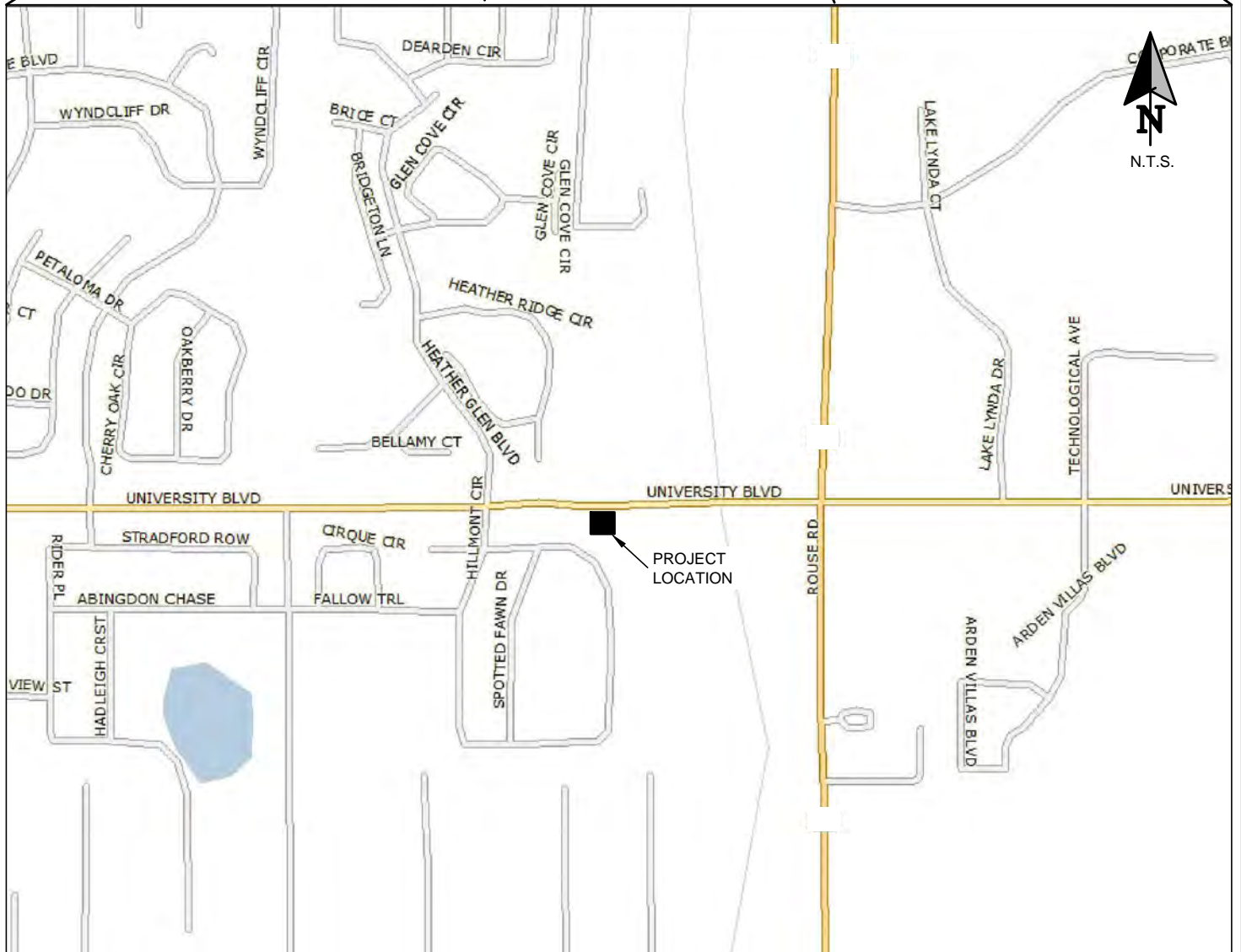
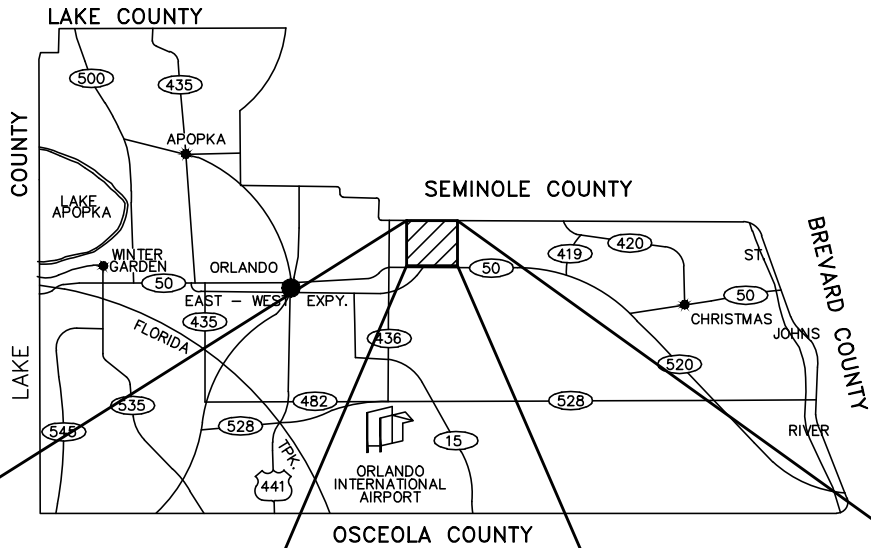

F:\CIVIL\PROJECTS\2011\2011-11 OCU Continuing\11-11-13 Package 1 Pump Stations\5.0 Drawings\2011-11-13 Package 1 Pump Stations Figure 1.dwg
 Monday, January 07, 2013 11:57:30 AM

 ORANGE COUNTY UTILITIES
 ENGINEERING DIVISION
 5190 CURRY FORD ROAD
 ORLANDO, FL 32825

BFA Environmental Consultants
Barnes, Ferland and Associates, Inc.
 1230 E. Hillcrest Street, Orlando, FL 32803
 TEL: (407) 895-9999 FAX: (407) 895-7999
 ENGINEERING BUSINESS No. 6899

R&R Package 1 Pump Station Improvements
 PRELIMINARY DESIGN REPORT
University and Rouse PS #3365
LOCATION MAP

FIGURE
1

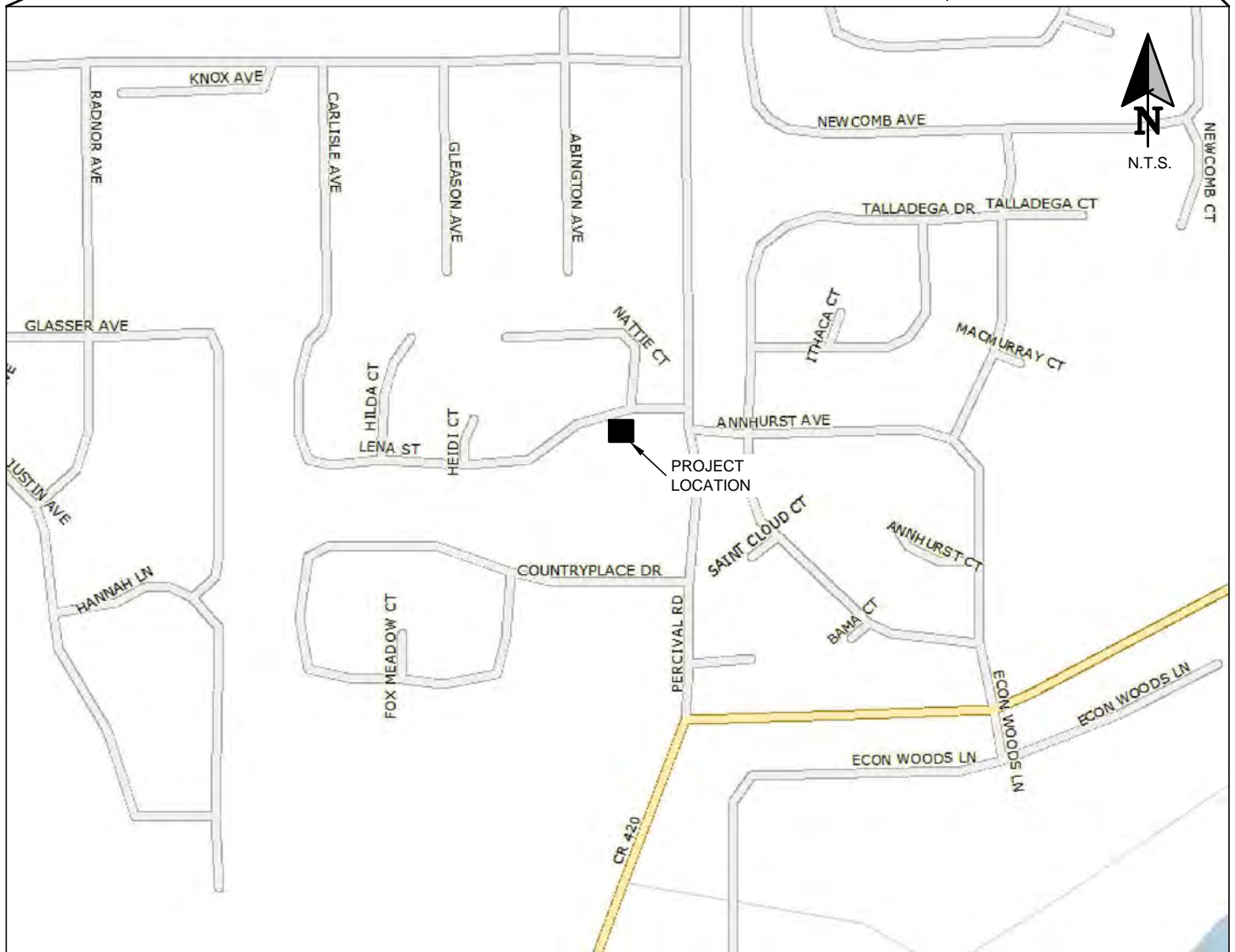
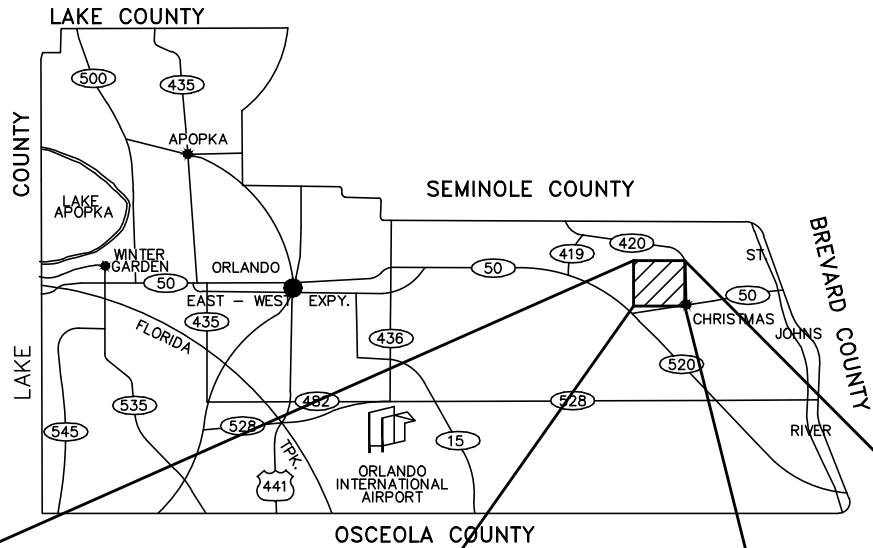

C:\CIVIL\PROJECTS\2011\2011-11 OCU Continuing\11-11-13 Package 1 Pump Stations\5.0 Drawings\2011-11-13 Package 1 Pump Stations\Figure 2.dwg
Monday, January 07, 2013 11:57:30 AM

ORANGE COUNTY
 ORANGE COUNTY UTILITIES
 ENGINEERING DIVISION
 5190 CURRY FORD ROAD
 ORLANDO, FL 32825

BFA Environmental Consultants
Barnes, Ferland and Associates, Inc.
 1230 E. Hillcrest Street, Orlando, FL 32803
 P.O. BOX 6000 TEL: (407) 836-9000 FAX: (407) 836-9000
 ENGINEERING BUSINESS No. 6899

R&R Package 1 Pump Station Improvements
 PRELIMINARY DESIGN REPORT
**Lena Street PS #3309
 LOCATION MAP**

**FIGURE
 2**



University and Rouse PS #3365 (Lab ID B1)



Lena Street PS#3309 (Lab ID B2)

Figure 3 - Groundwater Sampling Locations



Map Direct: Contamination Locator Map (CLM)

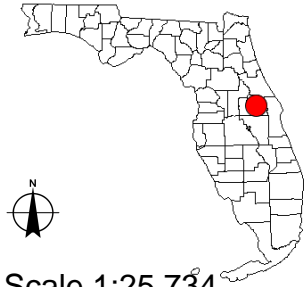

28°36'17.0367", -81°12'6.2148"

28°36'13.4937", -81°9'10.1453"

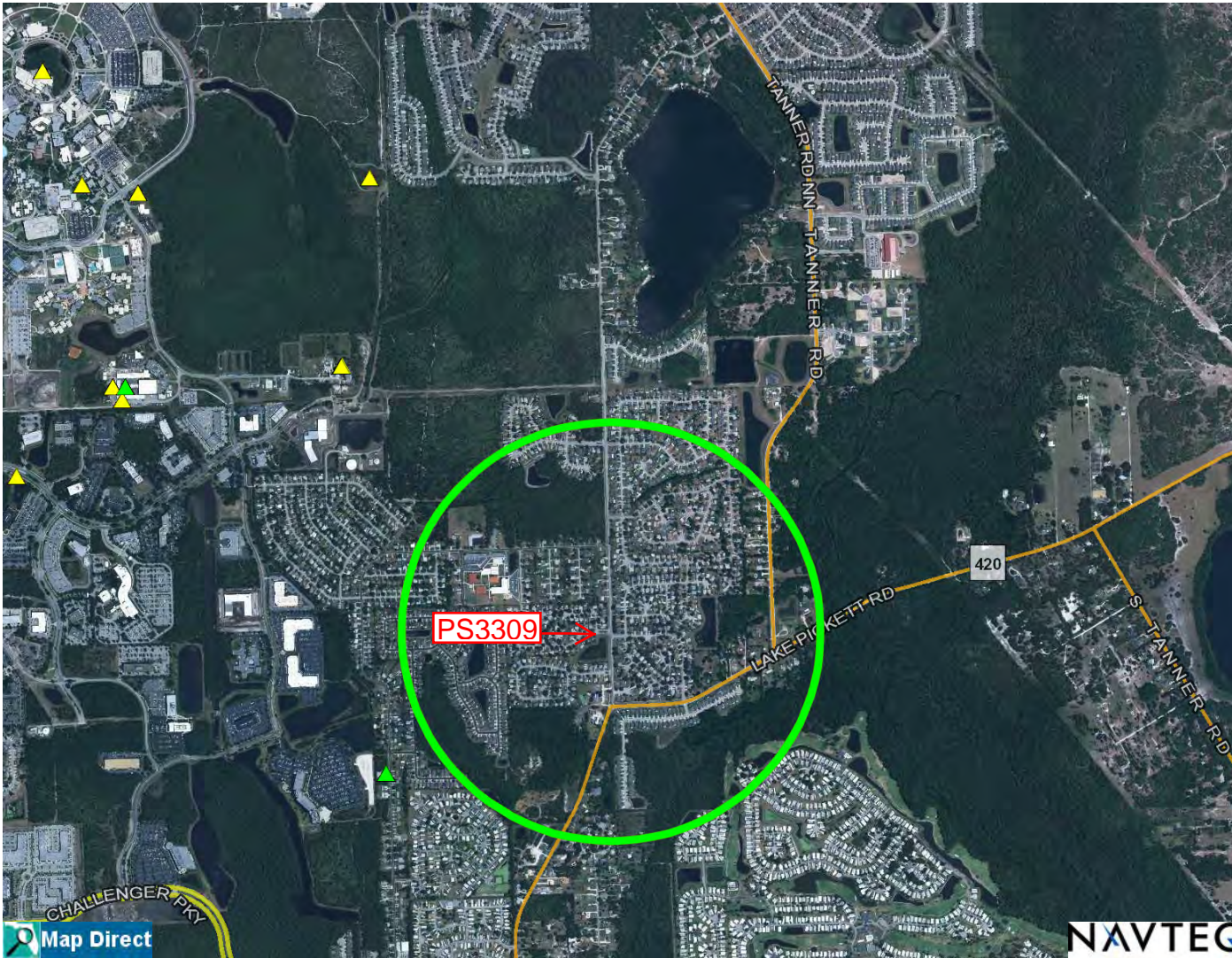

28°34'17.8839", -81°12'9.2907"

28°34'14.3421", -81°9'13.2749"



Scale 1:25,734

- Aerial Imagery 2004-2009
- DEP Cleanup Sites - Contamination Locator Map
 - ▲ PETROLEUM
 - ▲ OTHER WASTE CLEANUP
 - ▲ BROWNFIELD SITES
 - ▲ SUPERFUND
- Counties
- Aerial Imagery Flight Dates 2004-2009

Florida Department of Environmental Protection Disclaimer: This map created in Map Direct on Fri, 7 Jun 2013 15:12:52 UTC is intended for display purposes only. It was created using data from different sources collected at different scales, with different levels of accuracy, and/or covering different periods of time. NAVTEQ road data is provided "AS IS" and without warranties of any kind, either express or implied, including, but not limited to, the implied warranties of merchantability, fitness for a particular purpose, satisfactory quality and non-infringement. YOU SHOULD THEREFORE VERIFY ANY INFORMATION OBTAINED FROM THE SITE BEFORE ACTING ON IT.

PS 3309 Vicinity



Map Direct: Contamination Locator Map (CLM)

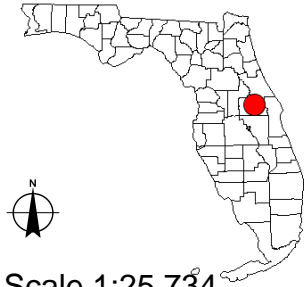

Scale 1:25,734

Aerial Imagery 2004-2009

DEP Cleanup Sites -
Contamination Locator Map
PETROLEUM



OTHER WASTE CLEANUP



BROWNFIELD SITES



SUPERFUND



Counties



Aerial Imagery Flight Dates
2004-2009

28°36'52.4587", -81°14'55.2864"

28°36'48.9747", -81°11'59.1994"

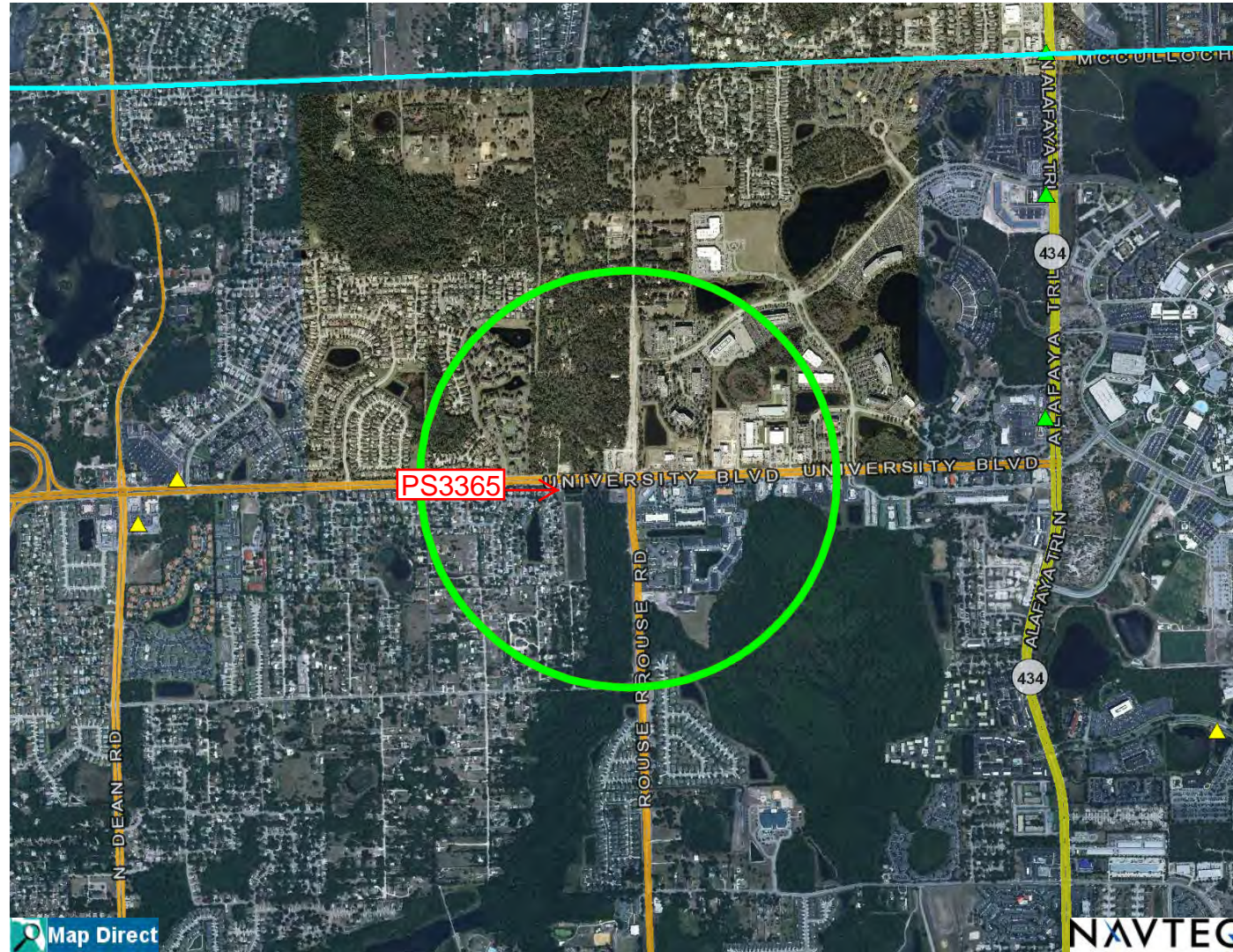

28°34'53.3048", -81°14'58.3110"

28°34'49.8219", -81°12'2.2777"

Florida Department of Environmental Protection Disclaimer: This map created in Map Direct on Fri, 7 Jun 2013 15:16:53 UTC is intended for display purposes only. It was created using data from different sources collected at different scales, with different levels of accuracy, and/or covering different periods of time. NAVTEQ road data is provided "AS IS" and without warranties of any kind, either express or implied, including, but not limited to, the implied warranties of merchantability, fitness for a particular purpose, satisfactory quality and non-infringement. YOU SHOULD THEREFORE VERIFY ANY INFORMATION OBTAINED FROM THE SITE BEFORE ACTING ON IT.

PS 3365

STATE OF FLORIDA

DEPARTMENT OF ENVIRONMENTAL PROTECTION

GENERIC PERMIT

FOR THE

DISCHARGE OF PRODUCED GROUND WATER

FROM ANY NON-CONTAMINATED SITE ACTIVITY

Generic Permit for the Discharge of Produced Ground Water from any Non-Contaminated Site Activity

(1) The facility is authorized to discharge produced ground water from any non-contaminated site activity which discharges by a point source to surface waters of the State, as defined in Chapter 62-620, F.A.C., only if the reported values for the parameters listed in Table 1 do not exceed any of the listed screening values. Before discharge of produced ground water can occur from such sites, analytical tests on samples of the proposed untreated discharge water shall be performed to determine if contamination exists.

(2) Minimum reporting requirements for all produced ground water dischargers. The effluent shall be sampled before the commencement of discharge, again within thirty (30) days after commencement of discharge, and then once every six (6) months for the life of the project to maintain continued coverage under this generic permit. Samples taken in compliance with the provisions of this permit shall be taken prior to actual discharge or mixing with the receiving waters. The effluent shall be sampled for the parameters listed in Table 1.

Table 1

Parameter	Screening Values for Discharges into:	
	Fresh Waters	Coastal Waters
Total Organic Carbon (TOC)	10.0 mg/l	10.0 mg/l
pH, standard units	6.0-8.5	6.5-8.5
Total Recoverable Mercury	0.012 µg/l	0.025 µg/l
Total Recoverable Cadmium	9.3 µg/l	9.3 µg/l
Total Recoverable Copper	2.9 µg/l	2.9 µg/l
Total Recoverable Lead	0.03 mg/l	5.6 µg/l
Total Recoverable Zinc	86.0 µg/l	86.0 µg/l
Total Recoverable Chromium (Hex.)	11.0 µg/l	50.0 µg/l
Benzene	1.0 µg/l	1.0 µg/l
Naphthalene	100.0 µg/l	100.0 µg/l

(3) If any of the analytical test results exceed the screening values listed in Table 1, except TOC, the discharge is not authorized by this permit.

(a) For initial TOC values that exceed the screening values listed in Table 1, which may be caused by naturally-occurring, high molecular weight organic compounds, the permittee may request to be exempted from the TOC requirement. To request this exemption, the permittee shall submit additional information with a Notice of Intent (NOI),

described below, which describes the method used to determine that these compounds are naturally occurring. The Department shall grant the exemption if the permittee affirmatively demonstrates that the TOC values are caused by naturally-occurring, high molecular weight organic compounds.

(b) The NOI shall be submitted to the appropriate Department district office thirty (30) days prior to discharge, and contain the following information:

1. the name and address of the person that the permit coverage will be issued to;
2. the name and address of the facility, including county location;
3. any applicable individual wastewater permit number(s);
4. a map showing the facility and discharge location (including latitude and longitude);
5. the name of the receiving water; and
6. the additional information required by paragraph (3)(a) of this permit.

(c) Discharge shall not commence until notification of coverage is received from the Department.

(4) For fresh waters and coastal waters, the pH of the effluent shall not be lowered to less than 6.0 units for fresh waters, or less than 6.5 units for coastal waters, or raised above 8.5 units, unless the permittee submits natural background data confirming a natural background pH outside of this range. If natural background of the receiving water is determined to be less than 6.0 units for fresh waters, or less than 6.5 units in coastal waters, the pH shall not vary below natural background or vary more than one (1) unit above natural background for fresh and coastal waters. If natural background of the receiving water is determined to be higher than 8.5 units, the pH shall not vary above natural background or vary more than one (1) unit below natural background of fresh and coastal waters. The permittee shall include the natural background pH of the receiving waters with the results of the analyses required under paragraph (2) of this permit. For purposes of this section only, fresh waters are those having a chloride concentration of less than 1500 mg/l, and coastal waters are those having a chloride concentration equal to or greater than 1500 mg/l.

(5) In accordance with Rule 62-302.500(1)(a-c), F.A.C., the discharge shall at all times be free from floating solids, visible foam, turbidity, or visible oil in such amounts as to form nuisances on surface waters.

(6) If contamination exists, as indicated by the results of the analytical tests required by paragraph (2), the discharge cannot be covered by this generic permit. The facility shall apply for an individual wastewater permit at least ninety (90) days prior to the date discharge to surface waters of the State is expected, or, if applicable, the facility may seek coverage under any other applicable Department generic permit. No discharge is permissible without an effective permit.

(7) If the analytical tests required by paragraph (2) reveal that no contamination exists from any source, the facility can begin discharge immediately and is covered by this permit without having to submit an NOI request for coverage to the Department. A short summary of the proposed activity and copy of the analytical tests shall be sent to the applicable Department district office within one (1) week after discharge begins. These analytical tests shall be kept on site during discharge and made available to the Department if requested. Additionally, no Discharge Monitoring Report forms are required to be submitted to the Department.

(8) All of the general conditions listed in Rule 62-621.250, F.A.C., are applicable to this generic permit.

(9) There are no annual fees associated with the use of this generic permit.

Technical Report for

BFA Environmental Consultants

Orange County Dewatering Screening; FL

3309/3365

Accutest Job Number: FA3595

Sampling Date: 04/11/13

Report to:

BFA Environmental Consultants
1230 Hillcrest St Suite 100
Orlando, FL 32803
jwatson@bfaenvironmental.com

ATTN: John Watson

Total number of pages in report: **38**



Test results contained within this data package meet the requirements of the National Environmental Laboratory Accreditation Conference and/or state specific certification programs as applicable.



Harry Behzadi, Ph.D.
Laboratory Director

Client Service contact: Jean Dent-Smith 407-425-6700

Certifications: FL (E83510), LA (03051), KS (E-10327), IA (366), IL (200063), NC (573), NJ (FL002), SC (96038001)
DoD ELAP (L-A-B L2229), CA (04226CA), TX (T104704404), AK, AR, GA, KY, MA, NV, OK, UT, VA, WA, WI

This report shall not be reproduced, except in its entirety, without the written approval of Accutest Laboratories.
Test results relate only to samples analyzed.

Table of Contents

-1-

Section 1: Sample Summary	3
Section 2: Summary of Hits	4
Section 3: Sample Results	5
3.1: FA3595-1: B-2	6
3.2: FA3595-2: B-1	9
Section 4: Misc. Forms	12
4.1: Chain of Custody	13
Section 5: GC/MS Volatiles - QC Data Summaries	15
5.1: Method Blank Summary	16
5.2: Blank Spike Summary	17
5.3: Matrix Spike/Matrix Spike Duplicate Summary	18
Section 6: Metals Analysis - QC Data Summaries	19
6.1: Prep QC MP24976: Cd,Ca,Cu,Pb,Mg,Zn	20
Section 7: General Chemistry - QC Data Summaries	26
7.1: Method Blank and Spike Results Summary	27
7.2: Duplicate Results Summary	28
7.3: Matrix Spike Results Summary	29
7.4: Matrix Spike Duplicate Results Summary	30
Section 8: Misc. Forms (Accutest New Jersey)	31
8.1: Chain of Custody	32
Section 9: Metals Analysis - QC Data (Accutest New Jersey)	34
9.1: Prep QC MP71479: Hg	35

1

2

3

4

5

6

7

8

9



Sample Summary

BFA Environmental Consultants

Job No: FA3595

Orange County Dewatering Screening; FL
Project No: 3309/3365

Sample Number	Collected		Received	Matrix		Client Sample ID
	Date	Time By		Code	Type	
FA3595-1	04/11/13	12:43 DA	04/12/13	AQ	Ground Water	B-2
FA3595-2	04/11/13	15:02 DA	04/12/13	AQ	Ground Water	B-1

Summary of Hits

Job Number: FA3595
Account: BFA Environmental Consultants
Project: Orange County Dewatering Screening; FL
Collected: 04/11/13

Lab Sample ID	Client Sample ID	Result/ Qual	PQL	MDL	Units	Method
FA3595-1	B-2					
Calcium		43000	1000	50	ug/l	SW846 6010C
Magnesium		1030 I	5000	74	ug/l	SW846 6010C
Mercury ^a		2.4	0.50	0.28	ng/l	EPA 1631
Zinc		5.4 I	20	5.0	ug/l	SW846 6010C
Hardness, Total as CaCO ₃ ^b		112	23	0.43	mg/l	SM19 2340B
Total Organic Carbon		5.8	1.0	0.23	mg/l	SM19 5310B/SW 9060A
pH ^c		7.38			su	SM 4500H B/SW 9040C
FA3595-2	B-1					
Calcium		29700	1000	50	ug/l	SW846 6010C
Magnesium		1360 I	5000	74	ug/l	SW846 6010C
Mercury ^a		14.0	0.50	0.28	ng/l	EPA 1631
Zinc		12.3 I	20	5.0	ug/l	SW846 6010C
Hardness, Total as CaCO ₃ ^b		79.8	23	0.43	mg/l	SM19 2340B
Total Organic Carbon		17.1	1.0	0.23	mg/l	SM19 5310B/SW 9060A
pH ^c		5.86			su	SM 4500H B/SW 9040C

(a) Analysis performed at Accutest Laboratories, Dayton, NJ.

(b) Calculated as: (Calcium * 2.497) + (Magnesium * 4.118)

(c) Field analysis required. Received out of hold time and analyzed by request.

Sample Results

Report of Analysis

Report of Analysis

3.1
3

Client Sample ID: B-2	Date Sampled: 04/11/13
Lab Sample ID: FA3595-1	Date Received: 04/12/13
Matrix: AQ - Ground Water	Percent Solids: n/a
Method: SW846 8260B	
Project: Orange County Dewatering Screening; FL	

Run #	File ID	DF	Analyzed	By	Prep Date	Prep Batch	Analytical Batch
Run #1	O15629.D	1	04/23/13	MM	n/a	n/a	VO640
Run #2							

Run #	Purge Volume
Run #1	5.0 ml
Run #2	

CAS No.	Compound	Result	PQL	MDL	Units	Q
71-43-2	Benzene	0.21 U	1.0	0.21	ug/l	
91-20-3	Naphthalene	1.0 U	5.0	1.0	ug/l	

CAS No.	Surrogate Recoveries	Run# 1	Run# 2	Limits
1868-53-7	Dibromofluoromethane	104%		83-118%
17060-07-0	1,2-Dichloroethane-D4	108%		79-125%
2037-26-5	Toluene-D8	104%		85-112%
460-00-4	4-Bromofluorobenzene	105%		83-118%

U = Not detected MDL - Method Detection Limit
 PQL = Practical Quantitation Limit
 L = Indicates value exceeds calibration range

I = Result > = MDL but < PQL J = Estimated value
 V = Indicates analyte found in associated method blank
 N = Indicates presumptive evidence of a compound

Report of Analysis

Client Sample ID: B-2	Date Sampled: 04/11/13
Lab Sample ID: FA3595-1	Date Received: 04/12/13
Matrix: AQ - Ground Water	Percent Solids: n/a
Project: Orange County Dewatering Screening; FL	

Total Metals Analysis

Analyte	Result	PQL	MDL	Units	DF	Prep	Analyzed By	Method	Prep Method
Cadmium	0.50 U	5.0	0.50	ug/l	1	04/17/13	04/17/13 LM	SW846 6010C ¹	SW846 3010A ³
Calcium	43000	1000	50	ug/l	1	04/17/13	04/17/13 LM	SW846 6010C ¹	SW846 3010A ³
Copper	1.0 U	25	1.0	ug/l	1	04/17/13	04/17/13 LM	SW846 6010C ¹	SW846 3010A ³
Lead	1.1 U	5.0	1.1	ug/l	1	04/17/13	04/17/13 LM	SW846 6010C ¹	SW846 3010A ³
Magnesium	1030 I	5000	74	ug/l	1	04/17/13	04/17/13 LM	SW846 6010C ¹	SW846 3010A ³
Mercury ^a	2.4	0.50	0.28	ng/l	1	04/17/13	04/22/13 ANJ	EPA 1631 ²	EPA 1631 ⁴
Zinc	5.4 I	20	5.0	ug/l	1	04/17/13	04/17/13 LM	SW846 6010C ¹	SW846 3010A ³

(1) Instrument QC Batch: MA10685

(2) Instrument QC Batch: N:MA31019

(3) Prep QC Batch: MP24976

(4) Prep QC Batch: N:MP71479

(a) Analysis performed at Accutest Laboratories, Dayton, NJ.

PQL = Practical Quantitation Limit
MDL = Method Detection Limit

U = Indicates a result < MDL
I = Indicates a result > = MDL but < PQL

Report of Analysis

Client Sample ID: B-2 Lab Sample ID: FA3595-1 Matrix: AQ - Ground Water Project: Orange County Dewatering Screening; FL	Date Sampled: 04/11/13 Date Received: 04/12/13 Percent Solids: n/a
--	---

General Chemistry

Analyte	Result	PQL	MDL	Units	DF	Analyzed	By	Method
Chromium, Hexavalent	0.0080 U	0.010	0.0080	mg/l	1	04/12/13 11:37 FN	SW846	7196A
Hardness, Total as CaCO ₃ ^a	112	23	0.43	mg/l	1	04/17/13 20:02 LM	SM19	2340B
Total Organic Carbon	5.8	1.0	0.23	mg/l	1	04/17/13 11:39 FN	SM19	5310B/SW 9060A
pH ^b	7.38			su	1	04/12/13 12:25 HH	SM	4500H B/SW 9040C

(a) Calculated as: (Calcium * 2.497) + (Magnesium * 4.118)

(b) Field analysis required. Received out of hold time and analyzed by request.

PQL = Practical Quantitation Limit
 MDL = Method Detection Limit

U = Indicates a result < MDL
 I = Indicates a result > = MDL but < PQL

Report of Analysis

32
3

Client Sample ID: B-1	Date Sampled: 04/11/13
Lab Sample ID: FA3595-2	Date Received: 04/12/13
Matrix: AQ - Ground Water	Percent Solids: n/a
Method: SW846 8260B	
Project: Orange County Dewatering Screening; FL	

Run #	File ID	DF	Analyzed	By	Prep Date	Prep Batch	Analytical Batch
Run #1	O15630.D	1	04/23/13	MM	n/a	n/a	VO640
Run #2							

Run #	Purge Volume
Run #1	5.0 ml
Run #2	

CAS No.	Compound	Result	PQL	MDL	Units	Q
71-43-2	Benzene	0.21 U	1.0	0.21	ug/l	
91-20-3	Naphthalene	1.0 U	5.0	1.0	ug/l	

CAS No.	Surrogate Recoveries	Run# 1	Run# 2	Limits
1868-53-7	Dibromofluoromethane	106%		83-118%
17060-07-0	1,2-Dichloroethane-D4	109%		79-125%
2037-26-5	Toluene-D8	104%		85-112%
460-00-4	4-Bromofluorobenzene	104%		83-118%

U = Not detected MDL - Method Detection Limit
 PQL = Practical Quantitation Limit
 L = Indicates value exceeds calibration range

I = Result > = MDL but < PQL J = Estimated value
 V = Indicates analyte found in associated method blank
 N = Indicates presumptive evidence of a compound

Report of Analysis

Client Sample ID: B-1	Date Sampled: 04/11/13
Lab Sample ID: FA3595-2	Date Received: 04/12/13
Matrix: AQ - Ground Water	Percent Solids: n/a
Project: Orange County Dewatering Screening; FL	

Total Metals Analysis

Analyte	Result	PQL	MDL	Units	DF	Prep	Analyzed By	Method	Prep Method
Cadmium	0.50 U	5.0	0.50	ug/l	1	04/17/13	04/17/13 LM	SW846 6010C ¹	SW846 3010A ³
Calcium	29700	1000	50	ug/l	1	04/17/13	04/17/13 LM	SW846 6010C ¹	SW846 3010A ³
Copper	1.0 U	25	1.0	ug/l	1	04/17/13	04/17/13 LM	SW846 6010C ¹	SW846 3010A ³
Lead	1.1 U	5.0	1.1	ug/l	1	04/17/13	04/17/13 LM	SW846 6010C ¹	SW846 3010A ³
Magnesium	1360 I	5000	74	ug/l	1	04/17/13	04/17/13 LM	SW846 6010C ¹	SW846 3010A ³
Mercury ^a	14.0	0.50	0.28	ng/l	1	04/17/13	04/22/13 ANJ	EPA 1631 ²	EPA 1631 ⁴
Zinc	12.3 I	20	5.0	ug/l	1	04/17/13	04/17/13 LM	SW846 6010C ¹	SW846 3010A ³

- (1) Instrument QC Batch: MA10685
- (2) Instrument QC Batch: N:MA31019
- (3) Prep QC Batch: MP24976
- (4) Prep QC Batch: N:MP71479

(a) Analysis performed at Accutest Laboratories, Dayton, NJ.

PQL = Practical Quantitation Limit
 MDL = Method Detection Limit

U = Indicates a result < MDL
 I = Indicates a result > = MDL but < PQL

Report of Analysis

32
3

Client Sample ID: B-1	Date Sampled: 04/11/13
Lab Sample ID: FA3595-2	Date Received: 04/12/13
Matrix: AQ - Ground Water	Percent Solids: n/a
Project: Orange County Dewatering Screening; FL	

General Chemistry

Analyte	Result	PQL	MDL	Units	DF	Analyzed	By	Method
Chromium, Hexavalent	0.0080 U	0.010	0.0080	mg/l	1	04/12/13 11:37 FN	SW846	7196A
Hardness, Total as CaCO ₃ ^a	79.8	23	0.43	mg/l	1	04/17/13 20:26 LM	SM19	2340B
Total Organic Carbon	17.1	1.0	0.23	mg/l	1	04/17/13 11:54 FN	SM19	5310B/SW 9060A
pH ^b	5.86			su	1	04/12/13 12:25 HH	SM	4500H B/SW 9040C

(a) Calculated as: (Calcium * 2.497) + (Magnesium * 4.118)

(b) Field analysis required. Received out of hold time and analyzed by request.

PQL = Practical Quantitation Limit
MDL = Method Detection Limit

U = Indicates a result < MDL
I = Indicates a result > = MDL but < PQL

Misc. Forms

Custody Documents and Other Forms

Includes the following where applicable:

- Chain of Custody



Accutest Laboratories Southeast Chain of Custody

4405 Vineland Road, Suite C-15 Orlando, FL 32811
TEL: 407-425-6700 • FAX: 407-425-0707

Accutest JOB #

FA3595

PAGE 1 OF 1

Client / Reporting Information		Project Information		Analytical Information		Matrix Codes												
Company Name: BFA		Project Name: Pump Station 3309, 3365		Accutest Quote #		SKIFF#												
Address		Street		City		State												
City		State		City		State												
Project Contact		Project #		Project #		Project #												
Phone #		Fax #		Client Purchase Order #		Client Purchase Order #												
Sampler(s) Name(s) (Printed)		Client Purchase Order #		Client Purchase Order #		Client Purchase Order #												
Accutest Sample #	Field ID / Point of Collection	COLLECTION		CONTAINER INFORMATION											LAB USE ONLY			
		DATE	TIME	SAMPLED BY	MATRIX	TOTAL # OF BOTTLES	OTHER	WINE	PC	WCK	WCK	WCK	WCK	WCK		WCK	WCK	WCK
1	B-2	4.11.13	1243	DA (20)	B	3		X	X	X	X	X	X	X	X	X	X	X
2	B-1	4.11.13	1507	DA (20)	B	3		X	X	X	X	X	X	X	X	X	X	X

Handwritten notes in Analytical Information: VOC, TOC, PCB, PAH, Hex, Cd, Cu, Pb, Zn, LLMs

TURNAROUND TIME (Business Days)

10 Days Standard
 7 Day RUSH
 5 Day RUSH
 3 Day EMERGENCY
 2 Day EMERGENCY
 1 Day EMERGENCY
 OTHER

Data Deliverable Information

COMMERCIAL "A" (RESULTS ONLY)
 COMMERCIAL "B" (RESULTS PLUS QC)
 REDT1 (EPA LEVEL 3)
 FULT1 (EPA LEVEL 4)
 EDD'S

Chain of Custody

Relinquished by Sampler: 1 *[Signature]* Date Time: 4.11.13 1655 Received By: 2 *[Signature]* Date Time: 4.11.13 1655

Relinquished by: 3 *[Signature]* Date Time: 4.11.13 1655 Received By: 4 *[Signature]* Date Time: 04-12-13 800

Relinquished by: 5 *[Signature]* Date Time: 4.11.13 1655 Received By: 6 *[Signature]* Date Time: 4.11.13 1655

Relinquished by: 7 *[Signature]* Date Time: 4.11.13 1655 Received By: 8 *[Signature]* Date Time: 4.11.13 1655

Lab Use Only: Custody Seal in Place: Y N Temp Blank Provided: Y N Preserved where Applicable: Y N Total # of Coolers: Cooler Temperature (s) Celsius: 3.0

ACCUTEST LABORATORIES SAMPLE RECEIPT CONFIRMATION

ACCUTEST'S JOB NUMBER: FA3595 CLIENT: BFA PROJECT: Pump Station 3309, 3365
 DATE/TIME RECEIVED: 04-12-13 800 (MM/DD/YY 24:00) NUMBER OF COOLERS RECEIVED: 1
 METHOD OF DELIVERY: FEDEX UPS ACCUTEST COURIER GREYHOUND DELIVERY OTHER
 AIRBILL NUMBERS: _____

COOLER INFORMATION

- CUSTODY SEAL NOT PRESENT OR NOT INTACT
- CHAIN OF CUSTODY NOT RECEIVED (COC)
- ANALYSIS REQUESTED IS UNCLEAR OR MISSING
- SAMPLE DATES OR TIMES UNCLEAR OR MISSING
- TEMPERATURE CRITERIA NOT MET
- WET ICE PRESENT

TRIP BLANK INFORMATION

- TRIP BLANK PROVIDED
- TRIP BLANK NOT PROVIDED
- TRIP BLANK NOT ON COC
- TRIP BLANK INTACT
- TRIP BLANK NOT INTACT
- RECEIVED WATER TRIP BLANK (2)
- RECEIVED SOIL TRIP BLANK

MISC. INFORMATION

NUMBER OF ENCORES? 25-GRAM _____ 5-GRAM _____
 NUMBER OF 5035 FIELD KITS? _____
 NUMBER OF LAB FILTERED METALS? _____

TEMPERATURE INFORMATION

- IR THERM ID 3 CORR. FACTOR to 4
- OBSERVED TEMPS: 2.6
- CORRECTED TEMPS: 3.0

SAMPLE INFORMATION

- SAMPLE LABELS PRESENT ON ALL BOTTLES
- INCORRECT NUMBER OF CONTAINERS USED
- SAMPLE RECEIVED IMPROPERLY PRESERVED
- INSUFFICIENT VOLUME FOR ANALYSIS
- DATES/TIMES ON COC DO NOT MATCH SAMPLE LABEL
- ID'S ON COC DO NOT MATCH LABEL
- VOC VIALS HAVE HEADSPACE (MACRO BUBBLES)
- BOTTLES RECEIVED BUT ANALYSIS NOT REQUESTED
- NO BOTTLES RECEIVED FOR ANALYSIS REQUESTED
- UNCLEAR FILTERING OR COMPOSITING INSTRUCTIONS
- SAMPLE CONTAINER(S) RECEIVED BROKEN
- % SOLIDS JAR NOT RECEIVED
- 5035 FIELD KIT FROZEN WITHIN 48 HOUR'S
- RESIDUAL CHLORINE PRESENT

(APPLICABLE TO EPA 600 SERIES OR NORTH CAROLINA ORGANICS)

SUMMARY OF COMMENTS: _____

TECHNICIAN SIGNATURE/DATE

R. Williams 04/12-13

REVIEWER SIGNATURE/DATE

[Signature] 04/12/13

NF 12/10

receipt confirmation 122910.xls

GC/MS Volatiles

5

QC Data Summaries

Includes the following where applicable:

- Method Blank Summaries
- Blank Spike Summaries
- Matrix Spike and Duplicate Summaries

Method Blank Summary

Job Number: FA3595
Account: BFACFLO BFA Environmental Consultants
Project: Orange County Dewatering Screening; FL

Sample	File ID	DF	Analyzed	By	Prep Date	Prep Batch	Analytical Batch
VO640-MB	O15623.D	1	04/23/13	MM	n/a	n/a	VO640

The QC reported here applies to the following samples:

Method: SW846 8260B

FA3595-1, FA3595-2

CAS No.	Compound	Result	RL	MDL	Units	Q
71-43-2	Benzene	ND	1.0	0.21	ug/l	
91-20-3	Naphthalene	ND	5.0	1.0	ug/l	

CAS No.	Surrogate Recoveries	Limits	
1868-53-7	Dibromofluoromethane	104%	83-118%
17060-07-0	1,2-Dichloroethane-D4	104%	79-125%
2037-26-5	Toluene-D8	101%	85-112%
460-00-4	4-Bromofluorobenzene	101%	83-118%

5.1.1
5

Blank Spike Summary

Job Number: FA3595
Account: BFACFLO BFA Environmental Consultants
Project: Orange County Dewatering Screening; FL

Sample	File ID	DF	Analyzed	By	Prep Date	Prep Batch	Analytical Batch
VO640-BS	O15622.D	1	04/23/13	MM	n/a	n/a	VO640

The QC reported here applies to the following samples:

Method: SW846 8260B

FA3595-1, FA3595-2

CAS No.	Compound	Spike ug/l	BSP ug/l	BSP %	Limits
71-43-2	Benzene	25	25.7	103	81-122
91-20-3	Naphthalene	25	19.2	77	63-132

CAS No.	Surrogate Recoveries	BSP	Limits
1868-53-7	Dibromofluoromethane	103%	83-118%
17060-07-0	1,2-Dichloroethane-D4	103%	79-125%
2037-26-5	Toluene-D8	97%	85-112%
460-00-4	4-Bromofluorobenzene	98%	83-118%

* = Outside of Control Limits.

Matrix Spike/Matrix Spike Duplicate Summary

Job Number: FA3595
Account: BFACFLO BFA Environmental Consultants
Project: Orange County Dewatering Screening; FL

Sample	File ID	DF	Analyzed	By	Prep Date	Prep Batch	Analytical Batch
FA3878-1MS	O15644.D	1	04/23/13	MM	n/a	n/a	VO640
FA3878-1MSD	O15645.D	1	04/23/13	MM	n/a	n/a	VO640
FA3878-1	O15631.D	1	04/23/13	MM	n/a	n/a	VO640

The QC reported here applies to the following samples:

Method: SW846 8260B

FA3595-1, FA3595-2

CAS No.	Compound	FA3878-1 ug/l	Spike Q ug/l	MS ug/l	MS %	MSD ug/l	MSD %	RPD	Limits Rec/RPD
71-43-2	Benzene	0.49	25	27.0	106	26.4	104	2	81-122/14
91-20-3	Naphthalene	5.0 U	25	17.8	71	20.8	83	16	63-132/25

CAS No.	Surrogate Recoveries	MS	MSD	FA3878-1	Limits
1868-53-7	Dibromofluoromethane	105%	106%	107%	83-118%
17060-07-0	1,2-Dichloroethane-D4	108%	107%	111%	79-125%
2037-26-5	Toluene-D8	93%	96%	102%	85-112%
460-00-4	4-Bromofluorobenzene	98%	98%	106%	83-118%

* = Outside of Control Limits.

5.3.1
 5

Metals Analysis

QC Data Summaries

Includes the following where applicable:

- Method Blank Summaries
- Matrix Spike and Duplicate Summaries
- Blank Spike and Lab Control Sample Summaries
- Serial Dilution Summaries

BLANK RESULTS SUMMARY
Part 2 - Method Blanks

Login Number: FA3595
Account: BFACFLO - BFA Environmental Consultants
Project: Orange County Dewatering Screening; FL

QC Batch ID: MP24976
Matrix Type: AQUEOUS

Methods: SW846 6010C
Units: ug/l

Prep Date: 04/17/13 04/17/13

Metal	RL	IDL	MDL	MB raw	final	MB raw	final
Aluminum	200	15	15				
Antimony	6.0	1.3	1.3				
Arsenic	10	1.6	2.5				
Barium	200	1	1				
Beryllium	4.0	.5	.5				
Cadmium	5.0	.5	.5	0.0	<5.0	-0.10	<5.0
Calcium	1000	50	50	2.2	<1000	3.7	<1000
Chromium	10	1.8	2				
Cobalt	50	.5	.5				
Copper	25	1	1	0.70	<25	0.20	<25
Iron	300	29	29				
Lead	5.0	1.1	1.1	-0.30	<5.0	-0.60	<5.0
Magnesium	5000	74	74	-2.8	<5000	9.5	<5000
Manganese	15	.7	.7				
Molybdenum	50	.6	1				
Nickel	40	.5	.5				
Potassium	10000	200	200				
Selenium	10	2	2				
Silver	10	.5	.5				
Sodium	10000	500	500				
Strontium	10	.5	.5				
Thallium	10	1.3	1.3				
Tin	50	.7	1.8				
Titanium	10	.9	1				
Vanadium	50	.5	1				
Zinc	20	3	5	2.2	<20	5.1	<20

Associated samples MP24976: FA3595-1, FA3595-2

Results < IDL are shown as zero for calculation purposes
(*) Outside of QC limits
(anr) Analyte not requested

6.1.1
6

MATRIX SPIKE AND DUPLICATE RESULTS SUMMARY

Login Number: FA3595
 Account: BFACFLO - BFA Environmental Consultants
 Project: Orange County Dewatering Screening; FL

QC Batch ID: MP24976
 Matrix Type: AQUEOUS

Methods: SW846 6010C
 Units: ug/l

Prep Date: 04/17/13 04/17/13

Metal	FA3595-1 Original	DUP	RPD	QC Limits	FA3595-1 Original MS	Spikelot MPFLICP1	% Rec	QC Limits	
Aluminum									
Antimony									
Arsenic	anr								
Barium									
Beryllium									
Cadmium	0.0	0.0	NC	0-20	0.0	48.2	50	96.4	80-120
Calcium	43000	43600	1.4	0-20	43000	68200	25000	100.8	80-120
Chromium									
Cobalt									
Copper	0.0	0.0	NC	0-20	0.0	252	250	100.8	80-120
Iron									
Lead	0.0	0.0	NC	0-20	0.0	458	500	91.6	80-120
Magnesium	1030	1060	2.9	0-20	1030	25000	25000	95.9	80-120
Manganese									
Molybdenum									
Nickel									
Potassium									
Selenium									
Silver									
Sodium	anr								
Strontium									
Thallium									
Tin									
Titanium									
Vanadium									
Zinc	5.4	5.2	3.8	0-20	5.4	495	500	97.9	80-120

Associated samples MP24976: FA3595-1, FA3595-2

Results < IDL are shown as zero for calculation purposes
 (*) Outside of QC limits
 (N) Matrix Spike Rec. outside of QC limits
 (anr) Analyte not requested

6.1.2
 6

MATRIX SPIKE AND DUPLICATE RESULTS SUMMARY

Login Number: FA3595
 Account: BFACFLO - BFA Environmental Consultants
 Project: Orange County Dewatering Screening; FL

QC Batch ID: MP24976
 Matrix Type: AQUEOUS

Methods: SW846 6010C
 Units: ug/l

Prep Date: 04/17/13

Metal	FA3595-1 Original	MSD	Spike/lot MPFLICP1	% Rec	MSD RPD	QC Limit
Aluminum						
Antimony						
Arsenic	anr					
Barium						
Beryllium						
Cadmium	0.0	47.6	50	95.2	1.3	20
Calcium	43000	66300	25000	93.2	2.8	20
Chromium						
Cobalt						
Copper	0.0	251	250	100.4	0.4	20
Iron						
Lead	0.0	446	500	89.2	2.7	20
Magnesium	1030	24700	25000	94.7	1.2	20
Manganese						
Molybdenum						
Nickel						
Potassium						
Selenium						
Silver						
Sodium	anr					
Strontium						
Thallium						
Tin						
Titanium						
Vanadium						
Zinc	5.4	485	500	95.9	2.0	20

Associated samples MP24976: FA3595-1, FA3595-2

Results < IDL are shown as zero for calculation purposes
 (*) Outside of QC limits
 (N) Matrix Spike Rec. outside of QC limits
 (anr) Analyte not requested

6.1.2
 6

SPIKE BLANK AND LAB CONTROL SAMPLE SUMMARY

Login Number: FA3595
 Account: BFACFLO - BFA Environmental Consultants
 Project: Orange County Dewatering Screening; FL

QC Batch ID: MP24976
 Matrix Type: AQUEOUS

Methods: SW846 6010C
 Units: ug/l

Prep Date: 04/17/13

Metal	BSP Result	Spikelot MPFLICP1	% Rec	QC Limits
Aluminum				
Antimony				
Arsenic	anr			
Barium				
Beryllium				
Cadmium	49.2	50	98.4	80-120
Calcium	24900	25000	99.6	80-120
Chromium				
Cobalt				
Copper	256	250	102.4	80-120
Iron				
Lead	449	500	89.8	80-120
Magnesium	24500	25000	98.0	80-120
Manganese				
Molybdenum				
Nickel				
Potassium				
Selenium				
Silver				
Sodium	anr			
Strontium				
Thallium				
Tin				
Titanium				
Vanadium				
Zinc	494	500	98.8	80-120

Associated samples MP24976: FA3595-1, FA3595-2

Results < IDL are shown as zero for calculation purposes
 (*) Outside of QC limits
 (anr) Analyte not requested

6.1.3
 6

SERIAL DILUTION RESULTS SUMMARY

Login Number: FA3595
 Account: BFACFLO - BFA Environmental Consultants
 Project: Orange County Dewatering Screening; FL

QC Batch ID: MP24976
 Matrix Type: AQUEOUS

Methods: SW846 6010C
 Units: ug/l

Prep Date: 04/17/13

Metal	FA3595-1 Original	SDL 1:5	%DIF	QC Limits
Aluminum				
Antimony				
Arsenic	anr			
Barium				
Beryllium				
Cadmium	0.00	0.00	NC	0-10
Calcium	43000	44100	2.6	0-10
Chromium				
Cobalt				
Copper	0.00	0.00	NC	0-10
Iron				
Lead	0.00	0.00	NC	0-10
Magnesium	1030	1080	5.1	0-10
Manganese				
Molybdenum				
Nickel				
Potassium				
Selenium				
Silver				
Sodium	anr			
Strontium				
Thallium				
Tin				
Titanium				
Vanadium				
Zinc	5.40	0.00	100.0(a)	0-10

Associated samples MP24976: FA3595-1, FA3595-2

Results < IDL are shown as zero for calculation purposes

(*) Outside of QC limits

(anr) Analyte not requested

(a) Percent difference acceptable due to low initial sample concentration (< 50 times IDL).

POST DIGESTATE SPIKE SUMMARY

Login Number: FA3595
 Account: BFACFLO - BFA Environmental Consultants
 Project: Orange County Dewatering Screening; FL

QC Batch ID: MP24976
 Matrix Type: AQUEOUS

Methods: SW846 6010C
 Units: ug/l

Prep Date:

04/17/13

Metal	Sample ml	Final ml	FA3595-1 Raw	FA3595-1 Corr.**	PS ug/l	Spike ml	Spike ug/ml	Spike ug/l	% Rec	QC Limits
Aluminum										
Antimony										
Arsenic										
Barium										
Beryllium										
Cadmium	9.8	10	0	0	49.8	0.2	2.5	50	99.6	80-120
Calcium	9.8	10	43000	42140	47770	0.2	250	5000	112.6	80-120
Chromium										
Cobalt										
Copper	9.8	10	0	0	101.6	0.2	5	100	101.6	80-120
Iron										
Lead	9.8	10	0	0	43.7	0.2	2.5	50	87.4	80-120
Magnesium	9.8	10	1029	1008.42	5792	0.2	250	5000	95.7	80-120
Manganese										
Molybdenum										
Nickel										
Potassium										
Selenium										
Silver										
Sodium										
Strontium										
Thallium										
Tin										
Titanium										
Vanadium										
Zinc	9.8	10	5.4	5.292	293.5	0.2	12.5	250	115.3	80-120

Associated samples MP24976: FA3595-1, FA3595-2

Results < IDL are shown as zero for calculation purposes
 (*) Outside of QC limits
 (**) Corr. sample result = Raw * (sample volume / final volume)
 (anr) Analyte not requested

General Chemistry

QC Data Summaries

Includes the following where applicable:

- Method Blank and Blank Spike Summaries
- Duplicate Summaries
- Matrix Spike Summaries

METHOD BLANK AND SPIKE RESULTS SUMMARY
GENERAL CHEMISTRY

Login Number: FA3595
Account: BFACFLO - BFA Environmental Consultants
Project: Orange County Dewatering Screening; FL

Analyte	Batch ID	RL	MB Result	Units	Spike Amount	BSP Result	BSP %Recov	QC Limits
Chromium, Hexavalent	GN55207	0.010	0.0	mg/l	0.100	0.11	104.5	78-120%
Total Organic Carbon	GP21470/GN55275	1.0	0.0	mg/l	15	15.3	102.0	90-110%

Associated Samples:

Batch GN55207: FA3595-1, FA3595-2

Batch GP21470: FA3595-1, FA3595-2

(*) Outside of QC limits

7.1
7

DUPLICATE RESULTS SUMMARY
GENERAL CHEMISTRY

Login Number: FA3595
Account: BFACFLO - BFA Environmental Consultants
Project: Orange County Dewatering Screening; FL

Analyte	Batch ID	QC Sample	Units	Original Result	DUP Result	RPD	QC Limits
Total Organic Carbon	GP21470/GN55275	FA3598-1F	mg/l	41.8	42.6	1.9	0-20%
pH	GN55209	FA3595-1	su	7.38	7.34	0.5	0-10%

Associated Samples:

Batch GN55209: FA3595-1, FA3595-2

Batch GP21470: FA3595-1, FA3595-2

(*) Outside of QC limits

MATRIX SPIKE RESULTS SUMMARY
GENERAL CHEMISTRY

Login Number: FA3595
Account: BFACFLO - BFA Environmental Consultants
Project: Orange County Dewatering Screening; FL

Analyte	Batch ID	QC Sample	Units	Original Result	Spike Amount	MS Result	%Rec	QC Limits
Chromium, Hexavalent	GN55207	FA3595-2	mg/l	0.0080 U	0.100	0.054	54.4*(a)	78-120%
Total Organic Carbon	GP21470/GN55275	FA3598-1F	mg/l	41.8	15	51.6	65.3N(a)	90-110%

Associated Samples:

Batch GN55207: FA3595-1, FA3595-2

Batch GP21470: FA3595-1, FA3595-2

(*) Outside of QC limits

(N) Matrix Spike Rec. outside of QC limits

(a) Spike recovery indicates possible matrix interference.

7.3

7

MATRIX SPIKE DUPLICATE RESULTS SUMMARY
GENERAL CHEMISTRY

Login Number: FA3595
Account: BFACFLO - BFA Environmental Consultants
Project: Orange County Dewatering Screening; FL

Analyte	Batch ID	QC Sample	Units	Original Result	Spike Amount	MSD Result	RPD	QC Limit
Chromium, Hexavalent	GN55207	FA3595-2	mg/l	0.0080 U	0.100	0.0550	2.0	34%

Associated Samples:

Batch GN55207: FA3595-1, FA3595-2

(*) Outside of QC limits

(N) Matrix Spike Rec. outside of QC limits

Misc. Forms

Custody Documents and Other Forms

(Accutest New Jersey)

Includes the following where applicable:

- Chain of Custody



Accutest Laboratories Southeast Subcontract Chain of Custody

4405 Vineyard Blvd., Suite C-3, Orlando, FL 32811
TEL: 407-425-6700 FAX: 407-425-0707

Client / Reporting Information				Project Information				Analytical Information				Matrix Codes			
Company Name: Accutest Laboratories				Project Name: FA3595								CA - Drinking Water CW - Ground Water WW - Wastewater SW - Surface Water SO - Soil SL - Sludge O - Oil LC - Other Liquid AR - Air SC - Other Solid NP - N/A			
Address: 4405 Vineyard Rd.				Please send report to dawnd@accutest.com											
City: Orlando State: FL Zip: 32811				For any other issues contact munam@accutest.com											
Phone #: (407) 425-6700 Fax#: (407) 425-0707															
Lab ID #		Sample ID		COLLECTOR				CONTAINER INFORMATION				LAB USE ONLY			
		DATE	TIME	SAMPLED BY	MATRIX	TOTAL # OF BOTTLES	OTHER	ADMS	USE	APPL	INSTR	INSTR	INSTR	INSTR	INSTR
Turnaround Time (Business days)				Data Deliverable Information				Comments / Remarks							
Std. 10 Business Days 7 Day RUSH 5 Day RUSH 3 Day EMERGENCY 2 Day EMERGENCY 1 Day EMERGENCY Other				Approved By: / Date/Rush Code: <input type="checkbox"/> COMMERCIAL "A" (RESULTS ONLY) <input checked="" type="checkbox"/> COMMERCIAL "B" (RESULTS PLUS QC) <input type="checkbox"/> REDT1 (EPA LEVEL 3) <input type="checkbox"/> FULLT1 (EPA LEVEL 4) <input type="checkbox"/> EDD'S				Ship to Laboratory - ALNS Approved by - Munam TRK# 79952698799							
Sample Custody must be documented below each time samples change possession, including courier delivery.															
Relinquished By/Sampler/Affiliation		Date Time		Received By/Affiliation		Date Time		Relinquished By/Affiliation		Date Time		Received By/Affiliation			
1 <i>R. Miller</i> / <i>SLWB</i>		04/15/13		2 <i>FP</i>				3 <i>FR</i>		4/16/13 6:00		4 <i>ALNS</i>			
5				6				7				8			
Lab Use Only: Custody Seal in Place: Y/N Temp Blank Provided: Y/N Preserved Where Applicable: Y/N Total # of Coolers: 1 Cooler Temperature (s) Celsius: 40°C															

11

8.1
8

FA3595: Chain of Custody
Page 1 of 2
Accutest New Jersey

Accutest Laboratories Sample Receipt Summary

Accutest Job Number: FA3595 **Client:** _____ **Project:** _____
Date / Time Received: 4/16/2013 **Delivery Method:** _____ **Airbill #s:** _____

Cooler Temps (Initial/Adjusted): #1: (4/4); 0

<u>Cooler Security</u>	<u>Y or N</u>		<u>Y or N</u>
1. Custody Seals Present:	<input checked="" type="checkbox"/> <input type="checkbox"/>	3. COC Present:	<input checked="" type="checkbox"/> <input type="checkbox"/>
2. Custody Seals Intact:	<input checked="" type="checkbox"/> <input type="checkbox"/>	4. Smpl Dates/Time OK	<input checked="" type="checkbox"/> <input type="checkbox"/>

<u>Cooler Temperature</u>	<u>Y or N</u>
1. Temp criteria achieved:	<input checked="" type="checkbox"/> <input type="checkbox"/>
2. Cooler temp verification:	Bar Therm
3. Cooler media:	Ice (Bag)
4. No. Coolers:	1

<u>Quality Control Preservation</u>	<u>Y</u>	<u>or</u>	<u>N</u>	<u>N/A</u>
1. Trip Blank present / cooler:	<input type="checkbox"/>	<input checked="" type="checkbox"/>	<input type="checkbox"/>	<input type="checkbox"/>
2. Trip Blank listed on COC:	<input type="checkbox"/>	<input checked="" type="checkbox"/>	<input type="checkbox"/>	<input type="checkbox"/>
3. Samples preserved properly:	<input checked="" type="checkbox"/>	<input type="checkbox"/>	<input type="checkbox"/>	<input type="checkbox"/>
4. VOCs headspace free:	<input type="checkbox"/>	<input type="checkbox"/>	<input type="checkbox"/>	<input checked="" type="checkbox"/>

<u>Sample Integrity - Documentation</u>	<u>Y</u>	<u>or</u>	<u>N</u>
1. Sample labels present on bottles:	<input checked="" type="checkbox"/>	<input type="checkbox"/>	<input type="checkbox"/>
2. Container labeling complete:	<input checked="" type="checkbox"/>	<input type="checkbox"/>	<input type="checkbox"/>
3. Sample container label / COC agree:	<input checked="" type="checkbox"/>	<input type="checkbox"/>	<input type="checkbox"/>

<u>Sample Integrity - Condition</u>	<u>Y</u>	<u>or</u>	<u>N</u>
1. Sample recvd within HT:	<input checked="" type="checkbox"/>	<input type="checkbox"/>	<input type="checkbox"/>
2. All containers accounted for:	<input checked="" type="checkbox"/>	<input type="checkbox"/>	<input type="checkbox"/>
3. Condition of sample:	Intact		

<u>Sample Integrity - Instructions</u>	<u>Y</u>	<u>or</u>	<u>N</u>	<u>N/A</u>
1. Analysis requested is clear:	<input checked="" type="checkbox"/>	<input type="checkbox"/>	<input type="checkbox"/>	<input type="checkbox"/>
2. Bottles received for unspecified tests	<input type="checkbox"/>	<input type="checkbox"/>	<input checked="" type="checkbox"/>	<input type="checkbox"/>
3. Sufficient volume recvd for analysis:	<input checked="" type="checkbox"/>	<input type="checkbox"/>	<input type="checkbox"/>	<input type="checkbox"/>
4. Compositing instructions clear:	<input type="checkbox"/>	<input type="checkbox"/>	<input type="checkbox"/>	<input checked="" type="checkbox"/>
5. Filtering instructions clear:	<input type="checkbox"/>	<input type="checkbox"/>	<input type="checkbox"/>	<input checked="" type="checkbox"/>

Comments

Metals Analysis

QC Data Summaries

(Accutest New Jersey)

Includes the following where applicable:

- Method Blank Summaries
- Matrix Spike and Duplicate Summaries
- Blank Spike and Lab Control Sample Summaries
- Serial Dilution Summaries

BLANK RESULTS SUMMARY
Part 2 - Method Blanks

Login Number: FA3595

Account: ALSE - Accutest Laboratories Southeast, Inc.
Project: BFACFLO: Orange County Dewatering Screening; FL

QC Batch ID: MP71479
Matrix Type: AQUEOUS

Methods: EPA 1631
Units: ng/l

Prep Date: 04/17/13

Metal	RL	IDL	MDL	MB raw	final
Mercury	0.50	.086	.28	-0.052	<0.50

Associated samples MP71479: FA3595-1, FA3595-2

Results < IDL are shown as zero for calculation purposes
(*) Outside of QC limits
(anr) Analyte not requested

MATRIX SPIKE AND DUPLICATE RESULTS SUMMARY

Login Number: FA3595
 Account: ALSE - Accutest Laboratories Southeast, Inc.
 Project: BFACFLO: Orange County Dewatering Screening; FL

QC Batch ID: MP71479
 Matrix Type: AQUEOUS

Methods: EPA 1631
 Units: ng/l

Prep Date: 04/20/13

Metal	FA3595-2 Original MS	Spikelot HGLL1	% Rec	QC Limits
-------	-------------------------	-------------------	-------	--------------

Mercury	14.0	21.3	5	146.0N(a) 71-125
---------	------	------	---	------------------

Associated samples MP71479: FA3595-1, FA3595-2

Results < IDL are shown as zero for calculation purposes
 (*) Outside of QC limits
 (N) Matrix Spike Rec. outside of QC limits
 (anr) Analyte not requested
 (a) Spike recovery indicates possible matrix interference.

MATRIX SPIKE AND DUPLICATE RESULTS SUMMARY

Login Number: FA3595
 Account: ALSE - Accutest Laboratories Southeast, Inc.
 Project: BFACFLO: Orange County Dewatering Screening; FL

QC Batch ID: MP71479
 Matrix Type: AQUEOUS

Methods: EPA 1631
 Units: ng/l

Prep Date: 04/20/13

Metal	FA3595-2 Original	MSD	Spike lot	HGLL1	% Rec	MSD RPD	QC Limit
Mercury	14.0	20.1	5	122.0	5.8	24	

Associated samples MP71479: FA3595-1, FA3595-2

Results < IDL are shown as zero for calculation purposes
 (*) Outside of QC limits
 (N) Matrix Spike Rec. outside of QC limits
 (anr) Analyte not requested

SPIKE BLANK AND LAB CONTROL SAMPLE SUMMARY

Login Number: FA3595

Account: ALSE - Accutest Laboratories Southeast, Inc.
Project: BFACFLO: Orange County Dewatering Screening; FL

QC Batch ID: MP71479
Matrix Type: AQUEOUS

Methods: EPA 1631
Units: ng/l

Prep Date: 04/18/13

Metal	LCS Result	Spikelot HGLL1	% Rec	QC Limits
Mercury	5.4	5	108.0	77-123

Associated samples MP71479: FA3595-1, FA3595-2

Results < IDL are shown as zero for calculation purposes
(*) Outside of QC limits
(anr) Analyte not requested

APPENDIX B

FORMS

Digital Data Submission

February 11, 2011

This form is to be utilized for the submittal of digital data in accordance with the requirements outlined in Chapter 2111, "Project Documents and Submittals".

Date of Submittal: _____

Project Number: _____

Project Name: _____

Project Manager: _____

Consulting Firm: _____

Address: _____

City: _____ State: _____ Zip: _____

Phone: _____ Email: _____

Type of Submittal: Construction Plans Record Drawings

File Format: _____

APPENDIX B

ORANGE COUNTY UTILITIES

FORMS

- **Digital Data Submission**
- **Pressure Test**
- **Pump Station Start-up**

APPENDIX B

FORMS

Pressure Test

February 11, 2011

Project Name: _____						<input type="checkbox"/> Force Main <input type="checkbox"/> Reclaimed Main <input type="checkbox"/> Water Main		Allowable Loss – 2 Hours $L = \frac{SD(P)}{1/2}$ 148,000 <i>See Note Below</i>										
Constructed by: _____																		
DATE	LINE SEGMENT	STATION		LENGTH	N	D	START		END		LOSS (gal)		Pass /Fail STATUS					
		From	To				Time	PSI	Time	PSI	Allow	Actual						
COUNTY Inspector's Name:						Signature:						Date:						
Tester's Name:						Signature:						Date:						
Comments:																		

Note: L - Allowable leakage in gallons per hour.
 S - Length of pipe tested, in feet.
 D - Nominal diameter of the pipe in inches.
 P - Average test pressure during leakage test in pounds per square inch gauge.

APPENDIX C

ORANGE COUNTY UTILITIES

PERMITS OBTAINED BY COUNTY

- **FDEP Permit PS #3365 (University at Rouse) – Included**
- **FDEP Permit PS #3309 (Lena Street) – Not Required**
- **FDEP Permit PS #3893 (Allison Oaks) – Included**
- **FDEP Permit PS #3887 (Greenview Pines) – Included**
- **FDEP Permit PS #3890 (Bradford Cove) – Not Required**



FLORIDA DEPARTMENT OF ENVIRONMENTAL PROTECTION

Central District
3319 Maguire Boulevard, Suite 232
Orlando, Florida 32803-3767

RICK SCOTT
GOVERNOR

JENNIFER CARROLL
LT. GOVERNOR

HERSCHEL T. VINYARD JR.
SECRETARY

NOTICE OF PERMIT ISSUANCE

Sent via email: jim.broome@ocfl.net

In the Matter of an
Application for Permit by:

ORANGE COUNTY UTILITIES DEPARTMENT
9150 CURRY FORD ROAD
2ND FLOOR
ORLANDO FL 32825

ATTENTION JAMES N BROOME PE
CHIEF ENGINEER

Orange County - CS
Allison Oaks (PS #3893A) and Greenview Pines (PS#3887)
Connected to: OCUD/Eastern WRF - FL0038849

Dear Mr. Broome:

Enclosed is Permit Number CS48-0316825-001 to construct a sewage collection/transmission system, issued pursuant to 403.087(1), Florida Statutes.

The Department's proposed agency action shall become final unless a timely petition for an administrative hearing is filed under Sections 120.569 and 120.57, Florida Statutes, within fourteen days of receipt of notice. The procedures for petitioning for a hearing are set forth below.

A person whose substantial interests are affected by the Department's proposed permitting decision may petition for an administrative proceeding (hearing) under Sections 120.569 and 120.57, Florida Statutes. The petition must contain the information set forth below and must be filed (received by the clerk) in the Office of General Counsel of the Department at 3900 Commonwealth Boulevard, Mail Station 35, Tallahassee, Florida 32399-3000.

Petitions by the applicant or any of the persons listed below must be filed within fourteen days of receipt of this written notice. Petitions filed by any persons other than those entitled to written notice under Section 120.60(3), Florida Statutes, must be filed within fourteen days of publication of the notice or within fourteen days of receipt of the written notice, whichever occurs first. Under Section 120.60(3), Florida Statutes, however, any person who has asked the Department for notice of agency action may file a petition within fourteen days of receipt of such notice, regardless of the date of publication.

The petitioner shall mail a copy of the petition to the applicant at the address indicated above at the time of filing. The failure of any person to file a petition within fourteen days of receipt of notice shall constitute a waiver of that person's right to request an administrative determination (hearing) under Sections 120.569 and 120.57, Florida Statutes. Any subsequent intervention (in a proceeding initiated by another party) will be only at the discretion of the presiding officer upon the filing of a motion in compliance with Rule 28-106.205, Florida Administrative Code.

A petition that disputes the material facts on which the Department's action is based must contain the following information:

- (a) The name, address, and telephone number of each petitioner; the name, address, and telephone number of the petitioner's representative, if any; the Department permit identification number and the county in which the subject matter or activity is located;
- (b) A statement of how and when each petitioner received notice of the Department action;
- (c) A statement of how each petitioner's substantial interests are affected by the Department action;
- (d) A statement of all disputed issues of material fact. If there are none, the petition must so indicate;
- (e) A statement of facts that the petitioner contends warrant reversal or modification of the Department action;
- (f) A concise statement of the ultimate facts alleged, as well as the rules and statutes which entitle the petitioner to relief; and
- (g) A statement of the relief sought by the petitioner, stating precisely the action that the petitioner wants the Department to take.

Because the administrative hearing process is designed to formulate final agency action, the filing of a petition means that the Department's final action may be different from the position taken by it in this notice. Persons whose substantial interests will be affected by any such final decision of the Department have the right to petition to become a party to the proceeding, in accordance with the requirements set forth above.

Mediation under Section 120.573, Florida Statutes, is not available for this proceeding.

This permit action is final and effective on the date filed with the clerk of the Department unless a petition is filed in accordance with the above. Upon the timely filing of a petition this permit will not be effective until further order of the Department.

Any party to the permit has the right to seek judicial review of the permit action under Section 120.68, Florida Statutes, by the filing of a notice of appeal under Rules 9.110 and 9.190, Florida Rules of Appellate Procedure, with the clerk of the Department in the Office of General Counsel, Mail Station 35, 3900 Commonwealth Boulevard, Tallahassee, Florida, 32399-3000; and by filing a copy of the notice of appeal accompanied by the applicable filing fees with the appropriate district court of appeal. The notice of appeal must be filed within 30 days from the date when this permit action is filed with the clerk of the Department.



**FLORIDA DEPARTMENT OF
ENVIRONMENTAL PROTECTION**

Central District
3319 Maguire Boulevard, Suite 232
Orlando, Florida 32803-3767

RICK SCOTT
GOVERNOR

JENNIFER CARROLL
LT. GOVERNOR

HERSCHEL T. VINYARD JR.
SECRETARY

**STATE OF FLORIDA
DOMESTIC WASTEWATER COLLECTION/TRANSMISSION INDIVIDUAL PERMIT**

Permittee:
ORANGE COUNTY UTILITIES DEPARTMENT
9150 CURRY FORD ROAD
2ND FLOOR
ORLANDO FL 32825

Attention: James N Broome, P.E.
Chief Engineer

Permit Number: CS48-0316825-001
Date of Issue: March 13, 2013
Expiration Date: March 12, 2018
County: Orange
Project: Allison Oaks (PS #3893A) and
Greenview Pines (PS#3887)
Connected to: OCUD/Eastern WRF -
FL0038849

This permit is issued under the provisions of Chapter 403, Florida Statutes (F.S.), and Chapters 62-4 and 62-604, Florida Administrative Code (F.A.C.).

The above named permittee is hereby authorized to construct the facilities shown on the application and other documents on file with the Department and made a part hereof and specifically described as follows:

DESCRIPTION OF PROJECT:

Construction of a sewage collection/transmission system for the Allison Oaks (PS #3893A) and Greenview Pines (PS#3887) project to serve existing development generating no new flows.

The sewage collection/transmission system shall consist of: (A) 296 LF of 8 inch PVC gravity mains, (B) 90 LF of 4 inch PVC force mains, (C) one lift station with two submersible pumps operating at 100 gpm, (D) second rehabilitated lift station with two new submersibles pumps operating at 100 gpm, and (E) associated manholes, valves and other appurtenances .

LOCATION OF PROJECT: 3120 Patel Drive and 3695 Greenview Pines Court respectively, Winter Park, Orange County, Florida.

IN ACCORDANCE WITH: The limitations, requirements and other conditions set forth in pages 1 through 3 of this permit.

Permittee:
ORANGE COUNTY UTILITIES DEPARTMENT

Permit Number: CS48-0316825-001
Expiration Date: March 12, 2018

Attention: James N Broome, P.E.
Chief Engineer

PERMIT CONDITIONS:

1. This permit is subject to the general conditions of Rule 62-4.160, F.A.C., as applicable. This rule is available at the Department's Internet site at:
<http://www.dep.state.fl.us/water/wastewater/rules.htm#domestic> [62-4.160]
2. Upon completion of construction of the collection/transmission system project, and before placing the facilities into operation for any purpose other than testing for leaks or testing equipment operation, the permittee shall submit to the Department's Central District Office Form 62-604.300(8)(b), Request for Approval to Place a Domestic Wastewater Collection/Transmission System into Operation. This form is available at the Department's Internet site at:
<http://www.dep.state.fl.us/water/wastewater/forms.htm> [62-604.700(2), 11-6-03]
3. The new or modified collection/transmission facilities shall not be placed into service until the Department clears the project for use. [62-604.700(3), 11-6-03]
4. Permit revisions shall only be made in accordance with Rule 62-4.050(4)(s), F.A.C. Request for revisions shall be made to the Department in writing and shall include the appropriate fee. Revisions not covered under Rule 62-4.050(4)(s), F.A.C., shall require a new permit. [62-604.600(8), 11-6-03]
5. Abnormal events shall be reported to the Department's Central District office in accordance with Rule 62-604.550, F.A.C. For unauthorized spills of wastewater in excess of 1000 gallons per incident, or where information indicates that public health or the environment may be endangered, oral reports shall be provided to the STATE WARNING POINT TOLL FREE NUMBER, (800) 320-0519, as soon as practical, but no later than 24 hours from the time the permittee or other designee becomes aware of the circumstances. Unauthorized releases or spills less than 1000 gallons per incident are to be reported orally to the Department's Central District office within 24 hours from the time the permittee, or other designee becomes aware of the circumstances. [62-604.550, 11-6-03]
6. The permittee shall be responsible for proper operation and maintenance of the pump station, including clean-up of spills resultant from pump station malfunction and providing temporary service power generating and pumping equipment for emergency situations. In the event of equipment breakdown, power outages, destruction by hazard of fire, wind or by other cause, the permittee shall notify the Department, within 24 hours when such abnormal events result in the disposal of inadequately treated waste in violation of DEP Rule 62-604.130(1), F.A.C. in accordance with DEP Rule 62-604.550, F.A.C.

Permittee:
ORANGE COUNTY UTILITIES DEPARTMENT

Permit Number: CS48-0316825-001
Expiration Date: March 11, 2018

Attention: James N Broome, P.E.
Chief Engineer

Executed in Orlando, Florida.

STATE OF FLORIDA DEPARTMENT
OF ENVIRONMENTAL PROTECTION

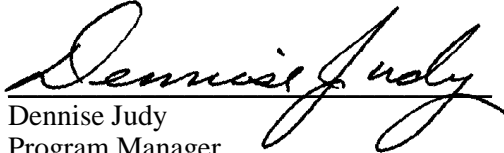

Dennise Judy
Program Manager
Domestic Waste Permitting

FILING AND ACKNOWLEDGEMENT

Filed, on this date, pursuant to Section 120.52, F.S., with the designated Department Clerk, receipt of which is hereby acknowledged.

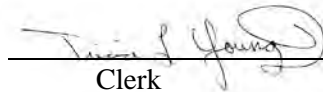

Clerk

March 13, 2013

Date

DJ/mcc/al/ply

Copies furnished to:
Heriberto Collado-Lopez (via email: heriberto.collado.ocfl.net)
Robert Murphy (via email: robert.murphy@ocfl.net)
Jeff Nazario (via email: Jeffrey.Nazario@ocfl.net)

CERTIFICATE OF SERVICE

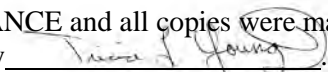
This is to certify that this NOTICE OF PERMIT ISSUANCE and all copies were mailed before the close of business on March 13, 2013 to the listed persons, by 



**FLORIDA DEPARTMENT OF
ENVIRONMENTAL PROTECTION**
CENTRAL DISTRICT
3319 MAGUIRE BOULEVARD, SUITE 232
ORLANDO, FLORIDA 32803

RICK SCOTT
GOVERNOR

CARLOS LOPEZ-CANTERA
LT. GOVERNOR

HERSCHEL T. VINYARD JR.
SECRETARY

PERMITTEE:
JAMES BROOME, CHIEF ENGINEER
ORANGE COUNTY UTILITIES
9150 CURRY FORD ROAD
ORLANDO, FL 32825
Jim.broome@ocfl.net

PERMIT NUMBER: 0327334-001
COUNTY: Orange
PROJECT: Rouse / University PS 3365
Rehabilitation
GENERATING: Zero GPD
CONNECTED TO: OCUD Eastern WRF
(FL0038849)

Dear Mr. Broome:

This letter acknowledges receipt of your Notification/Application for Constructing a Domestic Wastewater Collection/Transmission System for the subject project. Our office received the Notice on June 23, 2014.

This is to advise you that the Department does not object to your use of such General Permit.

Please note the attached requirements apply to your use of this General Permit for constructing the proposed domestic wastewater collection/transmission system. In accordance with Rule 62-4.540(13), F.A.C., this authorization shall be good for a period of five years from the date of this letter.

You are further advised that the construction activity must conform to the description contained in your Notification/Application for Constructing a Domestic Wastewater Collection/Transmission System and that any deviation will subject the permittee to enforcement action and possible penalties.

Sincerely,

Charles LeGros
Engineer
Wastewater Permitting

Date: July 2, 2014

CRL/ohm

cc: Geoff Hennessey, PE, Barnes Ferland and Assoc (via email: gennessey@bfaenvironmental.com)
Willard Hoanshelt, PE, EMI Consulting Specialties, Inc (via email: whoanshelt@emicfl.com)

REQUIREMENTS FOR USE OF THE GENERAL PERMIT FOR DOMESTIC WASTEWATER COLLECTION/TRANSMISSION SYSTEMS:

1. This general permit is subject to the general permit conditions of Rule 62-4.050, F.A.C., as applicable. This rule is available at the Department's Internet site at: <http://www.dep.state.fl.us/water/wastewater/rules.htm#domestic> [62-4.050]
2. This general permit does not relieve the permittee of the responsibility for obtaining a dredge and fill permit where it is required. [62-604.600(6)(b)1, 11-6-03]
3. This general permit cannot be revised, except to transfer the permit. [62-604.600(6)(b)2, 11-6-03]
4. Upon completion of construction of the collection/transmission system project, and before placing the facilities into operation for any purpose other than testing for leaks or testing equipment operation, the permittee shall submit to the Department's Central District Office, Form 62-604.300(8)(b), Request for Approval to Place a Domestic Wastewater Collection/Transmission System into Operation. This form is available at the Department's Internet site at: <http://www.dep.state.fl.us/water/wastewater/forms.htm> [62-604.700(2), 11-6-03]
5. The new or modified collection/transmission facilities shall not be placed into service until the Department clears the project for use. [62-604.700(3), 11-6-03]
6. Abnormal events shall be reported to the Department's Central District Office in accordance with Rule 62-604.550, F.A.C. For unauthorized spills of wastewater in excess of 1000 gallons per incident, or where information indicates that public health or the environment may be endangered, oral reports shall be provided to the STATE WARNING POINT TOLL FREE NUMBER (800) 320-0519 as soon as practical, but no later than 24 hours from the time the permittee or other designee becomes aware of the circumstances. Unauthorized releases or spills less than 1000 gallons per incident are to be reported orally to the Department's Central District Office within 24 hours from the time the permittee, or other designee becomes aware of the circumstances. [62-604.550, 11-6-03]

APPENDIX D

ORANGE COUNTY UTILITIES Standards and Construction Specification Manual

LIST OF APPROVED PRODUCTS

APPENDIX D

LIST OF APPROVED PRODUCTS - TRANSMISSION SYSTEMS

FEBRUARY 11, 2011

Cat.	Desc	Manufacturer	Water		Reclaimed Water		Wastewater	
			Model #	Comments	Model #	Comments	Model #	Comments
Air Release	ARV Enclosure	All ARV above ground enclosures shall be vented with tamper proof locking device						
		Water Plus Polyethylene Enclosure	131632 H30-B	Blue 44" Tall	131632 H30-P	Pantone 44"	131632 H30-G	Green 44" Tall
			171730 H40-B	Blue 30" Tall	171730 H40-P	Pantone 30"	171730 H40-G	Green 30" Tall
		Hot Box Vent Guard Fiberglass Enclosure	AVG2036 Encl	Blue 36" Tall	AVG2036 Encl	Pantone 36" Tall	AVG2036 Encl	Green 36" Tall
			GP3232 Base		GP3232 Base		GP3232 Base	
			AVG2041 Encl	Blue 41" Tall	AVG2041 Encl	Pantone 41" Tall	AVG2041 Encl	Green 41" Tall
		GP3232 Base		GP3232 Base		GP3232 Base		
	Safety-Guard/Hydro Guard	15100 Encl	Blue 34" Tall	15100 Encl	Pantone 34" Tall	15100 Encl	Green 34" Tall	
	Air Release Valves	Air Release Valves shall be Combination Type, 316 SS						
		ARI	D-040SS	Combination	D-040SS	Combination	D-020 (SS)	Combination
H-TEC		NA	NA	NA	NA	986 (316SS)	Combination	
Vent-O-Mat		Series RBX DN50	2"	Series RBX DN50	2"	RGX series		
ARV Vault	Air Release Valve Frame and Cover							
	US Foundry	NA	NA	NA	NA	USF 7665-HH-HJ		
Blow Off	Auto Blow Off	Automatic Blow Off Valve						
		Hydro Guard	HG-1 Standard Unit	Automatic	NA	NA	NA	NA
	Blow Off Valve	Blow Off Valve - Fits standard 5-1/4 inch Valve Box						
		Kupferle Foundry Co	Truflo Series TF #550		Truflo Series TF #550		NA	NA
	Water Plus Corp	The Hydrant Plus Series VB 2000B		The Hydrant Plus Series VB 2000B		NA	NA	
Casing Seals / Spacers	Casing End Seals	Casing End Seals. Annular space between pipe and steel casing shall be brick and mortar with end seals to secure ends.						
		Advance Products	Model AC and AW		Model AC and AW		Model AC and AW	
		BWM Company	Model WR and PO		Model WR and PO		Model WR and PO	
		Cascade Water Works	Model CCES		Model CCES		Model CCES	
		CCI Pipeline	Model ESW and ESC		Model ESW and ESC		Model ESW and ESC	
		Pipeline Seal & Insulator, Inc (PSI)	Model C and W		Model C and W		Model C and W	
		Power Seal	Model 4810ES		Model 4810ES		Model 4810ES	

Cat.	Desc	Manufacturer	Water		Reclaimed Water		Wastewater	
			Model #	Comments	Model #	Comments	Model #	Comments
Casing Seals / Spacers	Casing spacer	Casing spacers shall be a min. 8-inches wide for pipe 12" Dia or less or min. 12-inches wide for pipe 16 or greater , shall have a minimum 14 gauge 304 stainless steel shell/band, minimum 10 gauge 304 reinforced risers; minimum thickness of 0.090 EPDM or PVC interior liners, glass reinforces polymer or ultra high molecular weight polyethylene and 304 stainless bolts, nuts and washers.						
		Advance Products	SSI8 / SSI12		SSI8 / SSI12		SSI8 / SSI12	
		BWM Company	BWM-SS-8 / SS-12		BWM-SS-8 / SS-12		BWM-SS-8 / SS-12	
		Cascade Water Works	Series CCS 8" / 12"		Series CCS 8" / 12"		Series CCS 8" / 12"	
		CCI Pipeline	Model CCS8 / CSS12		Model CCS8 / CSS12		Model CCS8 / CSS12	
		Pipeline Seal & Insulator, Inc (PSI)	Series S8G-2 / S12G-2		Series S8G-2 / S12G-2		Series S8G-2 / S12G-2	
Coatings	Exterior Coatings for Exposed Metal Assets	Coatings: Aerial pipe, hydrants, above ground piping, fittings, valves and Appurtenances - System 1 Zinc / Urethane / Fluoropolymer application and color code per Section 3119 Coatings & Linings. Coating shall not be in contact with Potable water unless NSF 61 approved.						
		Carboline	Carbozinc 621	3.0 - 8.0 mils	Carbozinc 621	3.0 - 8.0 mils	Carbozinc 621	3.0 - 8.0 mils
			Carbothane 133 HB	3.0 -5.0 mils	Carbothane 133 HB	3.0 -5.0 mils	Carbothane 133 HB	3.0 -5.0 mils
			Carboxane 950	2.0 - 3.0 mils	Carboxane 950	2.0 - 3.0 mils	Carboxane 950	2.0 - 3.0 mils
		Tnemec	Zinc Series 90-97	2.5 - 3.5 mils	Zinc Series 90-97	2.5 - 3.5 mils	Zinc Series 90-97	2.5 - 3.5 mils
			Typoxy Series 27WB	4.0 -14.0 mils	Typoxy Series 27WB	4.0 -14.0 mils	Typoxy Series 27WB	4.0 -14.0 mils
			EnduraShield Series73	2.0 - 3.0 mils	EnduraShield Series73	2.0 - 3.0 mils	EnduraShield Series73	2.0 - 3.0 mils
	Hydroflon Series 700		2.0 - 3.0 mils	Hydroflon Series 700	2.0 - 3.0 mils	Hydroflon Series 700	2.0 - 3.0 mils	
	Exterior Coatings for Exposed Metal Assets	Coatings: Aerial pipe, hydrants, above ground piping, fittings, valves and Appurtenances - System 2 Zinc / Epoxy / Urethane application and color code per Section 3119 Coatings & Linings. Coating shall not be in contact with Potable water unless NSF 61 approved.						
		Carboline	Carbozinc 621	3.0 - 8.0 mils	Carbozinc 621	3.0 - 8.0 mils	Carbozinc 621	3.0 - 8.0 mils
			Carboguard 60	4.0 -6.0 mils	Carboguard 60	4.0 -6.0 mils	Carboguard 60	4.0 -6.0 mils
			Carboxane 950	2.0 - 3.0 mils	Carboxane 950	2.0 - 3.0 mils	Carboxane 950	2.0 - 3.0 mils
		Tnemec	Zinc Series 90-97	2.5 - 3.5 mils	Zinc Series 90-97	2.5 - 3.5 mils	Zinc Series 90-97	2.5 - 3.5 mils
			Typoxy Series 27WB	4.0 -14.0 mils	Typoxy Series 27WB	4.0 -14.0 mils	Typoxy Series 27WB	4.0 -14.0 mils
Hi-Build Epoxoline II			4.0 - 10.0 mils	Hi-Build Epoxoline II	4.0 - 10.0 mils	Hi-Build Epoxoline II	4.0 - 10.0 mils	
Series N69			Series N69		Series N69			
PPG / Ameron	EnduraShield Series73	2.0 - 3.0 mils	EnduraShield Series73	2.0 - 3.0 mils	EnduraShield Series73	2.0 - 3.0 mils		
	Amercoat 68HS	Min 3.0 mils	Amercoat 68HS	Min 3.0 mils	Amercoat 68HS	Min 3.0 mils		
	Amercoat 385	4.0 - 6.0 mils	Amercoat 385	4.0 - 6.0 mils	Amercoat 385	4.0 - 6.0 mils		
	Amercoat 450H	2.0 - 3.0 mils	Amercoat 450H	2.0 - 3.0 mils	Amercoat 450H	2.0 - 3.0 mils		

APPENDIX D

LIST OF APPROVED PRODUCTS - TRANSMISSION SYSTEMS

FEBRUARY 11, 2011

Cat.	Desc	Manufacturer	Water		Reclaimed Water		Wastewater	
			Model #	Comments	Model #	Comments	Model #	Comments
Fittings	Fittings	Ductile Iron Fittings C153 SSB / C110 FLG: (Water & Reclaimed Water fittings shall cement lined or holiday free fusion bonded epoxy lined) (Wastewater fittings interior shall be Protecto 401 and holiday free)						
		American	30" & up	FBE / Cement	30" & up	FBE / Cement	30" & up	Protecto 401
		Sigma		FBE / Cement		FBE / Cement		Protecto 401
		Star		FBE / Cement		FBE / Cement		Protecto 401
		Tyler Union & Clow		FBE / Cement		FBE / Cement		Protecto 401
Flow Meter	Flow Meter	Flow Meters With Replaceable Sensors						
		EMCO	NA	NA	NA	NA	Unimag 4411E	
Hydrants	Hydrants	Hydrants Shall open left, 1-1/2 Pentagon operating nut, NST hose & pumper thread, rotate 360 degrees, closed drains, epoxy on shoe in & out and 304 SS nuts & bolts below ground.						
		American Flow Control	B-84-B (6 inch)		NA	NA	NA	NA
		Clow	Medallion 2545		NA	NA	NA	NA
		Mueller	Super Centurion 250		NA	NA	NA	NA
Joint Restraints	Ductile iron pipe MJ Restraints	Mechanical Joint Wedge-action Restraining Gland, Epoxy Coated Restrain ductile iron pipe to mechanical joint fittings, pipe and appurtenances.						
		EBAA Iron Inc	Megalug Series 1100		Megalug Series 1100		Megalug Series 1100	
		Ford / Uni-Flange	UFR-1400		UFR-1400		UFR-1400	
		Sigma	OneLok Series SLD/SLDE		OneLok Series SLD/SLDE		OneLok Series SLD/SLDE	
		Smith Blair	Cam Lok Series 111		Cam Lok Series 111		Cam Lok Series 111	
		Star	Star Grip Series 3000		Star Grip Series 3000		Star Grip Series 3000	
		Tyler Union	TufGrip Series TLD		TufGrip Series TLD		TufGrip Series TLD	
	DIP Bell Joint Restraints (4" - 12") (New & Existing)	Bell Joint Restraints for Ductile Iron Pipe (4"-12") (New & Existing) - All restraints split serrated on bell and spigot ends. Pipe 16" and greater shall have restraint gaskets or locking bells. (Wastewater only for restraint of existing DIP FM)						
		EBAA Iron Inc	Tru-Dual Series 1500TD		Tru-Dual Series 1500TD		Tru-Dual Series 1500TD	
		Ford / Uni-Flange	Uni-Flange Series 1390C		Uni-Flange Series 1390C		Uni-Flange Series 1390C	
		Sigma	PV-Lok Series PWP-C		PV-Lok Series PWP-C		PV-Lok Series PWP-C	
		Smith Blair	Bell-Lock Series 165		Bell-Lock Series 165		Bell-Lock Series 165	
		Star	StarGrip Series 3100S		StarGrip Series 3100S		StarGrip Series 3100S	
DIP Bell Joint Restraints (16" & Greater)	Ductile Iron Pipe Bell Joint Restraints for Ductile Iron Pipe (16" & Greater) - All restraints shall have a split back-up ring for the bell and a serrated or wedge action gland for the spigot end. New installation for water & reclaimed water piping 16" and greater shall have restraint gaskets or locking bells.							
	EBAA Iron Inc	Series 1100HD	Existing Only	Series 1100HD	Existing Only	Series 1100HD	Existing Only	
	Sigma	Series SSLDH	Existing Only	Series SSLDH	Existing Only	Series SSLDH	Existing Only	
	Star	Series 3100S	Existing Only	Series 3100S	Existing Only	Series 3100S	Existing Only	

APPENDIX D

LIST OF APPROVED PRODUCTS - TRANSMISSION SYSTEMS

FEBRUARY 11, 2011

Cat.	Desc	Manufacturer	Water		Reclaimed Water		Wastewater	
			Model #	Comments	Model #	Comments	Model #	Comments
Joint Restraints	Ductile iron pipe Bell Joint Restraint Gaskets and Locking Bell (4" & Above)	Bell Joint Restraint Gaskets and Locking Bell (4" & Above) Stainless Steel locking wedges built into the gasket-rubber. ANSI/AWWA C111/A21.11 Standard for Rubber-Gasket Joints for Ductile Iron Pressure Pipe. Ductile Iron Bell Joint Restraint for Push-On Pipe- Locking bell joint system that prevents joint separation and allows for joint deflection. Bells shall be painted red to verify restrained gasket.						
		American	Fast Grip Gasket	Gasket	Fast Grip Gasket	Gasket	NA	NA
			Flex-Ring Joint	Bell Lock	Flex-Ring Joint	Bell Lock	NA	NA
			Lok-Ring Joint	Bell Lock	Lok-Ring Joint	Bell Lock	NA	NA
		Griffin	Talon RJ Gasket	Gasket	Talon RJ Gasket	Gasket	NA	NA
			Snap-Lok	Bell Lock	Snap-Lok	Bell Lock	NA	NA
			McWane Inc. DI Pipe Group	Sure Stop 350 Gasket	Gasket	Sure Stop 350 Gasket	Gasket	NA
		Thrust-Lock		Bell Lock	Thrust-Lock	Bell Lock	NA	NA
		TR-Flex		Bell Lock	TR-Flex	Bell Lock	NA	NA
		Super-Lock		Bell Lock	Super-Lock	Bell Lock	NA	NA
		US Pipe	Field Lok 350 Gasket	Gasket	Field Lok 350 Gasket	Gasket	NA	NA
			Field Lok Gasket	Gasket	Field Lok Gasket	Gasket	NA	NA
			TR-Flex	Bell Lock	TR-Flex	Bell Lock	NA	NA
			HP Lok Restraint Joint	Bell Lock	HP Lok Restraint Joint	Bell Lock	NA	NA
	SS to DIP Transition Restraint	SS to DIP Transition Restraint -Flanged stainless steel pipe from Wetwell to Valve box restrained joint transition (epoxy coated, SS hardware) Flg x PE RJ.						
		EBAA Iron Inc	NA	NA	NA	NA	Megaflange 2100	
		Sigma	NA	NA	NA	NA	SigmaFlange with One Lock SLDE	
		Smith Blair	NA	NA	NA	NA	911 Flange - Lock Restrained FCA	
	PVC Pipe MJ Restraints	Mechanical Joint Wedge-action Restraining Gland, Epoxy Coated Restrain PVC pipe to mechanical joint fittings, and appurtenances.						
		EBAA Iron Inc	Mega-lug Series 2000PV		Mega-lug Series 2000PV		Mega-lug Series 2000PV	
			NA	NA	NA	NA	Megalug Series 2200 (42"-48")	
		Ford / Uni-Flange	UFR 1500 Series		UFR 1500 Series		UFR 1500 Series	
		Sigma	One Lok Series SLC/SLCE		One Lok Series SLC/SLCE		One Lok Series SLC/SLCE	
		Smith Blair	Cam Lok Series 120		Cam Lok Series 120		Cam Lok Series 120	
		Star	Star Grip Series 4000		Star Grip Series 4000		Star Grip Series 4000	
	Tyler Union	TufGrip Series TLP		TufGrip Series TLP		TufGrip Series TLP		
	PVC Bell Joint Restraints (4" - 12") (New & Existing)	PVC Bell Joint Restraints: PVC pipe Split Serrated on Bell End and Spigot End. (4" - 12") (New & Existing)						
		EBAA Iron Inc	Tru-Dual Series 1500TD		Tru-Dual Series 1500TD		Tru-Dual Series 1500TD	
Ford / Uni-Flange		Uni-Flange Series 1390		Uni-Flange Series 1390		Uni-Flange Series 1390		
Sigma		PV-Lok Series PWP		PV-Lok Series PWP		PV-Lok Series PWP		
Smith Blair		Bell-Lock Series 165		Bell-Lock Series 165		Bell-Lock Series 165		
Star		Series 1100C		Series 1100C		Series 1100C		
Tyler Union		TufGrip 300C		TufGrip 300C		TufGrip 300C		

APPENDIX D

LIST OF APPROVED PRODUCTS - TRANSMISSION SYSTEMS

FEBRUARY 11, 2011

Cat.	Desc	Manufacturer	Water		Reclaimed Water		Wastewater	
			Model #	Comments	Model #	Comments	Model #	Comments
Joint Restraints	PVC Bell Joint Restraints (16" & Greater)	PVC Bell Joint Restraints: (16" & Greater) PVC pipe Split Serrated on Bell End and Spigot End. Water & Reclaimed Water Existing pipe only. Wastewater shall be new and existing pipe.						
		Ford / Uni-Flange	Series 1390	Existing Only	Series 1390	Existing Only	Series 1390	
		JCM	Sur-Grip Series 621	Existing Only	Sur-Grip Series 621	Existing Only	Sur-Grip Series 621	
		Sigma	PV-Lok PWP	Existing Only	PV-Lok PWP	Existing Only	PV-Lok PWP	
		Smith Blair	Bell-Lock Series 165	Existing Only	Bell-Lock Series 165	Existing Only	Bell-Lock Series 165	
		Star	Series 1100C	Existing Only	Series 1100C	Existing Only	Series 1100C	
Pipe	PVC C900 DR 18 Bell & Spigot (4" - 12")	C900 Bell & Spigot PVC Pipe: 4 to 12-inch - AWWA C-900, Minimum DR18 for Water, Reclaimed and Wastewater. DR14 for Fire Lines. Manufacturers shall be members in good standing with Uni-Bell to maintain approval status.						
		Certaiteed 4" to 12"	Certa-Lok C900/RJ	Blue	Certa-Lok C900/RJ	Pantone Purple	Certa-Lok C900/RJ	Green
		Diamond Plastics Corp	C-900	Blue	C-900	Pantone Purple	Diamond C900	Green
		Ipex Inc	C-900 Blue Brute	Blue	C-900	Pantone Purple	C900 Blue Brute	Green
		JM Eagle	C-900	Blue	C-900	Pantone Purple	C-900	Green
		National Pipe & Plastics Inc	C-900 Dura- Blue	Blue	C-900	Pantone Purple	C-900 Pipe	Green
		North American Pipe Corp (NAPCO)	C-900	Blue	C-900	Pantone Purple	C-900	Green
		Sanderson Pipe Corp	C-900	Blue	C-900	Pantone Purple	C-900	Green
	PVC C905 DR 18 Bell & Spigot 16" and Larger	C905 Bell & Spigot PVC Pipe 16" and Larger: AWWA C-905, Minimum DR18 for all Force Mains up to 24". Minimum DR21/DR25 for 30" and greater. Manufacturers shall be members in good standing with Uni-Bell to maintain approval status.						
		Certaiteed 16"	NA	NA	NA	NA	Certa-Lok C905/RJ	NA
		Diamond Plastics Corp	NA	NA	NA	NA	Trans-21 DR18	Green
		Ipex Inc	NA	NA	NA	NA	IPEX Centurion	Green
		JM Eagle	NA	NA	NA	NA	C905 Big Blue	Green
National Pipe & Plastics Inc		NA	NA	NA	NA	C905	Green	
HDPE C906 DR11	HDPE Pipe DR11 AWWA C906 shall be Ductile Iron Pipe Size, PE 3408/3608/4710 DIPS manufactured in accordance with ASTM F-714 and listed with NSF. Pipe shall be marked in accordance with either AWWA C901,AWWA C906. Compression type connections are not acceptable in new installations. Pipe joints shall be butt fusion or electro-fusion with flange or adapter. All HDPE shall be color coded to the Utility. Color identifications are in accordance with the APWA/ULCC Uniform Color Code. Manufacturers shall be members in good standing with PPI to maintain approval status.							
	JM Eagle	HDPE	DR11 Blue	HDPE	DR11 Pantone	HDPE	DR11Green	
	Performance Pipe(Chevron)	Driscoplex 4000	DR11 Blue	Driscoplex 4000	DR11 Pantone	Driscoplex 4300	DR11 Green	
	PolyPipe, Inc.	EHMW Poly Pipe	DR11 Blue	EHMW	DR11 Pantone	EHMW	DR11Green	

APPENDIX D

LIST OF APPROVED PRODUCTS - TRANSMISSION SYSTEMS

FEBRUARY 11, 2011

Cat.	Desc	Manufacturer	Water		Reclaimed Water		Wastewater	
			Model #	Comments	Model #	Comments	Model #	Comments
Pipe	Ductile Iron Pipe	Ductile iron/Cast iron: (4" to 12" = Class 350, 16" to 24" - Class 250, 30" to 64" = Class 200). Water and Reclaimed water shall be cement lined. Wastewater Piping shall be Protecto 401 and Holiday Free. Exterior coatings as specified. Wastewater DIP piping shall be for pump station piping only. Manufacturers shall be members in good standing with DIPRA to maintain approval status.						
		American	Cement Lined	Blue	Cement Lined	Pantone Purple	Protecto 401	Pump Station
		Griffin	Cement Lined	Blue	Cement Lined	Pantone Purple	Protecto 401	Pump Station
		McWane Inc. DI Pipe Group	Cement Lined	Blue	Cement Lined	Pantone Purple	Protecto 401	Pump Station
		US Pipe	Cement Lined	Blue	Cement Lined	Pantone Purple	Protecto 401	Pump Station
Sample	Sample Station	Sample Stations - Bacteriological Sample Station with built in flush system, all internal piping to be 2", brass and includes lockable green enclosures.						
		Safety-Guard	SG-BSS-05 pedestal #77	green enclosure	NA	NA	NA	NA
		Water Plus Corp	Model 5000	green	NA	NA	NA	NA
Services	Brass Service Saddles	Brass Service Saddles for 1" & 2" water & reclaimed water services on 4" through 12" Mains - Service saddles can be hinge or bolt controlled OD saddles to be used on C-900 and existing IPS OD PVC pipe.						
		Ford	Series S-70, S-90	4"-12"	Series S-70, S-90	4"-12"	NA	NA
		AY McDonald	Model 3891 / 3895,3801 / 3805	4"-12"	Model 3891 / 3895,3801 / 3805	4"-12"	NA	NA
		Mueller	Series S-13000/H-13000	4"-12"	Series S-13000/H-13000	4"-12"	NA	NA
	Services	Service Saddles	Service Saddles for 1" (CC) & 2" (Iron pipe threads) Water & Reclaimed Water services on mains greater than 12". Service saddles for 2" taps (iron pipe threads) on 4" mains and greater for Waste Water. : Epoxy or nylon coated stainless steel 18-8-type 304 double straps, controlled O.D. saddles to be used on C-900 / C905 or DI for all 1-in and -2in taps on pipes over 12in.					
Ford			Series FC202	16" & greater	Series FC202	16" & greater	Series FC202	4" & greater
JCM			Series 406	16" & greater	Series 406	16" & greater	Series 406	4" & greater
Mueller			DR2S	16" & greater	DR2S	16" & greater	DR2S	4" & greater
Romac			Series 202NS	16" & greater	Series 202NS	16" & greater	Series 202NS	4" & greater
Smith Blair			Series 317	16" & greater	Series 317	16" & greater	Series 317	4" & greater
Services	Service Saddles for HDPE	Service Saddles for 1" (CC) & 2" (Iron Pipe threads) Water and Reclaimed Water Services: Epoxy or nylon coated stainless steel 18-8-type 304 double straps, controlled O.D. saddles to be used on HDPE for all 1-in and -2in taps. Taps to HDPE pipe shall be approved on a case by case basis.						
		Ford	Series FCP202		Series FCP202		Series FCP202	
		Romac	Series 202N-H		Series 202N-H		Series 202N-H	
		Smith Blair	Series 317-1 for HDPE		Series 317-1 for HDPE		Series 317-1 for HDPE	
Corporation	Stops Ball Type	Corporation Stops Ball Type (1-inch with AWWA taper C threads only/pack joint outlet for CTS) 2" Corporation Stop Ball Type shall be 2" MIP X FIP threads.						
		Ford	FB1000, FB1700-7		FB1000, FB1700-7		FB1700-7	2" ARV
		AY McDonald	4701B-22, 3149B2		4701B-22, 3149B2		3149B2	2" ARV
		Mueller	P25008, B-20046		P25008, B-20046		B-20046	2" ARV

Cat.	Desc	Manufacturer	Water		Reclaimed Water		Wastewater	
			Model #	Comments	Model #	Comments	Model #	Comments
Services	Curb Stops	Curb Stops - Straight Valves: Ball type compression 2" cts O.D. tubing by 2" FIP						
		Ford	B41-777W		B41-777W		NA	NA
		AY McDonald	6102W-22		6102W-22		NA	NA
		Mueller	P25172		P25172		NA	NA
	Curb Stops	Curb Stops - Straight Valves: ball type compression x compression						
		Ford	B44-444W		B44-444W		NA	NA
		AY McDonald	6100W-22		6100W-22		NA	NA
		Mueller	P25146		P25146		NA	NA
	PE tubing	Polyethylene tubing: AWWA C901. UV protection (SDR-9) 1-inch and 2-inch only. PE 3408 / PE 4710						
		Charter Plastics	Blue Ice		Lav Ice		NA	NA
		Endot	Endopure Blue		Endocore Lavender		NA	NA
		JM Eagle	Pure-Core		NA	NA	NA	NA
Line Stops	Line Stops							
	JCM							
	Romac							
	Smith Blair							
Tapping Sleeves and Valves	Tapping Sleeves	Tapping Sleeves: (Mechanical joint for taps on cast iron, ductile iron, PVC & AC pipe, including size on size) with stainless steel nuts and bolts.						
		American Flow Control	Series 2800		Series 2800		Series 2800	
			Series 1004		Series 1004		Series 1004	
		Clow	Series F-5205	DIP/PVC	Series F-5205	DIP/PVC	Series F-5205	DIP/PVC
			Series F-5207	A/C Pipe	Series F-5207	A/C Pipe	Series F-5207	A/C Pipe
		JCM	Series 414	FBE	Series 414	FBE	Series 414	FBE
		Mueller	Series H-615	DIP/PVC	Series H-615	DIP/PVC	Series H-615	DIP/PVC
			Series H-619	A/C Pipe	Series H-619	A/C Pipe	Series H-619	A/C Pipe
Smith Blair	Style 623	FBE	Style 623	FBE	Style 623	FBE		
Tapping Valves: 12" and smaller	Tapping Valves: 12" and smaller - Tapping Valves shall be furnished with an alignment lip and installed in the vertical position for Water and Reclaim Water. Wastewater shall be installed horizontally and abandoned in the open position. Tapping valves shall be resilient seated only and meet the requirements of AWWA C509 or C515							
	American Flow Control	Series 2500	Alignment Lip	Series 2500	Alignment Lip	Series 2500	Alignment Lip	
	Clow	Series F-6114	Alignment Lip	Series F-6114	Alignment Lip	Series F-6114	Alignment Lip	
	Mueller	Series T2360 (4"-12")	Alignment Lip	Series T2360 (4"-12")	Alignment Lip	Series T2360 (4"-12")	Alignment Lip	

APPENDIX D

LIST OF APPROVED PRODUCTS - TRANSMISSION SYSTEMS

FEBRUARY 11, 2011

Cat.	Desc	Manufacturer	Water		Reclaimed Water		Wastewater	
			Model #	Comments	Model #	Comments	Model #	Comments
Tapping Sleeves and Valves	Tapping Valves: 16" and Larger	Tapping Valves: 16" and Larger - Tapping valves shall be furnished with an alignment lip and be installed in the vertical position for Water and Reclaimed Water. No tapping valve shall be installed horizontally for Water and Reclaim Water unless approved by the engineer. Tapping Valves 16" and larger AWWA C515 resilient seated only (16" and 24" no gearing required) above 24" shall be installed vertically with a spur gear actuator unless noted by the engineer. All tapping valves above 24" shall be furnished with NPT pipe plugs for flushing the tracks when valves are installed horizontally. Tapping valves for Wastewater shall be installed horizontally and abandoned in open position.						
		American Flow Control	Series 2500	Alignment Lip & flushing port	Series 2500	Alignment Lip & flushing port	Series 2500	Alignment Lip & flushing port
		Clow	Series F-6114	Alignment Lip & flushing port	Series F-6114	Alignment Lip & flushing port	Series F-6114	Alignment Lip & flushing port
		Mueller	Series T2361 (14"&up)	Alignment Lip & flushing port	Series T2361 (14"&up)	Alignment Lip & flushing port	Series T2361 (14"&up)	Alignment Lip & flushing port
Valves	Butterfly Valve 42" and Above	Butterfly Valves 42"and above. AWWA C504. Actuators input torques based on 150 psi valve pressure and 16 fps velocity with a maximum input of 80 ft-lb on 2" nuts and shall withstand 250 ft-lbs. Valve seats shall be leak-tight in both directions at 150 psi.						
		Clow	Style #1450		Style #1450		NA	NA
		Dezurik	BAW		BAW		NA	NA
		Mueller / Pratt	LINSEAL III / Groundhog		LINSEAL III / Groundhog		NA	NA
	Check Valves	Valves (Check) 4-inch and Larger (8 mil epoxy lined)						
American Flow Control		NA		NA		Series 600 or 50 line		
Clow / M&H / Kennedy		NA		NA		106		
Gate Valves 4" - 12"	Gate Valves 12" and smaller - resilient seated only AWWA C509 or C515. Valve seat shall be leak-tight in both directions at 150 psi.							
	American Flow Control	Series 2500		Series 2500		NA	NA	
	Clow	Series F-6100		Series F-6100		NA	NA	
	Mueller	Series A-2360		Series A-2360		NA	NA	
Gate Valves (Vertical) 16" and Up	Gate Valves 16" and larger (Vertical Installation) AWWA C515 resilient seated only (16" and 24" no gearing required) above 24" shall be installed vertically with a gear actuator unless noted by the engineer. Valve seat shall be leak-tight in both directions at 150 psi.							
	American Flow Control	Series 2500		Series 2500		NA	NA	
	Clow	Series F-6100		Series F-6100				
	Mueller	Series A-2361		Series A-2361		NA	NA	

Cat.	Desc	Manufacturer	Water		Reclaimed Water		Wastewater			
			Model #	Comments	Model #	Comments	Model #	Comments		
Valves	Plug Valves	Plug Valves - Bi-directional, MJ & Flanged (min. 8mil fusion bonded epoxy with stainless steel bolts), gear operator to be sized for rated pressure of the valve. Valves 4"-20" shall be 80% Full Port and valves 24" and greater shall be minimum of 70% full port. Valve shall be factory tested to minimum 100 PSI in both directions.								
		Clow	NA	NA	NA	NA	F-5412 FLG	4" & up		
			NA	NA	NA	NA	F-5413 MJ	4" & up		
		Dezurik	NA	NA	NA	NA	Series PEF or PEC	4" & up		
		Millikan / Pratt	NA	NA	NA	NA	Eccentric / Ballcentric	4" & up		
			NA	NA	NA	NA	5600 or 5800 (FLG)	4" & up		
Val-Matic	NA	NA	NA	NA	5700 or 5900 (MJ)	4" & up				
Valve Boxes	Valve Boxes with Locking Lids (Cast Iron)	Two piece standard screw type Heavy Duty Valve Boxes with Locking Lids (Cast Iron) and type of service cast in heavy duty traffic lid (H2O loading) ASTM A48								
		Bingham/Taylor	Series 4905	Box	NA	NA	Series 4905	Box		
			4905-X	Extension	NA	NA	4905-X	Extension		
			4904-L	Blue Water Locking Lid	NA	NA	4904-L	Green Sewer locking Lid		
		Sigma	Series VB 261X-267X	Box	VB-25031LK-VB-2612	Box	Series VB 261X-267X	Box		
			VB 6302	Extension	VB-6302	Extension	VB 6302	Extension		
			VB 4650W	Blue Water Locking Lid	VB2503LK	Purple Square Locking Lid	VB 4650S	Green Sewer locking Lid		
		Star	Series VB-0002	Box	NA	NA	Series VB-0002	Box		
			VBEX 12-24S	Extension	NA	NA	VBEX 12-24S	Extension		
			VBLIDLOCK	Blue Water Locking Lid	NA	NA	VBLIDLOCK	Green Sewer locking Lid		
		Tyler Union	Series 6850	Box	NA	NA	Series 6850	Box		
			58, 59, 60	Extension	NA	NA	58, 59, 60	Extension		
			Locking Lid	Blue Water Locking Lid	NA	NA	Locking Lid	Green Sewer locking Lid		
		Valve Box	Valve Box	For mains equal to, or greater than, 16" diameter or equal to greater than 6' feet deep						
				American Flow Control	# 2A - 9A Retrofit Valve Box Insert	Fit inside std valve boxes	NA		2A - 9A Retrofit Valve Box Insert	Green Sewer locking Lid
Mueller Company	MVB050C thru MVB130C with Extension Stem			Blue Water Locking Lid	MVB050CR thru MVB130CR with Extension Stem	Purple Square Locking Reclaim Lid	MVB050C thru MVB130C with Extension Stem	Green Sewer locking Lid		
		MVB875 Guide Plate		MVB875 Guide Plate		MVB875 Guide Plate				

APPENDIX D

LIST OF APPROVED PRODUCTS - GRAVITY SYSTEMS

FEBRUARY 11, 2011

Cat.	Desc	Manufacturer	Water		Reclaimed Water		Wastewater	
			Model #	Comments	Model #	Comments	Model #	Comments
Coatings	Anti-Graffiti Paint	Block Walls-Anti-Graffiti Paint per Section 3119 Coatings & Linings						
		American Building Restoration Products	NA	NA	NA	NA	Polyshield Graffiti Preventer for Unpainted Masonry Type B	Super Bio Strip or Strip it all
		Tnemec / Chemprobe	NA	NA	NA	NA	626 DUR A PEL	680 Mark A Way
		Professional Products of Kansas, Inc	NA	NA	NA	NA	Professional Water Seal & Anti-Graffitiant (PWS-15 Super Strength)	Professional Phase II Cleaner
	Coatings for Existing Manholes	Rehabilitation corrosion protection system per Section 3119 Coatings & Linings. Interior coating for force main connections to existing concrete manholes only. New precast structures and existing pump stations shall be lined.						
		CCI Spectrum, Inc	NA	NA	NA	NA	Spectrashield	min of 500 mils
		Kerneos Aluminate Technologies	NA	NA	NA	NA	Sewpercoat	1" (1000mil)
		Raven Lining System	NA	NA	NA	NA	Raven 155 Primer Raven 405	min 8 mils min 125 mils
		Sauereisen	NA	NA	NA	NA	210 Series Topcoat Glaze 210G	min 125 mils min 20 mils
		Tnemec	NA	NA	NA	NA	Series 434 Topcoat Glaze 435	min 125 mils 15-20 mils
PVC Pipe and fittings	Pipe SDR 35 Gravity Mains	PVC Pipe for Gravity SDR26/SDR 35 (Green in color) ASTM-D034. Manufacturers shall be members in good standing with Uni-Bell to maintain approval status.						
		Certainteed	NA	NA	NA	NA	Gravity Sewer Pipe	
		Diamond Plastics Corp	NA	NA	NA	NA	Sani-21 SDR-35	
		JM Eagle	NA	NA	NA	NA	Gravity Sewer	
		National Pipe & Plastics, Inc.	NA	NA	NA	NA	Ever-Green Sewer Pipe	
		North American Pipe Corp (NAPCO)	NA	NA	NA	NA	Gravity Sewer	
		Sanderson Pipe Corp	NA	NA	NA	NA	Gravity Sewer	
	Locate Balls	Locating Marker Systems - Wastewater Locator balls placed at all sanitary sewer cleanouts						
		3M	NA	NA	NA	NA	3M™ EMS 4" Extended Range 5' Ball Marker 1404-XR	
	Fittings SDR 35	Fittings, Adapters and Plugs - Gravity PVC ASTM-D3034, Min SDR26/ SDR 35						
		GPK Products, Inc.	NA	NA	NA	NA	SDR26/SDR35 Gasketed sewer fittings	
		Harrington Corporation (HARCO)	NA	NA	NA	NA	SDR26/SDR35 Gasketed sewer fittings	
		Multi Fittings Corp.	NA	NA	NA	NA	SDR26/SDR 35 Trench Tough Sewer Fittings	
JM Eagle		NA	NA	NA	NA	SDR26/SDR35 Gasketed sewer fittings		
Plastic Trends Inc		NA	NA	NA	NA	SDR26/SDR35 Gasketed sewer fittings		
TIGRE USA, Inc.		NA	NA	NA	NA	SDR26/SDR35 Gasketed sewer fittings		

APPENDIX D

LIST OF APPROVED PRODUCTS - GRAVITY SYSTEMS

FEBRUARY 11, 2011

Cat.	Desc	Manufacturer	Water		Reclaimed Water		Wastewater		
			Model #	Comments	Model #	Comments	Model #	Comments	
PVC Pipe a	Flexible Pipe Connectors	Flexible Pipe Connectors and Transitions							
		Fernco	NA	NA	NA	NA	1002, 1051, 1056 Series		
		Indiana Seal	NA	NA	NA	NA	102, 151, 156 Series		
		Mission Rubber	NA	NA	NA	NA	MR02, MR51, MR 56 Series		
Precast Concrete Structures	MH Lids	Frame and Cover							
		USF Fabrication Inc.	NA	NA	NA	NA	USF 225-AS		
	Adj Ring	Top Adjusting Rings - HDPE with heavy duty loading (H-20)							
		Ladtech, Inc	NA	NA	NA	NA	24R, 24S with Rope Sealant CS2455		
	Hatches	Wet Well and Valve Vault Access Frames and Covers (Include the term "Confined Space" etched or cast into the cover with recessed lock & hasp. Frames and covers per manufacturers specifications.							
		Halliday Products	NA	NA	NA	NA	S1R or S2R Series		
		USF Fabrication Inc.	NA	NA	NA	NA	APS or APD Series		
	Precast Concrete Structures	Precast Manhole and Wetwell Structures ASTM C478. Precast concrete shall be batched with concrete dyed crystalline waterproofing admixture with corrosion protection. Concrete without admixture or without color tint /tracer shall be rejected.							
		Allied Precast	NA	NA	NA	NA		Dyed Admix	
		Atlantic Concrete Products, Inc.	NA	NA	NA	NA		Dyed Admix	
		Delzotto Products, Inc.	NA	NA	NA	NA		Dyed Admix	
		Dura Stress Underground Inc.	NA	NA	NA	NA		Dyed Admix	
		Hanson Pipe & Product	NA	NA	NA	NA		Dyed Admix	
		Mack Concrete	NA	NA	NA	NA		Dyed Admix	
		Oldcastle Precast	NA	NA	NA	NA		Dyed Admix	
Standard Precast Inc.	NA	NA	NA	NA		Dyed Admix			
Concrete Admix	Crystalline Waterproofing Concrete Admix with color dye shall be added to all concrete structures (precast and cast-in-place) to provide waterproofing and corrosion resistance. Concrete without admixture or without color tint / tracer shall be rejected. % concentration of admix with colored dye added to the mix shall be based on weight of cement.								
	Kryton International	NA	NA	NA	NA	KIM K-301R (with red dye)	2%		
	Xypex Chemical Corp	NA	NA	NA	NA	Xypex Admix C-1000Red (with red dye)	3.0 - 3.5%		
Liners	Interior Liner for New or existing Precast Manhole and Precast Wetwell Structures per Section 3119 Coatings & Linings								
	AFE	NA	NA	NA	NA	Fiberglass Liner			
	AGRU Liner	NA	NA	NA	NA	HDPE Liner (Min 2 mm for Manhole / Min 5 mm for Pump Station)			
	Containment Solutions Inc. (Flowtite)	NA	NA	NA	NA	Fiberglass Liner			
	GSE Studliner	NA	NA	NA	NA	HDPE Liner (Min 2 mm for Manhole / Min 5 mm for Pump Station)			
	GU Liner	NA	NA	NA	NA	Reinforced Plastic Liner			
		L & F Manufacturing	NA	NA	NA	NA	Fiberglass Liner		

APPENDIX D

LIST OF APPROVED PRODUCTS - GRAVITY SYSTEMS

FEBRUARY 11, 2011

Cat.	Desc	Manufacturer	Water		Reclaimed Water		Wastewater		
			Model #	Comments	Model #	Comments	Model #	Comments	
Precast Concrete Structures	Heat Shrink Seal	Heat Shrink Seal - Precast structures shall be primed with manufacturer approved primer prior to application of heat shrunk encapsulation.							
		Canusa-CPS	NA	NA	NA	NA	Wrapid Seal with WrapidSeal Primer (Canusa G Primer)		
		Pipeline Seal & Insulator, Inc (PSI)	NA	NA	NA	NA	Riser Wrap with Polyken 1027 or 1039 primer		
	Joining Material	Joining Material Min. 2" width for all products to ensure squeeze out with manufacturer approved primer.							
		Henry Company	NA	NA	NA	NA	Ram-Nek	with Primer	
		Martin Asphalt Company	NA	NA	NA	NA	Evergrip 990	with Primer	
		Trelleborg Pipe Seals	NA	NA	NA	NA	NPC – Bidco C-56	with Primer	
	Pipe Seals Gravity	Resilient Connector Pipe Seals, Manhole - Gravity less than 12-inch and less than 15-ft deep							
		Atlantic Concrete	NA	NA	NA	NA	A-Lok (cast-in-place)		
		Hail Mary Rubber	NA	NA	NA	NA	Star Seal (cast-in-place)		
		IPS	NA	NA	NA	NA	Wedge Style		
		NPC	NA	NA	NA	NA	Kor-N-Seal Model WS		
		Press seal gasket	NA	NA	NA	NA	PSX Direct Drive		
	Pipe Seals Gravity	Cast in Place Pipe Seals, Manhole - Gravity Greater Than or Equal to 12-inch and all pipe sizes greater than 15-ft deep							
		Atlantic Concrete	NA	NA	NA	NA	A-Lok	cast in place	
		Hail Mary Rubber	NA	NA	NA	NA	Star Seal	cast in place	
	FM Pipe Seals	Modular Pipe Seals for Wet Well and Valve Box penetrations and all forcemain connections to existing and new precast concrete structures. EPDM Rubber with 316 SS Hardware							
		CCI Pipeline Systems	NA	NA	NA	NA	Wrap-It Link WL-SS Series		
		Pipeline Seal & Insulator, Inc / Link Seal	NA	NA	NA	NA	Link-Seal S-316 Modular Seal		
		Proco Products, Inc	NA	NA	NA	NA	PenSeal ES-PS Series		

APPENDIX D

LIST OF APPROVED PRODUCTS - PUMP STATION SYSTEMS

FEBRUARY 11, 2011

Cat.	Desc	Manufacturer	Water		Reclaimed Water		Wastewater	
			Model #	Comments	Model #	Comments	Model #	Comments
Generator	Gen	Generator Systems, Fixed Shall be UL 2200 Certified.						
		Caterpillar	NA	NA	NA	NA	CAT Diesel Generator Set	
		Cummins Power Generation	NA	NA	NA	NA	Diesel Generator Set	
	Fuel Tanks	Generator Fuel Tanks. Shall be UL2085 certified.						
		Convault	NA	NA	NA	NA	CVT-3SF or CVT-3FF	
		Phoenix	NA	NA	NA	NA	Envirovault	
	GR	Generator Receptacle (GR)						
		Cooper Crouse-Hinds	NA	NA	NA	NA	AR2042 (230V, 200A, 3P, 4W) With AJA1 Angle Adaptor	
		Cooper Crouse-Hinds	NA	NA	NA	NA	AR2042-S22 (460V, 200A, 3P, 4W) With AJA1 Angle Adaptor	
		Pyle National	NA	NA	NA	NA	JRE-4100 (230V, 100A, 3P, 4W)	
ATS	Generator Transfer Switch							
	Russelectric	NA	NA	NA	NA	RMTD Series with model 2000 controller	NEMA 12/3R 316SS Enclosure	
Odor Control Units	Biotrickling Filters	Biotrickling filters						
		BioAir	NA	NA	NA	NA		
		Bioem	NA	NA	NA	NA	Biosorbens BTF	
		Envirogen	NA	NA	NA	NA	BTF	
		Siemens	NA	NA	NA	NA	Zabocs BTF	
	Carbon Adsorption Units	Carbon Adsorption Units						
		Calgon	NA	NA	NA	NA		
		Pure Air Filtration	NA	NA	NA	NA		
		Siemens	NA	NA	NA	NA		
	Pressure Gauges	Pressure Gauges shall have Diaphragm Seals. Oil filled.						
Ashcroft		NA	NA	NA	NA	10 1008SL 02L 60#	Gauge Diaphragm Seal	
		25 200SS 02T XYTSE						
Terice		NA	NA	NA	NA	D83LFSS4002LA100 - Gauge		
						M51001SSSS - Diaphragm Seal		
Winter Gauges	NA	NA	NA	NA	D99100 Fill and Mount Charge			
Pumps	Submersible Pumps							
	ABS	NA	NA	NA	NA			
	Flygt	NA	NA	NA	NA	PFQ770 0-60 PSI D70950 top D70954 Bottom		

APPENDIX D

LIST OF APPROVED PRODUCTS - PUMP STATION SYSTEMS

FEBRUARY 11, 2011

Cat.	Desc	Manufacturer	Water		Reclaimed Water		Wastewater	
			Model #	Comments	Model #	Comments	Model #	Comments
Pumps	Floats	Float Regulator (FR) - Duplex and Triplex Pump Stations						
		Atlantic Scientific	NA	NA	NA	NA	Roto-Float	
	Radar	Radar - Pulse Burst Radar Transmitter. Input 24 VDC and Output 4-20 mA						
		Magnetrol	NA	NA	NA	NA	R82-520A-011	
Pump Station Main Ser	Main Srvce Disconnect	Main Service Disconnect Breaker						
		Square D	NA	NA	NA	NA	H or J Frame 3 Pole 600 Volt (HGL or JGL determined by amperage)	
	Surge Protector Device	Surge Protector - UL 1449, 3rd Edition listed and labeled, minimum 10 year warranty, NEMA LS-1 and IEEE C62, 41/45 tested with NEMA 4X enclosure, internal fusing, voltage and phase to match service. Rated 80,000 amps per mode for Duplex & Triplex stations and 150,000 Amperes per mode for Master Stations. All devices shall be provided with a NEMA 4X Plastic enclosure which is approved in lieu of stainless steel.						
		Current Technology (Power & Systems)	NA	NA	NA	NA	XN-80, TG-150 or CurrentGuard 150 Plus Series	
		Joslyn AKA (Total Protection Solutions)	NA	NA	NA	NA	TSS-ST 160 Series, ST 300 Series or JSP-300 Series	
		Surge Suppressors, Inc	NA	NA	NA	NA	LSE Series or SHL Series	
Sub Panel	Sub Panel	Sub-Panel Enclosure - NEMA 12/3R Enclosure 316SS, white polyester Powder coated finish inside and out, With 3 Point Pad lockable Handle, and Door Stop						
		Hoffman	NA	NA	NA	NA		
		Schaefer	NA	NA	NA	NA		
		Universal enclosure systems	NA	NA	NA	NA		
Pump Station Control Panel	Control Panel	Control Panel Supplier						
		ECS	NA	NA	NA	NA		
		Sta-Con Inc	NA	NA	NA	NA		
	Enclosure	Enclosure - NEMA 12/3R Enclosure 316SS, white polyester Powder coated finish inside and out, With 3 Point Pad lockable Handle, and Door Stop						
		Hoffman	NA	NA	NA	NA		
		Schaefer	NA	NA	NA	NA		
		Universal enclosure systems	NA	NA	NA	NA		
	Mnts	Mounting Channel for Enclosures						
		Unistrut Stainless Steel	NA	NA	NA	NA	1" 5/8 x 1" 5/8 316 SS	
	Seal-off	Explosion-Proof Sealoff						
	Cooper Crouse-Hinds	NA	NA	NA	NA	EYSR - 2 Inch Min.		
FL	Flasher (FL)							
		MPE	NA	NA	NA	NA	025-120-105	
		SSAC	NA	NA	NA	NA	FS-126	

APPENDIX D

LIST OF APPROVED PRODUCTS - PUMP STATION SYSTEMS

FEBRUARY 11, 2011

Cat.	Desc	Manufacturer	Water		Reclaimed Water		Wastewater		
			Model #	Comments	Model #	Comments	Model #	Comments	
Pump Station Control Panel	AL	Alarm Light / With Base and Globe (AL)							
	American Electric	NA	NA	NA	NA	F32552			
	Red Dot Globe	NA	NA	NA	NA	VGLR-01			
	Red Dot Base					VA-01			
	AH	Alarm Horn (AH)							
	Wheelock	NA	NA	NA	NA	3IT-115-R			
	Fuse	Fuses (F)							
	Bussmann	NA	NA	NA	NA	FNQ-R or KTK-R			
	HOA	Hand-Auto-Off Selector (HOA)							
	Square D	NA	NA	NA	NA	9001-SKS43B			
	HSS	Horn Silence Button (HSS)							
	Square D	NA	NA	NA	NA	9001-SKR1RH5			
	Inter-lock	Mechanical Interlock							
	Square D	NA	NA	NA	NA	S29354			
	Breakers	Control Panel Main Circuit Breaker (MCB) With S29450 Circuit Breaker Auxiliary Switch							
		Square D	NA	NA	NA	NA	H or J Frame 3 Pole 600 Volt (HGL or JGL determined by amperage)		
		Emergency Circuit Breaker (ECB) With S29450 Circuit Breaker Auxiliary Switch							
		Square D	NA	NA	NA	NA	H or J Frame 3 Pole 600 Volt (HGL or JGL determined by amperage)		
		Motor Circuit Breaker (MB)							
	Square D	NA	NA	NA	NA	H or J Frame 3 Pole 600 Volt (HGL or JGL determined by amperage)			
	Control Circuit Breaker/ GFCI Receptacle Breaker/ SCADA Breaker								
	Square D	NA	NA	NA	NA	QOU120			
	MS	Motor Starter (MS)							
Square D	NA	NA	NA	NA	Type S Class 8536				
OL	Overload Heater(OL)								
Square D	NA	NA	NA	NA	Part number will vary with size needed				
OR	Overload Reset								
Square D	NA	NA	NA	NA	9066-RA1				
Transformer	Control Circuit Transformer (XMFR)								
	Square D	NA	NA	NA	NA	9070TF75D23	120/24 Volt .075 KVA		
	Main Circuit Transformer (MCT)								
Square D	NA	NA	NA	NA	9070T2000D1	480/120 2KVA			
SPB	Supplemental Protector Breaker - 3 pole, 1-amp for Phase Monitor								
Square D	NA	NA	NA	NA	MG24532				

APPENDIX D

LIST OF APPROVED PRODUCTS - PUMP STATION SYSTEMS

FEBRUARY 11, 2011

Cat.	Desc	Manufacturer	Water		Reclaimed Water		Wastewater		
			Model #	Comments	Model #	Comments	Model #	Comments	
Pump Station Control Panel	PM	Phase Monitor (PM)							
		MPE 240 V.	NA	NA	NA	NA	001-230-118-OVG5		
		MPE 480 V.	NA	NA	NA	NA	002-480-123-OVG5		
	Pump Alternator	Pump Automatic Alternator (PAA)							
		Diversified Duplex	NA	NA	NA	NA	ARA-120-ACA		
		Diversified Triplex	NA	NA	NA	NA	ARA-120-AME		
		MPE Duplex	NA	NA	NA	NA	008-120-13SP		
		MPE Triplex	NA	NA	NA	NA	009-120-23P		
	MPE Triplex Socket	NA	NA	NA	NA	SD-12-PC			
	Alt. Test Switch	Alt. Test Switch							
		Carling Technologies	NA	NA	NA	NA	6GG5E-78		
		Honeywell	NA	NA	NA	NA	2TL1-50		
	Relay	Relay							
		Potter Brumfield 24 Volt	NA	NA	NA	NA	KRPA-11AN-24		
		Potter Brumfield 120 Volt	NA	NA	NA	NA	KRPA-11AN-120		
		Square D 24 Volt	NA	NA	NA	NA	8501KP12P14V14		
	Square D 120Volt	NA	NA	NA	NA	8501KP12P14V20			
	Relay Base	Relay Base							
		IEDC 8 Pin Relay Base 600 Volt	NA	NA	NA	NA	SR2P-06		
	Duplex Receptacle / GFCI	Duplex Receptacle/GFCI (DR) Upgraded to 20 Amp							
		Hubbell	NA	NA	NA	NA	GFTR20BK		
		Pass & Seymour	NA	NA	NA	NA	2095TRBK		
	ETM	Elapse Time Meter (ETM)							
		Reddington	NA	NA	NA	NA	711-0160		
	Grounding	Grounding System							
		Marathon	NA	NA	NA	NA	Neutral Isolation Block 1421570		
		Panduit	NA	NA	NA	NA	Ground Lug LAM2A 1/0 - 014 -6Y		
	Square D	NA	NA	NA	NA	Ground Buss PK7GTA			
TS	Terminal Strip (TS)								
	Marathon	NA	NA	NA	NA	Series 200			
	Square D	NA	NA	NA	NA	9080GR6			
TS	Terminal Strip End Blocks and End Clamps								
	Square D	NA	NA	NA	NA	9080GM6B & 9080GH10			

APPENDIX D

LIST OF APPROVED PRODUCTS - PUMP STATION SYSTEMS

FEBRUARY 11, 2011

Cat.	Desc	Manufacturer	Water		Reclaimed Water		Wastewater		
			Model #	Comments	Model #	Comments	Model #	Comments	
Pump Station Control Pane	PL	Pilot Light (PL) 24 Volt with 1819 Bulb							
		Dialight	NA	NA	NA	NA	803-1710		
		Lighting Components & Design	NA	NA	NA	NA	Littlelight 930507X		
	RL	Run Indicator Light (RL) 120 Volt							
		Dialight	NA	NA	NA	NA	803-1710		
		Lighting Components & Design	NA	NA	NA	NA	Littlelites 930507X With 120MB Bulb		
	MT	Moisture and Temperature Failure Light (MT) 120 Volt with 120MB Bulb							
		Dialight	NA	NA	NA	NA	803-1710		
		Lighting Components & Design	NA	NA	NA	NA	Littlelites 930507X		
Sluice Gate	Sluice Gate for Wet Well with Motorized Operator								
	BNW	NA	NA	NA	NA	Model 77 - 316 SS			
	Fontaine	NA	NA	NA	NA	Model 20 - 316 SS			
VFD	Variable Frequency Drives								
	Square D	NA	NA	NA	NA				

APPENDIX E

ORANGE COUNTY UTILITIES

BOUNDARY SURVEY(S)

(For Boundary Surveys for PS #3887, PS #3893, and PS #3890,
Please See Sheets V300, V400, and V500)

BOUNDARY SURVEY-PUMP STATION 3309
ORANGE COUNTY, FLORIDA

LEGAL DESCRIPTION:

A PORTION OF TRACT "A", RIVEN PINES, ACCORDING TO THE PLAT THEREOF, AS RECORDED IN PLAT BOOK 13, PAGE 12 OF THE PUBLIC RECORDS OF ORANGE COUNTY, FLORIDA, BEING MORE PARTICULARLY DESCRIBED AS FOLLOWS:

BEGIN AT THE NORTHWEST CORNER OF SAID TRACT "A"; THENCE RUN N89°57'30"E ALONG THE NORTH LINE OF SAID TRACT "A", A DISTANCE OF 34.40 FEET; THENCE, DEPARTING SAID NORTH LINE, RUN THE FOLLOWING COURSES AND DISTANCES: S00°09'44"W 15.84 FEET; THENCE S57°25'41"W 18.33 FEET; THENCE N89°56'53"W A DISTANCE OF 18.83 FEET TO A POINT ON THE WEST LINE OF THE AFORESAID TRACT "A"; THENCE RUN N00°09'00"W, ALONG SAID WEST LINE, A DISTANCE OF 25.66 FEET TO THE POINT OF BEGINNING.

CONTAINING 806 SQUARE FEET, MORE OR LESS.

SURVEYOR'S REPORT:

1. THIS BOUNDARY SURVEY IS NOT VALID UNLESS SIGNED AND EMBOSSED WITH A RAISED SEAL OF A FLORIDA LICENSED SURVEYOR AND MAPPER.
2. THE LIMITS OF THE BOUNDARY SURVEY ARE AS DIRECTED BY THE CLIENT.
3. THE LEGAL DESCRIPTION, SHOWN HEREON, WERE PREPARED BY THE SURVEYOR.
4. LANDS, SHOWN HEREON, WERE NOT RESEARCHED BY THIS FIRM FOR OWNERSHIP, EASEMENTS, RIGHT OF WAY OR OTHER MATTERS IN THE PUBLIC RECORDS THAT MAY AFFECT THESE LANDS.
5. BEARINGS SHOWN HEREON ARE BASED ON THE SOUTH RIGHT OF WAY LINE OF LENA STREET, AS BEING NORTH 89°57'30" EAST.
6. BEARINGS AND COORDINATES SHOWN HEREON ARE RELATIVE TO THE FLORIDA STATE PLANE COORDINATE SYSTEM EAST ZONE NORTH AMERICAN DATUM OF 1983/1990 ADJUSTMENT.
7. LAST DAY IN THE FIELD: APRIL 8, 2014.
8. GRAPHIC SYMBOLS, SHOWN HEREON, MAY NOT BE TO MAP SCALE.
9. THIS BOUNDARY SURVEY IS HEREBY CERTIFIED TO: ORANGE COUNTY, FLORIDA AND FIRST AMERICAN TITLE INSURANCE COMPANY.

SURVEYOR'S CERTIFICATION:

THIS BOUNDARY SURVEY WAS PREPARED UNDER MY DIRECTION AND IS TRUE AND CORRECT TO THE BEST OF MY KNOWLEDGE AND BELIEF. THIS BOUNDARY SURVEY WAS PERFORMED IN CONFORMANCE WITH THE "MINIMUM TECHNICAL STANDARDS FOR SURVEYS" AS CONTAINED IN CHAPTER 5J-17, FLORIDA ADMINISTRATIVE CODE, PURSUANT TO FLORIDA STATUTE 472.

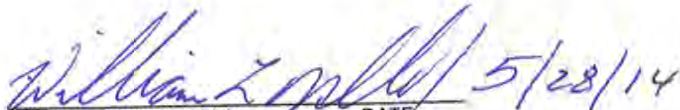
WILLIAM L. MILLER, PLS DATE 5/28/14
FLORIDA SURVEYOR AND MAPPER LS 5010
BARNES FERLAND AND ASSOCIATES LB 7774
*NOT VALID WITHOUT THE SIGNATURE AND ORIGINAL
RAISED SEAL OF THE FLORIDA LICENSED SURVEYOR AND MAPPER

THIS SURVEY CONSISTS OF TWO SHEETS AND IS NOT COMPLETE WITHOUT SHEET 2 OF 2

REVISED:
5/22/14

PER COMMENTS FROM ORANGE COUNTY

BFA Environmental Consultants
Barnes, Ferland and Associates, Inc.
1230 E. Hillcrest Street, Orlando, FL, 32803
PH: (407) 895-0000 FAX: (407) 895-1000
CERTIFICATE OF AUTHORIZATION: LB7774

BOUNDARY SURVEY
PS 3309 LENA STREET
A PORTION OF TRACT A, RIVEN PINES
PB 13, PAGE 12, ORANGE COUNTY, FLORIDA

SHEET
1 OF 2

BOUNDARY SURVEY-PUMP STATION 3309
ORANGE COUNTY, FLORIDA

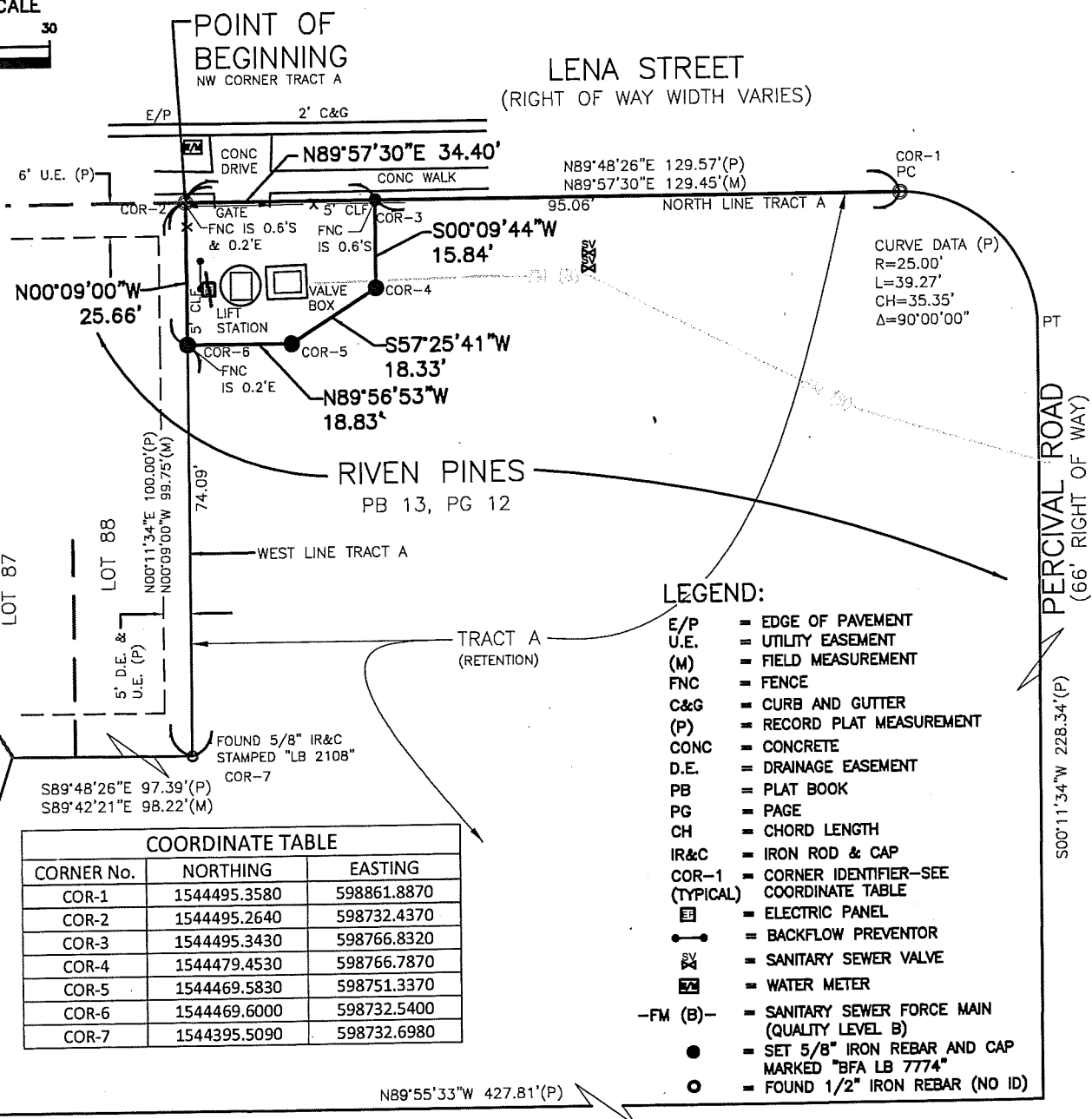
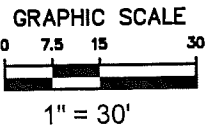

COORDINATE TABLE

CORNER No.	NORTHING	EASTING
COR-1	1544495.3580	598861.8870
COR-2	1544495.2640	598732.4370
COR-3	1544495.3430	598766.8320
COR-4	1544479.4530	598766.7870
COR-5	1544469.5830	598751.3370
COR-6	1544469.6000	598732.5400
COR-7	1544395.5090	598732.6980

THIS SURVEY CONSISTS OF TWO SHEETS AND IS NOT COMPLETE WITHOUT SHEET 1 OF 2

BFA Environmental Consultants
Barnes, Farland and Associates, Inc.
1230 E. Hillcrest Street, Orlando, FL 32803
Tel: (407) 825-1822 Fax: (407) 825-1822
CERTIFICATE OF AUTHORIZATION: LB7774

BOUNDARY SURVEY
PS 3309 LENA STREET
A PORTION OF TRACT A, RIVEN PINES
PB 13, PAGE 12, ORANGE COUNTY, FLORIDA

SHEET
2 OF 2

F:\CIVIL\PROJECTS\2011\11-11.13 Package 1 Pump Stations\5.0 Drawings\2011-11.13 Package 1 PS 3309 Boundary Survey.dwg, 5/29/2014 7:07:26 AM

UTILITY EASEMENT-PUMP STATION 3309

ORANGE COUNTY, FLORIDA

PARCEL: 801
ESTATE: PERPETUAL EASEMENT
PURPOSE: UTILITY

LEGAL DESCRIPTION:

A PORTION OF TRACT "A", RIVEN PINES, ACCORDING TO THE PLAT THEREOF, AS RECORDED IN PLAT BOOK 13, PAGE 12 OF THE PUBLIC RECORDS OF ORANGE COUNTY, FLORIDA, BEING MORE PARTICULARLY DESCRIBED AS FOLLOWS:

COMMENCE AT THE NORTHWEST CORNER OF SAID TRACT "A"; THENCE RUN N89°57'30"E ALONG THE NORTH LINE OF SAID TRACT "A", A DISTANCE OF 34.40 FEET FOR A POINT OF BEGINNING; THENCE CONTINUE N89°57'30"E ALONG SAID NORTH LINE, A DISTANCE OF 95.19 FEET TO THE POINT OF CURVATURE OF A CURVE CONCAVE SOUTHWESTERLY, HAVING A RADIUS OF 25.00 FEET; THENCE FROM A CHORD BEARING OF S45°01'30"E RUN SOUTHEASTERLY ALONG THE ARC OF SAID CURVE, THROUGH A CENTRAL ANGLE OF 90°01'59" AND AN ARC DISTANCE OF 39.27 FEET TO A POINT ON THE EAST LINE OF SAID TRACT "A", POINT ALSO BEING THE POINT OF TANGENCY; THENCE DEPARTING SAID NORTH LINE RUN S00°00'31"E ALONG SAID EAST LINE, A DISTANCE OF 106.22 FEET; THENCE, DEPARTING SAID EAST LINE, RUN THE FOLLOWING COURSES AND DISTANCES: S89°59'29"W A DISTANCE OF 10.00 FEET; THENCE N00°00'31"W A DISTANCE OF 101.23 FEET TO THE POINT OF CURVATURE OF A CURVE CONCAVE SOUTHWESTERLY HAVING A RADIUS OF 10.00 FEET; THENCE FROM A CHORD BEARING OF N45°01'30"W RUN NORTHWESTERLY ALONG THE ARC OF SAID CURVE, THROUGH A CENTRAL ANGLE OF 90°01'59" AND AN ARC DISTANCE OF 15.71 FEET TO THE POINT OF TANGENCY; THENCE S89°57'30"W A DISTANCE OF 106.78 FEET; THENCE N57°25'41"E A DISTANCE OF 7.74 FEET; THENCE N00°09'44"E A DISTANCE OF 15.84 FEET TO THE POINT OF BEGINNING.

CONTAINING 3,418 SQUARE FEET, MORE OR LESS.

SURVEYOR'S REPORT:

1. THIS LEGAL DESCRIPTION IS NOT VALID UNLESS SIGNED AND EMBOSSED WITH A RAISED SEAL OF A FLORIDA LICENSED SURVEYOR AND MAPPER.
2. THE LIMITS OF THIS UTILITY EASEMENT AREA IS AS DIRECTED BY THE CLIENT.
3. THE LEGAL DESCRIPTION, SHOWN HEREON, WAS PREPARED BY THE SURVEYOR.
4. LANDS, SHOWN HEREON, WERE NOT RESEARCHED BY THIS FIRM FOR OWNERSHIP, EASEMENTS, RIGHT OF WAY OR OTHER MATTERS IN THE PUBLIC RECORDS THAT MAY AFFECT THESE LANDS.
5. BEARINGS SHOWN HEREON ARE BASED ON THE SOUTH RIGHT OF WAY LINE OF LENA STREET, AS BEING NORTH 89°57'30" EAST.
6. BEARINGS AND COORDINATES SHOWN HEREON ARE RELATIVE TO THE FLORIDA STATE PLANE COORDINATE SYSTEM EAST ZONE NORTH AMERICAN DATUM OF 1983/1990 ADJUSTMENT.
7. GRAPHIC SYMBOLS, SHOWN HEREON, MAY NOT BE TO MAP SCALE.
8. LAST DAY IN THE FIELD: APRIL 8, 2014.
9. THIS SKETCH OF DESCRIPTION IS HEREBY CERTIFIED TO: ORANGE COUNTY, FLORIDA AND FIRST AMERICAN TITLE INSURANCE COMPANY.
10. THIS IS NOT A BOUNDARY SURVEY.

SURVEYOR'S CERTIFICATION:

THIS LEGAL DESCRIPTION WAS PREPARED UNDER MY DIRECTION AND IS TRUE AND CORRECT TO THE BEST OF MY KNOWLEDGE AND BELIEF. THIS LEGAL DESCRIPTION WAS PERFORMED IN CONFORMANCE WITH THE "MINIMUM TECHNICAL STANDARDS FOR SURVEYS" AS CONTAINED IN CHAPTER 5J-17, FLORIDA ADMINISTRATIVE CODE, PURSUANT TO FLORIDA STATUTE 472.

William L. Miller
WILLIAM L. MILLER, PLS

DATE

FLORIDA SURVEYOR AND MAPPER LS 5010

BARNES FERLAND AND ASSOCIATES LB 7774

*NOT VALID WITHOUT THE SIGNATURE AND ORIGINAL

RAISED SEAL OF THE FLORIDA LICENSED SURVEYOR AND MAPPER

THIS LEGAL DESCRIPTION CONSISTS OF 2 SHEETS
AND IS NOT COMPLETE WITHOUT SHEET 2 OF 2

REVISED:

5/22/14

PER COMMENTS FROM ORANGE COUNTY

BFA Environmental Consultants
Barnes, Ferland and Associates, Inc.
1230 E. Hillcrest Street, Orlando, FL, 32809
PH: (407) 806-8800 FAX: (407) 806-5800
CERTIFICATE OF AUTHORIZATION: LB7774

LEGAL DESCRIPTION

UTILITY EASEMENT - PUMP STATION 3309
A PORTION OF TRACT A, RIVEN PINES
PB 13, PAGE 12, ORANGE COUNTY, FLORIDA

SHEET
1 OF 2

UTILITY EASEMENT -PUMP STATION 3309

ORANGE COUNTY, FLORIDA
SKETCH OF DESCRIPTION

LEGEND:

- | | |
|-----------------------------|--|
| POB = POINT OF BEGINNING | ☐ = DRAINAGE INLET |
| U.E. = UTILITY EASEMENT | ⊗ = WOOD UTILITY POLE |
| (M) = FIELD MEASUREMENT | ⊖ = GUY ANCHOR |
| POC = POINT OF COMMENCEMENT | ⊕ = ELECTRIC METER |
| LS = LIFT STATION | ⊥ = METAL SIGN |
| PC = POINT OF CURVATURE | ⊠ = ELECTRIC BOX |
| D.E. = DRAINAGE EASEMENT | ● = SET IRON ROD AND CAP STAMPED "LB 7774" |
| PB = PLAT BOOK | ⊙ = FOUND 1/2" IRON REBAR NO ID. |
| (M) = FIELD MEASUREMENT | ⊠ = FOUND 4"x4" CONCRETE (ILLEGIBLE) |
| (P) = PLAT | -OHU- = OVERHEAD UTILITY |
| PG = PAGE | -TV(B)- = CABLE TELEVISION |
| PT = POINT OF TANGENCY | COR-1 = CORNER IDENTIFIER-SEE |
| (C) = CALCULATED | (TYPICAL) COORDINATE TABLE |
| E/P = EDGE OF PAVEMENT | |
| C&G = CURB AND GUTTER | |
| -X- = CHAIN LINK FENCE | |

LENA STREET
(RIGHT OF WAY WIDTH VARIES)

R=25.00'(P)(C)
L=39.27'(P)
39.28'(C)
Δ=90°00'00"(P)
90°01'59"(C)
CB=S45°01'30"E

E/P 2' C&G

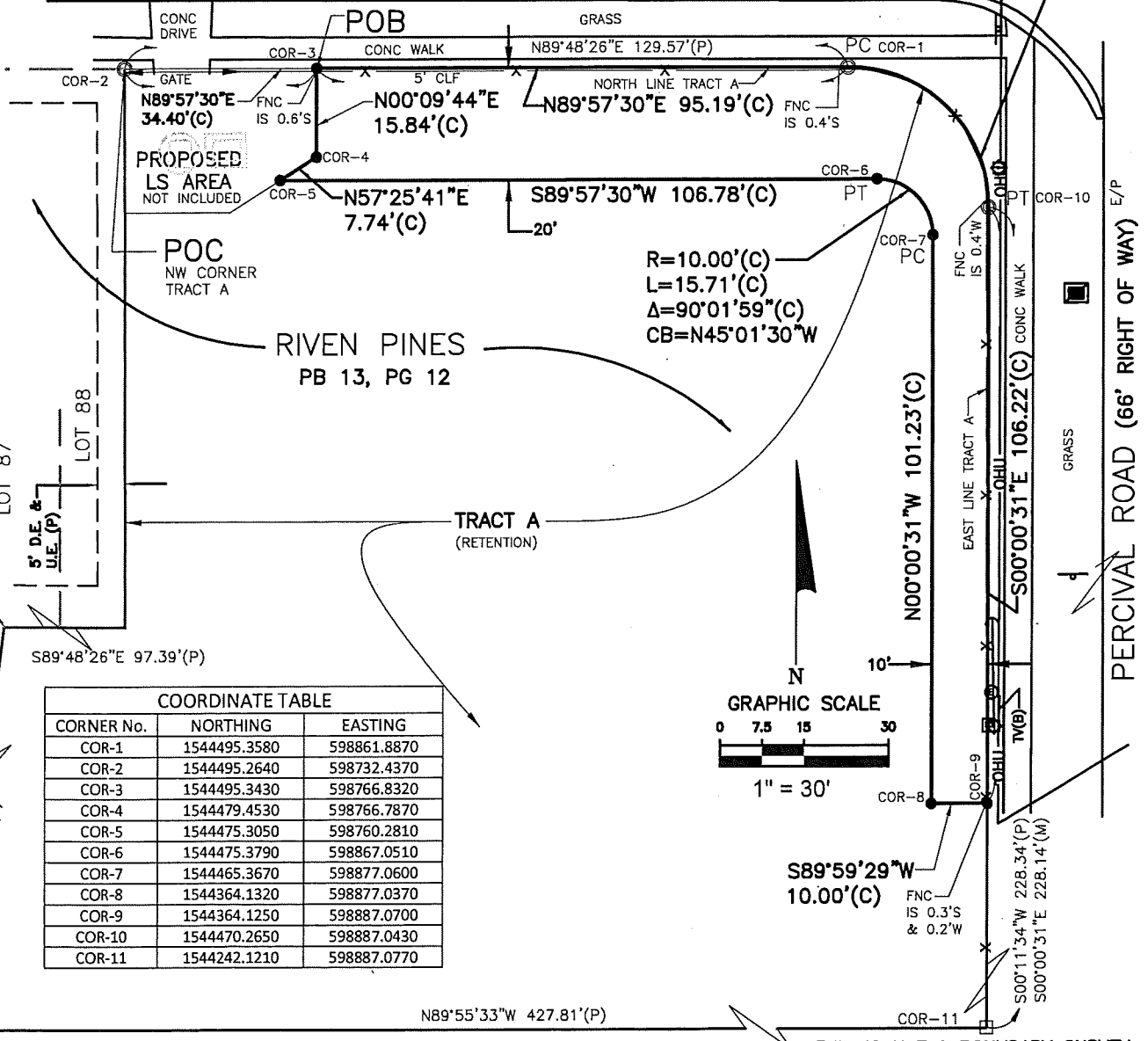

COORDINATE TABLE		
CORNER No.	NORTHING	EASTING
COR-1	1544495.3580	598861.8870
COR-2	1544495.2640	598732.4370
COR-3	1544495.3430	598766.8320
COR-4	1544479.4530	598766.7870
COR-5	1544475.3050	598760.2810
COR-6	1544475.3790	598867.0510
COR-7	1544465.3670	598877.0600
COR-8	1544364.1320	598877.0370
COR-9	1544364.1250	598887.0700
COR-10	1544470.2650	598887.0430
COR-11	1544242.1210	598887.0770

THIS LEGAL DESCRIPTION CONSISTS OF 2 SHEETS AND IS NOT COMPLETE WITHOUT SHEET 1 OF 2 THIS IS NOT A BOUNDARY SURVEY

BFA Environmental Consultants
Barnes, Ferland and Associates, Inc.
1230 E Hillcrest Street, Orlando, FL, 32803
PH: (407) 806-8000 FAX: (407) 806-1882
CERTIFICATE OF AUTHORIZATION: LB7774

LEGAL DESCRIPTION
UTILITY EASEMENT-PUMP STATION 3309
A PORTION OF TRACT A, RIVEN PINES
PB 13, PAGE 12, ORANGE COUNTY, FLORIDA

SHEET
2 OF 2

F:\CIVIL\PROJECTS\2011\11-11.13 Package 1 Pump Stations\5.0 Drawings\2011-11.13 Package 1 PS 3309 FM SOD.dwg, 5/27/2014 6:01:15 PM

PUMP STATION 3365 IMPROVEMENTS BOUNDARY SURVEY

COORDINATE TABLE

CORNER No.	NORTHING	EASTING
COR-1	1549966.0770	583197.9740
COR-2	1549965.8710	583175.4340
COR-3	1549898.5530	583175.4180
COR-4	1549898.7560	583198.5460
COR-7	1549966.3050	583235.2190
COR-8	1549899.2760	583236.3570

UNIVERSITY BLVD
(R/W VARIES)

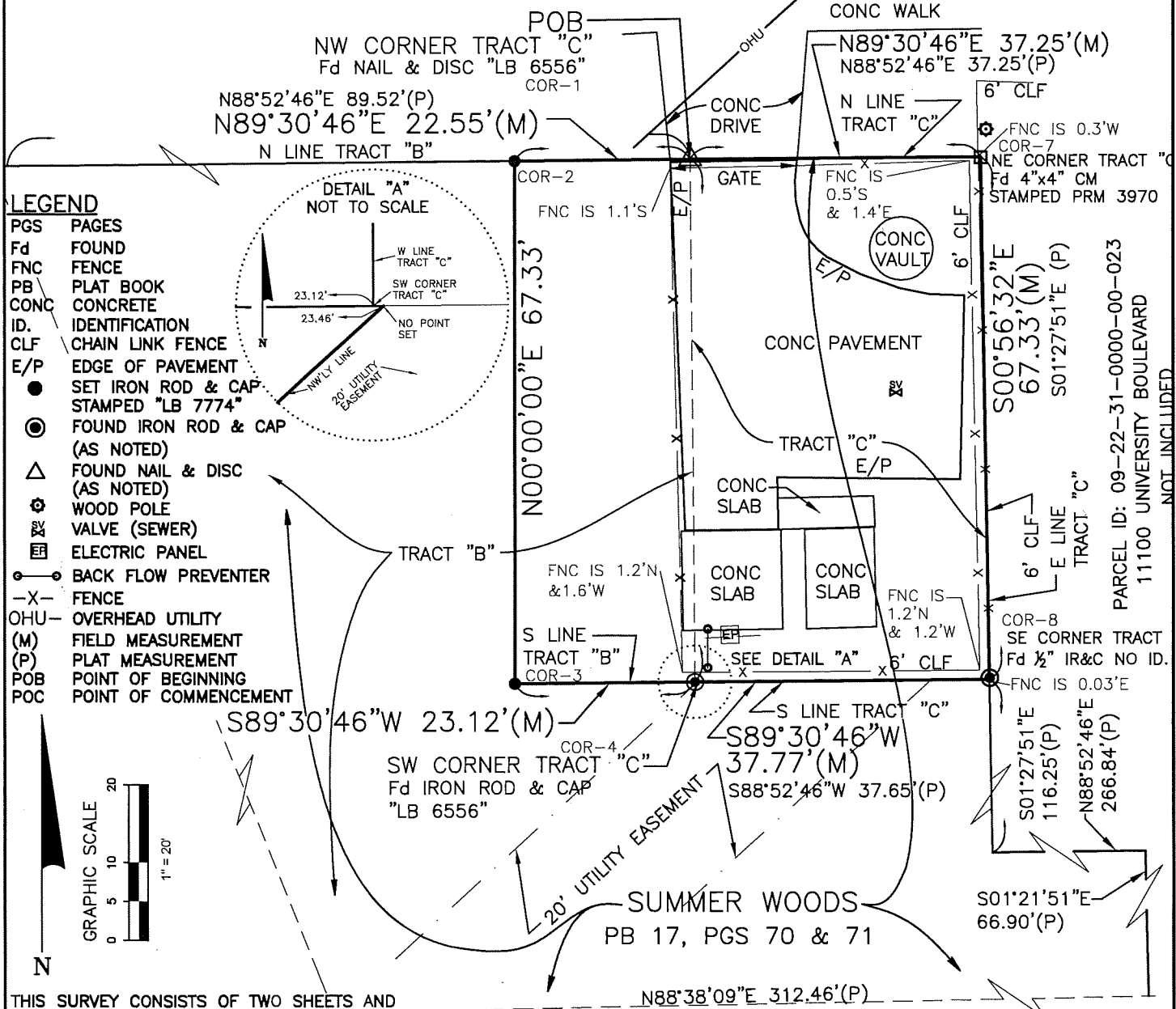

- LEGEND**
- PGS PAGES
 - Fd FOUND
 - FNC FENCE
 - PB PLAT BOOK
 - CONC CONCRETE
 - ID. IDENTIFICATION
 - CLF CHAIN LINK FENCE
 - E/P EDGE OF PAVEMENT
 - SET IRON ROD & CAP STAMPED "LB 7774"
 - ⊙ FOUND IRON ROD & CAP (AS NOTED)
 - △ FOUND NAIL & DISC (AS NOTED)
 - ⊗ WOOD POLE
 - ⊕ VALVE (SEWER)
 - ⊞ ELECTRIC PANEL
 - ⊖ BACK FLOW PREVENTER
 - X- FENCE
 - OHU OVERHEAD UTILITY
 - (M) FIELD MEASUREMENT
 - (P) PLAT MEASUREMENT
 - POB POINT OF BEGINNING
 - POC POINT OF COMMENCEMENT

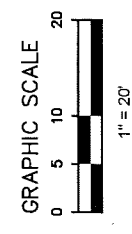
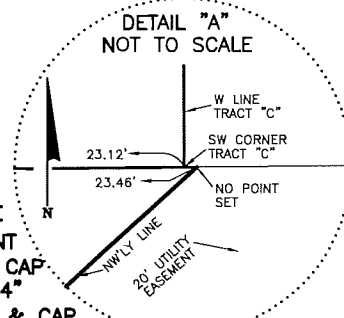

THIS SURVEY CONSISTS OF TWO SHEETS AND IS NOT COMPLETE WITHOUT SHEET 2 OF 2.

PARCEL ID: 09-22-31-0000-00-023
 11100 UNIVERSITY BOULEVARD
 NOT INCLUDED

<p>BFA Environmental Consultants Barnes, Ferland and Associates, Inc. 1230 E. Hillcrest Street, Orlando, FL 32803 PH: (407) 896-8808 FAX: (407) 896-1883 CERTIFICATE OF AUTHORIZATION: LB7774</p>	<p>BOUNDARY SURVEY A PORTION OF TRACT "B" AND TRACT "C", SUMMER WOODS, PB 17, PAGES 70 & 71 11098 UNIVERSITY BOULEVARD</p>	<p>SHEET 2 OF 2</p>
--	---	-------------------------

F:\CIVIL\PROJECTS\2011\11-11.13 Package 1 Pump Stations\5.0 Drawings\2011-11-13 Package 1 PS 3365 Boundary.dwg, 6/2/2014 2:13:54 PM

**PUMP STATION 3365 IMPROVEMENTS
UTILITY EASEMENT**

PARCEL: 801
ESTATE: PERPETUAL EASEMENT
PURPOSE: UTILITY

Legal Description:

A portion of Tract "B", Summer Woods, according to the plat thereof, as recorded in Plat Book 17, page 70 of the public records of Orange County, described as follows:

Commence at the northwest corner of Tract "C" of said Summer Woods for a point of reference; thence run South 89°30'46" West, along the north line of said Tract "B", a distance of 22.55 feet to the Point of Beginning; thence run South 00°00'00" West, 67.33 feet; thence run North 89°30'46" East, 23.46 feet; thence run South 47°33'49" West, along the northwesterly line of an existing utility easement as per said plat, a distance of 53.47 feet; thence run North 00°00'00" East, 103.07 feet to a point on the north line of said Tract "B"; thence run North 89° 30' 46" East, along said north line, a distance of 16.00 feet to the Point of Beginning.

Containing 1,776 square feet, more or less.

Surveyor's Report:

1. This Legal Description is not valid unless signed and embossed with a raised seal of a Florida licensed Surveyor and Mapper.
2. The limits of the Boundary Survey are as directed by the client.
3. The Legal Descriptions, shown hereon, were prepared by the surveyor.
4. Lands, shown hereon, were not researched by this firm for ownership, easements, right of way or other matters in the public records that may affect these lands.
5. Bearings shown hereon are based on the North line of Tract "C", as being North 89°30'46" East.
6. Bearings and coordinates shown hereon are relative to the Florida State Plane Coordinate System, East Zone North American Datum of 1983.
7. Last day in the field: March 17, 2014.
8. Graphic symbols, shown hereon, may not be to map scale.
9. This is not a Boundary Survey.
10. This Sketch of Description is hereby certified to: Orange County, Florida and First American Title Insurance Company.

Surveyor's Certification:

This Legal Description was prepared under my direction and is true and correct to the best of my knowledge and belief. This Legal Description was performed in conformance with the "Minimum Technical Standards for Surveys" as contained in Chapter 5J-17, Florida Administrative Code, pursuant to Florida Statute 472.

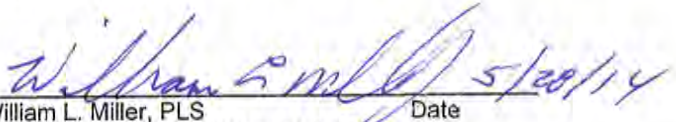
William L. Miller, PLS Date
Florida Surveyor and Mapper LS 5010
Barnes Ferland and Associates LB 7774

*Not valid without the signature and original raised seal of the Florida licensed surveyor and mapper

THIS SKETCH CONSISTS OF TWO SHEETS AND IS NOT COMPLETE WITHOUT SHEET 2 AND 2.

REVISED:
5/27/14

PER COMMENTS FROM ORANGE COUNTY

BFA Environmental Consultants
Barnes, Ferland and Associates, Inc.
1290 E. Hillcrest Street, Orlando, FL, 32803
PH: (407) 894-8808 FAX: (407) 894-1082
CERTIFICATE OF AUTHORIZATION: LB7774

LEGAL DESCRIPTION
TRACT "B", SUMMER WOODS, PB 17, PAGES 70 & 71
11098 UNIVERSITY BOULEVARD

SHEET
1 OF 2

PUMP STATION 3365 IMPROVEMENTS UTILITY EASEMENT SKETCH OF DESCRIPTION

COORDINATE TABLE

CORNER No.	NORTHING	EASTING
COR-1	1549966.0770	583197.9740
COR-2	1549965.8710	583175.4340
COR-3	1549898.5530	583175.4180
COR-4	1549898.7560	583198.5460
COR-5	1549862.6650	583159.4410
COR-6	1549965.7350	583159.4220

UNIVERSITY BLVD
(R/W VARIES)

POC
NW CORNER
TRACT "C"
Fd NAIL & DISC
"LB 6556"

CONC DRIVE

GATE

CONC VAULT

LEGEND

- FNC FENCE
- PB PLAT BOOK
- PGS PAGES
- Fd FOUND
- ID. IDENTIFICATION
- CLF CHAIN LINK FENCE
- E/P EDGE OF PAVEMENT
- (P) PLAT MEASUREMENT
- (M) FIELD MEASUREMENT
- SET IRON ROD & CAP
STAMPED "LB 7774"
- ⊙ FOUND IRON ROD & CAP
(AS NOTED)
- △ FOUND NAIL & DISC
(AS NOTED)
- X- FENCE
- POB POINT OF BEGINNING
- POC POINT OF COMMENCEMENT

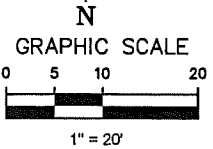
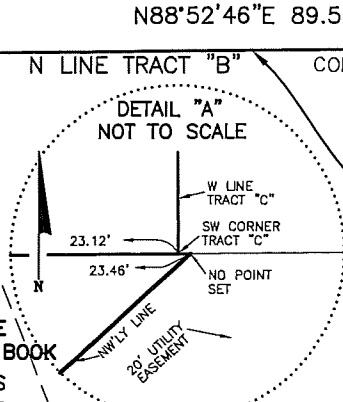

THIS IS NOT A BOUNDARY SURVEY.
THIS SKETCH CONSISTS OF TWO SHEETS AND
IS NOT COMPLETE WITHOUT SHEET 1 OF 2.

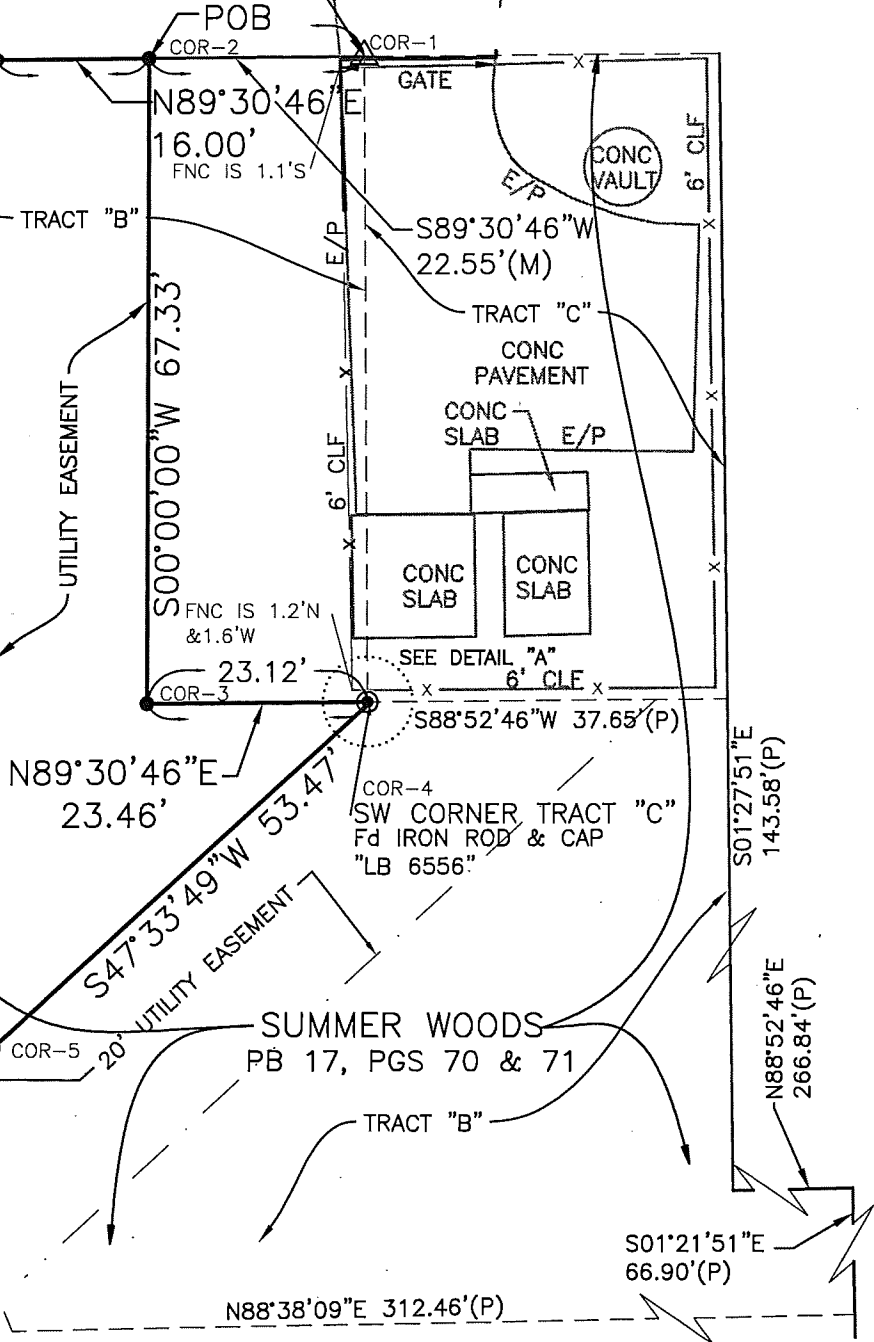

LEGAL DESCRIPTION

TRACT "B", SUMMER WOODS, PB 17, PAGES 70 & 71
11098 UNIVERSITY BOULEVARD

SHEET
2 OF 2

BFA Environmental Consultants
Bernes, Farland and Associates, Inc.
1230 E. Hillcrest Street, Orlando, FL 32803
TEL: (407) 806-8800 FAX: (407) 806-1882
CERTIFICATE OF AUTHORIZATION: LB7774

BOUNDARY & TOPOGRAPHIC SURVEY

PUMP STATION 3309

LYING IN A PORTION OF
SECTION 14, TOWNSHIP 22 SOUTH, RANGE 31 EAST
ORANGE COUNTY, FLORIDA

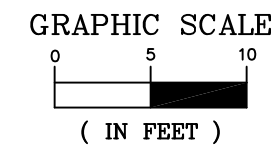

LEGAL DESCRIPTION - PUMP STATION 3309

THE NORTH LINE AND WEST LINE OF TRACT A, RIVEN PINES, ACCORDING TO THE PLAT THEREOF, AS RECORDED IN PLAT BOOK 13, PAGE 12 OF THE PUBLIC RECORDS OF ORANGE COUNTY, FLORIDA.

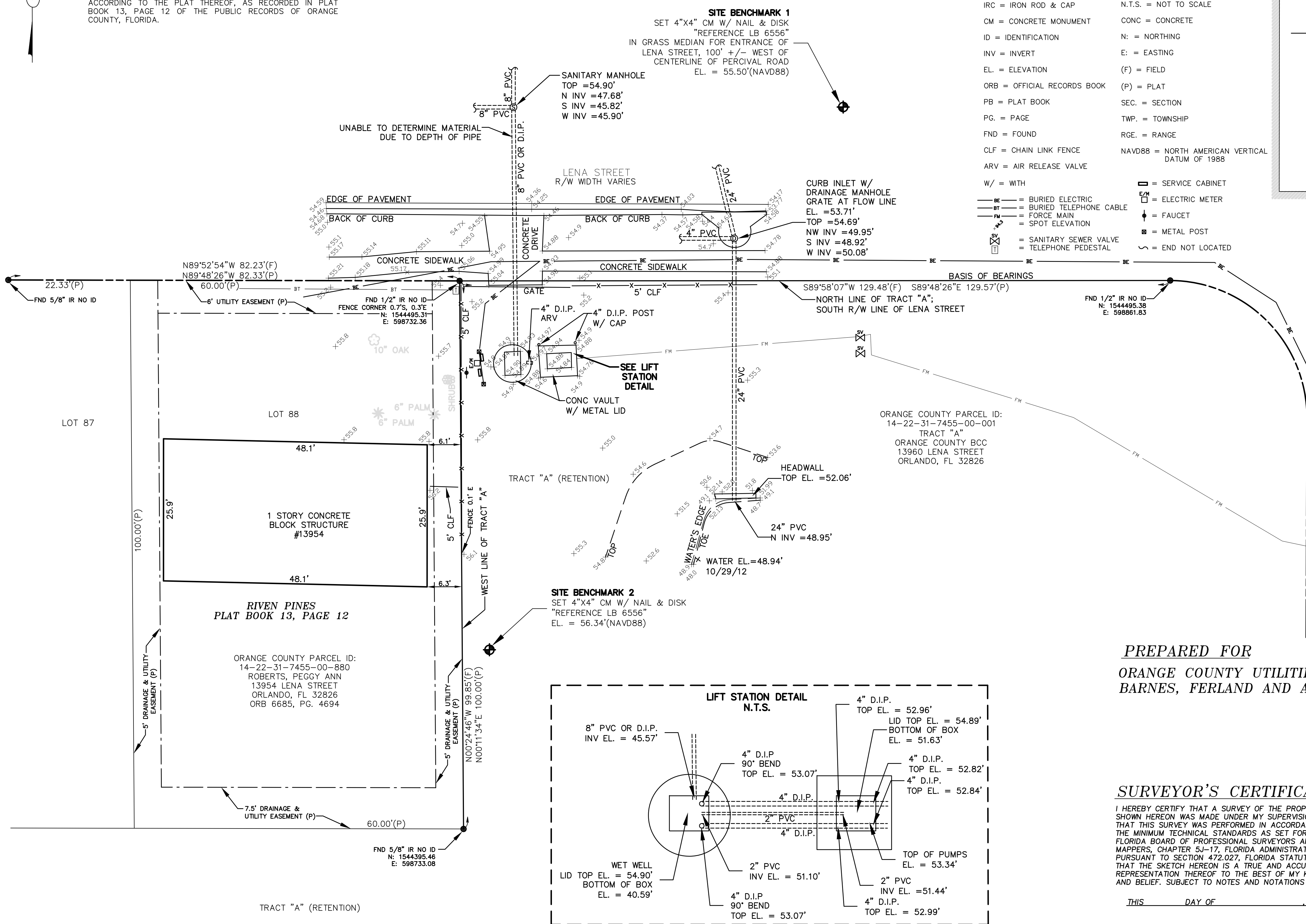

LEGEND & ABBREVIATIONS

R/W = RIGHT OF WAY	D.I.P. = DUCTILE IRON PIPE
PVC = POLYVINYL CHLORIDE	TOP = TOP OF BANK
IR = IRON ROD	TOE = BOTTOM OF BANK
IRC = IRON ROD & CAP	N.T.S. = NOT TO SCALE
CM = CONCRETE MONUMENT	CONC = CONCRETE
ID = IDENTIFICATION	N = NORTHING
INV = INVERT	E = EASTING
EL = ELEVATION	(F) = FIELD
ORB = OFFICIAL RECORDS BOOK	(P) = PLAT
PB = PLAT BOOK	SEC. = SECTION
PG. = PAGE	TWP. = TOWNSHIP
FND = FOUND	RGE. = RANGE
CLF = CHAIN LINK FENCE	NAVD88 = NORTH AMERICAN VERTICAL DATUM OF 1988
ARV = AIR RELEASE VALVE	
W/ = WITH	☐ = SERVICE CABINET
— BE — = BURIED ELECTRIC	⊠ = ELECTRIC METER
— BT — = BURIED TELEPHONE CABLE	⬇ = FAUCET
— FM — = FORCE MAIN	⊠ = METAL POST
• = SPOT ELEVATION	— = END NOT LOCATED
⊠ = SANITARY SEWER VALVE	
⊠ = TELEPHONE PEDESTAL	

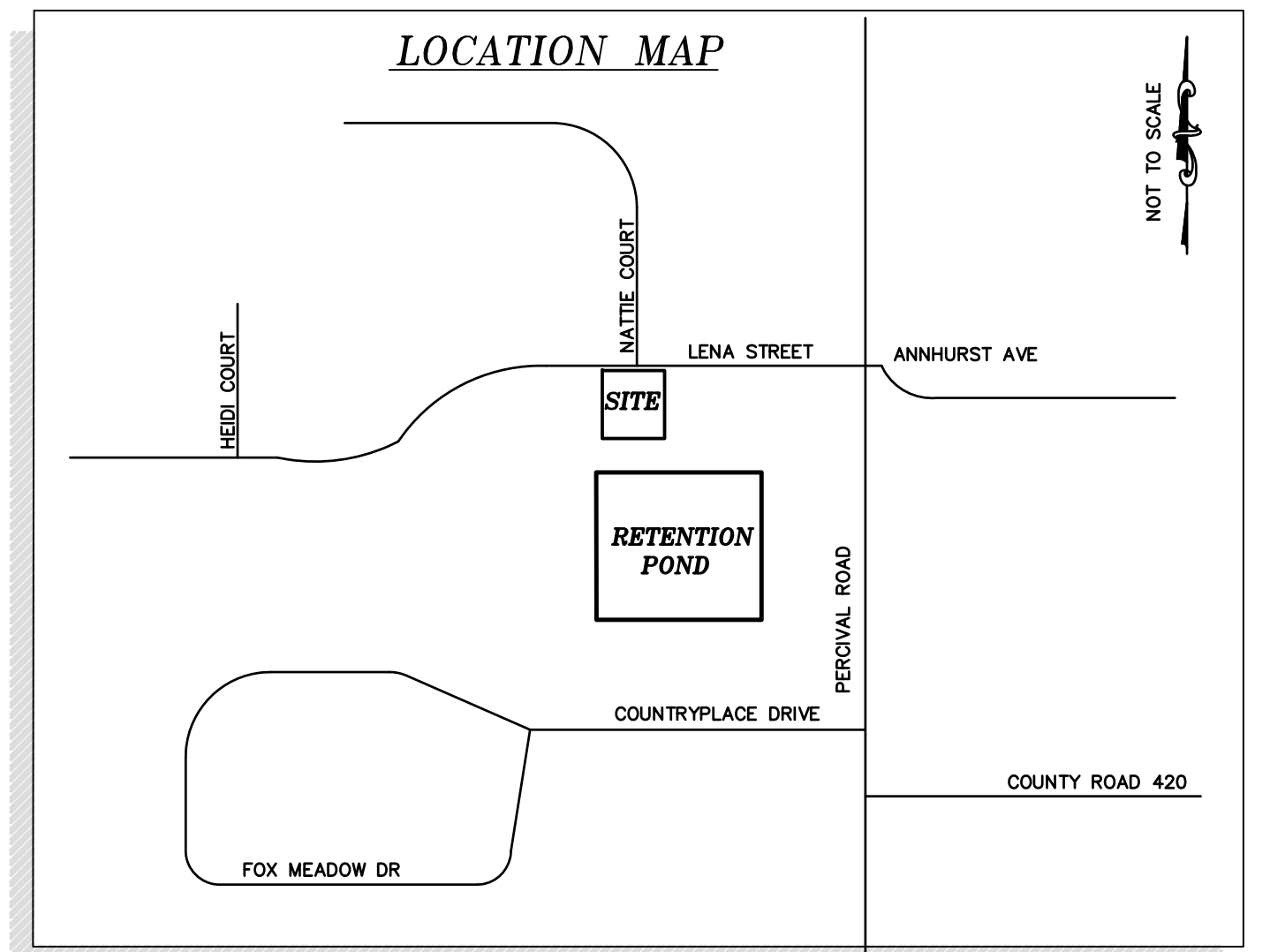

SURVEYOR'S REPORT

- THE PURPOSE OF THIS SURVEY IS TO ESTABLISH THE LIMITS OF THE PROPERTY DESCRIBED IN THE LEGAL DESCRIPTION SHOWN HEREON BY ESTABLISHING OR RE-ESTABLISHING CORNERS, MONUMENTS AND BOUNDARY LINES, AND TO ESTABLISH THE HORIZONTAL AND VERTICAL SPATIAL RELATIONSHIP OF THE NATURAL OR MANMADE FEATURES LYING WITHIN THE DEFINED TOPOGRAPHIC SURVEY LIMITS NOTED BELOW.
- THE LIMITS OF THE TOPOGRAPHIC SURVEY IS THE EXISTING PUMP STATION IMPROVEMENTS AND APPROXIMATELY 25 FEET OUTSIDE OF SAID PUMP STATION.
- BEARINGS AND COORDINATES SHOWN HEREON ARE RELATIVE TO THE FLORIDA STATE PLANE COORDINATE SYSTEM, NORTH AMERICAN DATUM OF 1983/2007 ADJUSTMENT (NAD83/07), ADJUSTMENT, ZONE 901, FLORIDA EAST, WITH THE NORTH LINE OF TRACT A HAVING A BEARING OF SOUTH 89°58'07" WEST.
- ELEVATIONS SHOWN HEREON ARE RELATIVE TO THE NORTH AMERICAN VERTICAL DATUM OF 1988 (NAVD88) AS ESTABLISHED FROM THE FOLLOWING ORANGE COUNTY BENCHMARKS:
C803020.
FOUND 2" ORANGE COUNTY BRASS CONTROL DISC IN NORTH CENTER OF DROP INLET ON WEST SIDE PERCIVAL ROAD, SOUTH OF LAKE PICKETT ROAD
PUBLISHED ELEVATION = 51.105 FEET (NAVD88)
L1090066
FOUND 2 1/4" ORANGE COUNTY BRASS CONTROL DISC IN HEAD WALL +/- 30 FEET EAST OF C/L OF PERCIVAL ROAD. ACROSS FROM ADDRESS 2822
PUBLISHED ELEVATION = 57.387 FEET (NAVD88)
- THE SURVEYOR HAS NOT ABSTRACTED THE LANDS SHOWN HEREON FOR EASEMENTS AND/OR RIGHT-OF-WAY RECORDS. THIS SURVEY WAS PREPARED WITHOUT THE BENEFIT OF A TITLE REPORT.
- THE LOCATION OF UNDERGROUND UTILITY LINES SHOWN HEREON WERE DETERMINED BY A COMBINATION OF PHYSICAL MARKING MADE BY THE UTILITY COMPANIES IN RESPONSE TO CALL SUNSHINE LOCATE REQUEST, TICKET NUMBER 271206677, FIELD MARKINGS BY BARNES, FERLAND AND ASSOCIATES INC., AND BY EXAMINATION OF SURFACE APPURTENANCES OF SAID UTILITIES. NO UNDERGROUND INSTALLATIONS OR IMPROVEMENTS HAVE BEEN LOCATED EXCEPT AS SHOWN.
- ALL RECORDING REFERENCES SHOWN ON THIS SURVEY REFER TO THE PUBLIC RECORDS OF ORANGE COUNTY, FLORIDA, UNLESS OTHERWISE NOTED.
- UNLESS IT BEARS THE SIGNATURE AND THE ORIGINAL RAISED SEAL OF A FLORIDA LICENSED SURVEYOR AND MAPPER THIS DRAWING, SKETCH, PLAT, OR MAP IS FOR INFORMATIONAL PURPOSES ONLY AND IS NOT VALID.
- ACCORDING TO THE FLOOD INSURANCE RATE MAP (FIRM), DATED SEPTEMBER 25, 2009 THE SURVEY LIMITS SHOWN HEREON APPEARS TO BE IN FLOOD "ZONE X". AREAS DETERMINED TO BE OUTSIDE THE 0.2% ANNUAL CHANCE FLOODPLAIN, AS LOCATED ON COMMUNITY PANEL NO. 120179-0285-F, MAP NUMBER 12095C0285F.

PREPARED FOR
ORANGE COUNTY UTILITIES
BARNES, FERLAND AND ASSOCIATES, INC.

SURVEYOR'S CERTIFICATION

I HEREBY CERTIFY THAT A SURVEY OF THE PROPERTY SHOWN HEREON WAS MADE UNDER MY SUPERVISION AND THAT THIS SURVEY WAS PERFORMED IN ACCORDANCE WITH THE MINIMUM TECHNICAL STANDARDS AS SET FORTH BY THE FLORIDA BOARD OF PROFESSIONAL SURVEYORS AND MAPPERS, CHAPTER 5J-17, FLORIDA ADMINISTRATIVE CODE, PURSUANT TO SECTION 472.027, FLORIDA STATUTES AND THAT THE SKETCH HEREON IS A TRUE AND ACCURATE REPRESENTATION HEREOF TO THE BEST OF MY KNOWLEDGE AND BELIEF. SUBJECT TO NOTES AND NOTATIONS SHOWN

THIS DAY OF _____, 20____

H. Paul deVivero, Professional Land Surveyor No. 4990
Land Surveyor Business License No. 6556
VALID ONLY WITH SIGNATURE AND EMBOSSED SEAL

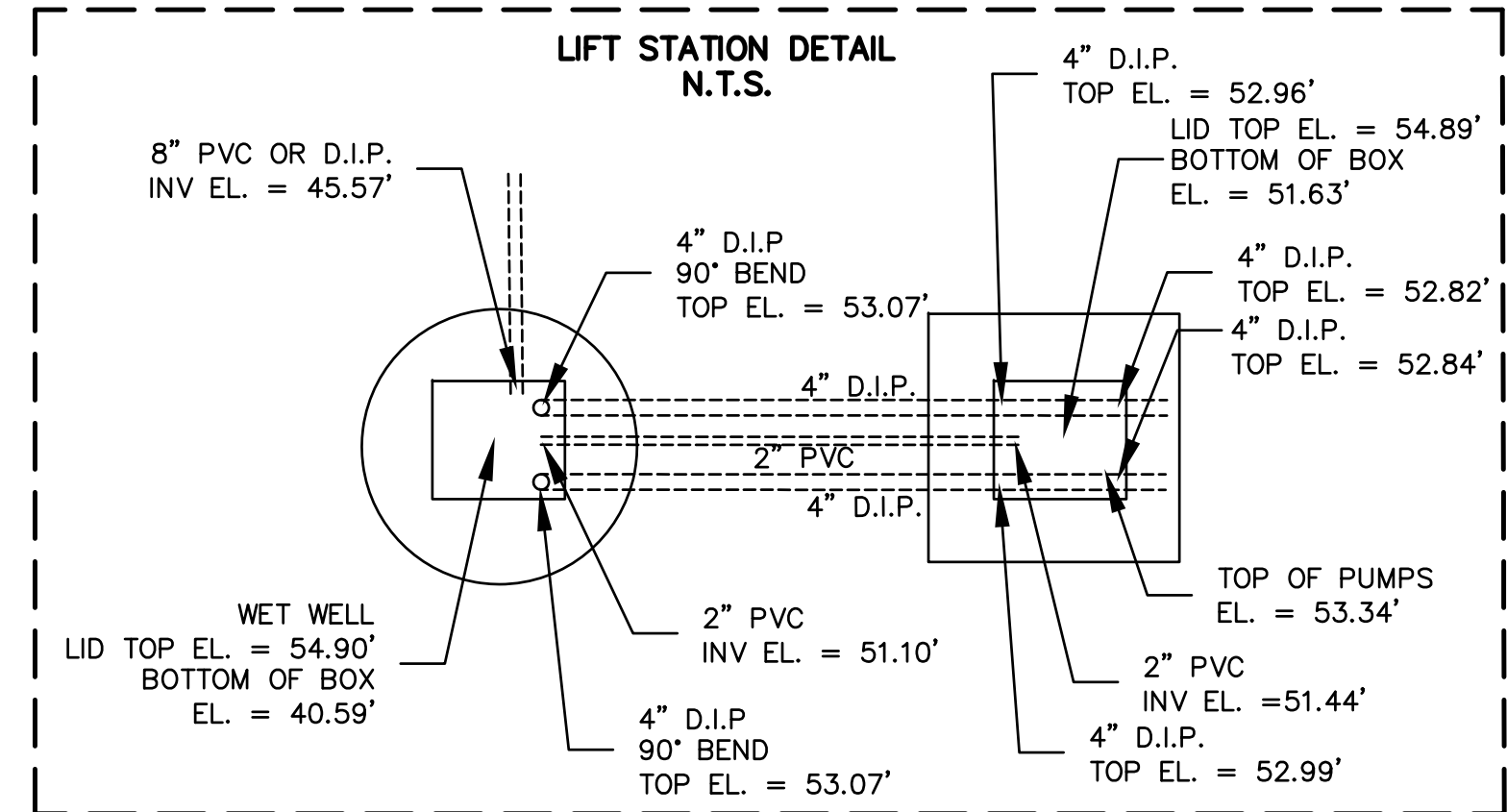

GEODATA CONSULTANTS, INC. SURVEYING & MAPPING 2700 WESTHALL LANE SUITE 137 MAITLAND, FLORIDA 32751 VOICE: (407) 660-2322 FAX: 660-8223		DRAWN BY: DPW	CHECKED BY: RHJ/IMS
		DATE OF FIELD SURVEY: OCTOBER 29, 2012	FIELD BOOK NUMBER: 18-06; PAGES 24-43
		SEC. 14, TWP. 22 S., RGE. 31 E.	ORANGE COUNTY, FLORIDA
No.	DATE	REVISION	DATE: OCTOBER 30, 2012
			SCALE: 1" = 10'
			PROJECT No. SHEET
			B18-14 OF 1

BOUNDARY & TOPOGRAPHIC SURVEY

PUMP STATION 3365

LYING IN A PORTION OF
SECTION 9, TOWNSHIP 22 SOUTH, RANGE 31 EAST
ORANGE COUNTY, FLORIDA

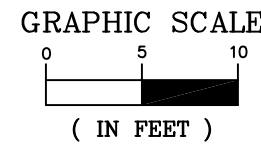

LEGAL DESCRIPTION - PUMP STATION 3365

TRACT C, SUMMER WOODS, ACCORDING TO THE PLAT THEREOF, AS RECORDED IN PLAT BOOK 17, PAGES 70 THROUGH 71 OF THE PUBLIC RECORDS OF ORANGE COUNTY, FLORIDA.

SANITARY MANHOLE
TOP = 52.13'
NE INV = 37.59'
S INV = 37.27'
W INV = 37.29'

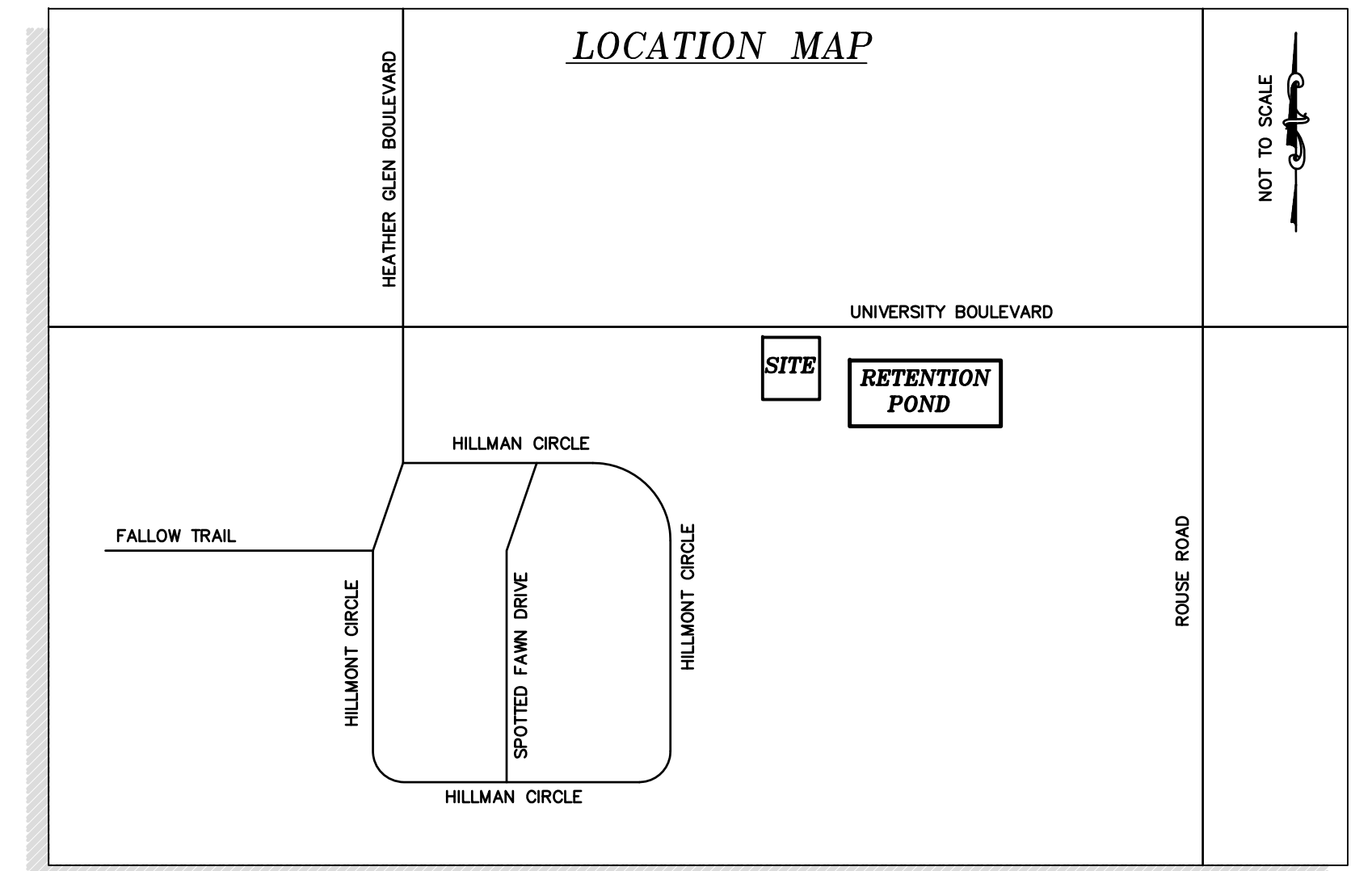
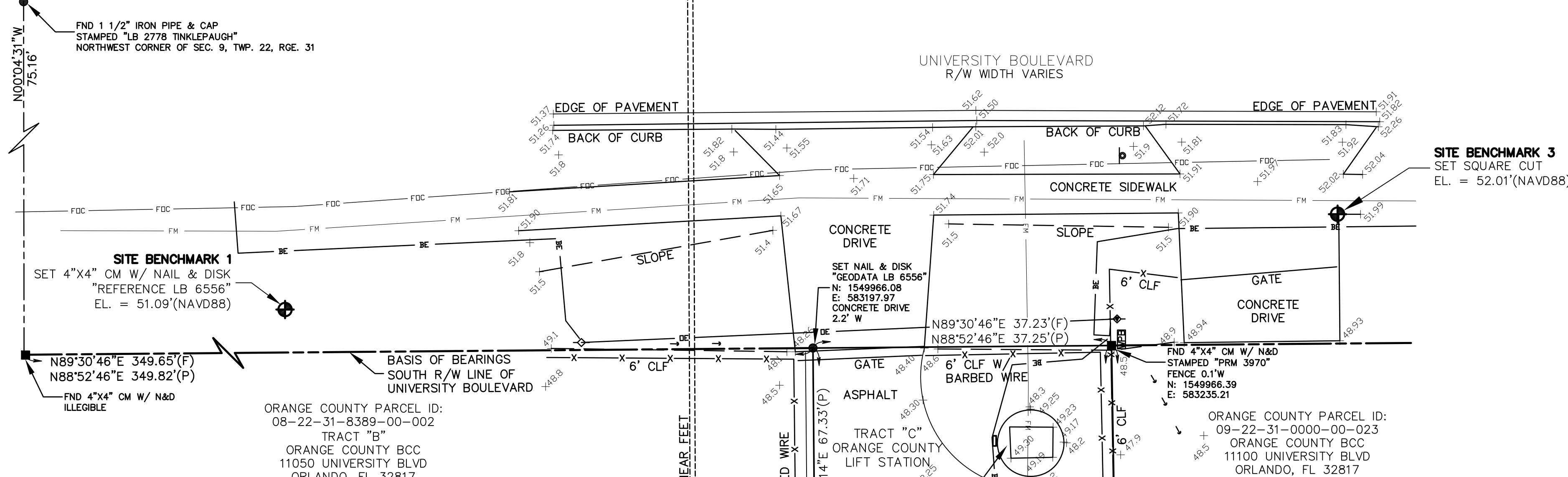

SURVEYOR'S REPORT

- THE PURPOSE OF THIS SURVEY IS TO ESTABLISH THE LIMITS OF THE PROPERTY DESCRIBED IN THE LEGAL DESCRIPTION SHOWN HEREON BY ESTABLISHING OR RE-ESTABLISHING CORNERS, MONUMENTS AND BOUNDARY LINES, AND TO ESTABLISH THE HORIZONTAL AND VERTICAL SPATIAL RELATIONSHIP OF THE NATURAL OR MANMADE FEATURES LYING WITHIN THE DEFINED TOPOGRAPHIC SURVEY LIMITS NOTED BELOW.
- BEARINGS AND COORDINATES SHOWN HEREON ARE RELATIVE TO THE FLORIDA STATE PLANE COORDINATE SYSTEM, NORTH AMERICAN DATUM OF 1983/2007 ADJUSTMENT (NAD83/07), ADJUSTMENT, ZONE 901, FLORIDA EAST, WITH THE SOUTH RIGHT OF WAY LINE OF UNIVERSITY BOULEVARD HAVING A BEARING OF NORTH 89°30'46" EAST.
- ELEVATIONS SHOWN HEREON ARE RELATIVE TO THE NORTH AMERICAN VERTICAL DATUM OF 1988 (NAVD88) AS ESTABLISHED FROM THE FOLLOWING ORANGE COUNTY BENCHMARKS:
 - L1010008 FOUND 2 1/2" ORANGE COUNTY BRASS CONTROL DISC IN CURB-INLET, NORTHEAST SIDE OF CURB-INLET AND ON SOUTHWEST CORNER OF HILLMONT CR. AND SEPTER DR. PUBLISHED ELEVATION = 55.353 FEET (NAVD88)
 - L1010006 FOUND 2 1/2" ORANGE COUNTY BRASS CONTROL DISC IN EAST SIDE OF CURB-INLET ON THE EAST SIDE OF HEATHER GLEN, +/- 400 FT NORTH OF C/L OF UNIVERSITY BLVD. AND +/- 30 FT EAST OF C/L OF HEATHER GLEN PUBLISHED ELEVATION = 53.118 FEET (NAVD88)
- THE SURVEYOR HAS NOT ABSTRACTED THE LANDS SHOWN HEREON FOR EASEMENTS AND/OR RIGHT-OF-WAY RECORDS. THIS SURVEY WAS PREPARED WITHOUT THE BENEFIT OF A TITLE REPORT.
- THE LOCATION OF UNDERGROUND UTILITY LINES SHOWN HEREON WERE DETERMINED BY A COMBINATION OF PHYSICAL MARKING MADE BY THE UTILITY COMPANIES IN RESPONSE TO CALL SUNSHINE LOCATE REQUEST, TICKET NUMBER 271206813, FIELD MARKINGS BY BARNES, FERLAND AND ASSOCIATES, INC. AND BY EXAMINATION OF SURFACE APPURTENANCES OF SAID UTILITIES. NO UNDERGROUND INSTALLATIONS OR IMPROVEMENTS HAVE BEEN LOCATED EXCEPT AS SHOWN.
- ALL RECORDING REFERENCES SHOWN ON THIS SURVEY REFER TO THE PUBLIC RECORDS OF ORANGE COUNTY, FLORIDA, UNLESS OTHERWISE NOTED.
- UNLESS IT BEARS THE SIGNATURE AND THE ORIGINAL RAISED SEAL OF A FLORIDA LICENSED SURVEYOR AND MAPPER THIS DRAWING, SKETCH, PLAT, OR MAP IS FOR INFORMATIONAL PURPOSES ONLY AND IS NOT VALID.
- ACCORDING TO THE FLOOD INSURANCE RATE MAP (FIRM), DATED SEPTEMBER 25, 2009 THE SURVEY LIMITS SHOWN HEREON APPEARS TO LIE IN FLOOD ZONE "X", AREAS DETERMINED TO BE OUTSIDE THE 0.2% ANNUAL CHANCE FLOODPLAIN, AS LOCATED ON COMMUNITY PANEL NO. 120179-0280-F, MAP NUMBER 12095C0280F, FLOOD ZONE "AE" (BASE FLOOD ELEVATION OF 47 FEET, NORTH AMERICAN VERTICAL DATUM OF 1988, IS SHOWN HEREON. FOR REFERENCE PURPOSES ONLY.

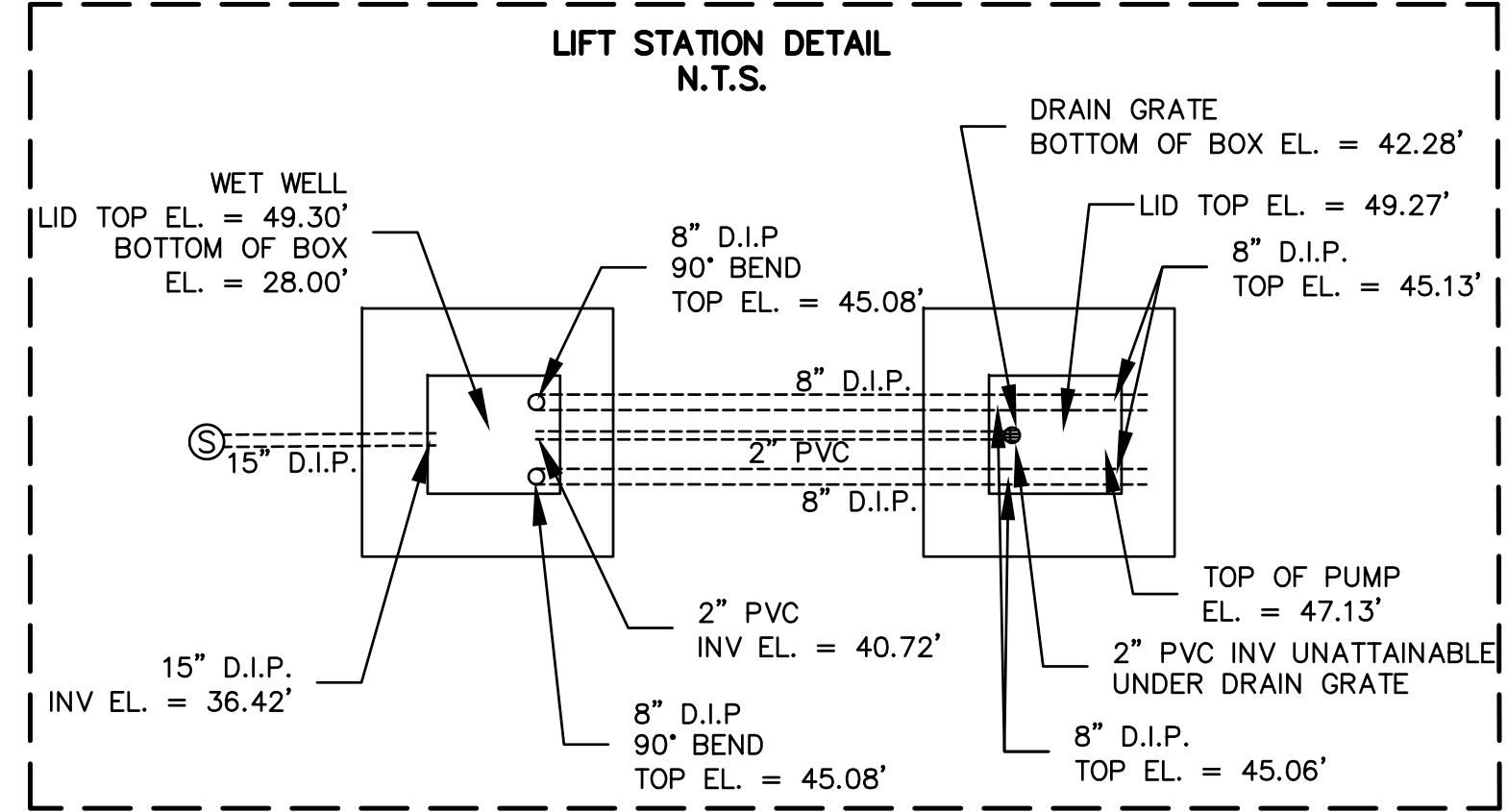

LEGEND & ABBREVIATIONS

- R/W = RIGHT OF WAY
- PVC = POLYVINYL CHLORIDE
- IR = IRON ROD
- IRC = IRON ROD & CAP
- CM = CONCRETE MONUMENT
- N&D = NAIL AND DISK
- ID = IDENTIFICATION
- INV = INVERT
- EL. = ELEVATION
- ORB = OFFICIAL RECORDS BOOK
- PB = PLAT BOOK
- PG. = PAGE
- PGS. = PAGES
- FND = FOUND
- CLF = CHAIN LINK FENCE
- ARV = AIR RELEASE VALVE
- D.I.P. = DUCTILE IRON PIPE
- BFP = BACK FLOW PREVENTER
- TOP = TOP OF BANK
- TOE = BOTTOM OF BANK
- CONC = CONCRETE
- N. = NORTHING
- E. = EASTING
- (F) = FIELD
- (P) = PLAT
- (C) = CALCULATED
- SEC. = SECTION
- TWP. = TOWNSHIP
- RGE. = RANGE
- NAVD88 = NORTH AMERICAN VERTICAL DATUM OF 1988
- W/ = WITH
- E/P = EDGE OF PAVEMENT
- S/C = SERVICE CABINET
- EM = ELECTRIC METER
- FAUCET
- BE = BURIED ELECTRIC
- FOC = BURIED FIBER OPTIC CABLE
- FM = FORCE MAIN
- OE = OVERHEAD ELECTRIC
- SE = SPOT ELEVATION
- PP = POWER POLE W/ TRANSFORMER
- PO = POWER POLE
- WPB = WIRE PULL BOX
- SIGN
- GA = GUY ANCHOR
- MP = METAL POST
- ENL = END NOT LOCATED

SUMMER WOODS
PLAT BOOK 17, PAGE 70

SANITARY MANHOLE
TOP = 48.29'
NE INV = 39.20'
SW INV = 39.15'

SITE BENCHMARK 2
SET 4"x4" CM W/ NAIL & DISK
"REFERENCE LB 6556"
EL. = 47.42'(NAVD88)
84.38' S, 16.16' W OF
SOUTHWEST PROPERTY CORNER
NOT SHOWN TO SCALE

FND 4"x4" CM W/ N&D
STAMPED "PRM 3970"
N: 1549822.85
E: 583237.57

PREPARED FOR

ORANGE COUNTY UTILITIES
BARNES, FERLAND AND ASSOCIATES, INC.

SURVEYOR'S CERTIFICATION

I HEREBY CERTIFY THAT A SURVEY OF THE PROPERTY SHOWN HEREON WAS MADE UNDER MY SUPERVISION AND THAT THIS SURVEY WAS PERFORMED IN ACCORDANCE WITH THE MINIMUM TECHNICAL STANDARDS AS SET FORTH BY THE FLORIDA BOARD OF PROFESSIONAL SURVEYORS AND MAPPERS, CHAPTER 5J-17, FLORIDA ADMINISTRATIVE CODE, PURSUANT TO SECTION 472.027, FLORIDA STATUTES AND THAT THE SKETCH HEREON IS A TRUE AND ACCURATE REPRESENTATION THEREOF TO THE BEST OF MY KNOWLEDGE AND BELIEF. SUBJECT TO NOTES AND NOTATIONS SHOWN

THIS DAY OF 20

H. Paul deVivero, Professional Land Surveyor No. 4990
Land Surveyor Business License No. 6556
VALID ONLY WITH SIGNATURE AND EMBOSSED SEAL

		DRAWN BY: DPW CHECKED BY: RHJ/IMS		
		DATE OF FIELD SURVEY: OCTOBER 29, 2012 FIELD BOOK NUMBER: 18-06; PAGES 24-43 SEC. 9, TWP. 22 S., RGE. 31 E. ORANGE COUNTY, FLORIDA		
No.	DATE	REVISION	DATE	SCALE
			OCTOBER 30, 2012	1" = 10'
			PROJECT No.	SHEET
			B18-14	OF 1

APPENDIX G

ORANGE COUNTY UTILITIES

DEWATERING DISCHARGE OFF-SITE

- **Orange County Environmental Protection Division Work Instruction**
- **Generic Permit for the Discharge of Produced Ground Water From any Non-Contaminated Site Activity**
- **FDEP Notice of New Method for Mercury Testing**
- **Memo – EPA - Analytical Methods for Mercury in NPDES Permits**

STATE OF FLORIDA

DEPARTMENT OF ENVIRONMENTAL PROTECTION

GENERIC PERMIT

FOR THE

DISCHARGE OF PRODUCED GROUND WATER

FROM ANY NON-CONTAMINATED SITE ACTIVITY

Generic Permit for the Discharge of Produced Ground Water from any Non-Contaminated Site Activity

(1) The facility is authorized to discharge produced ground water from any non-contaminated site activity which discharges by a point source to surface waters of the State, as defined in Chapter 62-620, F.A.C., only if the reported values for the parameters listed in Table 1 do not exceed any of the listed screening values. Before discharge of produced ground water can occur from such sites, analytical tests on samples of the proposed untreated discharge water shall be performed to determine if contamination exists.

(2) Minimum reporting requirements for all produced ground water dischargers. The effluent shall be sampled before the commencement of discharge, again within thirty (30) days after commencement of discharge, and then once every six (6) months for the life of the project to maintain continued coverage under this generic permit. Samples taken in compliance with the provisions of this permit shall be taken prior to actual discharge or mixing with the receiving waters. The effluent shall be sampled for the parameters listed in Table 1.

Table 1

Parameter	Screening Values for Discharges into:	
	Fresh Waters	Coastal Waters
Total Organic Carbon (TOC)	10.0 mg/l	10.0 mg/l
pH, standard units	6.0-8.5	6.5-8.5
Total Recoverable Mercury	0.012 µg/l	0.025 µg/l
Total Recoverable Cadmium	9.3 µg/l	9.3 µg/l
Total Recoverable Copper	2.9 µg/l	2.9 µg/l
Total Recoverable Lead	0.03 mg/l	5.6 µg/l
Total Recoverable Zinc	86.0 µg/l	86.0 µg/l
Total Recoverable Chromium (Hex.)	11.0 µg/l	50.0 µg/l
Benzene	1.0 µg/l	1.0 µg/l
Naphthalene	100.0 µg/l	100.0 µg/l

(3) If any of the analytical test results exceed the screening values listed in Table 1, except TOC, the discharge is not authorized by this permit.

(a) For initial TOC values that exceed the screening values listed in Table 1, which may be caused by naturally-occurring, high molecular weight organic compounds, the permittee may request to be exempted from the TOC requirement. To request this exemption, the permittee shall submit additional information with a Notice of Intent (NOI),

described below, which describes the method used to determine that these compounds are naturally occurring. The Department shall grant the exemption if the permittee affirmatively demonstrates that the TOC values are caused by naturally-occurring, high molecular weight organic compounds.

(b) The NOI shall be submitted to the appropriate Department district office thirty (30) days prior to discharge, and contain the following information:

1. the name and address of the person that the permit coverage will be issued to;
2. the name and address of the facility, including county location;
3. any applicable individual wastewater permit number(s);
4. a map showing the facility and discharge location (including latitude and longitude);
5. the name of the receiving water; and
6. the additional information required by paragraph (3)(a) of this permit.

(c) Discharge shall not commence until notification of coverage is received from the Department.

(4) For fresh waters and coastal waters, the pH of the effluent shall not be lowered to less than 6.0 units for fresh waters, or less than 6.5 units for coastal waters, or raised above 8.5 units, unless the permittee submits natural background data confirming a natural background pH outside of this range. If natural background of the receiving water is determined to be less than 6.0 units for fresh waters, or less than 6.5 units in coastal waters, the pH shall not vary below natural background or vary more than one (1) unit above natural background for fresh and coastal waters. If natural background of the receiving water is determined to be higher than 8.5 units, the pH shall not vary above natural background or vary more than one (1) unit below natural background of fresh and coastal waters. The permittee shall include the natural background pH of the receiving waters with the results of the analyses required under paragraph (2) of this permit. For purposes of this section only, fresh waters are those having a chloride concentration of less than 1500 mg/l, and coastal waters are those having a chloride concentration equal to or greater than 1500 mg/l.

(5) In accordance with Rule 62-302.500(1)(a-c), F.A.C., the discharge shall at all times be free from floating solids, visible foam, turbidity, or visible oil in such amounts as to form nuisances on surface waters.

(6) If contamination exists, as indicated by the results of the analytical tests required by paragraph (2), the discharge cannot be covered by this generic permit. The facility shall apply for an individual wastewater permit at least ninety (90) days prior to the date discharge to surface waters of the State is expected, or, if applicable, the facility may seek coverage under any other applicable Department generic permit. No discharge is permissible without an effective permit.

(7) If the analytical tests required by paragraph (2) reveal that no contamination exists from any source, the facility can begin discharge immediately and is covered by this permit without having to submit an NOI request for coverage to the Department. A short summary of the proposed activity and copy of the analytical tests shall be sent to the applicable Department district office within one (1) week after discharge begins. These analytical tests shall be kept on site during discharge and made available to the Department if requested. Additionally, no Discharge Monitoring Report forms are required to be submitted to the Department.

(8) All of the general conditions listed in Rule 62-621.250, F.A.C., are applicable to this generic permit.

(9) There are no annual fees associated with the use of this generic permit.



Department of Environmental Protection

Notice of New Method for Mercury Testing

New Method for Mercury Testing Has Been Approved

In accordance with Rule 62-620.610, Florida Administrative Code (F.A.C.), all sampling and monitoring data, required to be reported to the Department, shall be collected and analyzed in accordance with Rule 62-4.246, Chapters 62-160 and 62-601, F.A.C., and 40 CFR 136, as appropriate. Effective August 25, 2003, Chapter 62-620, F.A.C., was revised to adopt, and incorporate by reference, various sections of Title 40 of the Code of Federal Regulations revised as of July 1, 2003, including the revised 40 CFR 136. The revised 40 CFR 136 includes a new method for low-level mercury analysis, EPA Method 1631(Revision E), Mercury in Water by Oxidation, Purge and Trap, and Cold Vapor Atomic Fluorescence Spectrometry (Method 1631E).

Who is Required to Use Method 1631E?

Applicants for a wastewater facility permit and wastewater facility permittees are now required to use the low-level mercury Method 1631E when reporting results associated with water quality standards (WQSs) below 0.2 micrograms per liter (ug/L). The following facilities are now required to use Method 1631E for all **effluent samples**:

- Facilities discharging to Class I and Class II surface waters, including wetlands.
- Facilities discharging to Class III Marine or Fresh surface waters, including wetlands.
- Facilities with Water Quality Based Effluent Limits (WQBELs), or any other limit for mercury specified in a permit, below 0.2 ug/L.

This includes effluent samples collected for any of the following requirements:

- Monitoring specified in Section I, *Reclaimed Water and Effluent Limitations and Monitoring*, section of permits.
- Monitoring performed under Section 3.A. of *Wastewater Permit Application Form 2A For Domestic Wastewater Facilities*; Part VII.C. of *Application to Discharge Process Wastewater from New or Existing Industrial Wastewater Facilities to Surface Water - Form 2CS*; or Part V.C. of *Application to Discharge Process Wastewater from New or Existing Industrial Wastewater Facilities to Ground Water - Form 2CG*.
- Priority pollutant scans performed in accordance with pretreatment program annual report requirements.
- Monitoring performed for the development or re-evaluation of local discharge limitations.
- Monitoring required in Table 4 of the Generic Permit for Discharges from Petroleum Contaminated Sites and Table 1 of the Generic Permit for the Discharge of Produced Ground Water from any Non-Contaminated Site Activity.

The low-level mercury method provides, for the first time, the ability to assess compliance with mercury water quality standards (WQSs) below 0.2 ug/L. Your permit requires that surface water discharges shall be analyzed using a sufficiently sensitive method in accordance with 40 CFR 136. *Wastewater Permit Application Forms 2A, 2CS, and 2CG* require effluent testing be conducted using methods that are able to detect pollutants at levels adequate to meet WQSs and to provide reasonable assurance that the WQSs will not be violated in the future.

Additionally, in order to develop technically and legally defensible local discharge limitations for domestic wastewater facilities that have pretreatment programs, Method 1631E must be used to provide data that clearly establishes the basis for any calculated mercury limitations. Note, regarding local discharge limitations, the requirement to use Method 1631E may be expanded to other locations in the collection and treatment system on a case-by-case basis depending on the initial results from effluent analysis using Method 1631E.

Mercury Laboratory Analysis

Method 1631E has a minimum level of quantitation of 0.0005 ug/L, or 0.5 nanograms per liter (ng/L), which is 400-times more sensitive than Method 245.1 ("Manual Cold Vapor Technique"). Due to the sensitivity of Method 1631E, the results are typically measured in parts per trillion (ng/L) rather than in parts per billion (µg/L). The Department is currently evaluating Method 1631E to determine target method detection limits (MDLs) and target practical quantification limits (PQLs). Until target MDLs and PQLs are incorporated into Rule 62-4.246(4), the laboratory analysis is expected to achieve MDLs close to, or below, 1 ng/L. All laboratory analysis must be done by a NELAP accredited laboratory with current certification by Florida Department of Health for Method 1631E.

Mercury Clean Sampling Techniques

Clean sample handling techniques should be used when collecting samples for low-level mercury analysis to preclude false positives arising from sample collection, handling, or analysis. Sample collection methods should be consistent with *DEP-SOP-001/01: FS 8200 Clean Sampling For Ultratrace Metals in Surface Waters* and *EPA Method 1669: Sampling Ambient Water for Trace Metals at EPA Water Quality Criteria Levels* (EPA-821-R-96-011). Because FS 8200 and Method 1669 are performance-based procedures, sample collection personnel may modify these procedures or eliminate steps if the modification does not lead to unacceptable contamination of samples or blanks. Any modifications should be thoroughly evaluated and demonstrated to be effective before field samples are collected. This may be accomplished through documentation of uncontaminated samples, equipment blanks and/or other quality control samples.

Note, discrete and composite samplers have been found to contaminate samples with mercury at the ng/L level. Therefore, grab samples are permissible when using Method 1631E. However, grab samples must be representative of the wastewater discharge and a field blank should be collected along with the sample.

In order for a permittee to justify a claim that any reported mercury is due to outside contamination, a blank must have been collected. For this reason, permittees should consider collecting at least one blank at each site for each day a sample is collected. If more than one sample is collected in a day, at least one blank for each 10 samples collected on that day should also be collected. The blank may either be an equipment blank or a field blank. Once a permittee demonstrates the ability to collect samples from a given site using an established procedure that prevents contamination, the permittee may choose to decrease the number of blanks being taken. Specific definitions and procedures for collecting blanks are found in DEP SOP FQ 1000.

Field blanks should be collected only if no equipment other than the sample container is used to collect samples. If the sampling procedure involves the use of additional equipment, such as a peristaltic pump and pump tubing, equipment blanks should be collected. All blanks are subject to the same preservation, digestion, and analysis protocols as regular samples and should have a concentration at least five times lower than the sample concentration. The permittee may not subtract field blank concentrations when reporting sample results.

Sample-collection, preservation, and shipping requirements should be discussed with contract laboratories to ensure the requirements of Method 1631E are met.

Additional Assistance and Information

For additional information on Method 1631:
www.epa.gov/waterscience/methods/1631.html

Please refer questions concerning sample collection to:
Silky Labic: 850-245-8066
Silky.Labic@dep.state.fl.us

Additional information concerning NELAP certified laboratories can be obtained from:
Department of Health Bureau of Laboratories
P.O. Box 210 Jacksonville, FL 32231
(904) 791-1599 (voice)(904) 791-1591 (fax)
[ftp.dep.state.fl.us/pub/labs/assessment/doh/accredited.pdf](ftp://ftp.dep.state.fl.us/pub/labs/assessment/doh/accredited.pdf)



UNITED STATES ENVIRONMENTAL PROTECTION AGENCY
WASHINGTON, D.C. 20460

OFFICE OF
WATER

signed: August 23, 2007

MEMORANDUM

SUBJECT: Analytical Methods for Mercury in National Pollutant Discharge Elimination System (NPDES) Permits

FROM: James A. Hanlon, Director
Office of Wastewater Management

TO: Water Division Directors, Regions 1 - 10

The purpose of this memorandum is to inform you of EPA's March 12, 2007, approval of Method 245.7 for measurement of mercury and modified versions of approved analytical methods for mercury as well as the impact of their approval on the NPDES permitting process. While several different methods are currently approved under 40 CFR Part 136 for the analysis of mercury, some of these methods have much greater sensitivities and lower quantitation levels than others. This memorandum clarifies and explains that, in light of existing regulatory requirements for NPDES permitting,¹ only the most sensitive methods such as Methods 1631E and 245.7 are appropriate in most instances for use in deciding whether to set a permit limitation for mercury and for sampling and analysis of mercury pursuant to the monitoring requirements within a permit.

BACKGROUND

Section 301 of the Clean Water Act (CWA) requires NPDES permits to include effluent limitations that are as stringent as necessary to meet water quality standards. Thus, under the Act and EPA regulations, each permit must include, as necessary, requirements in addition to or more stringent than technology-based effluent limitations established under section 301 of the CWA in order to achieve water quality standards. 40 C.F.R. § 122.44(d)(1). The regulations require limitations to control all pollutants that the NPDES program director determines are or may be discharged at a level that "will cause, have the reasonable potential to cause, or contribute to an excursion above any state water quality standard," including both narrative and

¹ This memorandum is based on existing legal requirements and authorities. It does not impose any new, legally binding requirements on EPA, states, or the regulated community.

numeric criteria, 40 C.F.R. § 122.44(d)(1)(i). If the program director determines that a discharge has the reasonable potential to cause or contribute to such an excursion, the permit must contain water quality-based effluent limitations for the pollutant, 40 C.F.R. § 122.44(d)(1)(iii). Thus, a prospective permittee may need to measure various pollutants in its effluent at two stages: first, at the permit application stage so that the program director can determine whether “reasonable potential” exists and establish appropriate permit limits; and second, where a permit limit has been established, to meet the monitoring requirements within the permit. The following discussion explains which analytical methods permit applicants and permittees should use to make these measurements when mercury is the pollutant at issue.

Approved Analytical Methods

Measurements included on NPDES permit applications and on reports required to be submitted under the permit must generally be made using analytical methods approved by EPA under 40 CFR Part 136. See 40 CFR 136.1, 136.4, 136.5, 122.21(g)(7), and 122.41(j). For mercury, there are three methods commonly used in the NPDES program that EPA has approved under Part 136: Method 245.1, Method 245.2, and Method 1631E. Methods 245.1 and 245.2 were approved by EPA in 1974 and can achieve measurement of mercury down to 200 parts per trillion (ppt). Additionally, EPA approved Method 1631 Revision E in 2002. Method 1631E has a quantitation level of 0.5 ppt, making it 400 times more sensitive than Methods 245.1 and 245.2. In fact, the sensitivity of Methods 245.1 and 245.2 are well above the water quality criteria now adopted in most states (as well as the criteria included by EPA in the Final Water Quality Guidance for the Great Lakes System) for the protection of aquatic life and human health, which generally fall in the range of 1 to 50 ppt.² In contrast, Method 1631E, with a quantitation level of 0.5 ppt, does support the measurement of mercury at these low levels.

In addition to Methods 245.1, 245.2, and 1631E listed above, EPA approved Method 245.7 as well as modified versions of other EPA-approved methods on March 12, 2007. See 72 FR 11200. Method 245.7 has a quantitation level of 5.0 ppt, making it 40 times more sensitive than Methods 245.1 and 245.2. Additionally, modified versions of EPA-approved methods may also be used for the measurement of mercury. Methods approved under Part 136, such as 245.1 and 245.2, may be modified to achieve lower quantitation levels than can be achieved by the method as written.³ Modifications to an EPA-approved method for mercury that meet the method

² Many states have adopted mercury water quality criteria of 12 ppt for protection of aquatic life and 50 ppt for the protection of human health, and for discharges to the Great Lakes Basin, the applicable water quality criteria for mercury are 1.3 ppt for the protection of wildlife and 1.8 ppt for the protection of human health. In 2001, EPA issued new recommended water quality criteria guidance for the protection of human health. This new guidance recommends adoption of a methylmercury water quality criterion of 0.3 milligrams of methylmercury per kilogram (mg/kg) in fish tissue. EPA is currently developing implementation guidance to assist states in implementing the criterion, and *Draft Guidance for Implementing the January 2001 Methylmercury Water Quality Criterion* (EPA-823-B-04-001) was released for public comment in August 2006.

³ Examples of such modification may include changes in the sample preparation digestion procedures such as the use of reagents similar in properties to ones used in the approved method, changes in the equipment operating parameters such as the use of an alternate more sensitive wavelength, adjusting the sample volume to optimize method performance, and changes in the calibration ranges (provided that the modified range covers any relevant regulatory limit).

performance requirements of Part 136.6 are considered to be approved methods and require no further EPA approval. See 72 FR 11239-40 (March 12, 2007). For analytical method modifications that do not fall within the flexibility of Part 136.6, the modified methods may be approved under the alternate test procedure program as defined by Parts 136.4 and 136.5.

ACTIONS RESULTING FROM THE MARCH 12, 2007, RULEMAKING

To implement the March 12, 2007, rule, the Office of Wastewater Management (OWM) provides the following guidance:

Monitoring Data Submitted as Part of NPDES Permit Applications

As noted, most states have adopted water quality criteria for the protection of aquatic life and human health that fall in the range of 1 to 50 ppt, and Methods 245.1 and 245.2, as written, do not detect or quantify mercury in this range. A "did not detect" result using Method 245.1 or Method 245.2 would show only that mercury levels are below 200 ppt but would not establish that they are at or below the applicable water quality criterion. Therefore, when a permit writer receives a permit application reporting mercury data analyzed with Method 245.1 or Method 245.2 as "did not detect" results, the permit writer in reality may lack the information needed to make a "reasonable potential" determination. In contrast, Method 1631E is able to detect and quantify mercury concentrations at these low levels.

EPA therefore expects, in general, that all facilities with the potential to discharge mercury will provide with their NPDES permit applications monitoring data for mercury using Method 1631E or another sufficiently sensitive EPA-approved method. For purposes of permit applications, a method for mercury is "sufficiently sensitive" when (1) its method quantitation level is at or below the level of the applicable water quality criterion for mercury or (2) its method quantitation level is above the applicable water quality criterion, but the amount of mercury in a facility's discharge is high enough that the method detects and quantifies the level of mercury in the discharge.⁴ Accordingly, EPA strongly recommends that the permitting authority determine that a permit application that lacks effluent data analyzed with a sufficiently sensitive EPA-approved method such as Method 1631E is incomplete unless and until the facility supplements the original application with data analyzed with such a method. See 40 CFR 122.21(e) (a permit application is determined to be complete at the discretion of the permitting authority) and 40 CFR 122.21(g)(13) (the applicant shall provide to the Director, upon request, such other information as the Director may reasonably require to assess the discharge). Such data would allow the permitting authority to characterize the effluent to determine whether the discharge causes, has the reasonable potential to cause, or contributes to an excursion of state water quality standards for mercury and would consequently allow the permitting authority to determine whether a water quality-based effluent limit for mercury is necessary in the permit.

⁴ To illustrate the latter, if the water quality criterion for mercury in a particular state is 2.0 ppt, Method 245.7 (with a quantitation level of 5.0 ppt) would be sufficiently sensitive where it reveals that the level of mercury in a facility's discharge is 5.0 ppt or greater. In contrast, Method 245.7 would not be sufficiently sensitive if it resulted in a level of non-detect for that discharge because it could not be known whether mercury existed in the discharge at a level between 2.0 and 5.0 (less than the quantitation level but exceeding the water quality criterion).

Monitoring Requirements in Permits

Where a permit authority establishes a permit limit for mercury, it also needs to consider specifying an analytical method that the permittee must use to monitor for mercury during the term of the permit. Methods 245.1 and 245.2, as written, are not likely to be sensitive enough to detect or quantify the concentration of mercury in the discharge at a level that matches the limitation for mercury in the permit. EPA therefore expects the permitting authority to require the use of a sufficiently sensitive EPA-approved method for monitoring under the permit in order to ensure that the sampling and measurements required are "representative of the monitored activity" (as required by 40 CFR 122.41(j)(1)). For purposes of monitoring under a permit, a method for mercury is "sufficiently sensitive" when (1) its method quantitation level is at or below the level of the mercury limit established in the permit or (2) its method quantitation level is above the mercury limit in the permit, but the amount of mercury in a facility's discharge is high enough that the method detects and quantifies the level of mercury in the discharge.⁵

EPA Permit Review and Objection to State Issued Permits

For NPDES-authorized states, EPA regions are expected to review state permits and should strongly consider objecting to permits that are issued based on analytical data collected and analyzed using an EPA-approved method that is not sufficiently sensitive or that do not require use of a sufficiently sensitive EPA-approved method for monitoring when the permit includes a limit for mercury. OWM is expecting to undertake a permit quality review of a small representative number of permits with respect to mercury limitations and other conditions.

If you have questions concerning the content of this memorandum, please contact Linda Boornazian, Director of the Water Permits Division, at 202-564-0221 or have your staff contact Marcus Zobrist of the State and Regional Branch at 202-564-8311 or zobrist.marcus@epa.gov.

cc: NPDES Branch Chiefs Regions 1 - 10

⁵ See footnote 4.

**ORANGE COUNTY ENVIRONMENTAL PROTECTION DIVISION
WORK INSTRUCTION**

Title: Dewatering Permitting and Approvals Work Instruction
Number: EPD-WI-2000-04

Effective Date: 10/04/2011 Revision: 1
Renewal Date: 10/04/2014 Revision Date: 10/04/2011
Approved By: Elizabeth R. Johnson, Environmental Programs Administrator

Purpose: The purpose of this work instruction is to provide guidance regarding the approvals required to initiate construction related dewatering in unincorporated Orange County

I. Procedure

County Offices:

Orange County Public Works

For proposed dewatering discharges to the Orange County Municipal Separate Storm Sewer System (MS4), contact Orange County Development Engineering prior to commencement of dewatering. OC Public Works Contact: Miguel Tamayo, 407-836-7914.

Orange County Utilities (OCU)

If the groundwater discharge testing indicates groundwater quality parameter exceedences, the discharge may be allowed to enter into the Orange County sanitary system. Coordinate with OCU. If OCU can accept the discharge, a County Industrial Wastewater Discharge Permit (IWD) will be required. Per Florida Department of Environmental Protection (FDEP), no FDEP dewatering permitting is required if an IWD is received.

Contact: Susanna Littell, OCU/Water Reclamation, 407-254-7710 (Industrial Wastewater Discharge Permits)

Contact: Laura Woodbury, P.E., OCU/Development Engineering, 407-254-9928.

Rules/Permits:

- Chapter 37 Article XX. Addresses industrial waste pretreatment and permitting.
- Industrial Wastewater Discharge (IWD) Permit. Required prior to discharge to the wastewater system.
- OCU Development Engineering Connection Requirements. OCU Development Engineering reviews and approves plans for groundwater dewatering and remediation projects when discharge will be to the OCU sanitary sewer system.

EPD-WI-2000-04	Effective Date: 10/04/2011
The only official copy of this document is on the EPD intranet.	Page 1 of 3

**ORANGE COUNTY ENVIRONMENTAL PROTECTION DIVISION
WORK INSTRUCTION**

State Agencies:

Florida Department of Environmental Protection (FDEP)

For dewatering that is discharged offsite, sampling/analytical work is required prior to dewatering to determine if the proposed activity can be permitted under one of the generic dewatering permits.

FDEP Contacts: Ali Kazi, 407-897-4149; Randall Cunningham, 407-897-4152.

Rules/Permits:

- Generic Permit for Discharges from Petroleum Contaminated Sites (62-621.300(1)).
- Generic Permit for the Discharge of Produced Groundwater from any Non-Contaminated Site Activity (62-621.300(2)).
- Permit for all Other Contaminated Sites (62-04; 62-302; 62-620 & 62-660).

Water Management Districts:

St. Johns River Water Management District

Contact: Richard Kimmel, 407-659-4849.

Rules/Permits:

- No permit ("No Notice").
- Noticed General Permit for Short-term Construction Dewatering.
- Individual and Standard General Consumptive Use Permit.

South Florida Water Management District

Contact: Mario Cabana, 407-858-6100, ext. 3816.

Rules/Permits:

- "No-Notice" Short-Term Dewatering Permits.
- Dewatering General Water Use Permits.
- Long-term Dewatering Individual Permits.

For dewatering activities located in the City of Orlando contact Lisa Lotti at 407-246-2037.

II. Scope

This procedure applies to construction sites within unincorporated Orange County.

Definitions:

Off-site: For the purposes of this Work Instruction, off-site means property not under control of the owner/applicant or (discharging to) the municipal separate storm sewer system or waters of the County.

EPD-WI-2000-04	Effective Date: 10/04/2011
The only official copy of this document is on the EPD intranet.	Page 2 of 3

**ORANGE COUNTY ENVIRONMENTAL PROTECTION DIVISION
WORK INSTRUCTION**

Related Documents:

Florida Department of Environmental Protection's Construction Generic Permit

History of Revisions:

Revision No.	Revision Date	Summary of Revisions
0	06/06/2011	Original
1	10/04/2011	Update contact information