

**ORANGE COUNTY UTILITIES
MASTER WASTEWATER PUMP STATIONS IMPROVEMENTS
DR. PHILLIPS PUMP STATION #3151 - REHABILITATION**

**DOCUMENTS
AND
SPECIFICATIONS**

BID ISSUE

**Prepared By:
BLACK & VEATCH CORPORATION
Orlando, FL 32801**

**B&V Project No. 147929
October 2012**

THIS PAGE LEFT BLANK INTENTIONALLY

Orange County Utilities
Master Wastewater Pump Stations
Dr. Phillips Pump Station #3151 - Rehabilitation

TABLE OF CONTENTS

Subject	Pages
SPECIFICATIONS	
DIVISION 1 – GENERAL REQUIREMENTS	
01015 Project Requirements	1 : 9
01025 Measurement and Payment	1 : 2
01060 Permits and Regulatory Requirements	1 : 2
01070 Abbreviations of Terms and Organizations	1 : 4
01300 Submittals	1 : 5
01310 Construction Scheduling	1 : 2
01320 Construction Progress Documentation	1 : 1
01380 Construction Photographs	1 : 1
01400 Quality Control	1 : 2
01500 Temporary Facilities	1 : 8
01516 Collection System Bypass	1 : 3
01610 General Equipment Stipulations	1 : 4
01612 Shipping	1 : 1
01614 Handling and Storage	1 : 2
01620 Equipment Schedule	1 : 1
01630 Pipeline Schedule	1 : 2
01650 Startup Requirements	1 : 3
01720 Project Record Documents & Samples	1 : 10
DIVISION 2 – SITEWORK	
02050 Equipment, Piping & Materials Demolition	1 : 4
02200 Earthwork	1 : 12
02202 Trenching and Backfilling	1 : 13
02605 Sewer Manholes & Wetwells	1 : 6

Subject	Pages
02628 Polyvinyl Chloride (PVC) Sewer Pipe	1 : 2
02630 Polyvinyl Chloride (PVC) Pressure Pipe	1 : 4
02630- S01 Polyvinyl Chloride (PVC) Pressure Pipe Schedule	1 : 1
02675 Cleaning and Disinfection of Potable Water Lines	1 : 4
02702 Sewer Pipe Installation and Testing	1 : 4
02704 Pipeline Pressure and Leakage Testing	1 : 3
02810 Sodding	1 : 5
02825 Ornamental Swing Gates	1 : 3
 DIVISION 3 – CONCRETE	
03301 Concrete	1 : 10
03430 Structural Precast Concrete	1 : 8
03600 Grout	1 : 2
03700 Concrete Repair	1 : 6
03710 Concrete Crack Repair	1 : 4
 DIVISION 4 – MASONRY	
04200 Building Masonry	1 : 11
 DIVISION 5 – METALS	
05550 Anchorage In Concrete and Masonry	1 : 5
 DIVISION 6 – WOOD AND PLASTICS – Not Used	
 DIVISION 7 – THERMAL AND MOISTURE PROTECTION	
07185 Masonry Water Repellant Coating	1 : 2
07532 Single-Ply Roofing, Fully Adhered	1 : 6
07600 Sheet Metal	1 : 3
07900 Caulking	1 : 3

Subject	Pages
DIVISION 8 – DOORS AND WINDOWS	
08115 Fiberglass Reinforced Plastic Doors and Frames	1 : 4
08305 Access Hatches	1 : 2
08700 Finish Hardware	1 : 4
DIVISION 9 – FINISHES	
09940 Protective Coatings	1 : 15
DIVISION 10 – SPECIALTIES	
10990 Miscellaneous Specialties	1 : 2
DIVISION 11 – EQUIPMENT	
11060 Equipment Installation	1 : 4
11150 Submersible Pumps	1 : 9
11291 Stainless Steel Sluice Gates	1 : 7
11354 Carbon Adsorption Units	1 : 12
11355 Biotrickling Filter Systems	1 : 20
11356 Odor Control Fans	1 : 12
11357 Odor Control Dampers	1 : 5
11390 Adjusting and Balancing Odor Control Systems	1 : 4
11910 Engine-Generators	1 : 15
11911 Removal Of Existing Engine-Generator	1 : 1
DIVISION 12 – FURNISHINGS – Not Used	
DIVISION 13 – SPECIAL CONSTRUCTION	
13214 Aboveground Fuel Storage Tanks	1 : 10
13500 Instrumentation and Control System	1 : 15
13500A Instrument Device Schedule	1 : 2
13530 Programmable Logic Controllers	1 : 7
13530A Appendix PLC Input/Output Listing	1 : 3

Subject	Pages
13540 Radio Equipment	1 : 5
13550 Software Control Block Descriptions	1 : 7
13561 Panel Mounted Instruments	1 : 4
13562 Flow Instruments	1 : 4
13563 Pressure and Level Instruments	1 : 5
13565 Miscellaneous Instruments	1 : 3
13570 Panels, Consoles, and Appurtenances	1 : 4
13570- S02 Wall Mounted Cabinet Schedule	1 : 1
13990 Removal of Aboveground Fuel Storage Tanks	1 : 3
DIVISION 14 – CONVEYING SYSTEMS – Not Used	
DIVISION 15 – MECHANICAL	
15010 Valve Installation	1 : 3
15020 Miscellaneous Piping and Accessories Installation	1 : 11
15050 Basic Mechanical Building Systems Materials and Methods	1 : 6
15060 Miscellaneous Piping and Pipe Accessories	1 : 2
15061 Ductile Iron Pipe	1 : 15
15061- S01 Ductile Iron Pipe Schedule	1 : 1
15064 Stainless Steel Pipe, Tubing, and Accessories	1 : 4
15065 Miscellaneous Steel Pipe, Tubing, and Accessories	1 : 7
15066 Fiberglass Reinforced Plastic Pipe (Air Service)	1 : 7
15067 Miscellaneous Plastic Pipe, Tubing, and Accessories	1 : 4
15091 Miscellaneous Ball Valves	1 : 4
15093 Check Valves	1 : 4
15093- S01 Check Valves Schedule	1 : 2
15094 Backflow Preventers	1 : 2
15094- S01 Backflow Preventer Schedule	1 : 1
15102 Eccentric Plug Valves	1 : 5

Subject	Pages
15102- S01 Eccentric Plug Valves Schedule Manual Actuators	1 : 3
15104 Resilient-Seated Gate Valves	1 : 3
15108 Air Release Valves	1 : 2
15108- S01 Air Release Valves Schedule	1 : 2
15111 Gate Installation	1 : 3
15130 Pressure Gauges	1 : 2
15140 Pipe Supports	1 : 9
15180 Valve and Gate Actuators	1 : 10
15400 Plumbing	1 : 10
15500 Heating, Ventilating, and Air Conditioning	1 : 13
15990 Testing, Adjusting, and Balancing	1 : 5
 DIVISION 16 – ELECTRICAL	
16050 Electrical	1 : 25
16100 Electrical Equipment Installation	1 : 2
16150 Adjustable Frequency Drives	1 : 13
16220 General Purpose Induction Motors	1 : 7
16425 Switchboards	1 : 5
16491 Automatic Transfer Switch	1 : 7
16670 Lightning Protection Systems	1 : 3

FIGURES

Number	Title	Following Page
1-01300	Submittal Identification & Contractor's Approval Statement	01300-5
2-01300	Submittal Identification & Contractor's Approval Statement	01300-5
1-02200	Protective System Design Certificate	02200-12
1-02202	Embedments for Conduits	02202-13
2-02202	Protective System Design Certificate	02202-13
1-09940	Coating System Data Sheet	09940-15
2-09940	Coating System Data Sheet	09940-15
1-13500	Instrument Calibration Report	13500-15
1-15140(A)	Hangers and Supports	15140-9
1-15140(B)	Hangers and Supports	15140-9
1-16050	600 Volt, Single Conductor Lighting/Power Cable (600 1 XLP NONE XHHW-2)	16050-25
2-16050	600 Volt, Single Pair, Shielded Instrument Cable (600 SINGLE PAIR SH INSTR)	16050-25
3-16050	600 Volt, Single Triad, Shielded Instrument Cable (600 SINGLE TRIAD SH INSTR)	16050-25
4-16050	600 Volt, Multiple Pair and/or Triad, Shielded Instrument Cable (600 MULTI PAIRS TRIADS SH INSTR)	16050-25
5-16050	600 Volt, Multiconductor 14 AWG (2.5 mm ²) Control Cable (600 MULTI THHN THWN)	16050-25

Section 01015

PROJECT REQUIREMENTS

Section 01015 - PROJECT REQUIREMENTS - LIST OF SUBJECTS

1. GENERAL DESCRIPTION OF WORK
2. UNITS OF MEASUREMENT
3. WORK BY PUBLIC UTILITIES
4. OFFSITE STORAGE
5. APPROVED PRODUCTS, SUBSTITUTES AND “OR-EQUAL” ITEMS
6. PREPARATION FOR SHIPMENT
7. SALVAGE OF MATERIALS AND EQUIPMENT
8. LAND FOR CONSTRUCTION PURPOSES
9. EASEMENTS
 - 9.01. On Private Property
 - 9.02. Work Within Highway
10. OPERATION OF EXISTING FACILITIES
11. NOTICES TO OWNERS AND AUTHORITIES
12. LINES AND GRADES
13. CONNECTIONS TO EXISTING FACILITIES
14. UNFAVORABLE CONSTRUCTION CONDITIONS
15. CUTTING AND PATCHING
16. ASBESTOS REMOVAL
 - 16.01. Subcontractor's Qualifications
 - 16.02. Abatement Methods
17. CLEANING UP
18. APPLICABLE CODES

19. REFERENCE STANDARDS
20. PRECONSTRUCTION CONFERENCE
21. PROGRESS MEETINGS
22. SITE ADMINISTRATION

Section 01015

PROJECT REQUIREMENTS

1. GENERAL DESCRIPTION OF WORK. The Work to be performed under these Contract Documents is generally described as follows:

PS 3151 – Dr. Phillips/Days Inn

Demolish existing wetwell and equipment and replace with a new dual cast-in-place wetwell and splitter structure. Specific improvements will include:

1. New submersible variable speed pumps in a dual wetwell structure
2. New influent and force main piping
3. Discharge valves and flowmeter located above grade
4. New biofilter for odor control
5. New engine generator and fuel tank for emergency power
6. New electrical power equipment
7. New instrumentation systems
8. New variable speed drives in an air-conditioned, block electrical building
9. New perimeter block wall and gate

2. UNITS OF MEASUREMENT. Both inch-pound (English) and SI (metric) units of measurement are specified herein; the values expressed in inch-pound units shall govern.

3. WORK BY PUBLIC UTILITIES.

4. OFFSITE STORAGE. Offsite storage arrangements shall be approved by Owner for all materials and equipment not incorporated into the Work but included in Applications for Payment. Such offsite storage arrangements shall be presented in writing and shall afford adequate and satisfactory security and protection. Offsite storage facilities shall be accessible to Owner and Engineer.

5. APPROVED PRODUCTS, SUBSTITUTES AND "OR-EQUAL" ITEMS. Approved product materials and equipment manufacturers have been identified in the Specifications. If they are not listed, approved products listed in the Orange County Utilities Standards and Construction Specifications Manual shall be used. Whenever there is a conflict in the list of approved products listed in the Specifications and the current edition of Orange County Utilities Standards and Construction Specifications Manual, the more stringent of the two standards will apply. Whenever a material or article is specified or described by using the name of a proprietary product or the name of a particular manufacturer or vendor, the specified item shall be understood as establishing the type, function, and quality desired. Requests for review of equivalency will not be accepted from anyone except Contractor, and such requests will not be considered until after the Contract has been awarded. Other

manufacturers' products may be accepted, provided sufficient information is submitted to allow Engineer to determine that the products proposed are equivalent to those named and the product complies with Orange County List of Approved Products.. Such items shall be submitted for review by the procedure set forth in the Submittals section.

6. PREPARATION FOR SHIPMENT. All materials shall be suitably packaged to facilitate handling and protect against damage during transit and storage. Painted surfaces shall be protected against impact, abrasion, discoloration, and other damage. All painted surfaces which are damaged prior to acceptance of equipment shall be repainted to the satisfaction of Owner.

Each item, package, or bundle of material shall be tagged or marked as identified in the delivery schedule or on the Shop Drawings. Complete packing lists and bills of material shall be included with each shipment.

7. SALVAGE OF MATERIALS AND EQUIPMENT. Existing materials and equipment removed and not reused as a part of the Work shall become Contractor's property, except the items to be salvaged which shall remain Owner's property.

Contractor shall carefully remove, in a manner to prevent damage, all materials and equipment specified or indicated to be salvaged and reused or to remain the property of Owner. Contractor shall store and protect salvaged items specified or indicated to be reused in the Work.

Salvaged items not to be reused in the Work, but to remain Owner's property shall be delivered by Contractor in good condition to Owner at location indicated on the drawings.

Any items specified or indicated to be salvaged which are damaged in removal, storage, or handling through carelessness or improper procedures shall be replaced by Contractor in kind or with new items.

Contractor may furnish and install new items instead of those specified or indicated to be salvaged and reused, in which case such removed items will become Contractor's property.

Existing materials and equipment removed by Contractor shall not be reused in the Work, except where so specified or indicated.

8. LAND FOR CONSTRUCTION PURPOSES. Contractor will be permitted to use available land belonging to Owner or identified as Temporary Construction Easement, on or near the Site, for construction purposes and for storage of materials and equipment.

The locations and extent of the areas so used shall be as described in the legal description below.

Contractor shall immediately move stored materials or equipment if any occasion arises, as determined by Owner, requiring access to the storage area. Materials or equipment

shall not be placed on the property of Owner until Owner has agreed to the location to be used for storage.

LEGAL DESCRIPTION NO.1:

Commence at the Southeast corner of the Southwest 1/4 of Section 26, Township 23 South, Range 28 East. Thence run along the East line of the Southwest 1/4 of said Section 26, N 00°07'03" W for 60.00 feet to the Northerly right of way line of Sand Lake Road (State Road #482). Thence continue along said East line of the Southwest 1/4, N 00°07'03" W for 175.00 feet to the North line of lands described in Official Records Book 2335, Page 362, and Point of Beginning. Thence run along said North line N 89°42'14" W for 50.00 feet to a point, said point also lies on the North line of Spring Lake Plaza, as described in Plat Book 28, Page 124, Public Records of Orange County, Florida. Thence run along said North line N 75°09'31" E for 3.11 feet to a point. Thence run N 00°07'03" W for 9.22 feet to a point. Thence run S 89°42'12" E for 53.00 feet to a point. Thence run S 00°07'03" E for 10.00 feet to the Point of Beginning. Said described easement is a portion of Bay View Reserve, a Condominium per Condominium Book 12, Page 1, said easement also lies in Section 26, Township 23 South, Range 28 East. Containing 529 sq. ft.±

LEGAL DESCRIPTION NO.2:

Commence at the Southeast corner of the Southwest 1/4 of Section 26, Township 23 South, Range 28 East. Thence run along the East line of the Southwest 1/4 of said Section 26, N 00°07'03" W for 60.00 feet to the Northerly right of way line of Sand Lake Road (State Road #482). Thence run along said Northerly right of way line N 89°42'14"W for 50.00 feet to the Point of Beginning. Thence continue along said Northerly right of way line N 89°42'14" W for 3.00 feet to a point. Thence run N 00°07'03" W for 175.78 feet to a point on the North line of Spring Lake Plaza as described in Plat Book 28, Page 124, Public Records of Orange County, Florida. Thence run along said North line S 75°09'31" E for 3.11 feet to a point on the West line of lands described in Official Records Book 2335, Page 362. Thence run along said West line S 00°07'03"E for 175.00 feet to the Point of Beginning. Said lands lying in Section 26, Township 23 South, Range 28 East. Containing 526 sq. ft.±

9. EASEMENTS. The easements, temporary construction easements as indicated on the drawings and rights-of-way for the pipelines will be provided by Owner. Contractor shall confine its construction operations within the limits indicated on the Drawings. Contractor shall use due care in placing construction tools, equipment, excavated materials, and pipeline materials and supplies in order to avoid damage to property and interference with traffic.

9.01. On Private Property. Easements across private property are indicated on the Drawings. Contractor shall set stakes to mark the boundaries of construction easements

across private property. Contractor shall furnish, without charge, competent persons and such tools, stakes, and other materials as Engineer may require in staking out the boundaries of construction easements. Contractor will not be required to provide an instrument person. The stakes shall be protected and maintained until completion of construction and cleanup.

Contractor shall not enter any private property outside the designated construction easement boundaries without written permission from the owner of the property.

9.02. Work Within Highway. Permits shall be obtained by Owner. All Work performed and all operations of Contractor, its employees, or Subcontractors within the limits of highway rights-of-way shall be in conformity with the requirements and be under the control (through Owner) of the highway authority owning, or having jurisdiction over and control of, the right-of-way in each case.

10. OPERATION OF EXISTING FACILITIES. The existing facilities must be kept in continuous operation throughout the construction period. No interruption will be permitted which adversely affects the degree of service provided. Provided permission is obtained from Owner in advance, portions of the existing facilities may be taken out of service for short periods corresponding with periods of minimum service demands.

Contractor shall provide temporary facilities and make temporary modifications as necessary to keep the existing facilities in operation during the construction period.

Bypass pumping procedures shall be in accordance with with Section 1516 of the Specifications and Orange County Utilities Standard and Construction Specifications Manual "Section 3312" for Collection System Bypass. In case of conflict, the more stringent of the two standards shall apply.

11. NOTICES TO OWNERS AND AUTHORITIES. Contractor shall, as provided in the General Conditions, notify owners of adjacent property and utilities when prosecution of the Work may affect them.

When it is necessary to temporarily deny access to property, or when any utility service connection must be interrupted, Contractor shall give notices sufficiently in advance to enable the affected persons to provide for their needs. Notices shall conform to any applicable local ordinance and, whether delivered orally or in writing, shall include appropriate information concerning the interruption and instructions on how to limit inconvenience caused thereby.

Utilities and other concerned agencies shall be notified at least 24 hours prior to cutting or closing streets or other traffic areas or excavating near underground utilities or pole lines.

12. LINES AND GRADES. All Work shall be done to the lines, grades, and elevations indicated on the Drawings.

Basic horizontal and vertical control points (benchmarks) have been designated on the drawings to be used as datums for the Work. All additional survey, layout, and measurement work shall be performed by Contractor as a part of the Work.

Contractor shall provide an experienced instrument person, competent assistants, and such instruments, tools, stakes, and other materials required to complete the survey, layout, and measurement work. In addition, Contractor shall furnish competent persons and such tools, stakes, and other materials as required in establishing control points, in establishing construction easement boundaries, or in checking survey, layout, and measurement work performed by Contractor.

Contractor shall remove and reconstruct work which is improperly located.

13. CONNECTIONS TO EXISTING FACILITIES. Unless otherwise specified or indicated, Contractor shall make all necessary connections to existing facilities, including structures, drain lines, and utilities such as water, sewer, gas, telephone, and electric. In each case, Contractor shall receive permission from Owner or the owning utility prior to undertaking connections. Contractor shall protect facilities against deleterious substances and damage.

Connections to existing facilities which are in service shall be thoroughly planned in advance, and all required equipment, materials, and labor shall be on hand at the time of undertaking the connections. Work shall proceed continuously (around the clock) if necessary to complete connections in the minimum time. Operation of valves or other appurtenances on existing utilities, when required, shall be by or under the direct supervision of the owning utility.

14. UNFAVORABLE CONSTRUCTION CONDITIONS. During unfavorable weather, wet ground, or other unsuitable construction conditions, Contractor shall confine its operations to work which will not be affected adversely by such conditions. No portion of the Work shall be constructed under conditions which would affect adversely the quality or efficiency thereof, unless special means or precautions are taken by Contractor to perform the Work in a proper and satisfactory manner.

15. CUTTING AND PATCHING. As provided in General Conditions, Contractor shall perform all cutting and patching required for the Work and as may be necessary in connection with uncovering Work for inspection or for the correction of defective Work.

Contractor shall perform all cutting and patching required for and in connection with the Work, including but not limited to the following:

Removal of improperly timed Work.

Removal of samples of installed materials for testing.

Alteration of existing facilities.

Installation of new Work in existing facilities.

Contractor shall provide all shoring, bracing, supports, and protective devices necessary to safeguard all Work and existing facilities during cutting, patching and excavating operations. Contractor shall not undertake any cutting or demolition which may affect the structural stability of the Work or existing facilities.

Materials shall be cut and removed to the extent indicated on the Drawings or as required to complete the Work. Materials shall be removed in a careful manner, with no damage to adjacent facilities or materials. Materials which are not salvable shall be removed from the site by Contractor.

All Work and existing facilities affected by cutting operations shall be restored with new materials, or with salvaged materials acceptable to Engineer, to obtain a finished installation with the strength, appearance, and functional capacity required. If necessary, entire surfaces shall be patched and refinished.

16. ASBESTOS ABATEMENT. If, during the progress of the Work, suspected asbestos-containing products are identified, Contractor shall stop work in the affected area and engage an asbestos abatement Subcontractor to verify the materials and, if necessary, encapsulate, enclose, or remove and dispose of all asbestos in accordance with current regulations of the Environmental Protection Agency and the U. S. Department of Labor - Occupational Safety and Health Administration, the state asbestos regulating agency, and any local government agency. Payment for such work will be made by Change Order.

16.01. Subcontractor's Qualifications. The Subcontractor for asbestos abatement shall be regularly engaged in this type of activity and shall be familiar with the regulations which govern this work. The Subcontractor shall demonstrate to the satisfaction of Owner that it has successfully completed at least three asbestos abatement projects, that it has the necessary staff and equipment to perform the work, and that it has an approved site for disposal of the asbestos. Liability insurance covering the asbestos abatement work shall be provided as specified in the Supplementary Conditions.

16.02. Abatement Methods. The asbestos abatement Subcontractor shall submit a work plan of its proposed abatement procedure to Owner before beginning work and shall certify that the methods are in full compliance with the governing regulations. The work plan shall cover all aspects of the abatement, including health and safety of employees and building occupants, hygiene facilities, employee certification, clearance criteria, transportation and disposal, enclosure techniques, and other techniques appropriate for the proposed work.

17. CLEANING UP. Contractor shall keep the premises free at all times from accumulations of waste materials and rubbish. Contractor shall provide adequate trash receptacles about the Site and shall promptly empty the containers when filled.

Construction materials, such as concrete forms and scaffolding, shall be neatly stacked by Contractor when not in use. Contractor shall promptly remove splattered concrete, asphalt, oil, paint, corrosive liquids, and cleaning solutions from surfaces to prevent marring or other damage.

Volatile wastes shall be properly stored in covered metal containers and removed daily.

Wastes shall not be buried or burned on the Site or disposed of into storm drains, sanitary sewers, streams, or waterways. All wastes shall be removed from the Site and disposed of in a manner complying with local ordinances and antipollution laws.

Adequate cleanup will be a condition for recommendation of progress payment applications.

18. APPLICABLE CODES. References in the Contract Documents to local codes mean the following:

- Florida Building Code, latest version
- All ordinances of Orange County, Florida
- Florida Department of Environmental Protection
- Southwest Florida Water Management District
- Occupational Safety and Health Administration (OSHA) Standards Manual

Other standard codes which apply to the Work are designated in the Specifications.

19. REFERENCE STANDARDS. Reference to standards, specifications, manuals, or codes of any technical society, organization, or association, or to the laws or regulations of any governmental authority, whether such reference be specific or by implication, shall mean the latest standard specification, manual, code, or laws or regulations in effect at the time of opening of Bids (or on the effective date of the Contract or Agreement if there were no Bids), except as may be otherwise specifically stated in the Contract Documents. However, no provision of any referenced standard, specification, manual, or code, or any instruction of a Supplier, shall be effective to change the duties or responsibilities of Owner, Contractor, or Engineer, or any of their subcontractors, consultants, agents, or employees from those set forth in the Contract Documents, nor shall any such provision or instruction be effective to assign to Owner, Engineer, or any of Engineer's CONSULTANTS, agents, or employees, any duty or authority to supervise or direct the performance of the Work or any duty or authority to undertake responsibility inconsistent with the provisions of the Contract Documents.

20. PRECONSTRUCTION CONFERENCE. Prior to the commencement of Work at the Site, a preconstruction conference will be held at a mutually agreed time and place. The conference shall be attended by:

Contractor and its superintendent.

Principal Subcontractors.

Representatives of principal Suppliers and manufacturers as appropriate.

Engineer Representative.

Representatives of Owner.

Government representatives as appropriate.

Others as requested by Contractor, Owner, or Engineer.

Unless previously submitted to Owner Contractor shall bring to the conference a preliminary schedule for each of the following:

Progress Schedule.

Procurement Schedule.

Schedule of Values for progress payment purposes.

Schedule of Shop Drawings and other submittals.

The purpose of the conference is to designate responsible personnel and establish a working relationship. Matters requiring coordination will be discussed and procedures for handling such matters established. The agenda will include:

Contractor's preliminary schedules.

Transmittal, review, and distribution of Contractor's submittals.

Processing Applications for Payment.

Maintaining record documents.

Critical Work sequencing.

Field decisions and Change Orders.

Use of premises, office and storage areas, security, housekeeping, and Owner's needs.

Major equipment deliveries and priorities.

Contractor's assignments for safety and first aid.

Engineer will preside at the conference and will arrange for keeping the minutes and distributing the minutes to all persons in attendance.

21. PROGRESS MEETINGS. Contractor shall schedule and hold regular progress meetings at least monthly and at other times as requested by Owner, or required by progress of the Work. Contractor, Engineer, and all Subcontractors active on the Site shall be represented at each meeting. Contractor may at its discretion request attendance by representatives of its Suppliers, manufacturers, and other Subcontractors.

Contractor shall preside at the meetings. Meeting minutes shall be prepared and distributed by Contractor. The purpose of the meetings will be to review the progress of the Work, maintain coordination of efforts, discuss changes in scheduling, and resolve other problems which may develop.

22. SITE ADMINISTRATION. Contractor shall be responsible for all areas of the Site used by it and by all Subcontractors in the performance of the Work. Contractor shall exert full control over the actions of all employees and other persons with respect to the use and preservation of property and existing facilities, except such controls as may be specifically reserved to Owner or others. Contractor shall have the right to exclude from the Site all persons who have no purpose related to the Work or its inspection, and may require all persons on the Site (except Owner's employees) to observe the same regulations as Contractor requires of its employees.

End of Section

THIS PAGE LEFT BLANK INTENTIONALLY

MEASUREMENT AND PAYMENT

1. GENERAL. The Contractor shall receive and accept the compensation provided in the Proposal and the Contract as full payment for furnishing all materials, labor, tools and equipment, for performing all operations necessary to complete the work under the Contract, and also in full payment for all loss or damages arising from the nature of work, or from any discrepancy between the actual quantities of work and quantities herein estimated by the Engineer, or from the action of the elements or from any unforeseen difficulties which may be encountered during the prosecution of the work until the final acceptance by the County.

The prices stated in the proposal include all costs and expenses for taxes, labor, equipment, materials, commissions, transportation charges and expenses, patent fees and royalties, labor for handling materials during inspection, together with any and all other costs and expenses for performing and completing the work as shown on the Drawings and specified herein. The basis of payment for an item at the unit price shown in the proposal shall be in accordance with the description of that item in this Section.

The Contractor's attention is again called to the fact that the quotations for the various items of work are intended to establish a total price for completing the work in its entirety. Should the Contractor feel that the cost for any item of work has not been established by the Bid Form or Payment Items, he shall include the cost for that work in some other applicable bid item, so that his proposal for the project does reflect his total price for completing the work in its entirety.

2. MEASUREMENT. The quantities for payment under this Contract shall be determined by actual measurement of the completed items, in place, ready for service and accepted by the County, in accordance with the applicable method of measurement therefore contained herein.

3. PAYMENT ITEMS. Items are as enumerated on the bid form.

3.01. Item 1 – Dr. Phillips Pump Station #3151 Rehabilitation.

- a. Payment for all the other work associated with the construction of the Dr. Phillips Pump Station #3151 Rehabilitation will be made at the Contract lump sum price, based upon the approved schedule of values.
- b. This item shall include all materials, equipment, labor, testing, permits, appurtenances, and work required for the Dr. Phillips Pump Station #3151 Rehabilitation including all work and costs not listed elsewhere.
- c. This item shall include costs for General Requirements, Mobilization, and Demobilization. Measurement for various items covered under General Requirements, Mobilization and Demobilization will not be made for payment, and all items shall be included in the lump sum price.

- d. Payment for General Requirements shall include all Insurance requirement costs, the cost of bonds, and all Administrative costs. This item will be paid upon each payment request made by the Contractor. The Contractor shall attach with the pay request invoices to substantiate that appropriate insurance and bonds have been obtained by the Contractor.
- e. Payment for Mobilization/Demobilization will be made at the Contract lump sum price for the item, which price and payment shall be full compensation for the Work consisting of the preparatory Work and operations in mobilizing for beginning Work on the Contract, including, but not limited to, furnishing those supplies and incidentals to the project site, preparation of submittals, and for the establishment of temporary offices and buildings, safety equipment and first aid supplies, project signs, field surveys, sanitary and other facilities required by these specifications, and State and local laws and regulations. The costs of bonds and any required insurance and any other preconstruction expense necessary for the start of the work, excluding the cost of construction materials, shall also be included. This Work also consist of the general project management of the Work including, but not limited to, field supervision and office management, as well as other incidental cost for management of the Work during the duration of the Contract. This Work also includes maintenance of the field offices for the duration of the Contract. The Work specified in this item also consists of demobilization or the operations normally involved in ending Work on the project including, but not limited to, termination and removal of temporary utility service and field offices; demolition and removal of temporary structures and facilities; restoration of Contractor storage areas; disposal of trash and rubbish, and any other post-construction work necessary for the proper conclusion of the Work. This pay item may not exceed 5% of the Total Base Bid amount.
- f. Payment for Indemnification: In consideration of the Contractor's Indemnity Agreement as set out in the Contract Documents, County specifically agrees to give the Contractor \$100.00 and other good and valuable consideration, receipt of which is acknowledged upon signing of the Agreement.

End of Section

PERMITS AND REGULATORY REQUIREMENTS

PART 1 - GENERAL

1.01 RELATED SECTIONS: N/A

1.02 REGULATORY AGENCIES:

A.General: The Contractor shall;

- a. Obtain and pay for all permits and licenses as provided for in the General Conditions, except as otherwise specified herein.
- b. Schedule all inspections and obtain all written approvals of the agencies required by the permits and licenses.
- c. Comply with all conditions specified in each of the permits and licenses.
- d. A copy of the permits obtained by the County will be furnished to the Contractor upon request.

1.03 PERMITS OBTAINED BY THE COUNTY:

A. The County will apply for and pay for the following permits:

- a. The initial Orange County Building Permit.
- b. FDEP Wastewater Collection System for the on-site lift station.
- c. FDEP Permit for fuel storage tank and generator.

1.04 PERMITS OBTAINED BY CONTRACTOR:

A. The Contractor shall be responsible for obtaining the following permits:

- a. The Contractor shall be responsible for obtaining the Orange County Building Permits, and shall pay for all permits subsequent to the initial Building Permit as required for various building trades such as mechanical, electrical, plumbing, roofing, etc.
- b. The Contractor shall, within 14 days of the date of the Notice-to-Proceed, prepare the application and pay fees associated with a Notice of Intent (NOI) to Use Generic Permit for Stormwater Discharge from Large and Small

Construction Activities and the Stormwater Pollution Prevention Plan (SPPP) for compliance with the USEPA's General Permit for construction activities.

- c. The Contractor shall apply and pay for the SFWMD Dewatering Permit.
- d. The Contractor shall apply and pay for the permits required for the temporary construction trailers.
- e. All other permits required for Contractor's operations or required elsewhere in Contract Documents and not included herein. Furnish three copies of permits to the Owner prior to performance of work authorized by permits.
- f. Contractor will be responsible for obtaining extensions to permits obtained by the Owner if construction authorized by permits has not been completed by expiration date noted on these permits.
- g. Permits may require that a representative of permitting agency be present at site during construction or prior to covering up of activity authorized by permit. Contractor will be responsible for notifying permitting agency in compliance with requirements of such permits.
- h. Contractor shall include time to obtain permits in his construction schedule.

PART 2 – PRODUCTS: N/A

PART 3 - EXECUTION: N/A

End of Section

ABBREVIATIONS OF TERMS AND ORGANIZATIONS

1. LIST OF ABBREVIATIONS. Abbreviations for standards and organizations used in the Contract Documents are defined as follows:

AA	Aluminum Association
AABC	Associated Air Balance Council
AAMA	Architectural Aluminum Manufacturers Association
AASHTO	American Association of State Highway and Transportation Officials
ABMA	American Boiler Manufacturers Association
ACI	American Concrete Institute
ACPA	American Concrete Pipe Association
AEIC	Association of Edison Illuminating Companies
AFBMA	Antifriction Bearing Manufacturers Association
AFPA	American Forest & Paper Association
AGA	American Gas Association
AGMA	American Gear Manufacturers Association
AHA	American Hardboard Association
AISC	American Institute of Steel Construction
AISI	American Iron and Steel Institute
AITC	American Institute of Timber Construction
AMCA	Air Moving and Conditioning Association
ANSI	American National Standards Institute
APA	American Plywood Association
API	American Petroleum Institute
AREMA	American Railway Engineers and Maintenance-of-Way Association
ARI	American Refrigeration Institute
ASAHC	American Society of Architectural Hardware Consultants
ASCE	American Society of Civil Engineers
ASHRAE	American Society of Heating, Refrigerating, and Air- Conditioning Engineers
ASME	American Society of Mechanical Engineers
ASSE	American Society of Sanitary Engineers
ASTM	American Society for Testing and Materials
AVATI	See RTI
AWG	American Wire Gage
AWI	Architectural Woodwork Institute
AWPA	American Wood-Preservers' Association
AWPB	American Wood Preservers Bureau
AWS	American Welding Society
AWWA	American Water Works Association

BHMA	Builders Hardware Manufacturers Association
BIA	Brick Institute of America (formerly SCPI)
CDA	Copper Development Association
CISPI	Cast Iron Soil Pipe Institute
CMAA	Crane Manufacturers Association of America
CRA	California Redwood Association
CRSI	Concrete Reinforcing Steel Institute
CS	Commercial Standard (U.S. Department of Commerce)
DHI	Door and Hardware Institute
DIPRA	Ductile Iron Pipe Research Association
EEI	Edison Electric Institute
EJCDC	Engineers' Joint Contract Documents Committee
EPA	Environmental Protection Agency
FCC	Federal Communications Commission
FCI	Fluid Controls Institute
Fed Spec	Federal Specification
FGMA	Flat Glass Marketing Association
FHWA	Federal Highway Administration
FIA	Factory Insurance Association
FM	Factory Mutual
FSA	Fluid Sealing Association
FTI	Facing Tile Institute
HEI	Heat Exchange Institute
HMI	Hoist Manufacturers Institute
HPMA	Hardwood Plywood Manufacturers Association
HTI	Hand Tools Institute
I-B-R	Institute of Boiler and Radiator Manufacturers
IEEE	Institute of Electrical and Electronics Engineers
IBC	International Building Code
IES	Illuminating Engineering Society
IFI	Industrial Fasteners Institute
IPCEA	Insulated Power Cable Engineers Association
IRI	Industrial Risk Insurers
ISA	Instrumentation, Systems, and Automation Society
MHI	Materials Handling Institute
MIL	Military Specification
MMA	Monorail Manufacturers Association
MSS	Manufacturers Standardization Society of Valve and Fitting Industry

NAAMM	National Association of Architectural Metals Manufacturers
NACE	NACE International
NBHA	National Builders Hardware Association
NBBPVI	National Board of Boiler and Pressure Vessel Inspectors
NBS	See NIST
NCSPA	National Corrugated Steel Pipe Association
NEBB	National Environmental Balancing Bureau
NEC	National Electrical Code
NECA	National Electrical Contractors Association
NEMA	National Electrical Manufacturers Association
NEMI	National Elevator Manufacturing Industry
NFPA	National Fire Protection Association
NIST	National Institute of Standards and Technology (formerly NBS)
NLA	National Lime Association
NPC	National Plumbing Code
NPT	National Pipe Thread
NRMCA	National Ready Mixed Concrete Association
NSC	National Safety Council
NSF	NSF International (formerly National Sanitation Foundation)
NTMA	National Terrazzo and Mosaic Association
NWMA	National Woodwork Manufacturers Association
OSHA	Occupational Safety and Health Administration
PCA	Portland Cement Association
PCI	Prestressed Concrete Institute
PS	Product Standard
RIS	Redwood Inspection Service
RTI	Resilient Tile Institute (formerly AVATI)
SAE	Society of Automotive Engineers
SCPRF	Structural Clay Products Research Foundation
SDI	Steel Door Institute
SFPA	Southern Forest Products Association
SI	Système International des Unités (International System of Units)
SIGMA	Sealed Insulating Glass Manufacturers Association
SJI	Steel Joist Institute
SMA	Screen Manufacturers Association
SMACNA	Sheet Metal and Air Conditioning Contractors National Association
SPFA	Steel Plate Fabricators Association
SPI	Society of the Plastics Industry
SPTA	Southern Pressure Treaters Association
SSI	Scaffolding and Shoring Institute
SSPC	SSPC: The Society for Protective Coatings

UL	Underwriters' Laboratories
USBR	U.S. Bureau of Reclamation
WEF	Water Environment Federation

End of Section

SUBMITTALS

1. SHOP DRAWINGS AND ENGINEERING DATA.

1.01. **General.** Shop Drawings and engineering data (submittals) covering all equipment and all fabricated components and building materials which will become a permanent part of the Work under this Contract shall be submitted to Engineer for review, as required. Submittals shall verify compliance with the Contract Documents, and shall include drawings and descriptive information in sufficient detail to show the kind, size, arrangement, and the operation of component materials and devices; the external connections, anchorages, and supports required; the performance characteristics; and dimensions needed for installation and correlation with other materials and equipment.

Each submittal shall cover items from only one section of the specification unless the item consists of components from several sources. Contractor shall submit a complete initial submittal including all components. When an item consists of components from several sources, Contractor's initial submittal shall be complete including all components.

All submittals, regardless of origin, shall be approved by Contractor and clearly identified with the name and number of this Contract, Contractor's name, and references to applicable specification paragraphs and Contract Drawings. Each copy of all submittals, regardless of origin, shall be stamped or affixed with an approval statement of Contractor. Each submittal shall indicate the intended use of the item in the Work. When catalog pages are submitted, applicable items shall be clearly identified and inapplicable data crossed out. The current revision, issue number, and date shall be indicated on all drawings and other descriptive data.

Contractor shall be solely responsible for the completeness of each submittal. Contractor's stamp or affixed approval statement of a submittal, per Figure 01300-1, is a representation to Owner and Engineer that Contractor accepts sole responsibility for determining and verifying all quantities, dimensions, field construction criteria, materials, catalog numbers, and similar data, and that Contractor has reviewed and coordinated each submittal with the requirements of the Work and the Contract Documents. Submittals without Contractor's approval statement will be returned without review.

All deviations from the Contract Documents shall be identified as deviations on each submittal and shall be tabulated in Contractor's letter of transmittal using Figure 01300-2. Such submittals shall, as pertinent to the deviation, indicate essential details of all changes proposed by Contractor (including modifications to other facilities that may be a result of the deviation) and all required piping and wiring diagrams. The Contractor shall Mark his corrections in green ink.

For hard copy submittals six copies of each drawing and the necessary data shall be submitted to Engineer. Engineer will return three marked copies (or one marked reproducible copy) to Contractor. Facsimile (fax) or electronic copies will not be acceptable. Engineer will not accept submittals from anyone but Contractor. Submittals shall be consecutively numbered in direct sequence of submittal and without division by subcontracts or trades.

1.02. Engineer's Review of Submittals. Engineer's review of submittals covers only general conformity to the Drawings and Specifications, external connections, and dimensions that affect the layout; it does not indicate thorough review of all dimensions, quantities, and details of the material, equipment, device, or item covered. Engineer's review shall not relieve Contractor of sole responsibility for errors, omissions, or deviations in the drawings and data, nor of Contractor's sole responsibility for compliance with the Contract Documents.

Engineer's submittal review period shall be 30 consecutive calendar days and shall commence on the first calendar day following receipt of the submittal or resubmittal in Engineer's office. The time required to mail the submittal or resubmittal back to Contractor shall not be considered a part of the submittal review period.

When the drawings and data are returned with review status "NOT ACCEPTABLE" or "RETURNED FOR CORRECTION", the corrections shall be made as instructed by Engineer. Six corrected copies shall be resubmitted. Resubmittals by facsimile or e-mail will not be accepted. When the drawings and data are returned with review status "EXCEPTIONS NOTED", "NO EXCEPTIONS NOTED", or "RECORD COPY", no additional copies need be furnished unless specifically requested by Engineer.

1.03. Resubmittal of Drawings and Data. Contractor shall accept full responsibility for the completeness of each resubmittal. Contractor shall verify that all corrected data and additional information previously requested by Engineer are provided on the resubmittal.

When corrected copies are resubmitted, Contractor shall direct specific attention to all revisions in writing and shall list separately any revisions made other than those called for by Engineer on previous submittals. Requirements specified for initial submittals shall also apply to resubmittals. Resubmittals shall bear the number of the first submittal followed by a letter (A, B, etc.) or a unique identification that indicates the initial submittal and correct sequence of each resubmittal.

If more than one resubmittal is required because of failure of Contractor to provide all previously requested corrected data or additional information, Contractor shall reimburse Owner for the charges of Engineer for review of the additional resubmittals. This does not include initial submittal data such as shop tests and field tests that are submitted after initial submittal.

Resubmittals shall be made within 60 days of the date of the letter returning the material to be modified or corrected, unless within 30 days Contractor submits an acceptable request for an extension of the stipulated time period, listing the reasons the resubmittal cannot be completed within that time.

The need for more than one resubmittal, or any other delay in obtaining Engineer's review of submittals, will not entitle Contractor to extension of the Contract Times unless delay of the Work is the direct result of a change in the Work authorized by a Change Order or failure of Engineer to review and return any submittal to Contractor within the specified review period.

1.04. Color Selection. Contractor shall submit samples of colors and finishes for all accepted products before Engineer will coordinate the selection of colors and finishes with Owner. Engineer will prepare a schedule of finishes that include the colors and finishes selected for both

manufactured products and for surfaces to be field painted or finished and will furnish this schedule to Contractor within 60 days after the date of acceptance of the last color or finish sample.

2. OPERATION AND MAINTENANCE DATA AND MANUALS. Adequate operation and maintenance information shall be supplied for all equipment requiring maintenance or other attention. The equipment Supplier shall prepare a project specific operation and maintenance manual for each type of equipment indicated in the individual equipment sections or the equipment schedule.

Parts lists and operating and maintenance instructions shall be furnished for other equipment not listed in the individual equipment sections or the equipment schedule.

Operation and maintenance manuals shall include the following:

- a. Table of Contents and Index.
- b. Equipment function, normal operating characteristics, and limiting conditions.
- c. Assembly, installation, alignment, adjustment, and checking instructions.
- d. Operating instructions for startup, routine and normal operation, regulation and control, shutdown, and emergency conditions.
- e. Lubrication and maintenance instructions.
- f. Guide to troubleshooting.
- g. Parts lists and predicted life of parts subject to wear.
- h. Outline, cross section, and assembly drawings; engineering data; and wiring diagrams.
- i. Test data and performance curves, where applicable.

The operation and maintenance manuals shall be in addition to any instructions or parts lists packed with or attached to the equipment when delivered, or which may be required by Contractor.

Three preliminary hard copies of each manual shall be submitted to Engineer prior to the date of shipment of the equipment. When the O&M manuals are returned with the review status "RETURNED FOR CORRECTION", the corrections shall be made as instructed by the Engineer, and two copies of the corrected portion(s) and one complete corrected copy of the O&M manual returned to the Engineer. After review by Engineer is complete five hard copies and one electronic copy of each final operation and maintenance manual shall be prepared and delivered to Engineer not later than 30 days prior to placing the equipment in operation. ***One electronic copy of the final O&M Manual shall be submitted on CD-ROM. When corrections***

are required, a corrected version of the five hard copies and one electronic copy shall be resubmitted.

All material shall be marked with project identification, and inapplicable information shall be marked out or deleted.

Shipment of equipment will not be considered complete until all required manuals and data have been received.

2.01. Hard Copy Operation and Maintenance Manuals. Hard copies submitted for preliminary review shall be temporarily bound in heavy paper covers bearing suitable identification. All manuals and other data shall be printed on heavy, first quality 8-1/2 x 11 inch paper, with standard three-hole punching. Drawings and diagrams shall be reduced to 8-1/2 x 11 inches or 11 x 17 inches. Where reduction is not practicable, larger drawings shall be folded separately and placed in envelopes, which are bound into the manuals. Each envelope shall be suitably identified on the outside. Each volume containing data for three or more items of equipment shall include a table of contents and index tabs. The final hard copy of each manual shall be prepared and delivered in substantial, permanent, three-ring or three-post binders with a table of contents and suitable index tabs.

2.02. Electronic Operation and Maintenance Manuals. Electronic manuals shall be in Adobe Acrobat's Portable Document Format (PDF), and shall be prepared at a resolution of 300 dots per inch (dpi) or greater, depending on document type. Optical Character Recognition (OCR) capture shall be performed on these documents. OCR settings shall be performed with the "original image with hidden text" option in Adobe Acrobat Exchange.

When multiple files are required the least number of files possible shall be created. File names shall be in the format OMXXXXX-YYYZ-V.pdf, where XXXXX is the five digit number corresponding to the specification section, YYY is a three digit O&M manual number, e.g. 001, Z is the letter signifying a resubmittal, A, B, C, etc, and V is a number used only when more than one file is required for an O&M manual.

Documents prepared in PDF format shall be processed as follows:

1. Pages shall be searchable (processed for optical character recognition) and indexed when multiple files are required.
2. Pages shall be rotated for viewing in proper orientation.
3. A bookmark shall be provided in the navigation frame for each entry in the Table of Contents.
4. Embedded thumbnails shall be generated for each completed PDF file.
5. The opening view for PDF files shall be as follows:
 - Initial View: Bookmarks and Page
 - Page Number: Title Page (usually Page 1)
 - Magnification: Set to Fit in Window
 - Page: Single Page
6. Where the bookmark structure is longer than one page the bookmarks shall be collapsed to show the chapter headings only.

7. When multiple files are required the first file of the series (the parent file) shall list every major topic in the Table of Contents. The parent file shall also include minor headings bookmarked based on the Table of Contents. Major headings, whose content is contained in subsequent files (children) shall be linked to be called from the parent to the specific location in the child file. The child file shall contain bookmark entries for both major and minor headings contained in the child file. The first bookmark of any child file shall link back to the parent file and shall read as follows "Return to the *Equipment Name* Table of Contents", e.g. Return to the Polymer Feed System Table of Contents.
8. Drawings shall be bookmarked individually.
9. Files shall be delivered without security settings to permit editing, insertion and deletion of material to update the manual provided by the manufacturer.

2.03. Labeling. As a minimum, the following information shall be included on all final O&M manual materials, including CD-ROM disks, jewel cases, and hard copy manuals:

Equipment name and/or O&M title spelled out in complete words.
Project Name.
City Project/Contract Number.
Specification Section Number. Example: "Section 15500"
Manufacturer's name.
File Name and Date.

For example:

Backwash Pump Operation and Maintenance Manual
Somewhere Plant Expansion
Project/Contract No. ____
Specification Section 11110
Manufacturer
OM11110-001.pdf, 5/05/07

End of Section

This page was left blank intentionally

SUBMITTAL No. _____

SECTION _____

Do not combine multiple sections together unless required by specifications.

(Contractor's Letterhead)

SUBMITTAL IDENTIFICATION & CONTRACTOR'S APPROVAL STATEMENT

DATE: _____ COPIES _____ DRAWING SHEET NO. _____

Description submittal contents: _____

Location: _____

Manufacturer _____

Subcontractor or Supplier (Optional) _____

REMARKS: _____

CONTRACTOR'S APPROVAL

(_____ Construction Company) has reviewed and coordinated the submitted documentation and verifies that the equipment and material meet the requirements of the Work and the Contract Documents. We accept sole responsibility for determining and verifying all quantities, dimensions, field construction criteria, materials, catalog numbers, and similar data contained in the submittal as required by the Contract Documents.

Deviations: None Yes (See attached Figure 01300-2 for written description)

Approved By: _____ Date: _____

This approval does not release subcontractor / vendor from the contractual responsibilities.

THIS PAGE LEFT BLANK INTENTIONALLY

SUBMITTAL No. _____

SECTION _____

Do not combine multiple sections together unless required by specifications.

(Contractor's Letterhead)

SUBMITTAL IDENTIFICATION & CONTRACTOR'S APPROVAL STATEMENT

DATE: _____ **COPIES** _____ **DRAWING SHEET NO.** _____

Description submittal contents: _____

Location: _____

Manufacturer _____

Subcontractor or Supplier (Optional) _____

DEVIATIONS

THIS PAGE LEFT BLANK INTENTIONALLY

CONSTRUCTION SCHEDULING

1. CRITICAL PATH PROGRESS SCHEDULE. A critical path Progress Schedule shall be submitted by Contractor. The schedule shall consist of an arrow diagram and associated listings, and shall cover all Work to be done on the Project. The critical path Progress Schedule shall be submitted within 14 days after the Notice to Proceed. The firm or individual employed by Contractor to prepare the critical path schedule shall be competent and experienced in critical path scheduling.

1.01. Arrow Diagram. The arrow diagram shall be sufficiently detailed to indicate such activities as shop drawing submittal and review, equipment manufacture and delivery, installation of equipment, concrete pours, and Subcontractors' items of work. Construction activities of less than 1 day's duration or more than 5 days' duration shall be kept to a minimum. The arrow diagram shall be prepared so that the final diagram will fit on a drawing of approximately 30 x 42 inches [750 x 1050 mm]. Each activity on the arrow diagram shall be labeled with the following information: description, duration, scheduled start date, latest completion date, and total float. The critical path of activities shall be indicated on the arrow diagram by a heavy line.

1.02. Listings. Two chronological listings of the information in the arrow diagram shall be prepared: one for scheduled start dates and one for latest completion dates. Each listing shall show activity node numbers, description, scheduled start date, duration in workdays, latest completion date, and total float for each item in the arrow diagram.

1.03. Submittal. The initial critical path schedule and subsequent revisions shall reflect the actual progress of the Project to within 5 days prior to submittal. Contractor and its representative who prepared the schedule shall meet with Engineer and Owner to review the initial schedule and each subsequent revision. The meeting will be held in the office of Owner or Engineer.

At least 6 copies of the arrow diagram and listings shall be submitted. A revised arrow diagram and listing shall be prepared and submitted at a minimum frequency of 60 days.

If the initial schedule or any subsequent revision is not acceptable to Owner, the schedule shall be revised and resubmitted as many times as necessary until the schedule is acceptable. Acceptance of the schedule will not be unreasonably withheld.

1.04. Shop Drawings Schedule. At the time the initial critical path schedule is submitted, a schedule shall be submitted of the items of materials and equipment for which Shop Drawings are required by the Specifications. For each required Shop Drawing, the date shall be given for intended submission of the drawing to Engineer for review and the date required for its return to avoid delay in any activity beyond the scheduled start date. Sufficient time shall be allowed for initial review, correction and resubmission, and final review of all Shop Drawings. In no case will a schedule be acceptable which allows less than the number of calendar days specified in Section 01300, Submittals, for Engineer's submittal review.

1.05. Progress Reports. At the end of each month, the node numbers of the activities that have been completed, with their actual start and completion dates, and a list of the activities on which Work is currently in progress and the number of working days required to complete each, shall be submitted to Engineer.

If, at any time during the Project, any activity is not completed by its latest scheduled completion date, Engineer shall be notified within 5 days of Contractor's plans to reorganize the workforce to return to the schedule and prevent delays on any other activity. Owner may require Contractor, at Contractor's expense, to add to its plant, equipment, or construction forces, as well as increase the working hours, if operations fall behind schedule.

Any Work reported complete, but which is not readily apparent to Engineer, must be substantiated with satisfactory evidence.

1.06. Sequence. The following information provides a suggested sequence for construction operations that must be phased and items that shall be taken into consideration in preparing the proposed schedule of construction operations. Other sequences proposed by Contractor will be considered.

The new pump station shall be constructed and fully functional prior to taking the existing one out of service.

PS#3151 Dr. Phillips

- Under no circumstances shall the transfer of wastewater flow in and out of this pump station site be stopped.
- A generator, portable or permanent, shall be provided and connected at all times during construction activities to provide back up electrical power. The Contractor shall make all arrangements with the power company for relocating electrical service, pay all power company charges and furnish all labor and material required for the electrical service.
- A new doghouse manhole may be constructed around the existing 12" gravity influent pipe and that new manhole may be used to bypass pump influent flow to the existing wetwell to allow construction of new 36" gravity piping between MH3151-2 and junction box.
- A temporary or permanent SCADA antenna shall be maintained in operation at all times.
- The new pump station shall operate continuously for 72 hours without fail. Bypass pumping capabilities shall remain on-site until successful completion of the 72 hour test period.
- After successful operation of the new pump station for 72 hours, all bypass pumping equipment can be removed from the site.

End of Section

CONSTRUCTION PROGRESS DOCUMENTATION

1. GENERAL.

1.01. Units of Measurement. When both inch-pound (English) and SI (metric) units of measurement are specified herein, the values expressed in inch-pound units shall govern.

2. SCHEDULE OF VALUES. After review of the preliminary schedule at the preconstruction conference, and before submission of the first Application for Payment, Contractor shall prepare and submit to Engineer a Schedule of Values covering each lump sum item. The Schedule of Values, showing the value of each kind of work, shall be acceptable to Engineer before any Application for Payment is prepared.

The sum of the items listed in the Schedule of Values shall equal the Contract Price. Such items as Bond premium, temporary construction facilities, and plant may be listed separately in the Schedule of Values, provided the amounts can be substantiated. Overhead and profit shall not be listed as separate items.

The Schedule of Values shall have sufficient detail such that partial completion of separable items of work can easily be calculated. The Schedule of Values shall have separate lines for manufacturer's field services, O&M manuals, and performance testing for each item of equipment requiring such services.

An unbalanced Schedule of Values providing for overpayment of Contractor on items of Work which would be performed first will not be accepted. The Schedule of Values shall be revised and resubmitted until acceptable to Engineer. Final acceptance by Engineer shall indicate only consent to the Schedule of Values as a basis for preparation of applications for progress payments, and shall not constitute an agreement as to the value of each indicated item.

3. SCHEDULE OF PAYMENTS. Within 30 days after award of contract, Contractor shall furnish to Engineer a schedule of estimated monthly payments. The schedule shall be revised and resubmitted each time an Application for Payment varies more than 10 percent from the estimated payment schedule.

4. SURVEY DATA. All field books, notes, and other data developed by Contractor in performing surveys required as part of the Work shall be available to Engineer for examination throughout the construction period. All such data shall be submitted to Engineer with the other documentation required for final acceptance of the Work.

5. LAYOUT DATA. Contractor shall keep neat and legible notes of measurements and calculations made in connection with the layout of the Work. Copies of such data shall be furnished to the Resident Project Representative for use in checking Contractor's layout as provided in the project requirements section. All such data considered of value to Owner will be transmitted to Owner by Engineer with other records upon completion of the Work.

End of Section

THIS PAGE LEFT BLANK INTENTIONALLY

Section 01380

CONSTRUCTION PHOTOGRAPHS

1. CONSTRUCTION PHOTOGRAPHS BY CONTRACTOR. Contractor shall be responsible for the production of construction photographs as provided herein. Engineer shall designate the subject of each photograph.

Photographs of the entire site, and pertinent features thereof, shall be taken before the commencement of Work and promptly submitted to Engineer. The same views shall be rephotographed upon completion of all construction activities and submitted with Contractor's application for final payment. Additional photographs shall be made each month throughout the progress of the Work at such times as requested by Engineer, and submitted with Contractor's application for progress payment.

All photographs shall be color digital, produced by a competent professional photographer. Contractor shall submit the photographs electronically and two copies of 4 by 5 inch prints. Digital images shall be compiled on CD and provided with a descriptive index of the images. Prints shall be mounted on linen with flap for binding or enclosed in clear plastic binders, and marked with the name and number of the Contract, name of Contractor, description and location of view, and date photographed.

Engineer will transmit the digital files and one copy of the prints to Owner.

End of Section

This page was left blank intentionally

QUALITY CONTROL

1. TESTING SERVICES. All tests to determine compliance with the Contract Documents shall be performed by an independent commercial testing firm acceptable to Owner. The testing firm's laboratory shall be staffed with experienced technicians, properly equipped and fully qualified to perform the tests in accordance with the specified standards.

Testing services provided by Owner are for the sole benefit of Owner; however, test results shall be available to Contractor. Testing necessary to satisfy Contractor's internal quality control procedures shall be the sole responsibility of Contractor.

1.01. Testing Services Provided by Contractor. Unless otherwise specified, Contractor shall provide all testing services in connection with the following:

Concrete materials and design mixtures.

Masonry units and masonry grout and mortar materials and design mixtures.

Asphaltic concrete materials and design mixtures.

Embedment, fill, and backfill materials.

All other tests and engineering data required for Owner's review of materials and equipment proposed to be used in the Work.

Contractor shall obtain Owner's acceptance of the testing firm before having services performed, and shall pay all costs for these testing services.

1.02. Testing Services provided by Owner. Unless otherwise specified, Owner shall provide for tests made on the following materials and equipment:

Concrete.

Tests of masonry prisms.

Field control test of masonry.

Asphaltic concrete.

Moisture-density and relative density tests on embedment, fill, and backfill materials.

In-place field density tests on embedments, fills, and backfill .

Other materials and equipment at the discretion of Owner.

Testing, including sampling, will be performed by Owner or the testing firm's laboratory personnel, in the general manner indicated in the Specifications. Engineer shall determine the exact time, location, and number of tests, including samples.

Arrangements for delivery of samples and test specimens to the testing firm's laboratory will be made by Owner. The testing firm's laboratory shall perform all laboratory tests within a reasonable time consistent with the specified standards and shall furnish a written report of each test.

Contractor shall furnish all sample materials and cooperate in the testing activities, including sampling. Contractor shall interrupt the Work when necessary to allow testing, including sampling, to be performed. Contractor shall have no Claim for an increase in Contract Price or Contract Times due to such interruption. When testing activities, including sampling, are performed in the field by Owner or laboratory personnel, Contractor shall furnish personnel and facilities to assist in the activities.

1.03. Transmittal of Test Reports. Written reports of tests and engineering data furnished by Contractor for Engineer's review of materials and equipment proposed to be used in the Work shall be submitted as specified for Shop Drawings.

The laboratory retained by Owner will furnish copies of a written report of each test to the Contractor and Engineer.

2. MANUFACTURER'S FIELD SERVICES. Manufacturer's field services shall be as specified herein except as specifically specified in the respective equipment sections.

2.01. Services Furnished Under This Contract. An experienced, competent, and authorized representative of the manufacturer of each item of equipment for which field services are indicated in the respective equipment section or in the equipment schedule section shall visit the Site of the Work and inspect, check, adjust if necessary, and approve the equipment installation. In each case, the manufacturer's representative shall be present when the equipment is placed in operation. The manufacturer's representative shall revisit the jobsite as often as necessary until all trouble is corrected and the equipment installation and operation are satisfactory in the opinion of Engineer.

Each manufacturer's representative shall furnish to Owner, through Engineer, a written report certifying that the equipment has been properly installed and lubricated; is in accurate alignment; is free from any undue stress imposed by connecting piping or anchor bolts; and has been operated under full load conditions and that it operated satisfactorily.

All costs for these services shall be included in the Contract Price.

End of Section

Section 01500

TEMPORARY FACILITIES

Section 01500 – TEMPORARY FACILITIES - LIST OF SUBJECTS

1. UNITS OF MEASUREMENT
2. OFFICE AT SITE OF WORK
3. WATER
4. POWER
5. TELEPHONE SERVICE
6. SANITARY FACILITIES
7. MAINTENANCE OF TRAFFIC
 - 7.01. Temporary Bridges
 - 7.02. Detours
8. BARRICADES AND LIGHTS
9. FENCES
10. PROTECTION OF PUBLIC AND PRIVATE PROPERTY
11. DAMAGE TO EXISTING PROPERTY
12. TREE AND PLANT PROTECTION
13. SECURITY
14. ACCESS ROADS
15. PARKING
16. NOISE CONTROL
17. DUST CONTROL
18. TEMPORARY DRAINAGE PROVISIONS
19. EROSION CONTROL
20. POLLUTION CONTROL

This page was left blank intentionally

TEMPORARY FACILITIES

1. UNITS OF MEASUREMENT. When both inch-pound (English) and SI (metric) units of measurement are specified herein, the values expressed in inch-pound units shall govern.

2. OFFICE AT SITE OF WORK. During the performance of this Contract, Contractor shall maintain a suitable office at or near the Site which shall be the headquarters of its representative authorized to receive drawings, instructions, or other communication or articles. Any communication given to the said representative or delivered at Contractor's office at the Site in the representative's absence shall be deemed to have been delivered to Contractor.

Copies of the Drawings, Specifications, and other Contract Documents shall be kept at Contractor's office at the Site and available for use at all times.

2.01. Owner's Field Office Trailer. In addition to the Contractor's field office, Contractor shall provide a suitable field office for the Owner separate from the Contractor's office at the site for the exclusive use of the Owner throughout the period of construction until final completion.

Furnish, Equip, and maintain an office trailer for the sole use of the Owner, with secure entrance doors and one key per occupant. Provide entrance/exit steps at all exterior doors. Provide parking areas for County vehicles. No Contractor employees or equipment parking will be permitted on Owner parking areas. Contractor shall have Owner's field office fully functional prior to any construction activities.

Provide the following:

1. Area: 600 square feet minimum, with minimum dimensions 12 feet x 50 feet.
 - a. Divide trailer into two offices, one on each end, reception area, restroom, and conference hall.
 - b. Obtain prior approval of Engineer of floor plan. Each room shall have doors with integral locks, keyed alike.
2. Windows:
 - a. Minimum: 3, with a minimum total area of 10 percent of floor area.
 - b. Operable sash and insect screens.
 - c. Locate to provide view of construction areas.

- d. Provide operable Venetian blinds for all Windows.
3. Flooring:
- a. Provide VTC flooring throughout interior of trailer.
4. Furniture:
- a. Two (2) conference tables 30 inches x 96 inches with conference chairs.
 - b. Two (2) standard size desks, 3-foot x 5-foot with four drawers.
 - c. Two (2) office chairs with armrest, high back, swivel and reclining.
 - d. Two (2) plan tables: 36 inches x 60 inches.
 - e. Two (2) plan table stools with cushion and high backs.
 - f. One (1) plan rack to hold a minimum of six sets of project drawings.
 - g. One (1) standard four-drawer legal size metal filing cabinet with lock and keys (one key per occupant).
 - h. Two (2) wooden bookshelves with four shelves each.
 - i. Four (4) office chairs with armrest (2 per office).
 - j. Four (4) wastebaskets.
 - k. One (1) tack board, 30 inches x 48 inches.
 - l. One (1) dry erase board, 30 inches x 42 inches.
 - m. One (1) coat rack.
 - n. One (1) 5 cubic-foot refrigerator.
 - o. One (1) 1.5 cubic-foot microwave oven.
 - p. One (1) table for printer, copier, fax.
5. Office Equipment and Supplies:
- a. Two (2) fire extinguishers (per code).
 - b. One (1) plain paper facsimile (fax) machine with independent phone line.

- c. One (1) water cooler dispenser with hot and cold water valves, including water service for the duration of the Project.
- d. One (1) copier machine (sorter, double side copying, letter, legal and 11 x 17) with software for O.C. computer to operate.
- e. One (1) color printer Epson CX6600 or equal.
- f. Provide paper for copies in all sizes for the duration of the Project.
- g. Provide standard office supplies for the duration of the project.
- h. One (1) first-aid kit.

6. Office Communications:

- a. One (1) telephone system with minimum 3 rotary lines and 3 receivers, caller ID.
- b. One (1) telephone digital answering machine for 3 lines.
- c. Three (3) high-speed internet connections, at a minimum DSL, Roadrunner, etc., including e-mail service with connections in each office for the duration of the Project.
- d. Two (2) surge protector power strips.
- e. The field office telephone numbers will **not** be published publicly.

7. Services (AOD):

- a. Lighting: 50-foot-candles at desktop height.
- b. Exterior lighting at entrance door.
- c. Automatic heating and mechanical cooling equipment sufficient to maintain comfort conditions.
- d. Minimum of four 110-volt duplex electrical convenience outlets, at least one on each wall.
- e. Electric distribution panel: two circuits minimum, 110-volt, 60-hertz service.
- f. Equip washroom with flush toilet, washbasin with two faucets, medicine cabinet with supplies, toilet tissue holder, 10-gallon capacity automatic electric water heater, and paper towel holder.
- g. Provide potable water service to all trailer fixtures.

- h. Provide a single waste discharge to sanitary disposal system.
- i. Cleaning service for the duration of the Project (min. once per week).
- j. Furnish, replace, and replenish light bulbs, fluorescent tubes, toilet paper, paper towels, soap, etc.

3. WATER. All water required for and in connection with the Work to be performed will be furnished by Owner in the vicinity of the Site without charge to Contractor, provided:

- a. Contractor shall procure such water in the location and in the manner designated by Owner.
- b. Contractor at its own expense shall make authorized connections and provide means for delivering the water to the Site.
- c. Contractor shall provide adequately against waste and needless use of water.

4. POWER. Contractor shall provide all powers for heating, lighting, operation of Contractor's plant or equipment, or for any other use by Contractor. Temporary heat and lighting shall be maintained until the Work is accepted.

5. VOICE AND DATA SERVICES. Contractor shall make all necessary arrangements and pay all installation charges for voice and data lines in its offices at the Site and for the Owner's field office.

6. SANITARY FACILITIES. Contractor shall furnish temporary sanitary facilities at the Site, as provided herein, for the needs of all construction workers and others performing work or furnishing services on the Project.

Sanitary facilities shall be of reasonable capacity, properly maintained throughout the construction period, and obscured from public view to the greatest practical extent. If toilets of the chemically treated type are used, at least one toilet will be furnished for each 20 persons. Contractor shall enforce the use of such sanitary facilities by all personnel at the Site.

7. MAINTENANCE OF TRAFFIC. Contractor shall conduct its work to interfere as little as possible with public travel, whether vehicular or pedestrian. If Contractor's work impacts any public travel, Contractor shall coordinate all maintenance of traffic needs with Orange County Public Works and adhere to all local requirements for maintenance of traffic. Whenever it is necessary to cross, obstruct, or close roads, driveways, and walks, whether public or private, Contractor shall provide and maintain suitable and safe bridges, detours, or other temporary expedients for the accommodation of public and private travel, and shall give reasonable notice to owners of private drives before interfering with them. Such maintenance of traffic will not be required when Contractor has obtained permission from the owner and tenant of private property, or from the

authority having jurisdiction over public property involved, to obstruct traffic at the designated point.

In making open-cut street crossings, Contractor shall not block more than one-half of the street at a time. Whenever possible, Contractor shall widen the shoulder on the opposite side to facilitate traffic flow. Temporary surfacing shall be provided as necessary on shoulders.

7.01. Temporary Bridges. Contractor shall construct substantial bridges at all points where it is necessary to maintain traffic across pipeline construction. Bridges in public streets, roads, and highways shall be acceptable to the authority having jurisdiction thereover. Bridges erected in private roads and driveways shall be adequate for the service to which they will be subjected. Bridges shall be provided with substantial guardrails and with suitably protected approaches. Foot bridges shall be at least 4 feet wide, provided with handrails and uprights of dressed lumber. Bridges shall be maintained in place as long as the conditions of the Work require their use for safety of the public. When necessary for the proper prosecution of the Work in the immediate vicinity of a bridge, the bridge may be relocated or temporarily removed for such period as Engineer may permit.

7.02. Detours. Where required by the authority having jurisdiction thereover that traffic be maintained over any construction work in a public street, road, or highway, and the traffic cannot be maintained on the alignment of the original roadbed or pavement, Contractor shall, at its own expense, construct and maintain a detour around the construction work. Each detour shall include a bridge across the pipe trench and all necessary barricades, guardrails, approaches, lights, signals, signs, and other devices and precautions necessary for protection of the Work and safety of the public.

8. BARRICADES AND LIGHTS. All streets, roads, highways, and other public thoroughfares which are closed to traffic shall be protected by effective barricades on which shall be placed acceptable warning signs. Barricades shall be located at the nearest intersecting public highway or street on each side of the blocked section.

All open trenches and other excavations shall have suitable barricades, signs, and lights to provide adequate protection to the public. Obstructions, such as material piles and equipment, shall be provided with similar warning signs and lights.

All barricades and obstructions shall be illuminated with warning lights from sunset to sunrise. Material storage and conduct of the Work on or alongside public streets and highways shall cause the minimum obstruction and inconvenience to the traveling public.

All barricades, signs, lights, and other protective devices shall be installed and maintained in conformity with applicable statutory requirements and, where within railroad and highway rights-of-way, as required by the authority having jurisdiction thereover.

9. FENCES. All existing fences affected by the Work shall be maintained by Contractor until completion of the Work. Fences which interfere with construction operations shall

not be relocated or dismantled until written permission is obtained from the owner of the fence, and the period the fence may be left relocated or dismantled has been agreed upon. Where fences must be maintained across the construction easement, adequate gates shall be installed. Gates shall be kept closed and locked at all times when not in use.

On completion of the Work across any tract of land, Contractor shall restore all fences to their original or to a better condition and to their original locations.

10 PROTECTION OF PUBLIC AND PRIVATE PROPERTY. Contractor shall protect, shore, brace, support, and maintain all underground pipes, conduits, drains, and other underground construction uncovered or otherwise affected by its construction operations. All pavement, surfacing, driveways, curbs, walks, buildings, utility poles, guy wires, fences, and other surface structures affected by construction operations, together with all sod and shrubs in yards, parkways, and medians, shall be restored to their original condition, whether within or outside the easement. All replacements shall be made with new materials.

No trees shall be removed outside the permanent easement, except where authorized by Engineer.

Contractor shall be responsible for all damage to streets, roads, highways, shoulders, ditches, embankments, culverts, bridges, and other public or private property, regardless of location or character, which may be caused by transporting equipment, materials, or workers to or from the Work or any part or site thereof, whether by Contractor or its Subcontractors. Contractor shall make satisfactory and acceptable arrangements with the owner of, or the agency or authority having jurisdiction over, the damaged property concerning its repair or replacement or payment of costs incurred in connection with the damage.

All fire hydrants and water control valves shall be kept free from obstruction and available for use at all times.

11. DAMAGE TO EXISTING PROPERTY. Contractor will be held responsible for any damage to existing structures, Work, materials, or equipment because of his operations and shall repair or replace any damaged structures, Work, materials, or equipment to the satisfaction of, and at no additional cost to, Owner.

Contractor shall protect all existing structures and property from damage and shall provide bracing, shoring, or other work necessary for such protection.

12. TREE AND PLANT PROTECTION. All trees and other vegetation which must be removed to perform the Work shall be removed and disposed of by Contractor; however, no trees or cultured plants shall be unnecessarily removed unless their removal is indicated on the Drawings. All trees and plants not removed shall be protected against injury from construction operations.

Trees considered by Engineer to have any significant effect on construction operations are indicated on the Drawings and those which are to be preserved are so indicated.

Contractor shall take extra measures to protect trees designated to be preserved, such as erecting barricades, trimming to prevent damage from construction equipment, and installing pipe and other Work by means of hand excavation or tunneling methods. Such trees shall not be endangered by stockpiling excavated material or storing equipment against their trunks.

When injuring or removal of trees designated to be preserved cannot be avoided, or when removal and replacement is indicated on the Drawings, each tree injured beyond repair or removed shall be replaced with a similar tree of the nearest size possible.

All trimming, repair, and replacement of trees and plants shall be performed by qualified nurserymen or horticulturists.

13. SECURITY. Contractor shall be responsible for protection of the Site, and all Work, materials, equipment, and existing facilities thereon, against vandals and other unauthorized persons.

No Claim shall be made against Owner by reason of any act of an employee or trespasser, and Contractor shall make good all damage to Owner's property resulting from Contractor's failure to provide security measures as specified.

Security measures shall be at least equal to those usually provided by Owner to protect Owner's existing facilities during normal operation, but shall also include such additional security fencing, barricades, lighting, watchman services, and other measures as required to protect the Site.

14. ACCESS ROADS. Contractor shall establish and maintain temporary access roads to various parts of the Site as required to complete the Project. Such roads shall be available for the use of all others performing work or furnishing services in connection with the Project.

15. PARKING. Contractor shall provide and maintain suitable parking areas for the use of all workers and others performing work or furnishing services in connection with the Project, as required to avoid any need for parking personal vehicles where they may interfere with public traffic, Owner's operations, or construction activities.

16. NOISE CONTROL. Contractor shall take reasonable measures to avoid unnecessary noise. Such measures shall be appropriate for the normal ambient sound levels in the area during working hours. All construction machinery and vehicles shall be equipped with practical sound-muffling devices, and operated in a manner to cause the least noise consistent with efficient performance of the Work.

During construction activities on or adjacent to occupied buildings, and when appropriate, Contractor shall erect screens or barriers effective in reducing noise in the building and shall conduct its operations to avoid unnecessary noise which might interfere with the activities of building occupants.

17. DUST CONTROL. Contractor shall take reasonable measures to prevent unnecessary dust. Earth surfaces subject to dusting shall be kept moist with water or by application of a chemical dust suppressant. When practicable, dusty materials in piles or in transit shall be covered to prevent blowing dust.

Buildings or operating facilities which may be affected adversely by dust shall be adequately protected from dust. Existing or new machinery, motors, instrument panels, or similar equipment shall be protected by suitable dust screens. Proper ventilation shall be included with dust screens.

18. TEMPORARY DRAINAGE PROVISIONS. Contractor shall provide for the drainage of storm water and such water as may be applied or discharged on the Site in performance of the Work. Drainage facilities shall be adequate to prevent damage to the Work, the Site, and adjacent property.

Existing drainage channels and conduits shall be cleaned, enlarged, or supplemented as necessary to carry all increased runoff attributable to Contractor's operations. Dikes shall be constructed as necessary to divert increased runoff from entering adjacent property (except in natural channels), to protect Owner's facilities and the Work, and to direct water to drainage channels or conduits. Ponding shall be provided as necessary to prevent downstream flooding.

19. EROSION CONTROL. Contractor shall prevent erosion of soil on the Site and adjacent property resulting from its construction activities. Effective measures shall be initiated prior to the commencement of clearing, grading, excavation, or other operation that will disturb the natural protection.

Work shall be scheduled to expose areas subject to erosion for the shortest possible time, and natural vegetation shall be preserved to the greatest extent practicable. Temporary storage and construction buildings shall be located, and construction traffic routed, to minimize erosion. Temporary fast-growing vegetation or other suitable ground cover shall be provided as necessary to control runoff.

20. POLLUTION CONTROL. Contractor shall prevent the pollution of drains and watercourses by sanitary wastes, sediment, debris, and other substances resulting from construction activities. No sanitary wastes shall be permitted to enter any drain or watercourse other than sanitary sewers. No sediment, debris, or other substance shall be permitted to enter sanitary sewers, and reasonable measures shall be taken to prevent such materials from entering any drain or watercourse.

End of Section

Section 01516
COLLECTION SYSTEM BYPASS

PART 1 – GENERAL

1.01 SCOPE OF WORK

- A. The WORK covered by this section consists of providing all temporary bypassing to perform all operations in connection with the flow of wastewater around pipe segment(s) or pump stations. The purpose of bypassing is to prevent wastewater overflows and provide continuous service to all wastewater customers. The CONTRACTOR shall maintain wastewater flow in the construction area in order to prevent backup and/or overflow and provide reliable wastewater service to the users of the wastewater system at all times. Bypass flow design parameters shall be the same as performance requirements listed in Section 11150 paragraph 2-2.

PART 2 – PRODUCTS

2.01 GENERAL

- A. The CONTRACTOR shall provide and maintain adequate equipment, piping, tankers, and other necessary appurtenances in order to maintain continuous and reliable wastewater service in all wastewater lines as required for construction. The CONTRACTOR shall have tankers, backup pump(s), piping, and appurtenances ready to deploy immediately.

PART 3 – EXECUTION

3.01 GENERAL

- A. The CONTRACTOR shall have all materials, equipment and labor necessary to complete the repair, replacement, or rehabilitation on the job site prior to isolating the gravity main segment, manhole, or pump station. The CONTRACTOR shall demonstrate that the pumping system is in good working order and is sufficiently sized to successfully handle flows by performing a test run for a period of 24 hours prior to beginning the work.

3.02 TRAFFIC CONSIDERATIONS

- A. The CONTRACTOR shall locate bypass pumping suction and discharge lines so as to not cause undue interference with the use of streets, private driveways, and alleys to include the possible temporary trenching of piping at critical intersections. Ingress and egress to adjacent properties shall be maintained at all times. Ramps, steel plates or others methods shall be deployed by the CONTRACTOR to facilitate traffic over surface piping. High traffic commercial properties may require alternate methods.

3.03 BYPASS PLAN

- A. The CONTRACTOR shall submit to the COUNTY a comprehensive written plan for

approval and acceptance that describes the intended bypass for the maintenance of flows during construction. The CONTRACTOR shall also provide a sketch showing the location of bypass pumping equipment for each pump station or line segment(s) around which flows are being bypassed. The plan shall include any proposed tanker(s), pump(s), bypass piping, backup plan and equipment, work schedule, monitoring log for bypass pumping, monitoring plan of the bypass pumping operation, and maintenance of traffic plan. The CONTRACTOR shall cease bypass operations and return flows to the new and/or existing sewer when directed by the COUNTY. All piping shall be designed to withstand at least twice the maximum system pressure or a minimum of 50 psi whichever is greater. During bypassing, no wastewater shall be leaked, dumped, or spilled in or onto, any area outside of the existing wastewater system. When bypass operations are complete, all bypass piping shall be drained into the wastewater system prior to disassembly.

3.04 BYPASS OPERATION

- A. The COUNTY shall accept the bypass plan prior to implementation of the bypass. The CONTRACTOR shall plug off and pump down the sewer manhole or line segment in the immediate work area and shall maintain the wastewater system so that surcharging does not occur.
- B. Where work requires the line to be blocked beyond working hours and bypass pumping is being utilized, the CONTRACTOR shall be responsible for monitoring the bypass operation 24 hours per day, 7 days per week. If accepted in the bypass plan by the COUNTY, any electronic monitoring in lieu of on-site monitoring must be detailed in the comprehensive written plan and approved by the COUNTY.
- C. The CONTRACTOR shall ensure that no damage will be caused to private property as a result of bypass pumping operations. The CONTRACTOR shall complete the work as quickly as possible and satisfactorily pass all tests, inspections and repair all deficiencies prior to discontinuing bypassing operations and returning flow to the sewer manhole or line segment.
- D. The CONTRACTOR shall immediately notify the COUNTY should a sanitary sewer overflow occur and take the necessary action to clean up and disinfect the spillage to the satisfaction of the COUNTY or other governmental agency. If sewage is spilled onto public or private property, the CONTRACTOR shall wash down, clean up and disinfect the spillage to the satisfaction of the COUNTY. When bypassing a pump station, one back-up pump equal to the primary unit shall be required. Bypass pumps shall have a maximum rating of 55 decibels for sound attenuation.

3.05 CONTRACTOR LIABILITY

- A. The CONTRACTOR shall be responsible for all required pumping, equipment, piping, and appurtenances to accomplish the bypass and for any and all damage that results directly or indirectly from the bypass pumping equipment, piping and/or appurtenances. The CONTRACTOR shall also be liable for all COUNTY personnel and equipment costs, penalties and fines resulting from sanitary sewer overflows. It

is the intent of these specifications to require the CONTRACTOR to establish adequate bypass pumping as required regardless of the flow condition.

THIS PAGE LEFT BLANK INTENTIONALLY

GENERAL EQUIPMENT STIPULATIONS

1. SCOPE. When an equipment specification section in this Contract references this section, the equipment shall conform to the general stipulations set forth in this section, except as otherwise specified in other sections.
2. COORDINATION. Contractor shall coordinate all details of the equipment with other related parts of the Work, including verification that all structures, piping, wiring, and equipment components are compatible. Contractor shall be responsible for all structural and other alterations in the Work required to accommodate equipment differing in dimensions or other characteristics from that contemplated in the Contract Drawings or Specifications.
3. MANUFACTURER'S EXPERIENCE. Unless specifically named in the Specifications, a manufacturer shall have furnished equipment of the type and size specified which has been in successful operation for not less than the past 5 years.
4. WORKMANSHIP AND MATERIALS. Contractor shall guarantee all equipment against faulty or inadequate design, improper assembly or erection, defective workmanship or materials, and leakage, breakage, or other failure. Materials shall be suitable for service conditions.

All equipment shall be designed, fabricated, and assembled in accordance with recognized and acceptable engineering and shop practice. Individual parts shall be manufactured to standard sizes and thicknesses so that repair parts, furnished at any time, can be installed in the field. Like parts of duplicate units shall be interchangeable. Equipment shall not have been in service at any time prior to delivery, except as required by tests.

Except where otherwise specified, structural and miscellaneous fabricated steel used in equipment shall conform to AISC standards. All structural members shall be designed for shock or vibratory loads. Unless otherwise specified, all steel which will be submerged, all or in part, during normal operation of the equipment shall be at least 1/4 inch [6.3 mm] thick. When dissimilar metal components are used, consideration shall be given to prevention of galvanic corrosion.

5. LUBRICATION. Equipment shall be adequately lubricated by systems which require attention no more frequently than weekly during continuous operation. Lubrication systems shall not require attention during startup or shutdown and shall not waste lubricants.

Lubricants of the types recommended by the equipment manufacturer shall be provided in sufficient quantities to fill all lubricant reservoirs and to replace all consumption during testing, startup, and operation prior to acceptance of equipment by Owner.

Lubrication facilities shall be convenient and accessible. Oil drains and fill openings shall be easily accessible from the normal operating area or platform. Drains shall allow for convenient collection of waste oil in containers from the normal operating area or platform without removing the unit from its normal installed position.

6. ELEVATION. The elevation of the site shall be as indicated in the respective equipment specification sections. All equipment furnished shall be designed to meet stipulated conditions and to operate satisfactorily at the specified elevation.

7. ELECTRIC MOTORS. Unless otherwise specified, motors furnished with equipment shall meet the requirements specified in Section 16220 or specified in specific equipment sections.

8. DRIVE UNITS. The nominal input horsepower [kW] rating of each gear or speed reducer shall be at least equal to the nameplate horsepower [kW] of the drive motor. Drive units shall be designed for 24 hour continuous service.

8.01. Gearmotors. The use of gearmotors sharing an integral housing or cutgears into the motor output shaft, or that require removal of lubricant from the gear reducer to change out the motor will not be acceptable.

8.02. Gear Reducers. Each gear reducer shall be a totally enclosed unit with oil or grease lubricated, rolling element, antifriction bearings throughout.

Unless superseded by individual specification requirements each helical, spiral bevel, combination bevel-helical, and worm gear reducers shall have a service factor of at least 1.50 based on the nameplate horsepower [kilowatts] of the drive motor. Cycloidal gear reducers shall have a service factor of at least 2.0 based on the nameplate horsepower [kW] of the drive motor.

Shaft-mounted and flange-mounted gear reducers shall be rated AGMA Class III. Helical gear reducers shall have a gear strength rating to catalog rating of 1.5. Each gear reducer shall be designed and manufactured in compliance with applicable most current AGMA standards, except the L₁₀ bearing life shall be 200,000 hours.

The thermal horsepower [kW] rating of each unit shall equal or exceed the nameplate horsepower [kW] of the drive motor. During continuous operation, the maximum sump oil temperature shall not rise more than 100°F [38°C] above the ambient air temperature in the vicinity of the unit and shall not exceed 200°F [93°C].

Each grease lubricated bearing shall be installed in a bearing housing designed to facilitate periodic regreasing of the bearing by means of a manually operated grease gun. Each bearing housing shall be designed to evenly distribute new grease, to properly dispose of old grease, and to prevent overgreasing of the bearing. The use of permanently sealed, grease lubricated bearings will not be acceptable in large sized reducers. In small reducers, similar to basin equipment, permanently sealed grease lubricated bearings rated L₁₀ 200,000 hour life may be provided at the manufacturer's option. An internal or external oil pump and appurtenances shall be provided if required to properly lubricate oil lubricated bearings. A dipstick or a sight glass arranged to permit visual inspection of lubricant level shall be provided on each unit.

Gear reducers which require the removal of parts or the periodic disassembly of the unit for cleaning and manual regreasing of bearings will not be acceptable.

Certification shall be furnished by the gear reducer manufacturer indicating that the intended application of each unit has been reviewed in detail by the manufacturer and that the unit provided is fully compatible with the conditions of installation and service.

8.03. Adjustable Speed Drives. Each mechanical adjustable speed drive shall have a service factor of at least 1.75 at maximum speed based on the nameplate horsepower [kilowatts] of the drive motor. A spare belt shall be provided with each adjustable speed drive unit employing a belt for speed change. Unless specifically permitted by the detailed equipment specifications, bracket type mounting will not be acceptable for variable speed drives.

8.04. V-Belt Drives. Each V-belt drive shall include a sliding base or other suitable tension adjustment. V-belt drives shall have a service factor of at least 1.75 at maximum speed based on the nameplate horsepower [kilowatts] of the drive motor.

9. SAFETY GUARDS. All belt or chain drives, fan blades, couplings, and other moving or rotating parts shall be covered on all sides by a safety guard. Safety guards shall be fabricated from 16 USS gage [1.52 mm] thick or thicker galvanized, aluminum-clad sheet steel, or stainless sheet steel or from 1/2 inch [12.7 mm] mesh galvanized expanded metal, or poltrusion molded UV resistant materials. Each safety guard shall be reinforced or shaped to provide suitable strength to prevent vibration and deflection and shall comply with OSHA. Each guard shall be designed for easy installation and removal. All necessary supports and accessories shall be provided for each guard. Supports and accessories, including bolts, shall be galvanized. All safety guards in outdoor locations shall be designed to prevent the entrance of rain and dripping water.

10. ANCHOR BOLTS. Equipment suppliers shall furnish suitable anchor bolts for each item of equipment. Anchor bolts, together with templates or setting drawings, shall be delivered sufficiently early to permit setting the anchor bolts when the structural concrete is placed. Anchor bolts shall comply with the Anchorage in Concrete and Masonry section and, unless otherwise specified, shall be at least 3/4 inch [19 mm] in diameter.

Unless otherwise indicated or specified, anchor bolts for items of equipment mounted on baseplates shall be long enough to permit 1-1/2 inches [38 mm] of grout beneath the baseplate and to provide adequate anchorage into structural concrete.

11. EQUIPMENT BASES. Unless otherwise indicated or specified, all equipment shall be installed on concrete bases at least 6 inches [150 mm] high. Cast iron or welded steel baseplates shall be provided for pumps, compressors, and other equipment. Each unit and its drive assembly shall be supported on a single baseplate of neat design. Baseplates shall have pads for anchoring all components, and adequate grout holes. Baseplates for pumps shall have a means for collecting leakage and a threaded drain connection. Baseplates shall be anchored to the concrete base with suitable anchor bolts and the space beneath filled with grout as specified in the Grout section.

12. SPECIAL TOOLS AND ACCESSORIES. Equipment requiring periodic repair and adjustment shall be furnished complete with all special tools, instruments, and accessories required for proper maintenance. Equipment requiring special devices for lifting or handling shall be furnished complete with those devices.

13. SHOP PAINTING. All iron and steel surfaces of the equipment shall be protected with suitable protective coatings applied in the shop. Surfaces of the equipment that will be inaccessible after assembly shall be protected for the life of the equipment. Coatings shall be suitable for the environment where the equipment is installed. Exposed surfaces shall be finished, thoroughly cleaned, and filled as necessary to provide a smooth, uniform base for painting. Electric motors, speed reducers, starters, and other self-contained or enclosed components shall be shop primed or finished with an epoxy or polyurethane enamel or universal type primer suitable for top coating in the field with a universal primer and aliphatic polyurethane system.

Surfaces to be coated after installation shall be prepared for painting as recommended by the paint manufacturer for the intended service, and then shop painted with one or more coats of a universal primer.

Machined, polished, and nonferrous surfaces which are not to be painted shall be coated with rust-preventive compound as recommended by the equipment manufacturer.

14. PREPARATION FOR SHIPMENT. Equipment shall be prepared for shipment as specified in Section 01612 - Shipping.

15. STORAGE. Handling and storage of equipment shall be as specified in Section 01614 Handling and Storage.

16. INSTALLATION AND OPERATION. Installation and operation shall be as specified in respective equipment sections and Section 01650 Startup Requirements.

17. OBSERVATION OF PERFORMANCE TESTS. Where the Specifications require the presence of Engineer, initial tests shall be observed or witnessed by Engineer. Owner shall be reimbursed by Contractor for all costs of subsequent visits by Engineer to witness or observe incomplete tests, retesting, or subsequent tests.

18. PROGRAMMING SOFTWARE. Programming software shall be provided for any equipment which includes a programmable logic controller (PLC) or other digital controller that is user-programmable. The software shall be suitable for loading and running on a laptop personal computer operating with a Windows-based operating system. A copy of the manufacturer's original operating logic program shall be provided for use in maintaining and troubleshooting the equipment. Where multiple pieces of equipment, from the same or different vendors, use the same programming software, only one copy of the software need be provided.

End of Section

Section 01612

SHIPPING

1. SCOPE. This section covers packaging and shipping of materials and equipment.
2. PREPARATION FOR SHIPMENT. All equipment shall be suitably packaged to facilitate handling and to protect against damage during transit and storage. All equipment shall be boxed, crated, or otherwise completely enclosed and protected during shipment, handling, and storage. All equipment shall be protected from exposure to the elements and shall be kept dry at all times.

Painted and coated surfaces shall be protected against impact, abrasion, discoloration, and other damage. Painted and coated surfaces which are damaged prior to acceptance of equipment shall be repainted to the satisfaction of Engineer.

Grease and lubricating oil shall be applied to all bearings and similar items.

3. SHIPPING. Before shipping each item of equipment shall be tagged or marked as identified in the delivery schedule or on the Shop Drawings. Complete packing lists and bills of material shall be included with each shipment.

End of Section

This page was left blank intentionally

HANDLING AND STORAGE

1. SCOPE. This section covers delivery, storage, and handling of materials and equipment.
2. DELIVERY. Contractor shall bear the responsibility for delivery of equipment, spare parts, special tools, and materials to the site and shall comply with the requirements specified herein and shall provide required information concerning the shipment and delivery of the materials specified in this Contract. These requirements also apply to any subsuppliers making direct shipments to the jobsite.

Contractor shall, either directly or through contractual arrangements with others, accept responsibility for the safe handling and protection of the equipment and materials furnished under this Contract before and after receipt at the port of entry. Acceptance of the equipment shall be made after it is installed, tested, placed in operation and found to comply with all the specified requirements.

All items shall be checked against packing lists immediately on delivery to the site for damage and for shortages. Damage and shortages shall be remedied with the minimum of delay.

Delivery of portions of the equipment in several individual shipments shall be subject to review of Engineer before shipment. When permitted, all such partial shipments shall be plainly marked to identify, to permit easy accumulation, and to facilitate eventual installation.

3. STORAGE. Upon delivery, all equipment and materials shall immediately be stored and protected until installed in the Work.

Stacked items shall be suitably protected from damage by spacers or load distributing supports that are safely arranged. No metalwork (miscellaneous steel shapes and reinforcing steel) shall be stored directly on the ground. Masonry products shall be handled and stored in a manner to hold breakage, chipping, cracking, and spalling to a minimum. Cement, lime, and similar products shall be stored off the ground on pallets and shall be covered and kept completely dry at all times. Pipe, fittings, and valves may be stored out of doors, but must be placed on wooden blocking. PVC pipe, geomembranes, plastic liner, and other plastic materials shall be stored off the ground on pallets and protected from direct sunlight.

Pumps, motors, electrical equipment, and all equipment with antifriction or sleeve bearings shall be stored in weathertight structures maintained at a temperature above 60°F [16°C]. Electrical equipment, controls, and insulation shall be protected against moisture and water damage. All space heaters furnished in equipment shall be connected and operated continuously.

Equipment having moving parts, such as gears, bearings, and seals, shall be stored fully lubricated with oil, grease, etc., unless otherwise instructed by the manufacturer. Manufacturer's storage instructions shall be carefully followed by Contractor.

When required by the equipment manufacturer, moving parts shall be rotated a minimum of twice a month to ensure proper lubrication and to avoid metal to metal "welding". Upon installation of the equipment, Contractor shall, at the discretion of Engineer, start the equipment at one-half load for an adequate period of time to ensure that the equipment does not deteriorate from lack of use.

When required by the equipment manufacturer, lubricants shall be changed upon completion of installation and as frequently as required thereafter during the period between installation and acceptance. New lubricants shall be put into the equipment by Contractor at the time of acceptance.

Equipment and materials shall not show any pitting, rust, decay, or other deleterious effects of storage when installed in the Work.

In addition to the protection specified for prolonged storage, the packaging of spare units and spare parts shall be for export packing and shall be suitable for long-term storage in a damp location. Each spare item shall be packed separately and shall be completely identified on the outside of the container.

4. HANDLING. Stored items shall be laid out to facilitate their retrieval for use in the Work. Care shall be taken when removing the equipment for use to ensure the precise piece of equipment is removed and that it is handled in a manner that does not damage the equipment.

End of Section

Section 01620

EQUIPMENT SCHEDULE

1. **SCOPE.** This section consists of an equipment schedule for items for which a basic level of manufacturer's field services or operation and maintenance manuals are required, but not covered in other sections. When other sections indicate that manufacturer's field services and operation and maintenance manuals are required, the requirements shall be as specified in the other sections.

Specific requirements for manufacturer's field services are covered in the Quality Control section and the equipment specifications.

Specific requirements for operation and maintenance manuals are covered in the Submittals section and the equipment specifications.

2. **SCHEDULE.** Manufacturer's field services, including equipment installation checks and training, and operation and maintenance manuals shall be provided for the items of equipment indicated in the following schedule:

Spec Section	Type of Equipment	Mfr's. Field Services	O&M Manual
11150	Submersible Pumps	X	X
11291	Stainless Steel Sluice Gates	X	X
11910	Engine Generator	X	X
13214	Fuel Storage Tank	X	X
13530	Programmable Logic Controllers	X	X
13540	Radio Equipment	X	X
13561	Panel Mounted Instruments		X
13562	Flow Instrumentation	X	X
13563	Pressure and Level Instruments	X	X
13565	Miscellaneous Instruments		X
16150	Adjustable Frequency Drives		X
16425	Switchboards		X
16491	By-Pass Isolation Automatic Transfer Switch		X

End of Section

This page was left blank intentionally

PIPELINE SCHEDULE

1. SCOPE. This section consists of a schedule of 4 inch [100 mm] and larger pipelines indicating the type of pipe to be used. Pipe materials, installation, testing, and disinfection, when specified, are covered in other sections.

Piping smaller than 4 inches [100 mm] is covered in the various miscellaneous piping sections. Piping for plumbing, heating and air conditioning systems is covered in other sections. Piping to be furnished with equipment is covered in the applicable equipment section.

2. ALTERNATIVE PIPE TYPES. Where more than one type of pipe is indicated in the schedule, the type of pipe material to be installed may be selected by Contractor. The details on the drawings cover only one type of pipe for each line. If a different material is selected by Contractor, all details of connections, jointing, wall fittings, support, anchorage, and harnesses shall be modified as necessary to produce an equivalent design acceptable to Engineer.

3. WALL FITTINGS. A wall pipe or sleeve will be required for all pipe passing through concrete or masonry block walls. Wall fittings and sleeves shall be as indicated on the drawings and as specified in the applicable piping section.

4. SCHEDULE INDEX. Pipe material abbreviations and their applicable specification section number are as indicated:

<u>Abbreviation</u>	<u>Pipe Material</u>	<u>Section No.</u>
BR	Brass	15060
CPVC	CPVC	15067
CS	Miscellaneous steel pipe	15065
CSG	Galvanized steel pipe	15065
DIP	Ductile iron pipe	15061
FRP	FRP	15067
FRPA	FRP air pipe	15066
HS	Hose	15060
PE	Polyethylene	15067
PP	Polypropylene	15067

PVC	PVC	15067
PVCP	PVC pressure pipe	02630
PVCSP	PVC sewer pipe	02628
PVDF	PVDF	15067
RPT	Reinforced plastic tubing	15067
SS	Stainless steel pipe	15064
TG	Tempered glass	15060

5. SCHEDULE. Pipe materials shall conform to Schedule 01630-S01. All pipelines indicated on the drawings and all pipelines required for proper operation of the equipment furnished shall be provided whether listed in the schedule or not.

End of Section

STARTUP REQUIREMENTS

1. SCOPE. This section covers startup requirements for all items of equipment and systems including mechanical equipment. Additional requirements may be specified in specific equipment specifications. The requirements of this section shall be satisfactorily completed prior to any field tests specified in the specific equipment sections.

2. GENERAL. Equipment shall not be operated except by, or with the guidance of, qualified personnel having the knowledge and experience necessary to obtain proper results. All items of equipment and systems shall be tested for proper operation, efficiency, and capacity. All required adjustments, tests, operation checks, and other startup activity shall be provided by qualified personnel. Contractor shall be responsible for planning, supervising, and executing the installation of Work.

2.01. Coordination. Contractor shall coordinate all tests related to startup of equipment and systems and shall report the results to Engineer in accordance with the submittals section. Contractor shall accept the equipment and the test results related to starting of equipment and systems before Engineer will accept the equipment and the test results.

When equipment is ready for a witness test, Contractor shall give written notice to Engineer at least 14 days before any offsite witness testing is performed or any field witnessed performance testing, unless otherwise specified.

3. EQUIPMENT TESTS.

3.01. Factory Tests. When specified in the specific equipment sections, the equipment will be test run at the point of manufacture and the test results will be delivered to Engineer. Such equipment will not be shipped until Engineer has reviewed the test results and advised the Contractor, in writing, that the equipment is acceptable for shipment. Such acceptance, however, will not be considered as final acceptance, which will only be made on the basis of the test results of the equipment after installation.

3.02. Preliminary Field Tests. All items of mechanical equipment shall be given a preliminary field test by Contractor after installation for proper operation, efficiency, and capacity. The preliminary field test shall consist of the requirements listed herein, unless exceptions or additions are indicated in the specific equipment sections.

Contractor's test operation of each piece of mechanical equipment shall continue for not less than 8 hours without interruption. All moving parts of equipment and machinery shall be carefully tested for operation, and adjusted so all parts move freely and function to secure satisfactory operation. All equipment shall be tested continuously under actual or simulated operating conditions. All parts shall operate satisfactorily in all respects, under continuous full load and in accordance with the specified requirements, for the full duration of the 8 hour test period. If any part of a unit shows evidence of unsatisfactory or improper operation during the 8 hour test

period, correction or repairs shall be made and the full 8 hour test operation, as specified, shall be completed after all parts operate satisfactorily.

Tests of all process and pumping equipment, drive motors, including auxiliaries shall be made in accordance with the appropriate and approved test codes such as the American Society of Mechanical Engineers, Hydraulic Institute Standards, and IEEE.

Tests shall be conducted after the Work is substantially complete so each item of equipment is ready for integrated operation with other equipment at the plant. Testing, measuring, and calibrating procedures shall be submitted to Engineer for review and acceptance prior to startup and testing of equipment.

The equipment shall be properly filled, by Contractor, with oil and grease, and Contractor shall furnish all power, personnel, water, chemicals, fuels, oil, grease, and auxiliaries necessary for conducting the testing of the equipment for proper operation, efficiency, and capacity.

The period of inspection, initial startup operation, and field adjustment shall be as needed to achieve satisfactory installation and operation of the items furnished. Any period required for instruction of Owner's personnel shall be as specified in the Contract Documents.

When the specific equipment sections indicate that an installation check is required by the equipment manufacturer, the manufacturer's representative will make all necessary field adjustments and correct defects in materials or workmanship during this test period.

All equipment installed under this Contract, including that furnished by others, shall be placed into successful operation according to the written instructions of the equipment manufacturer and the instructions of the manufacturer's field representative.

3.03. Field System Operation Test. After all equipment is installed and the entire system is ready to operate, Contractor shall conduct a field system operation test. The test shall consist of the requirements listed herein, unless exceptions or additions are indicated in the specific equipment sections.

The test period shall be at least 7 days, and each system shall operate under actual or simulated operating conditions before a certificate of Substantial Completion of the Work is issued. All defects of material, workmanship, or equipment which appear during this test period shall be corrected by Contractor. After such corrections are made, the 7 day test shall be repeated before a certificate of Substantial Completion of Work is issued, unless waived by Engineer.

Contractor shall supply all power, water, oil, grease, auxiliaries, and operating personnel required for this operation test.

When necessary for certain items of equipment, the final adjustments and inspections will be made by factory trained service personnel (other than sales representatives), rather than by Contractor. The service personnel will also supervise the test operation. This requirement will be stated under the detailed specification for the particular piece or pieces of equipment. The

manufacturer's service personnel will make adjustments and supervise testing by Contractor until such tests have been accepted by Engineer.

4. ACCEPTANCE. When no other field tests for acceptance are specified in the equipment sections, at the end of the field system operation testing, each system will be accepted if, in the opinion of Engineer, it has operated satisfactorily without excessive power use, wear, or need for lubrication, or requiring undue attention; and if all its rotating parts operate without excessive vibration or noise at any operating condition.

When other field tests for acceptance are specified in the equipment sections, acceptance shall be after all tests are satisfactorily conducted as specified in the appropriate equipment procurement specification.

When a field performance test for baseline is specified in the equipment sections, acceptance shall be after a completion of the baseline performance test that is conducted as specified in the pumping unit field testing - baseline performance section.

Acceptance of Work in connection with the installation of equipment furnished by others will be subject to approval of the manufacturer's field representative.

Acceptance by Owner or approval of the manufacturer's field representative will not relieve Contractor of responsibility for defective Work.

End of Section

This page was left blank intentionally

PROJECT RECORD DOCUMENTS AND SAMPLES

PART 1-GENERAL

1.01 PURPOSE AND DESCRIPTION OF WORK

- A. The purpose of the Project Record Documents is to provide the County with factual information regarding all aspects of the Work, both concealed and visible, to enable future location, identification and modification of the Work without lengthy and expensive site measurement, investigation or examination.
- B. Maintenance, certification and submittal of Record Documents and Samples.
 - 1. Throughout progress of Work, maintain accurate records of progress and changes of Contract Documents and in the Record Drawings.
 - 2. Obtain the services of a Surveyor to certify the as-built asset attribute data for the location of the Work and transfer the data to the Record Drawings.
 - 3. Upon Surveyor certification of the location of completed work, transfer the information from the as-built asset attribute data to electronic record documents.
 - 4. Provide final record documents to the County.

1.02 DEFINITIONS

Except where specific definitions are used within a specific section, the following terms, phrases, words and their derivation shall have the meaning given herein when consistent with the context in which they are used. Words used in the present tense include the future tense, words in the plural number include the singular number and words in the singular number include the plural number. The word "shall" is mandatory, and the word "may" is permissive.

- A. **As-Built Asset Attribute Data:** Surveyor shall obtain field measurements of vertical and horizontal dimensions of constructed improvements so that the constructed facilities can be delineated in such a way that the location of the constructed improvements may be compared with the construction drawings. A completed table similar to the Table 01720-2 Asset Attribute Data Form Example in this Section shall be provided and certified by the Surveyor.
- B. **As-Built Drawings:** Drawings prepared by the Contractor's Surveyor shall depict the actual location of installed utilities for the completed WORK in a full size hard copy and an electronic AutoCAD file (dwg) format.
- C. **Boundary Survey:** Boundary survey, map and report certified by a Surveyor shall be provided that meets the requirements of Chapter 61G17-6 'Minimum Technical Standards', FAC.
- D. **Electronic As-Built Asset Attribute Data:** Shall mean documents that are signed and sealed electronically by a Surveyor by creating a "signature" file and are transmitted electronically following the procedures and definitions of Chapter 61G17-7.0025, FAC.

- E. **Record Documents:** Shall mean full size hard and electronic copies of Boundary Surveys and As-Built Asset Attribute Data certified by a Surveyor, reports and other documents presented in Article 2.01.
- F. **Surveyor:** Contractor's Surveyor that is licensed by the State of Florida as a professional surveyor and mapper pursuant to Chapter 472, F.S.
- E. **Survey Map Report:** As a minimum the Survey Map Report shall identify or describe the locations where the pipe centerline was constructed within three feet of the easement or right-of-way boundary, where the pipe was constructed outside the easement or right-of-way boundary, any corners that had to be reset, measurements and computations made, pump station boundary issues, and accuracies obtained.

1.03 RELATED REQUIREMENTS

- A. All General Conditions, Supplements to the General Conditions, and any Addenda issued by the County are a part of this Section in the same manner as if fully written herein, and shall govern the Work of this Section, except where more stringent articles or requirements are stipulated, then they shall govern this Section.
- B. The Contract Documents are complementary and what is required by anyone shall be as binding as if required by all.
- C. Other requirements affecting Project Record Documents may appear in pertinent other Sections of these specifications.

1.04 QUALITY ASSURANCE

- A. Delegate the responsibility for maintenance of the Record Documents to one person on the Contractor's staff as approved by the County.
- B. Thoroughly coordinate changes within the Record Documents, making adequate and proper entries on each page of specifications and each sheet of drawings and other documents where such entry is required to show progress and changes properly.
- C. Make entries within 24-hours after receipt of information has occurred.
- D. Survey documents shall comply with the minimum technical standards of Chapter 61G17-6 of the Florida Administrative Code (FAC) and Table 017201 Minimum Survey Accuracies specified in, whichever are more stringent. Asset attribute data shall be signed, sealed and dated by the Surveyor. All coordinates shall be geographically registered in the Florida State Plan Coordinate System using the contract drawings control points for horizontal and vertical controls.

Table 01720-1 Minimum Survey Accuracies

Asset/Location	Horizontal Accuracy (feet)	Elevation Accuracy (feet)	Location: horizontal center and vertical top, unless otherwise specified
Bench Marks	N/A	0.01	Point
Horizontal Control	0.01	N/A	Point
Easements and Tracts	*	N/A	Survey Monuments
Civil Site, Topo and Foundation Drawings	0.1	0.01	All
Hydrants	0.01	N/A	Operating Nut
Blow off Valves	0.01	N/A	Valve Enclosure
Air Release Valves	0.01	N/A	Valve Enclosure
Master Meters	0.01	N/A	Register
Meter Box	0.01	N/A	Top of Meter Box
Clean-out	0.01	N/A	Top of Clean-out
Pump Station	0.01	0.01	Top Center of Wet Well and Pipe Inverts
Manholes	0.01	0.1	Top Center of Cover
Manhole	N/A	0.01	Pipe Inverts
System Valves	0.01	0.1	Operating Nut and Valve Body
Fittings	0.01	0.1	Top of Fitting and Ground
Piping at 100' max intervals	0.01	0.1	Top of Pipe and Ground
Restrained Pipe	0.01	N/A	Limits
Connections	0.01	0.1	Pipe Invert
Bore & Jack Casing	0.01	0.1	Top of Casing at Limits of Casing
Existing Utilities**	0.01	0.1	Conflicts

* Shall conform to the requirements of the "Chapter 61G17-6, 'Minimum Technical Standards', FAC", certified by a Surveyor.

** Existing utilities including but not limited to water, wastewater, reclaimed water, storm, fiber optic cable, electric, gas and structures within the limits of construction.

1.05 SUBMITTALS

- A. Comply with pertinent provisions of Section 01300 “Submittals” and other submittal requirements in the different Articles of this Section and the rest of these specifications.
- B. As a prerequisite for progress payments, the CONTRACTOR shall exhibit the currently updated Record Documents for review by the COUNTY. Payment will be withheld at the COUNTY’S discretion based on the status of the Record Documents or if they are not properly maintained.
- C. The Work will not be placed into operation until the asset attribute data (see Table 01720 Asset Attribute Data Form Example) certified by the Surveyor for the Record Drawings is approved by the County.
- D. Prior to submitting request for final payment or the County issuing a Certificate of Completion for the Work, Contractor shall submit the final Record Documents to the County for approval. Retainage funds will be withheld at the County’s discretion based on the quality and accuracy of the final Record Documents.
- E. Required Submittal Documents:
 - 1. Full size, hard copy set of the Final Record Documents including but not limited to:
 - a. As-built asset attribute data added to the Record Drawings by the Contractor, boundary surveys of pump stations, Surveys and Survey Report for the location of constructed pipes within any easements and pump station site.
 - b. Other Final Record Documents.
 - 2. Digital Set of the Final Record Documents including but not limited to:
 - a. Scanned digital copies of the Record Drawings updated to match the as- asset attribute data table.
 - b. Electronic Survey documents electronically sealed by the Surveyor.
 - c. Final Record Documents information.
 - d. Digital Record Drawing in the Engineer’s current version of AutoCAD file (dwg) format for the Contract Drawings, updated to match the final Record Drawing information.

**Table 1720-2
Asset Attribute Data Form Example**

Asset Type	I.D. Number	Utilities Asset Number	UTILITIES Asset Coordinates		
			Northerly	Easterly	Elevation
Bench Marks	BM-1		1605466	450720.5	86.04
Horizontal control	HC-1		1605700	450879	N/A
Horizontal control	HC-2		1605333	450773.1	N/A
Fire hydrant	FH-1		1605630	450920.4	N/A
Fire hydrant	FH-2		1605162	450024.6	N/A
					Depth
Gate valve	GV-1		1605631	450533.2	2.9
Gate valve	GV-2		1605400	450765.8	3.4
Plug valve	PV-1		1605024	450123.7	3.3
Plug valve	PV-2		1605626	450245.4	2.6
Blow off valve	BO-1		1605805	450057.3	N/A
Blow off valve	BO-2		1605030	450126.2	N/A
Air release valve	ARV-W1		1605647	450939.9	N/A
Air release valve	ARV-FM2		1605978	450490.1	N/A
Master meter	MM-1		1605290	450130.2	N/A
Master meter	MM-2		1605900	450883.9	N/A
Detector check meter	DCM-1		1605244	450848.8	N/A
Detector check meter	DCM-2		1605829	450035.9	N/A
Clean-out	CO-1		1605290	450130.2	N/A
Clean-out	CO-2		1605900	450883.9	N/A
Force Main Fitting	FMF-1		1605024	450123.7	3.3
Water Main Fitting	WMF-1		1605626	450245.4	3.6
Reclaimed Water Fitting	RWMF-1		1605680	450302.7	3
Water Piping	WM-1		1605290	450130.2	2.8
Force Main Piping	FM-1		1605900	450883.9	4
Reclaimed Water Main Piping	RWM-1		1605900	450883.9	3.2

6. Partial Surveyor's as-built assets attribute data, pipe deflection data, and gravity main data.
- B. Maintain the documents and samples in an organized, clean, dry, legible condition and completely protected from deterioration and from loss and damage until completion of the Work, transfer of all record data to the final Record Documents and for submittal to the County.

PART 2-PRODUCTS

2.01 RECORD DOCUMENTS

- A. As-Built Drawings: After obtaining one complete set of all documents comprising the Contract and other Documents described in paragraph 1.06 Record Documents at site, the Contractor shall maintain and create the As-Built Drawings including:
1. Pump station site boundary survey and map report: Provide the pump station site boundary survey showing the real property boundaries and site improvements. The boundary survey field work and survey map shall be performed after the Work at the site has been completed and before the start-up inspection. Provide a survey map report in addition to the boundary survey.
 2. Survey Map Report for the As-Built Asset Attribute Data Table: As a minimum the Survey Map Report shall identify or describe the locations where the pipe centerline was constructed within three feet of the easement or right-of-way boundary, where the pipe was constructed outside the easement or right-of-way boundary, any corners that had to be reset, measurements and computations made, pump station boundary issues, and accuracies obtained. Survey map report shall be dated after the Work within the right-of-ways or easements have been completed.
 3. Surveyor shall obtain field measurements of vertical and horizontal dimensions of constructed improvements and certify a completed table similar to the Table 01720-2 Asset Attribute Data Form Example.
 4. Surveyor shall prepare a certified table to include as a minimum the pipe lengths, manhole inverts, and slopes for gravity mains.
 5. Surveyor shall calculate and prepare a certified table for horizontal and vertical pipe deflections of pipe that will include as a minimum the pipe lengths, coordinates of pipe deflections, horizontal or vertical deflections, the manufacturer's recommendations for pipe deflections, and meets or exceeds the manufacturer's recommendations.
- B. Final Record Documents: Contractor shall provide final version of the Record Documents both as paper copies and electronic format described below.
1. Construction Contract, Drawings, Specifications, General Conditions, Supplemental Conditions, Bid Proposal, Instruction to Bidders, Addenda, and all other Contract Documents.
 2. Change orders, verbal orders, and other modifications to Contract.
 3. Written instructions by the County as well as correspondence related to Requests for

Information (RFIs).

4. Accepted Shop Drawings, samples, product data, substitution and “or-equal” requests.
5. Field test records, inspection certificates, manufacturer certificates and construction photographs.
6. As-Built Drawings described in paragraph A. above.

PART 3-EXECUTION

3.01 MAINTENANCE AND CREATION OF AS-BUILT SET

- A. Promptly following the receipt of the County’s notice to proceed, secure from the County, at no charge to the Contractor, one (1) complete electronic set of construction drawings. Maintain the As-Built Drawings and create documents to add to it as described herein.
- B. Construction Progress Meetings
 1. Identify each paper document and sample with the title “RECORD DOCUMENTS” using one inch high letters or higher.
 2. Print a paper copy of the current draft electronic As-Built Drawings and As-Built Asset Attribute Data Table (all partially constructed improvements).
 3. Print a paper copy of the current table shall for pipe deflections (horizontal and vertical) depicting if the deflections meet the manufacturer’s recommendations.
 4. Print a paper copy of the current table of manhole elevations, pipe lengths, and slopes. The table shall be updated before progress meetings when the wastewater pipes that enter the manholes are backfilled.
- C. Survey Documents: Contractor shall obtain the services of a Surveyor to acquire the As-Built Assets Attribute Data, pump station Boundary Survey(s), and re-establish easement corners with pins if destroyed by the Work.
 1. Pump station site boundary survey and map report.
 2. Survey Map Report for the As-Built Asset Attribute Data Table.
 3. Complete a table similar to the Table 01720-2 Asset Attribute Data Form Example and the final table shall be certified by the Surveyor.
 4. Gravity main slope table prepared certified by Surveyor.
- D. Electronic As-Built Drawing Entries:
 1. Maintain the electronic As-Built Drawings to accurately record progress of Work and change orders throughout the duration of the Contract.
 2. Date all entries. Enter RFI No., Change Order No., etc. when applicable.
 3. Call attention to the entry by highlighting with a “cloud” drawn around the area affected.
 4. In the event of overlapping changes, use different colors for entries of the overlapping changes.
 5. Make entries in the pertinent other documents while coordinating with the Engineer and

the County for validity.

6. Entries shall consist of graphical representations, plan view and profiles, written comments, dimensions, State Plane Coordinates, details and any other information as required to document field and other changes of the actual Work completed. As a minimum, make entries to also record:
 - a. Specifications and Addenda: Record manufacturer, trade name, catalog number and supplier of each product and item of equipment actually installed as well as any changes made by Field Order, Change Order or other.
 - b. Depths of various elements of foundation in relation to finish floor datum and State Plane Coordinates and elevations.
 - c. Plan view and profile drawings, station and offset dimensions, State Plane coordinates for all fittings, valves and appurtenances of underground piping in the Work once lying uncovered in the trench. Show locations for equipment, facilities and other Work relocated or changed in the field.
 - d. When manholes, boxes, or underground conduits and plumbing are involved as part of the Work, record true elevations and locations, dimensions between manholes, slope of gravity mains, invert and top elevations.
 - e. Actually installed pipe or other Work materials, class, pressure rating, diameter, size, specifications, etc. Similar information for other encountered underground utilities, not installed by Contractor, their owner and actual location if different than shown in the Contract Documents.
 - f. Location of utilities, appurtenances and other Work concealed in the construction, referenced to visible and accessible permanent improvements.
 - g. Details, not on original contract Drawings, as needed to show the actual location of the Work completed in a manner that allows the County to find it in the future.
 - h. The Contractor shall mark all arrangements of conduits, circuits, piping, ducts and similar items shown schematically on the construction documents and show on the As-Built Drawings the actual horizontal and vertical alignments and locations.
 - i. Major architectural and structural changes including relocation of doors, windows, etc. Architectural schedule changes according to contractor's records and shop drawings.

E. Storage and Preservation:

1. Store Record Documents and samples at a protected location in the project field office apart from documents used for construction.
 - a. Provide files and racks for storage of documents
 - b. Provide locked cabinet or secure space for storage of samples.
2. File documents and samples in accordance with CSI format with section numbers matching those in the Contract Documents.
3. In the event of loss of recorded data, use means necessary to again secure the data to the County's approval.
 - a. Such means shall include, if necessary in the opinion of the County, removal and replacement of concealing materials.
 - b. In such cases, provide replacements of the concealing materials to the standards originally required by the Contract Documents.

3.02 FINAL RECORD DOCUMENTS SUBMITTAL

- A. Refer to Article 1.05 Submittals for relevant information regarding final submittal.
- B. Refer to Article 2.01 for relevant information for Final Record Documents.
- C. Scanned Documents: Scan the Survey Documents and other Record Documents reflecting changes from the Bid Documents.
 - 1. The scanned record drawing sets shall be complete and include the title sheet, plan/profile sheets, cross-sections, and details. Each individual sheet contained in the printed set of the As-Built Drawings shall be included in the electronic drawings, with each sheet being converted into an individual tif (tagged image file). The plan sheets shall be scanned in tif format Group 4 at 400 dpi resolution to maintain legibility of each drawing. Then, the tif images shall be embedded into a single pdf (Adobe Acrobat) file representing the complete plan set. Review all Record Documents to ensure a complete record of the project.
- D. Contractor's Surveyor shall review and check for accuracy the As-Built Drawings and ascertain that all data furnished and other documents are accurate and truly represent the Work as actually installed.
- E. As-Built Drawings: Provide an encompassing digital AutoCAD file that includes all the information of the Drawings and any other graphical information in the As-Built Drawings. It shall include the overall Work, utility system layout and associated parcel boundaries and easements. Feature point, line and polygon information for new or altered Work and all accompanying geodetic control and survey data shall be included. The surveyor's certified as-built asset attribute data shall be added to the As-Built Drawings and Surveyor shall electronically seal the data in a comma-delineated ASCII format (txt).
- F. Submit the Final Record Documents within 20 days after Substantial Completion.
- G. Participate in review meetings as required.
- H. Make required changes and promptly deliver the Final Record Documents to the Engineer and County

3.04 CHANGES SUBSEQUENT TO ACCEPTANCE

- A. The Contractor has no responsibility for recording changes in the Work after final completion, except for changes resulting from work performed under guarantee.

END OF SECTION

EQUIPMENT, PIPING, AND MATERIALS DEMOLITION

PART 1 - GENERAL

1-1. SCOPE

This section covers the demolition and removal of existing structures, equipment and piping. Items to be demolished and removed or salvaged at the pump station sites shall be as indicated on the drawings.

1-2. SUBMITTALS

Submit a removal and demolition plan to the Owner's on-site representative at least 60 days prior to scheduled removal and demolition work. Submittal shall be in accordance with Section 01300.

1-3. COORDINATION

Schedule a removal and demolition meeting with the Owner at least 30 days prior to scheduled removal and demolition work to review the plan and coordinate activities.

Following the coordination meeting, the Contractor shall provide notice of any planned demolition at least 14 days in advance of the planned commencement date. Notice shall be through the use of a Construction Assistance Request (CAR) form with information concerning the proposed commencement date and duration of the service outage. The Owner will provide the Contractor with a standard form to be used for this purpose. OWNER reserves the right to re-schedule any proposed demolition or service outage if it can not be reasonably accommodated when requested. Work shall not begin until approval is granted by OWNER.

1-4. PERMITS

The Contractor shall be responsible for obtaining all permits required for the demolition and disposal work.

PART 2 – MATERIALS - Not used.

PART 3 - EXECUTION

3-1. GENERAL

All facilities and materials to be demolished and salvaged shall be removed from the site unless otherwise noted on the drawings. Methods used in demolition and disposal of materials shall be in accordance with all codes, ordinances, and requirements of all

governing authorities; shall be acceptable to the Owner; and shall in all cases assure the safety of persons and property.

Existing surfaces to receive new materials or finishes shall be prepared accordingly. Surfaces exposed by demolition shall be finished to match adjacent surfaces if no additional work is scheduled or indicated.

Salvaged equipment shall be cleaned and delivered to the Owner at the Orange County Utilities Department Facility at Presidents Drive. Salvaged equipment shall be transported and stored on wood pallets with tie down straps.

3-2. EXISTING PIPING AND ELECTRICAL UTILITIES

Shut off or disconnect utilities affecting demolition work. Schedule shutdowns with the Owner; notify the Owner 14 working days in advance of any shutdown that is required to perform the work. The Owner will open/close valves on piping required for the shutdowns unless other arrangements are made during the coordination meeting.

3-3. ABANDONED AND UNUSED PIPING

A. All abandoned and unused piping both above grade and buried, shall be removed from the site, unless otherwise indicated on the drawings.

3-4. REMOVAL OF ELECTRICAL MATERIALS AND EQUIPMENT

A. Unless otherwise noted, remove all abandoned and unused electrical conduit, wiring, materials, and equipment from areas indicated for demolition. This includes, but is not limited to, all unnecessary buried power and control circuits. Disconnect circuits at their source. Remove exposed and buried conduits and materials no longer used, including conduit supports, anchors, studs, and straps. Remove or cut off concealed or embedded conduit, boxes, or other materials and equipment to a point at least 3/4 inch below the final finished surface.

B. Repair affected surfaces to conform to the type, quality, and finish of the surrounding surface.

3-5. BALLASTS

A. Electrical discharge lighting ballasts manufactured before 1974 that will be removed under this contract contain polychlorinated biphenyls (PCBs).

B. Electrical discharge lighting ballasts manufactured after 1973 may contain PCBs.

C. It is the Contractor's responsibility to identify the presence of PCBs and to dispose of them in compliance with all local, state, and federal laws, regulations, and ordinances.

3-6. TRANSFORMERS AND OTHER ELECTRICAL APPARATUS

Transformers, switches, capacitors, resistors, and/or other liquid-filled electrical apparatus that will be removed under this contract may contain PCBs. It is the Contractor's responsibility to identify the presence of PCBs and to dispose of them in compliance with all local, state, and federal laws, regulations, and ordinances.

3-7. PATCHING

- A. Patching shall mean the restoration of a surface or item to a condition as near as practicable to match the existing adjoining surfaces unless otherwise noted, detailed, or specified.
- B. When patching involves painting, special coating, vinyl fabric, or other applied finish, refinish the entire surface plane (i.e., wall or ceiling), unless complete refinishing of the entire space is scheduled or specified.
- C. Patching includes cleaning of soiled surfaces.

3-8. DEMOLITION

- A. Existing buildings, structures, boxes, pipes, pavements, curbs, and other items are to be removed and disposed of shall be as specified herein or as indicated on the drawings. Remove and dispose of all portions of these items which interfere with project construction.
- B. Remove from the site all facilities, in their entirety, to be demolished including belowground footings, foundations, and other associated appurtenances, as shown on the drawings or as specified herein. Backfill and compact all site areas disturbed by demolition work with earth backfill material in accordance with Section 02200. Sod shall be established in all disturbed areas in accordance with Section 02810.
- C. Perform the work in a manner that will not damage adjacent structures or facilities. If, in the opinion of the Owner, the method of demolition used may endanger or damage parts of the structure or affect the satisfactory operation of the facilities, Contractor must promptly change the method when so notified by the Owner's Representative. No blasting will be permitted.
- D. All equipment, material, and piping, except as specified to be salvaged for the Owner, or removed by others, within the limits of the demolition, excavations, and backfills, will become the property of the Contractor and shall be removed from the project site. The salvage value of this equipment, materials, and piping shall be reflected in the contract price of the demolition work.
- E. Material salvaged from demolition work shall not be reused as part of the work, except as specifically shown.

3-9. SCHEDULE

Certain items cannot be removed, abandoned, or demolished until certain other work has been accomplished. Contractor shall sequence work such that demolition will not have any impact on the pump station operations.

END OF SECTION

EARTHWORK

PART 1 - GENERAL

1-1. SCOPE. This section covers earthwork and shall include the necessary clearing, grubbing, and preparation of the site; removal and disposal of all debris; excavation; handling, storage, transportation, and disposal of all excavated material; all necessary sheeting, shoring, and protection work; preparation of sub-grades; pumping and dewatering as necessary; protection of adjacent property; backfilling; construction of fills and embankments; surfacing and grading; and other appurtenant work.

1-2. GENERAL. With reference to the terms and conditions of the construction standards for excavations set forth in OSHA "Safety and Health Regulations for Construction", Chapter XVII of Title 29, CFR, Part 1926, Contractor shall employ a competent person and, when necessary based on the regulations, a registered professional engineer, to act upon all pertinent matters of the work of this section.

1-3. SUBMITTALS. Drawings, specifications, and data covering the proposed materials shall be submitted in accordance with the Submittals section.

At least 30 days before starting construction on the sheeting and shoring, the sheeting and shoring design engineer shall complete and submit to Engineer the Protection System Design Certificate (Figure 1-02200) and the Contractor shall use the sheeting and shoring design. A separate certificate shall be submitted for each unique design. The certificate shall be signed and sealed by the registered professional engineer that designed the protection system. The professional engineer shall be licensed or registered in the state where the protection system is located.

1-3.01. Filter Fabric Data. Complete descriptive and engineering data for the fabric shall be submitted in accordance with the Submittals section. Data submitted shall include:

A 12 inch [300 mm] square sample of fabric.

Manufacturer's descriptive product data.

Installation instructions.

1-4. BASIS FOR PAYMENT.

1-4.01. Sheeting for Excavation of Structures. No additional payment above the Contract Price will be made for steel sheet piling left in place in excavations for structures.

1-5. INSURANCE. Professional Liability insurance shall be provided as specified in the Supplementary Conditions.

PART 2 - PRODUCTS

2-1. MATERIALS.

2-1.01. Filter Fabric. Filter fabric shall be provided in rolls wrapped with covering for protection from mud, dirt, dust, and debris.

2-1.01.01. Filter Fabric Type A. Filter Fabric Type A shall be provided for installation at locations indicated on the drawings and as specified herein. Filter fabric Type A shall be a non-woven fabric consisting of only continuous chains of polymeric filaments or yarns of polyester formed into a stable network by needle punching. The fabric shall be inert to commonly encountered chemicals; shall be resistant to mildew, rot, ultraviolet light, insects, and rodents; and shall have the indicated properties:

<u>Property</u>	<u>Test Method</u>	<u>Unit</u>	<u>Min Roll Value*</u>
Fabric Weight	ASTM D3776	oz/yd ² [g/m ²]	5.7 [193]
Grab Strength	ASTM D4632	lb [N]	155 [689]
Grab Elongation	ASTM D4632	percent	50
Mullen Burst Strength	ASTM D3786	psi [MPa]	190 [1.3]
Apparent Opening Size	CW-02215	U.S. Standard Sieve Size	70 [212 µm]

*Minimum average roll value in weakest principal direction.

2-1.01.02. Filter Fabric Type B. Not used.

2-1.01.03. Filter Fabric Type C. Not used.

2-1.02. Polyethylene Film. Polyethylene film beneath concrete slabs or slab base course material shall be Product Standard PS17, 6 mil minimum thickness.

2-1.03. General Fill and Embankment Materials. To the maximum extent available, excess suitable material obtained from structure and trench excavation shall be used for the construction of general fills and embankments. Additional material shall be provided from Contractor's off-site source. No borrow pits shall be opened on site unless such pits are specifically indicated on the drawings.

Fill material shall consist of non-plastic sand with less than 12 percent passing the No. 200 sieve. Silty sands may be used as fill provided the material's moisture content is adjusted to near optimum to achieve the specified degree of compaction. All material placed in fills and embankments shall be free from rocks or stones larger than the required size in their greatest dimension, brush, stumps, logs, roots, debris, and other organic or deleterious materials. The maximum size of stone in fills and embankment shall be 4 inches [100 mm]. No rocks or stones shall be placed in the upper 18 inches [450 mm] of any fill or embankment. Rocks or stones within the allowable size limit may be incorporated in the remainder of fills and embankments, provided they are distributed so that they do not interfere with proper compaction.

2-1.04. Granular Fill. Granular fill material shall be crushed rock or gravel suitable for use as a free draining sub-base beneath slabs and foundations. Granular fill shall be free from dust, clay, and trash; hard, durable, non-friable; and shall be graded 3/4 inch to No. 4 [19 to 4.75 mm] as defined in ASTM C33 for No. 67 coarse aggregate. Granular fill shall meet the quality requirements for ASTM C33 coarse aggregate. Only crushed rock with angular particles shall be used when the perimeter of the granular fill is not confined or otherwise subject to raveling, such as on a slope.

2-1.05. Structure Backfill. Structure backfill shall be defined as the material placed around and outside of structures. Structure backfill shall be as indicated herein.

2-1.05.01. General Fill Structure Backfill. General fill for structure backfill shall meet the requirements of the previous paragraph entitled "General Fill and Embankment Materials".

2-1.05.02. Crushed Rock Structure Backfill. At Contractor's discretion crushed rock as specified herein may be used for structure backfill. Crushed rock for structure backfill shall meet the following gradation requirements:

<u>Size</u>	<u>Percent Passing</u>
1/2 inch [12.5 mm]	100
3/8 inch [9.5 mm]	90 – 100
No. 4 [4.75 mm]	30 – 60
No. 8 [2.36 mm]	0 – 10
No. 200 [75 µm]	0 - 5

2-1.05.03. Clean Sand Structure Backfill. Not used.

2-1.06. Select Fill. Select fill shall be defined as the material placed beneath the structure foundations and slabs below any granular material layer or lean concrete slab indicated on the drawings. Select fill shall be used to replace any unsuitable material below the structure foundations and slabs and to raise the site grades below and within 5 feet of structural footprints and at locations indicated on the drawings. Select fill shall be as indicated herein.

2-1.06.01. General Fill Select Fill. General fill for use as select fill shall meet the requirements of the previous paragraph entitled "General Fill and Embankment Materials".

2-1.06.02. Crushed Rock Select Fill. At Contractor's discretion crushed rock as specified herein may be used for select fill. Crushed rock for select fill shall meet the following gradation requirements:

<u>Size</u>	<u>Percent Passing</u>
1/2 inch [12.5 mm]	100
3/8 inch [9.5 mm]	90 - 100

<u>Size</u>	<u>Percent Passing</u>
No. 4 [4.75 mm]	30 - 60
No. 8 [2.36 mm]	0 - 10
No. 200 [75 µm]	0 - 5

2-1.06.03. Clean Sand Select Fill. Not used.

2-1.07. Gravel Base Beneath Slabs. Not Used.

2-1.08. Controlled Low Strength Material (CLSM). Not used.

2-2. MATERIAL TESTING.

2-2.01. Preliminary Review of Materials. As stipulated in the Quality Control section, all tests required for preliminary review of materials shall be made by an acceptable independent testing laboratory at the expense of Contractor. Two initial gradation tests shall be made for each type of general fill, designated fill, backfill, or other material, and one additional gradation test shall be made for each additional 500 tons [450 Mg] of each material delivered to the jobsite. In addition, one set of initial Atterberg Limits test shall be made for each fill material containing more than 20 percent by weight pass the No. 200 sieve and for materials specified by Atterberg Limits. One additional Atterberg Limits test shall be made for each additional 500 tons [450 Mg] of each material delivered to the job site.

All material testing on CLSM shall be made by an independent testing laboratory at the expense of Contractor.

2-2.02. Field Testing Expense. All moisture-density (Proctor) tests and relative density tests on the materials, and all in-place field density tests, shall be made by an independent testing laboratory at the expense of Contractor. Contractor shall provide access to the materials and work area and shall assist the laboratory as needed in obtaining representative samples.

2-2.03. Required Field Tests. For planning purposes the following guidelines shall be used for frequency of field tests. Additional tests shall be performed as necessary for job conditions and number of failed tests. Test results shall be submitted as indicated in the Submittals section.

Two moisture-density (Proctor) tests in accordance with ASTM D698 (or, when required, ASTM D1557), or two relative density tests in accordance with ASTM D4253 and D4254 for each type of general fill, designated fill, backfill, or other material proposed.

For area fills and embankments, an in-place field density and moisture test for each 1000 cubic yards [764 m³] of material placed.

One in-place field density and moisture test for every 100 to 200 cubic yards [76 to 153 m³] of structure backfill or select fill.

Around manholes stagger tests within three feet of the structure's outside diameter. Perform first test one foot above the structure base. Perform second test two feet above the first test and perform subsequent tests every two feet up to finished grade.

One in-place density and moisture test whenever there is a suspicion of a change in the quality of moisture control or effectiveness of compaction.

At least one test for every full shift of compaction operations on mass earthwork.

Additional gradation, proctor, and relative density tests whenever the source or quality of materials changes.

Testing of CLSM shall be as follows.

Compressive Strength. For every 200 cubic yard [153 m³] of flowable fill placed, fill four 6 by 12 inch [150 by 300 mm] plastic cylinder molds to overflowing and then tap sides lightly. Cure cylinders in the molds covered until time of testing, at least 14 days. Strip the cylinders carefully using a knife to cut away the plastic mold. Cap the cylinders with high strength gypsum plaster or other capping process that will not break these low strength materials. Test cylinders in accordance with ASTM C39. Two cylinders shall be tested at 7 days and the other two cylinders shall be tested at 56 days.

Flow of Fill. Once each day that flowable fill is placed, test the fill material in accordance with ASTM C939 for the efflux time. Wet screening may be required to remove coarse particles.

Unit Weight and Yield. Once each day that flowable fill is placed, determine unit weight and yield in accordance with ASTM C138.

Air Content. Once each day that flowable fill is placed, determine air content in accordance with ASTM C231.

Penetration Resistance. Once each day that flowable fill is placed, determine early bearing strength in accordance with ASTM C403 penetration procedure.

PART 3 - EXECUTION

3-1. SITE PREPARATION. All sites to be occupied by permanent construction or embankments shall be cleared of all logs, trees, stumps, weeds, roots, brush, tree trimmings, rubbish, and other objectionable materials and debris. All stumps shall be grubbed. Grubbing shall consist of the complete removal of all stumps, roots larger than 1-1/2 inches in diameter, matted roots, brush, timber, logs and any other organic or metallic debris not suitable for foundation purposes, resting on, under or protruding through the surface of the ground to a depth of 18 inches below the subgrade or to a depth as designated by the Engineer. Subgrades for fills and embankments and sites to be occupied by permanent construction shall be cleaned and stripped of all surface vegetation, sod, and organic topsoil. All waste materials shall be removed from the site and disposed of by and at the expense of Contractor.

3-2. EXCAVATION.

3-2.01. General. Excavations shall provide adequate working space and clearances for the work to be performed therein and for installation and removal of concrete forms. In no case shall excavation faces be undercut for extended footings.

Sub-grade surfaces shall be clean and free of loose material of any kind when concrete is placed thereon.

Except where exterior surfaces are specified to be damp-proofed, monolithic concrete manholes and other concrete structures or parts thereof, which do not have footings that extend beyond the outside face of exterior walls, may be placed directly against excavation faces without the use of outer forms, provided that such faces are stable and also provided that a layer of polyethylene film is placed between the earth and the concrete.

Excavations for manholes and similar structures constructed of masonry units shall have such horizontal dimensions that not less than 6 inches [150 mm] clearance is provided for outside plastering.

3-2.02. Classification of Excavated Materials. No classification of excavated materials will be made for payment purposes. Excavation and trenching work shall include the removal and subsequent handling of all materials excavated or otherwise removed in performance of the work, regardless of the type, character, composition, or condition thereof.

3-2.03. Preservation of Trees. No trees shall be removed outside excavated or filled areas, unless their removal is authorized by Owner. Trees left standing shall be adequately protected from permanent damage by construction operations.

For limits of tree removal along pipeline routes, see the Temporary Facilities section under "Protection of Public and Private Property".

3-2.04. Unauthorized Excavation. Except where otherwise authorized, indicated, or specified, all materials excavated below the bottom of concrete walls, footings, slabs on grade, and foundations shall be replaced with concrete or lean concrete at the expense of Contractor. If structural concrete replacement is chosen, it shall be with concrete placed at the same time and monolithic with the concrete foundation.

3-2.05. Blasting. Blasting or other use of explosives for excavation will not be permitted.

3-2.06. Dewatering. Dewatering equipment shall be provided to remove and dispose of all surface water and groundwater entering excavations, trenches, or other parts of the work. Each excavation shall be kept dry during subgrade preparation and continually thereafter until the structure to be built, or the pipe to be installed therein, is completed to the extent that no damage from hydrostatic pressure, flotation, or other cause will result.

All excavations for concrete structures or trenches which extend down to or below groundwater shall be dewatered by lowering and keeping the groundwater level to the minimum depth of 24 inches [600 mm], beneath such excavations. The specified dewatering depth shall be maintained below the prevailing bottom of excavation at all times.

Surface water shall be diverted or otherwise prevented from entering excavations or trenches to the greatest extent possible without causing damage to adjacent property.

Contractor shall be responsible for the condition of any pipe or conduit used for drainage purposes, and all such pipe or conduit shall be left clean and free of sediment.

3-2.07. Sheeting and Shoring. Except where banks are cut back on a stable slope, excavations for structures and trenches shall be supported as necessary to prevent caving or sliding.

Steel sheet piling or other excavation support systems shall be furnished and installed as necessary to limit the extent of excavations for the deeper structures and necessary backfill under adjacent shallower structures, and to protect adjacent structures and facilities from damage due to excavation and subsequent construction. Contractor shall assume complete responsibility for, and install adequate protection systems for prevention of damage to existing facilities.

Excavation support systems and sheeting and shoring shall be all removed after completion of work. shall be removed or left in place at Contractor's discretion.

The design of the excavation support system shall be such as to permit complete removal while maintaining safety and stability in the excavation at all times.

Sheeting, shoring and excavation support systems shall be designed by a professional engineer registered in the state where the project is located.

3-2.08. Stabilization. Sub-grades for concrete structures shall be firm, dense, and thoroughly compacted and consolidated; shall be free from mud and muck; and shall be sufficiently stable to remain firm and intact under the feet of the workers.

Sub-grades for concrete structures which are otherwise solid, but which become mucky on top due to construction operations, shall be reinforced with crushed rock or gravel as specified for granular fills. The stabilizing material shall be placed in such a manner that no voids remain in the granular fill. All excess granular fill with unfilled void space shall be removed. The finished elevation of stabilized sub-grades shall not be above sub-grade elevations indicated on the drawings.

3-2.09. Ring-wall Excavation. Not used.

3-2.10. Roadway Excavation. Excavation for the roadways, drives, and parking areas shall conform to the lines, grades, cross sections, and dimensions indicated on the drawings and shall include the excavation of all unsuitable material from the subgrade. After shaping to line, grade, and cross section, the subgrade shall be compacted to a depth of at least 12 inches [300 mm] and shall meet the following:

Test method to determine maximum density and moisture.	ASTM D1557.
Relative compaction .	95%.
Moisture content relative to the optimum.	As required to achieve the

specified compaction

This operation shall include any reshaping and wetting or drying required to obtain proper compaction. All soft or otherwise unsuitable material shall be removed and replaced with suitable material.

3-3. **GENERAL FILLS AND EMBANKMENTS.** Fills and embankments not required or indicated to be designated fills shall be constructed as general fills and embankments. All fills and embankments shall be constructed to the lines and grades indicated on the drawings. Backfill materials shall be deposited in layers not to exceed 8 inches [200 mm] in uncompacted thickness. Unless otherwise specified herein, the following governing standards apply:

Test method to determine maximum density and moisture.	ASTM D1557.
Relative compaction and moisture content relative to the optimum.	95%.
Moisture content relative to the optimum.	As required to achieve the specified compaction

Backfilling and construction of fills and embankments during freezing weather shall not be done except by permission of Engineer. No backfill, fill, or embankment materials shall be installed on frozen surfaces, nor shall frozen materials, snow, or ice be placed in any backfill, fill, or embankment.

3-3.01. **Sub-grade Preparation.** After preparation of the fill or embankment site, the sub-grade shall be scarified and moisture conditioned to a minimum depth of 12 inches [300 mm], leveled and rolled so that surface materials of the sub-grade will be at a moisture content and as compact and well bonded with the first layer of the fill or embankment as specified for subsequent layers.

Unless otherwise directed by Engineer, the sub-grade shall be proof-rolled by a large vibratory roller (Dynapac CA-25 or equivalent). Extreme caution shall be exercised when operating vibratory equipment near existing structures to prevent damage to the structures. Provisions shall be made to monitor the adjacent structures for damaging vibrations. Rollers shall be operated in the static mode if excessive vibrations are experienced at the adjacent structures.

A minimum of 10 passes of the proof-rolling equipment shall be provided such that the last five passes are made perpendicular to the first five passes.

All soft, yielding, or otherwise unsuitable material shall be removed and replaced with compacted fill.

Proofrolling shall be continued until the soil at the depth of 12 inches below the compaction surface has attained a minimum of 95% of the maximum dry density per ASTM D1557.

3-3.02. **Placement and Compaction.** All fill and embankment materials shall be placed in approximately horizontal layers not to exceed 8 inches [200 mm] in un-compacted thickness.

Material deposited in piles or windrows by excavating and hauling equipment shall be spread and leveled before compaction.

Each layer of material shall have the best practicable moisture content for satisfactory compaction. The material in each layer shall be wetted or dried to achieve the moisture content relative to optimum as specified above, and shall be thoroughly mixed to ensure uniform moisture content and adequate compaction. Each layer shall be thoroughly compacted to the required degree of compaction at the required moisture content. If the material fails to meet the density specified, compaction methods shall be altered. The changes in compaction methods shall include, but not be limited to, changes in compaction equipment, reduction in uncompacted lift thickness, increase in number of passes, and better moisture control.

Wherever a trench is to pass through a fill or embankment, the fill or embankment material shall be placed and compacted to an elevation not less than 12 inches [300 mm] above the top of pipe elevation before the trench is excavated.

3-3.03. Borrow Pits. Borrow pits are not permitted at the project site.

3-4. DESIGNATED FILLS. Fills required or indicated to be designated fills shall be constructed using the specific materials and placement requirements as specified herein. In addition to the specific requirements specified herein, all requirements for general fills and embankments shall apply. These requirements include, but are not limited to organic or deleterious materials, subgrade preparation, lift thickness, and moisture conditioning requirements. All designated fills shall be constructed to the lines and grades indicated on the drawings. Backfilling and construction of fills during freezing weather shall not be done except by permission of Engineer. No backfill, fill, or embankment materials shall be installed on frozen surfaces, nor shall frozen materials, snow, or ice be placed in any backfill, fill, or embankment.

3-4.01. Granular Fill. Granular fills shall be provided where indicated on the drawings. Granular fills shall be placed on suitably prepared sub-grades in uncompacted lift thickness of 6 inches [150 mm] or less and compacted by vibration. Granular fills shall be compacted to not less than 70 percent relative density as determined by ASTM D4253 and D4254.

Where granular fills are to be covered with concrete, the top surface shall be graded to the required sub-grade elevation. The completed fill shall be covered by a vapor barrier.

3-4.02. Structure Backfill. Backfill materials shall be deposited in layers not to exceed 8 inches [200 mm] in uncompacted thickness and shall meet the following requirements:

Test method to determine maximum density and moisture.	ASTM D1557.
Relative compaction.	95%.
Moisture content relative to the optimum.	As required to achieve the specified compaction

Compaction of structure backfill shall be performed in such a manner that damage to the structure is prevented. The compaction equipment used within 8 feet [2.4 m] of the walls and for the top 8 feet [2.4 m] of backfill shall be the static type. Limit of equipment weight shall be 1 ton [907 kg]. Compaction of structure backfill by inundation with water will not be permitted.

No backfill shall be deposited or compacted in water.

Particular care shall be taken to compact structure backfill which will be beneath pipes, drives, roads, parking areas, walks, curbs, gutters, or other surface construction or structures. In addition, wherever a trench is to pass through structure backfill, the structure backfill shall be placed and compacted to an elevation not less than 12 inches [300 mm] above the top of pipe elevation before the trench is excavated. Compacted areas, in each case, shall be adequate to support the item to be constructed or placed thereon.

3-4.03 Select Fill. Select fill shall be placed in nearly horizontal layers in uncompacted lift thickness of 8 inches or less and shall meet the following requirements:

Test method to determine maximum density and moisture.	ASTM D1557.
Relative compaction.	95%.
Moisture content relative to the optimum.	As required to achieve the specified compaction

3-4.04. Gravel Base Beneath Slabs. Not Used.

3-4.05. Controlled Low Strength Material (CLSM) Fill. Not used.

3-4.06. Ringwall Fill. Not used.

3-5. STRUCTURE FOUNDATION PREPARATION.

3-5.01. Excavation. Excavation below proposed foundations and slabs-on-grade shall consist of removing all loose, soft or otherwise unsuitable material to the depths determined by Engineer. Excavation shall be performed using methods and equipment that prevent disturbance of the bearing materials. Should bearing materials become disturbed due to excavation operations, they shall be recompacted, removed or stabilized to produce a firm, dense and thoroughly compacted and consolidated subgrade to the satisfaction of Engineer.

3-5.02. Limits of Excavation. Excavations of unsuitable materials shall extend beyond the edge of the footing a distance equal to the depth of overexcavation below the bottom of the footing or 3 feet, whichever is greater. In no case, however, shall proposed excavations undermine existing foundations. Foundations and slabs of existing structures shall be positively supported by means suitable to prevent damage to structures.

Damage to existing structures as a result of the Contractor's operations shall be corrected by the Contractor to the satisfaction of Engineer at no additional cost to the Owner. The Contractor

shall adequately survey the condition of the structure in the work area and provide a written report to Engineer prior to excavation.

3-5.03. Subgrade Preparation. Prior to placing fills below footings and slabs and any filter fabric and granular fill or gravel as indicated on the drawings, the subgrade shall be tested for soft, loose, or unsuitable soils.

Subgrades to a depth of 24 inches below footings and slabs shall be compacted to at least 95 percent of the maximum dry density as determined by ASTM D1557. This requirement does not apply to the pump station structures designed to be constructed with a tremie concrete slab. For these structures the subgrade shall be natural undisturbed soils. All loose, disturbed materials shall be removed to the level of undisturbed materials.

Remove and replace the top 24 inches below the footings and slabs to meet the specified compaction.

3-5.05. Replacement Materials. Materials used to replace existing unsuitable materials shall meet the quality, classification and compaction requirements of select fill.

3-6. FINAL GRADING AND PLACEMENT OF TOPSOIL. After other outside work has been finished, and backfilling and embankments completed and settled, all areas which are to be graded shall be brought to grade at the indicated elevations, slopes, and contours. All cuts, fills, embankments, and other areas which have been disturbed or damaged by construction operations shall be surfaced with topsoil to a depth of 4 inches [100 mm]. Topsoil shall be of a quality at least equal to the existing topsoil in adjacent areas, free from trash, stones, and debris, and well suited to support plant growth.

Use of graders or other power equipment will be permitted for final grading and dressing of slopes, provided the result is uniform and equivalent to manual methods. All surfaces shall be graded to secure effective drainage. Unless otherwise indicated, a slope of at least 1 percent shall be provided.

Final grades and surfaces shall be smooth, even, and free from clods and stones, weeds, brush, and other debris.

3-7. DISPOSAL OF EXCAVATED MATERIALS. Suitable excavated materials may be used in fills and embankments as needed. All excess excavated material shall be disposed of off site at the expense of Contractor.

All debris, stones, logs, stumps, roots, and other unsuitable materials shall be removed from the site and disposed of by, and at the expense of, Contractor.

3-8. RESODDING. All established lawn areas cut by the line of trench, by excavation, or damaged during the work shall be resodded, after completion of construction, to the complete satisfaction of the property owner and Owner. All sod used shall be the same type as removed or damaged, shall be best quality, and, when placed, shall be live fresh growing grass with at least 1-1/2 inches [40 mm] of soil adhering to the roots.

All sod shall be procured from areas where soil is fertile and contains a high percentage of loamy topsoil and from areas that have been grazed or mowed sufficiently to form a dense turf.

Sod shall be transplanted within 24 hours from the time it is harvested, unless stacked at its destination in a suitable manner. All sod in stacks shall be kept moist and protected from exposure to the sun and from freezing. In no event shall more than 1 week elapse between cutting and planting.

Before placing sod, all shaping and dressing of the areas shall have been completed. After shaping and dressing, commercial fertilizer of a type acceptable to Owner shall be applied uniformly in the manner and amounts recommended by the manufacturer, and harrowed lightly. Sodding shall follow immediately.

All sodding shall be done during the period from March 15 to October 1, unless written permission is given by Owner to extend the planting season.

3-9. SETTLEMENT. Contractor shall be responsible for all settlement of backfill, fills, and embankments which may occur within the correction period stipulated in the General Conditions.

Contractor shall make, or cause to be made, all repairs or replacements made necessary by settlement within 30 days after notice from Engineer or Owner.

End of Section

**PROTECTIVE SYSTEM
DESIGN CERTIFICATE**

I undersigned engineer, hereby certify that the protection system for _____(structure name) has been designed by me and is in compliance with the Contract Documents.

Name: _____

State of Registration: _____

Signature: _____

P.E. Number _____

Date: _____

(Seal)

This page was left blank intentionally

TRENCHING AND BACKFILLING

PART 1 - GENERAL

1-1. SCOPE. This section covers clearing, grubbing, and preparation of the site; removal and disposal of all debris; excavation and trenching; tunneled (trenchless construction) crossings; the handling, storage, transportation, and disposal of all excavated material; all necessary sheeting, shoring, and protection work; preparation of subgrades; pumping and dewatering as necessary; protection of adjacent property; backfilling; pipe embedment; surfacing and grading; and other appurtenant work.

1-2. GENERAL. With reference to the terms and conditions of the construction standards for excavations set forth in OSHA "Safety and Health Regulations for Construction", Chapter XVII of Title 29, CFR, Part 1926, Contractor shall employ a competent person and, when necessary based on the regulations, a registered professional engineer, to act upon all pertinent matters of the work of this section.

1-3. SUBMITTALS. Drawings, specifications, and data covering the proposed materials shall be submitted in accordance with the Submittals section.

At least 30 days before starting construction on the sheeting and shoring, the sheeting and shoring design engineer shall complete and submit to Engineer the Protection System Design Certificate (Figure 2-02202) and the Contractor shall use the sheeting and shoring design. A separate certificate shall be submitted for each unique design. The certificate shall be signed and sealed by the registered professional engineer that designed the protection system. The professional engineer shall be licensed or registered in the state where the protection system is located.

1-3.01. Filter Fabric Data. Complete descriptive and engineering data for the fabric shall be submitted in accordance with the Submittals section. Data submitted shall include:

A 12 inch square [300 mm] sample of fabric.

Manufacturer's descriptive product data.

Installation instructions.

1-4. BASIS FOR PAYMENT.

1-4.01. Trench Sheeting. No additional payment above the Contract Price will be made for trench sheeting left in place.

1-5. INSURANCE. Professional Liability insurance shall be provided as specified in the Supplementary Conditions.

PART 2 - PRODUCTS

2-1. MATERIALS.

2-1.01. Filter Fabric. The fabric shall be provided in rolls wrapped with covering for protection from mud, dirt, dust, and debris.

2-1.01.01. Filter Fabric Type A. Filter fabric Type A shall be provided for installation at locations indicated on the drawings and as specified herein. Filter Fabric Type A shall be a nonwoven fabric consisting of only continuous chains of polymeric filaments or yarns of polyester formed into a stable network by needle punching. The fabric shall be inert to commonly encountered chemicals; shall be resistant to mildew, rot, ultraviolet light, insects, and rodents; and shall have the indicated properties:

<u>Property</u>	<u>Test Method</u>	<u>Unit</u>	<u>Minimum Average Roll Value *</u>
Fabric Weight	ASTM D3776	oz/yd2 [g/m2]	5.7 [193]
Grab Strength	ASTM D4632	lb [N]	155 [689]
Grab Elongation	ASTM D4632	percent	50
Mullen Burst Strength	ASTM D3786	psi [MPa]	190 [1.3]
Apparent Opening Size	CW-02215	U.S. Standard Sieve Size	70 [212 µm]

* Minimum average roll value in weakest principal direction.

2-1.01.02. Filter Fabric Type B. Not used.

2-1.02. Polyethylene Film. Polyethylene film beneath concrete slabs or slab base course material shall be Product Standard PS17, 6 mil [150 mm] minimum thickness.

2-1.03. Tunnel Liner Plates. Not used.

2-1.04. Smooth Steel Pipe. Not used.

2-1.05. Wood Skids. Not used.

2-1.06. Casing Insulators. Not used.

2-1.07. Stabilized Sand Backfill. Not used. Stabilized sand shall be mixed in the proportions of at least 282 lbs of Portland cement to each cubic yard of sand [167 kg of Portland cement to each cubic meter of sand]. Cement, sand (fine aggregate), and water shall be as specified for cast-in-place concrete.

2-1.08. End Closure. Not used.

2-1.09. Inundated Sand Fill. Sand fill shall be clean, with not more than 25 percent retained on a No. 4 [4.75 mm] sieve and not more than 7 percent passing a No. 200 [75 µm] sieve, and shall have an effective size between 0.10 and 0.30 mm.

2-1.10. Graded Gravel Fill. Graded gravel for compacted trench backfill shall conform to the following gradation:

<u>Sieve Size</u>	<u>Percent Passing by Weight</u>
1 inch [25 mm]	100
3/4 inch [19 mm]	85 – 100
3/8 inch [9.5 mm]	50 – 80
No. 4 [4.75 mm]	35 – 60
No. 40 [425 µm]	15 – 30
No. 200 [75 µm]	5 – 10

The gravel mixture shall contain no clay lumps or organic matter. The fraction passing the No. 4 [4.75 mm] sieve shall have a liquid limit not greater than 25 and a plasticity index not greater than 5.

2-1.11. Controlled Low Strength Material (CLSM) Fill. Not used.

2-1.12. Granular Fill. Granular fill material shall be crushed rock or gravel. Granular fill shall be free from dust, clay, and trash; hard, durable, non-friable; and shall be graded 3/4 inch to No. 4 [19 to 4.75 mm] as defined in ASTM C33 for No. 67 coarse aggregate. Granular fill shall meet the quality requirements for ASTM C33 coarse aggregate.

2-2. MATERIALS TESTING.

2-2.01. Preliminary Review of Materials. As stipulated in the Quality Control section, all tests required for preliminary review of materials shall be made by an acceptable independent testing laboratory at the expense of Contractor. Two initial gradation tests shall be made for each type of embedment, fill, backfill, or other material, and one additional gradation test shall be made for each additional 500 tons [450 Mg] of each material delivered to the site. In addition, one set of initial Atterberg Limits test shall be made for each fill materials containing more than 20 percent by weight passing the No. 200 sieve [75 :m]. One additional Atterberg Limits test shall be made for each additional 500 tons [450 Mg] of each material delivered to the site.

All material testing on CLSM shall be made by an independent testing laboratory at the expense of Contractor.

2-2.02. Field Testing Expense. All moisture-density (Proctor) tests and relative density tests on the materials, and all in-place field density tests, shall be made by an independent testing laboratory at the expense of Contractor. Contractor shall provide access to the materials and work area and shall assist the laboratory as needed in obtaining representative samples.

2-2.03. Required Tests. For planning purposes, the following guidelines shall be used for frequency of field tests. Additional tests shall be performed as necessary for job conditions and number of failed tests. Test results shall be submitted as indicated in the Submittals section.

- a. Two moisture density (Proctor) tests in accordance with ASTM D698 (or, when required, ASTM D1557), or two relative density tests in accordance with ASTM D4253 and D4254 for each type of general fill, designated fill, backfill, or other material proposed.
- b. In-place field density and moisture tests at intervals of 300 feet [90 m] maximum along the trench. Within the trench, perform one test at the pipe springline, at least one test for each 12-inch layer of backfill within the pipe zone for pipes 24 inches and larger, one test at an elevation of one foot above the top of the pipe, and one test for each two feet of backfill placed from one foot above the top of the pipe to finished grade elevation.
- c. One in-place field density and moisture test for every 200 cubic yards [153 m³] of backfill or one test for every 100 square feet of backfill, whichever criteria provides a higher number of tests.
- d. One in-place density and moisture test whenever there is a suspicion of a change in the quality of moisture control or effectiveness of compaction.
- e. At least one test for every full shift of compaction operations on mass earthwork.
- f. Provide additional field density and moisture testing prior to commencing further construction if the testing reports and inspection indicate that the fill that has been placed is below specified density. The Owner may require additional tests to certify the installation depending on field conditions.
- g. Additional gradation, Proctor, and relative density tests whenever the source or quality of material changes.

PART 3 - EXECUTION

3-1. CLEARING. All clearing shall be performed as necessary for access, stringing of pipeline materials, and construction of the pipeline and appurtenant structures.

3-2. EXCAVATION. Excavations shall provide adequate working space and clearances for the work to be performed therein and for installation and removal of concrete forms. In no case shall excavation faces be undercut for extended footings.

Subgrade surfaces shall be clean and free of loose material of any kind when concrete is placed thereon.

Except where exterior surfaces are specified to be damp-proofed, monolithic concrete manholes and other concrete structures or parts thereof, which do not have footings that extend beyond the outside face of exterior walls, may be placed directly against excavation faces without the use of outer forms, provided that such faces are stable and also provided that a layer of polyethylene film is placed between the earth and the concrete.

Excavations for manholes and similar structures constructed of masonry units shall have such horizontal dimensions that not less than 6 inches [150 mm] clearance is provided for outside plastering.

3-2.01. Classification of Excavated Materials. No classification of excavated materials will be made for payment purposes. Excavation and trenching work shall include the removal and subsequent handling of all materials excavated or otherwise removed in performance of the work, regardless of the type, character, composition, or condition thereof.

3-2.02. Preservation of Trees. No trees shall be removed outside excavated or filled areas, unless their removal is authorized by Owner. Trees left standing shall be adequately protected from permanent damage by construction operations.

For limits of tree removal along pipeline routes, see the Temporary Facilities section under "Protection of Public and Private Property".

3-2.03. Blasting. Blasting or other use of explosives for excavation will not be permitted.

3-2.04. Dewatering. Dewatering equipment shall be provided to remove and dispose of all surface water and groundwater entering excavations, trenches, or other parts of the work. Each excavation shall be kept dry during subgrade preparation and continually thereafter until the structure to be built, or the pipe to be installed therein, is completed to the extent that no damage from hydrostatic pressure, flotation, or other cause will result.

All excavations for concrete structures or trenches which extend down to or below groundwater shall be dewatered by lowering and keeping the groundwater level to the minimum depth of 24 inches [600 mm], beneath such excavations. The specified dewatering depth shall be maintained below the prevailing bottom of excavation at all times.

Surface water shall be diverted or otherwise prevented from entering excavations or trenches to the greatest extent possible without causing damage to adjacent property.

Contractor shall be responsible for the condition of any pipe or conduit which he may use for drainage purposes, and all such pipe or conduit shall be left clean and free of sediment.

Contractor shall obtain from the appropriate agencies and authorities, the dewatering and stormwater discharge permits required to remove and dispose of groundwater, surface water, and any other water used in Contractor's operations. The permits shall be obtained prior to start of construction.

3-2.05. Sheeting and Shoring. Except where banks are cut back on a stable slope, excavations for structures and trenches shall be supported with steel sheet piling and shoring as necessary to prevent caving or sliding.

Sheet piling or other excavation support systems shall be installed as necessary to limit the extent of excavations for deeper structures and to protect adjacent structures and facilities from damage due to excavation and subsequent construction. Contractor shall assume complete responsibility for, and shall install adequate protection systems for prevention of damage to existing facilities.

Sheeting, shoring and excavation support systems shall be designed by a professional engineer registered in the state where the project is located.

Trench sheeting may be removed if the pipe strength is sufficient to carry trench loads based on trench width to the back of sheeting. Trench sheeting shall not be pulled after backfilling. Where trench sheeting is left in place, it shall not be braced against the pipe, but shall be supported in a manner which will preclude concentrated loads or horizontal thrusts on the pipe. Cross braces installed above the pipe to support sheeting may be removed after pipe embedment has been completed. Trench sheeting shall be removed unless otherwise permitted by Engineer. Trench sheeting will not be removed, if in the opinion of Engineer, removal of the sheeting will cause damage to the facility it is protecting. If left in place, the sheeting shall cut off 12 inches below finished grade. The design of the support system shall be such as to permit complete removal while maintaining safety and stability at all times.

3-2.06. Stabilization. Sub-grades for concrete structures and trench bottoms shall be firm, dense, and thoroughly compacted and consolidated; shall be free from mud and muck; and shall be sufficiently stable to remain firm and intact under the feet of the workers.

Sub-grades for concrete structures or trench bottoms which are otherwise solid, but which become mucky on top due to construction operations, shall be reinforced with crushed rock or gravel as specified for granular fills. The stabilizing material shall be placed in a manner that no voids remain in the granular fill. All excess granular fill with unfilled void space shall be removed. The finished elevation of stabilized sub-grades shall not be above sub-grade elevations indicated on the drawings.

3-3. TRENCH EXCAVATION. No more trench shall be opened in advance of pipe laying than is necessary to expedite the work. One block or 400 feet [120 m], whichever is the shorter, shall be the maximum length of open trench on any line under construction.

Except where tunneling is indicated on the drawings, is specified, or is permitted by Engineer, all trench excavation shall be open cut from the surface.

3-3.01. Alignment, Grade, and Minimum Cover. The alignment and grade or elevation of each pipeline shall be fixed and determined from offset stakes. Vertical and horizontal alignment of pipes, and the maximum joint deflection used in connection therewith, shall be in conformity with requirements of the section covering installation of pipe.

Where pipe grades or elevations are not definitely fixed by the contract drawings, trenches shall be excavated to a depth sufficient to provide a minimum depth of backfill cover over the top of the pipe of ___ inchesmm over pipes below paved and graded streets and, of ___ inchesmm over pipes in other locations. Greater pipe cover depths may be necessary on vertical curves or to provide adequate clearance beneath existing pipes, conduits, drains, drainage structures, or other obstructions encountered at normal pipe grades. Measurement of pipe cover depth shall be made vertically from the outside top of pipe to finished ground or pavement surface elevation, except where future surface elevations are indicated on the drawings.

3-3.02. Maximum Trench Widths. Not used.

3-3.03. Minimum Trench Widths. Except when maximum trench width is required for certain conduits, trenches shall be excavated to the minimum trench widths indicated in the following table. Trenches shall be excavated to a width which will provide adequate working space and sidewall clearances for proper pipe installation, jointing, and embedment.

<u>Nominal Pipe Size</u>	<u>Minimum Trench Width</u>	<u>Clearance</u>
Less than 27 in [700 mm]	Pipe OD plus 24 in [600 mm]	12 in [300 mm]
27 in through 60 in [700 mm through 1,500 mm]	Pipe OD plus nominal pipe size	ID/2
Greater than 60 in [1,500 mm]	Pipe OD plus 70 in [1800 mm]	30 in [750 mm]

Clearance = Minimum sidewall clearance
 OD = Outside diameter (or span) of conduit
 ID = Inside diameter (or span) of conduit.

Specified minimum sidewall clearances are not minimum average clearances but are minimum clear distances which will be required to the trench excavation or the trench protective system.

Cutting trench banks on slopes to reduce earth load to prevent sliding and caving shall be used only in areas where the increased trench width will not interfere with surface features or encroach on right-of-way limits.

3-3.04. Mechanical Excavation. The use of mechanical equipment will not be permitted in locations where its operation would cause damage to trees, buildings, culverts, or other existing property, utilities, or structures above or below ground. In all such locations, hand excavating methods shall be used.

Mechanical equipment used for trench excavation shall be of a type, design, and construction, and shall be so operated, that the rough trench excavation bottom elevation can be controlled, and that trench alignment is such that pipe, when accurately laid to specified alignment, will be centered in the trench with adequate sidewall clearance. Undercutting the trench sidewall to obtain sidewall clearance will not be permitted.

In locations where maximum trench widths are required for designated rigid conduits, mechanical equipment shall be operated so that uniform trench widths and vertical sidewalls are obtained at least from an elevation 12 inches [300 mm] above the top of the installed pipe to the bottom of the trench.

3-3.05. Cutting Concrete Surface Construction. Cuts in concrete pavement and concrete base pavements shall be no larger than necessary to provide adequate working space for proper installation of pipe and appurtenances. Cutting shall be started with a concrete saw in a manner which will provide a clean groove at least 1-1/2 inches [40 mm] deep along each side of the trench and along the perimeter of cuts for structures.

Concrete pavement and concrete base pavement over trenches excavated for pipelines shall be removed so that a shoulder not less than 6 inches [150 mm] in width at any point is left between the cut edge of the pavement and the top edge of the trench. Trench width at the bottom shall not be greater than at the top and no undercutting will be permitted. Pavement cuts shall be made to and between straight or accurately marked curved lines which, unless otherwise required, shall be parallel to the center line of the trench.

Pavement removal for connections to existing lines or structures shall not exceed the extent necessary for the installation.

Where the trench parallels the length of concrete walks, and the trench location is all or partially under the walk, the entire walk shall be removed and replaced. Where the trench crosses drives, walks, curbs, or other surface construction, the surface construction shall be removed and subsequently replaced between existing joints or between saw cuts as specified for pavement.

3-3.06. Excavation Below Pipe Sub-grade. Except where otherwise required, pipe trenches shall be excavated below the underside of the pipe, as indicated on Figure 1-02202, to provide for the installation of granular embedment.

Bell holes shall provide adequate clearance for tools and methods used for installing pipe. No part of any bell or coupling shall be in contact with the trench bottom, trench walls, or granular embedment when the pipe is jointed.

3-3.07. Artificial Foundations in Trenches. Whenever unsuitable or unstable soil conditions are encountered, trenches shall be excavated below grade and the trench bottom shall be brought to grade with suitable material. In such cases, adjustments will be made in the Contract Price in accordance with the provisions of the General Conditions.

3-4. PIPE EMBEDMENT. Embedment materials both below and above the bottom of the pipe, classes of embedment to be used, and placement and compaction of embedment materials shall conform to the requirements indicated on Figure 1-02202 and to the following supplementary requirements.

Embedment material shall contain no cinders, clay lumps, or other material which may cause pipe corrosion.

3-4.01. Embedment Classes.

- a. Class A Arch Encasement. When arch encasement is indicated on the drawings, Class A arch encasement shall be used at all locations so indicated.
When arch encasement is not indicated on the drawings, Class A arch encasement is not required unless improper trenching or unexpected trench conditions require its use as determined by Engineer.
Concrete and reinforcing steel for Class A arch encasement shall conform to the requirements of the Cast-in-Place Concrete section.
- b. Class B Bedding. Class B bedding shall be used for all steel, ductile iron,

- pretensioned concrete and vitrified clay pipelines, and for all other pipelines not otherwise specified.
- c. Class B Special Bedding. Class B special bedding shall be used for HDPE, PVC, ABS, FRP, GRP, and when recommended by the pipe manufacturer.
 - d. Class C Bedding. Class C bedding shall be used for all reinforced concrete and prestressed concrete pipelines.

3-4.02. Embedment for Ductile Iron, Steel, FRP, and PVC Pipelines. Granular embedment for ductile iron, coal tar coated steel, FRP, and PVC pipelines shall be pea gravel or crushed rock with rounded or subrounded particles; crushed rock with sharp edges which could cause significant scratching or abrasion of the pipe or damage to the polyethylene tube protection shall not be used. Inundated sand may be used for granular embedment in locations where the use of water will cause no damage to adjacent property and where it can be placed and properly compacted without damage to the pipe.

Inundated sand for granular embedment shall be deposited in, or placed simultaneously with the application of water so that the sand is inundated during compaction. During placement, the sand shall be compacted with a mechanical probe type vibrator. Water shall be allowed to escape or shall be removed during vibration, and no ponding shall be allowed to take place. Inundated sand shall be compacted to 70 percent relative density as determined by ASTM D4253 and D4254. If the required density cannot be achieved, placement and compaction methods shall be altered.

3-4.03. Placement and Compaction. Granular embedment material shall be spread and the surface graded to provide a uniform and continuous support beneath the pipe at all points between bell holes or pipe joints. It will be permissible to slightly disturb the finished subgrade surface by withdrawal of pipe slings or other lifting tackle.

After each pipe has been graded, aligned, and placed in final position on the bedding material, and shoved home, sufficient pipe embedment material shall be deposited and compacted under and around each side of the pipe and back of the bell or end thereof by shovel slicing or other suitable methods to hold the pipe in proper position and alignment during subsequent pipe jointing and embedment operations.

Embedment material shall be deposited and compacted uniformly and simultaneously on each side of the pipe to prevent lateral displacement.

Class C embedment shall be compacted to the top of the pipe in all areas where compacted backfill is specified and also around the restrained pipe sections.

Each lift of granular embedment material shall be vibrated with a mechanical probe type vibrator or shovel sliced during placement to ensure that all spaces beneath the pipe are filled. Granular embedment shall be placed in maximum lift thickness of 6 inches [150 mm] and compacted. Each lift of embedment material shall be compacted with three passes (round trip) of a platform type vibrating compactor.

Where indicated on the drawings, migration of soil into the embedment material shall be prevented with filter fabric Type A or by use of inundated sand embedment. Filter fabric shall

be placed on the trench surfaces so that it completely surrounds the embedment material. Joints shall be lapped 12 inches [300 mm].

3-4.04. Groundwater Barrier. Continuity of embedment material shall be interrupted by low permeability groundwater barriers to impede passage of water through the embedment. Groundwater barriers for sewer lines that contain manholes with cast-in-place bases shall be compacted soil around each manhole, extending through any granular material beneath the manhole, and meeting ASTM D2487 soil classification GC, SC, CL, or ML-CL and shall be compacted to 92 percent of maximum density at near the optimum moisture content (ASTM D1557). Material may be finely divided, suitable job excavated material, free from stones, organic matter, and debris.

Groundwater barriers for sewer lines that contain manholes with precast (developed) bases and for all other pipelines shall be soil plugs of 3 feet [1 m] in width, extending the full depth and width of granular material, and spaced not more than 400 feet [120 m] apart. The soil plugs shall be constructed from soil meeting ASTM D2487 classification GC, SC, CL, or ML, and compacted to 92 percent of maximum density at near the optimum moisture content (ASTM D1557).

3-5. TRENCH BACKFILL. All trench backfill above pipe embedment shall conform to the following requirements.

A layer of backfill material not more than 8 inches [200 mm] deep may be placed over concrete arch encasement or concrete reaction blocking after the concrete has reached its initial set, to aid curing. No additional backfill shall be placed over arch encasement or blocking until the concrete has been in place for at least 3 days.

3-5.01. Compacted Backfill. Compacted backfill will be required for the full depth of the trench above the embedment in the following locations:

Where beneath pavements, surfacings, driveways, curbs, gutters, walks, or other surface construction or structures.

Where in street, road, or highway shoulders.

In established lawn areas.

The top portion of backfill beneath established lawn areas shall be finished with at least 12 inches [300 mm] of topsoil corresponding to, or better than that which is underlying adjoining lawn areas.

Trench backfill material shall be suitable job excavated material in undated sand graded gravel and shall be as specified herein.

3-5.01.01. Job Excavated Material. Job excavated material may be used for compacted backfill when the job excavated material is finely divided and free from debris, organic material, cinders, any corrosive material, and stones larger than 3 inches [75 mm] in greatest dimension. Masses of moist, stiff clay shall not be used. Job excavated materials shall be placed in uniform layers not exceeding 8 inches [200 mm] in uncompacted thickness. Each layer of material shall have

the best possible moisture content for satisfactory compaction. The material in each layer shall be wetted or dried as needed and thoroughly mixed to ensure uniform moisture content and adequate compaction. Increased layer thickness may be permitted for noncohesive material if Contractor demonstrates to the satisfaction of Engineer that the specified compacted density will be obtained. The method of compaction and the equipment used shall be appropriate for the material to be compacted and shall not transmit damaging shocks to the pipe. Job excavated material shall be compacted to 95 percent of maximum density at a moisture content within 2 percent of the optimum moisture content, as determined by ASTM D1557 when that test is appropriate, or to 70 percent relative density as determined by ASTM D4253 and D4254 when those tests are appropriate.

3-5.01.02. Inundated Sand. Sand shall be deposited in, or placed simultaneously with the application of, water so that the sand is inundated during compaction. During placement, the sand shall be compacted with a mechanical probe type vibrator. Water shall be allowed to escape or shall be removed during vibration and no ponding shall be allowed to take place. Inundated sand shall be compacted to 70 percent relative density as determined by ASTM D4253 and D4254.

3-5.01.03. Graded Gravel. Gravel backfill shall be deposited in uniform layers not exceeding 12 inches [300 mm] in uncompacted thickness. The backfill shall be compacted with a suitable vibratory roller or platform vibrator to at least 70 percent relative density as determined by ASTM D4253 and D4254.

Groundwater barriers specified under pipe embedment shall extend to the top of the graded gravel backfill.

3-5.02. Ordinary Backfill. Compaction of trench backfill above pipe embedment in locations other than those specified will not be required except to the extent necessary to prevent future settlement. Contractor shall be responsible for backfill settlement as specified.

Ordinary earth backfill material to be placed above embedments shall be free of brush, roots more than 2 inches [50 mm] in diameter, debris, cinders, and any corrosive material, but may contain rubble and detritus from rock excavation, stones, and boulders in certain portions of the trench depth.

Backfill material above embedments shall be placed by methods which will not impose excessive concentrated or unbalanced loads, shock, or impact on installed pipe, and which will not result in displacement of the pipe.

Compact masses of stiff clay or other consolidated material more than 1 cubic foot [0.03 m³] in volume shall not be permitted to fall more than 5 feet [1.5 m] into the trench, unless cushioned by at least 2 feet [600 mm] of loose backfill above pipe embedment.

No trench backfill material containing rocks or rock excavation detritus shall be placed in the upper 18 inches [450 mm] of the trench, nor shall any stone larger than 8 inches [200 mm] in its greatest dimension be placed within 3 feet [900 mm] of the top of pipe. Large stones may be placed in the remainder of the trench backfill only if well separated and so arranged that no interference with backfill settlement will result.

3-5.03. Water-Settled Earth Backfill. Settlement or consolidation of trench backfill using water jetting or ponding shall not be performed.

3-5.04. Structure Backfill. Backfill around manholes and small concrete vaults shall meet the requirements specified for structure backfill specified in Section 02200.

3-5.05. Controlled Low Strength Material (CLSM). Not used.

3-6. TUNNEL EXCAVATION. Not used.

3-7. DRAINAGE MAINTENANCE. Trenches across roadways, driveways, walks, or other trafficways adjacent to drainage ditches or watercourses shall not be backfilled prior to completion of backfilling the trench on the upstream side of the trafficway, to prevent impounding water after the pipe has been laid. Bridges and other temporary structures required to maintain traffic across such unfilled trenches shall be constructed and maintained by Contractor. Backfilling shall be done so that water will not accumulate in unfilled or partially filled trenches. All material deposited in roadway ditches or other watercourses crossed by the line of trench shall be removed immediately after backfilling is completed, and the original section, grades, and contours of ditches or watercourses shall be restored. Surface drainage shall not be obstructed longer than necessary.

3-8. PROTECTION OF TRENCH BACKFILL IN DRAINAGE COURSES. Not used.

3-9. FINAL GRADING AND PLACEMENT OF TOPSOIL. After other outside work has been finished, and backfilling and embankments completed and settled, all areas which are to be graded shall be brought to grade at the indicated elevations, slopes, and contours. All cuts, fills, embankments, and other areas which have been disturbed or damaged by construction operations shall be surfaced with topsoil to a depth of at least 4 inches [100 mm]. Topsoil shall be of a quality at least equal to the existing topsoil in adjacent areas, free from trash, stones, and debris, and well suited to support plant growth.

Use of graders or other power equipment will be permitted for final grading and dressing of slopes, provided the result is uniform and equivalent to manual methods. All surfaces shall be graded to secure effective drainage. Unless otherwise indicated, a slope of at least 1 percent shall be provided.

Final grades and surfaces shall be smooth, even, and free from clods and stones, weeds, brush, and other debris.

3-10. DISPOSAL OF EXCESS EXCAVATED MATERIALS. Disposal of excess material from trench excavations on plant and major facility construction sites shall be accomplished as indicated in the Earthwork section of the specifications for the major construction.

Disposal of excess material from other trench excavation sites shall be as follows. Except as otherwise permitted, all excess excavated materials shall be disposed of away from the site.

Broken concrete and other debris resulting from pavement or sidewalk removal, excavated rock in excess of the amount permitted to be installed in trench backfill, debris encountered in excavation work, and other similar waste materials shall be disposed of away from the site.

Excess earth from excavations located in unimproved property may be distributed directly over the pipe trench and within the pipeline right-of-way to a maximum depth of 6 inches [150 mm] above the original ground surface elevation at and across the trench and sloping uniformly each way. Material thus wasted shall be carefully finished with a drag, blade machine, or other suitable tool to a smooth, uniform surface without obstructing drainage at any point. Wasting of excess excavated material in the above manner will not be permitted where the line of trench crosses or is within a railroad, public road, or highway right-of-way. The disposal of waste and excess excavated materials, including hauling, handling, grading, and surfacing, shall be a subsidiary obligation of Contractor and no separate payment will be made therefore.

3-11. RESODDING. All established lawn areas cut by the line of trench or damaged during the work shall be re-sodded, after completion of construction, to the complete satisfaction of the property owner and Owner. All sod used shall be the same type as removed or damaged, shall be best quality, and, when placed, shall be live fresh growing grass with at least 1-1/2 inches [40 mm] of soil adhering to the roots.

All sod shall be procured from areas where soil is fertile and contains a high percentage of loamy topsoil and from areas that have been grazed or mowed sufficiently to form a dense turf.

Sod shall be transplanted within 24 hours from the time it is harvested, unless stacked at its destination in a suitable manner. All sod in stacks shall be kept moist and protected from exposure to the sun and from freezing. In no event shall more than 1 week elapse between cutting and planting.

Before placing sod, all shaping and dressing of the areas shall have been completed. After shaping and dressing, commercial fertilizer of a type acceptable to Owner shall be applied uniformly in the manner and amounts recommended by the manufacturer, and harrowed lightly. Sodding shall follow immediately.

All sodding shall be done during the period from March 15 to October 1, unless written permission is given by Owner to extend the planting season.

3-12. SETTLEMENT. Contractor shall be responsible for all settlement of trench backfill which may occur within the correction period stipulated in the General Conditions.

Contractor shall make, or cause to be made, all repairs or replacements made necessary by settlement within 30 days after notice from Engineer or Owner.

End of Section

This page was left blank intentionally

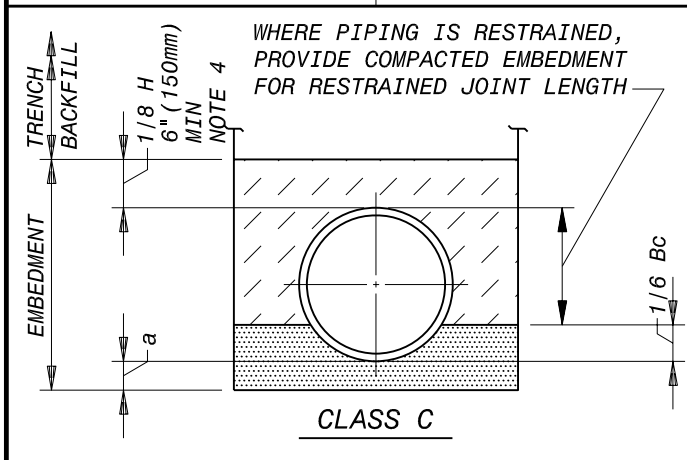
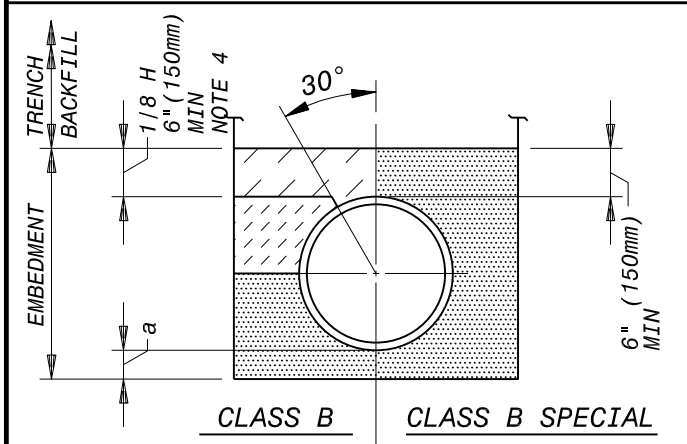
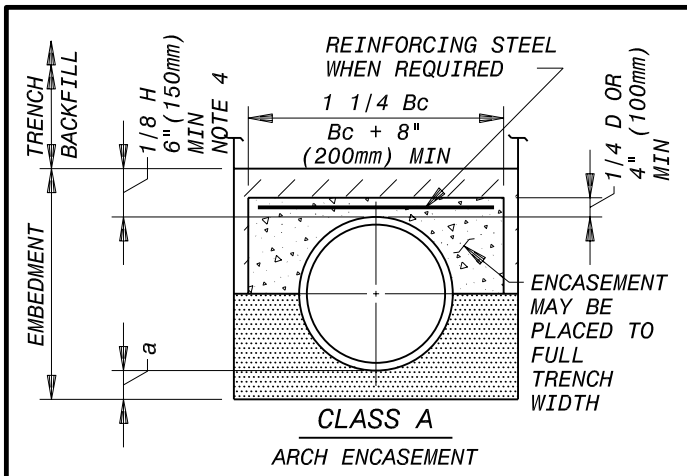

TABLE OF EMBEDMENT DEPTHS BELOW PIPE

D	a		a	
	MIN SOIL	MIN ROCK	MIN SOIL	MIN ROCK
	in	mm	in	mm
27" (675 mm) & SMALLER	3	75	6	150
30" (750 mm) TO 60" (1500 mm)	4	100	9	225
66" (1650 mm) & LARGER	6	150	12	300

NOTES:

1. GRANULAR EMBEDMENT MATERIAL SHALL BE CRUSHED ROCK OR PEA GRAVEL COARSE AGGREGATE SIZE NUMBER 7 (13 TO 4.75) ASTM C33. EMBEDMENT MATERIAL SHALL BE PLACED IN LAYERS NOT MORE THAN 6" (150mm) DEEP AND COMPACTED AS SPECIFIED.
2. HAND PLACED EMBEDMENT SHALL BE FINELY DIVIDED MATERIAL FREE FROM DEBRIS AND STONES.
3. COMPACTED EMBEDMENT SHALL BE FINELY DIVIDED JOB EXCAVATED MATERIAL FREE FROM DEBRIS, ORGANIC MATERIAL, AND STONES, PLACED IN UNIFORM LAYERS NOT MORE THAN 8" THICK, AND COMPACTED TO 95% MAXIMUM DENSITY AS DETERMINED BY ASTM D698; INUNDATED SAND; OR GRADED GRAVEL. GRANULAR EMBEDMENT MAY BE SUBSTITUTED FOR ALL OR PART OF THE COMPACTED EMBEDMENT.
4. EMBEDMENT ABOVE THE TOP OF THE PIPE SHALL BE AN UNCOMPACTED LAYER FOR ALL INSTALLATIONS.
5. REFER TO SPECIFICATIONS FOR GEOTECHNICAL FABRIC OR SPECIAL EMBEDMENT REQUIREMENTS FOR TRENCHES IN FINE SOILS EXTENDING BELOW GROUNDWATER LEVEL.
6. TRENCH OUTLINES DO NOT INDICATE ACTUAL TRENCH EXCAVATION SHAPE, SOIL CONDITIONS, OR PRESENCE OF SHEETING LEFT IN PLACE. EMBEDMENT MATERIAL SHALL EXTEND THE FULL WIDTH OF THE ACTUAL TRENCH EXCAVATION.
7. FOR RESTRAINED JOINT PIPE LENGTH WITH CLASS C EMBEDMENT THE BACKFILL ABOVE THE GRANULAR EMBEDMENT AND BELOW THE TOP OF THE PIPE SHALL BE COMPACTED EMBEDMENT.

LEGEND

- Bc OUTSIDE DIAMETER OF PIPE
- H COVER ABOVE TOP OF PIPE
- D NOMINAL PIPE SIZE
- a EMBEDMENT BELOW PIPE (SEE TABLE)

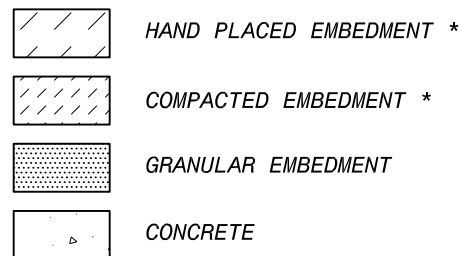

* OR GRANULAR EMBEDMENT

EMBEDMENTS FOR CONDUITS

BLACK & VEATCH

FIG 1-02202

This page was left blank intentionally

**PROTECTIVE SYSTEM
DESIGN CERTIFICATE**

I undersigned engineer, hereby certify that the protection system for _____(trench location) has been designed by me and is in compliance with the Contract Documents.

Name: _____

State of Registration: _____

Signature: _____

P.E. Number _____

Date: _____

(Seal)

THIS PAGE LEFT BLANK INTENTIONALLY

SEWER MANHOLES AND WETWELLS

PART 1 - GENERAL

1-1. SCOPE. This section covers the furnishing and installation of wetwells, and standard and drop sewer manholes. Wetwells, and standard and drop manholes shall be constructed complete with covers, fittings, and other appurtenances.

Where required, special manholes and wetwells shall be constructed in accordance with the details indicated on the drawings.

Frames and covers for structures other than sewer manholes are covered in the other sections. Access hatches for the wetwells are covered in Section 08305.

1-2. GENERAL. Standard and drop manholes shall be constructed with precast concrete (developed) bases; unless otherwise indicated on the drawings.

Only manholes which are required to have outside pipe and fittings for dropping sewage into the lower line will be designated as drop manholes. Inside drop manholes where the incoming line discharges directly into the manhole and which do not require special fittings will be considered standard manholes.

1-3. SUBMITTALS. Drawings and data covering precast concrete sections and castings shall be submitted in accordance with the Submittals section.

When corrosion protection systems are specified, data submitted shall include corrosion protection materials, method of application, maintenance requirements, and other pertinent data.

1-4. DELIVERY, STORAGE, AND HANDLING. Shipping shall be in accordance with the Shipping section. Handling and storage shall be in accordance with the Handling and Storage section.

Precast concrete sections shall not be delivered to the job until representative concrete control cylinders have attained a strength of at least 80 percent of the specified minimum.

Precast concrete sections shall be handled carefully and shall not be bumped or dropped. Hooks shall not be permitted to come in contact with joint surfaces.

PART 2 - PRODUCTS

2-1. MATERIALS.

Precast Concrete Manholes and
Wetwells and Reinforcement

ASTM C478, except as modified herein.

Cement

Cement type shall comply with ASTM C150, Type II. Water-cementitious materials ratio shall not exceed 0.40. Alternative materials proposed by Contractor that will provide equivalent corrosion protection and durability may be submitted subject to review and acceptance by Engineer.

Concrete Admixtures

Water proofing admixtures shall be utilized to prevent water intrusion in lieu of external coatings. Concrete admixtures shall be Xypex, Kryton, or approved equal. Admixture dosage rate shall be in accordance with the admixture supplier's recommendations based on the concrete's environmental exposure

Riser and Precast Base

Circular, uniform outside diameter.

Minimum Wall Thickness
for Manholes

1/12 of inside diameter, plus 1 inch.

Minimum Wall Thickness
for Wetwells (12 foot
diameter)

1/12 of inside diameter

Minimum Base Thickness
for Manholes

8 inches

Cone

Shape shall be concentric or eccentric as required; wall thickness as specified for riser sections.

Adjusting Rings

Circular, with shear keys.

Cast-in-Place Concrete Bases

Materials, handling, forms, finishing, curing, and other work as specified in the cast-in-place concrete section.

Nonshrinking Grout

Grace "Supreme", L&M "Crystex", Master Builders "Masterflow 713 Grout" or "Set Grout", Sauereisen Cements "F-100 Level Fill Grout", UPCO "Upcon Super Flow", or Five Star Products "Five Star Grout".

Resilient Manhole/Pipe Connectors

ASTM 923, A-Lok "Manhole Pipe Seal", Press-Seal "Manhole Connectors", or approved equal.

Mastic Fill	Butyl rubber compatible with resilient connector material.
Gaskets	
Mastic	ASTM C990; Hamilton-Kent "Kent-Seal No. 2", Sheller-Globe "Tac-Tite", or Henry Company "Ram-Nek" or approved equal. Cross-sectional area as recommended by manhole manufacturer.
Rubber	ASTM C361, Section 6.9.1, except gasket shall be synthetic, with hardness of 40 ± 5 when measured by ASTM D2240, Type A durometer. Natural rubber will not be acceptable.
Rubber Joint Filler	Synthetic.
Hardness	40 ± 5 when measured by ASTM D2240, Type A durometer.
Tensile Strength	1,200 psi minimum.
Corrosion Protection System	As specified herein.
Castings	ASTM A48, Class 35B or better.
Manhole Rings and Covers	US Foundry "USF 225-AS", Vulcan, or approved equal.
Manhole Top Encapsulation System	ANSI/AWWA C216, Canusa "WrapidSeal" Manhole Encapsulation System.

2-2. MANUFACTURE. The first riser sections for use with cast-in-place bases shall be provided with horseshoe-shaped boxouts for connecting piping to be grouted in, or with circular openings with continuous, circular, resilient connectors cast into the riser wall. Boxouts for grouting, if used, shall have surfaces grooved or roughened to improve grout bond.

Precast base sections shall be provided with circular openings, with continuous, circular, resilient connectors cast into the wall.

Resilient connectors shall be installed in accordance with the manufacturer's recommendations, except that connectors shall be positioned so that sealing or resealing operations may be accomplished from inside the manhole.

Precast sections may be provided with lifting notches on the inside faces of walls to facilitate handling. Lifting notches shall be not more than 3 inches deep; holes extending through the wall will not be acceptable.

If precast concrete base sections are used, part of the concrete invert fill may be furnished with the precast unit; however, a rough surface shall be provided to improve bond with the final invert fill. At least the top 2 inches of the concrete invert fill shall be installed in the field.

2-3. INTERIOR CORROSION PROTECTION SYSTEM. A corrosion protection system shall be applied to the interior surfaces of the manhole and wetwell. The corrosion protection system shall adequately protect the concrete from corrosion caused by exposure to hydrogen sulfide. Information regarding the proposed corrosion protection system shall be submitted to Engineer for review and acceptance. All new wetwells and manholes shall be lined. Any existing wetwells and manholes shall be coated with approved interior surface coatings

2-3.01. Manhole Interior.

Corrosion protection systems shall be as follows:

Surface Coatings - Interior

1. Sauereisen "210"
2. Aquata Poxy
3. Permite "PCA-9043 Type II"
4. Quadex "Alumina Liner"
5. THO ROC "HBS 100 Epoxy Liner System"
6. Lafarge Aluminates "Sewpercoat"
7. CCI Spectrum, Inc. "Spectrashield"

2-3.02. Wetwell Liners.

2-3.02.01 Fiberglass Liners.

Fiberglass reinforced polyester wetwell liner shall be manufactured from commercial grade polyester resin or vinyl ester resin with fiberglass reinforcements. The resin system shall be suitable for atmospheres containing hydrogen sulphide and dilute sulphuric acid, as well as other gases associated with the wastewater collection systems. The wetwell liner shall be a one-piece unit manufactured in accordance with the requirements of ASTM D3753. All inserts and sleeves for piping shall be in accordance with the liner manufacturer's recommendations and shall result in complete coverage of all pre-cast sections and be capable of passing a spark test.

2-3.02.02 HDPE Liner.

The HDPE embedment sheeting shall be mechanically bonded to the concrete by integral studs. The liner shall be cast in place by the precast manufacturer and the CONTRACTOR shall field weld the joints. Minimum thickness of liner is 80 mils. All inserts and sleeves for piping shall be in accordance with the liner manufacturer's recommendations and shall result in complete coverage of all pre-cast sections and be capable of passing a spark test.

2-3.02.03 Wetwell Lining Systems.

1. GU Liner – Reinforced Plastic Liner
2. AGRU Liner – HDPE Liner

3. Flowtite Liners – Fiberglass Liner
4. GSE Studliner – HDPE Liner
5. L&F Manufacturing – Fiberglass Liner
6. AFE – Fiberglass Liner

PART 3 - EXECUTION

3-1. INSPECTION. Precast concrete sections shall be inspected when delivered and all cracked or otherwise visibly defective units shall be rejected.

3-2. CONSTRUCTION.

3-2.01. Bases. If cast-in-place concrete bases are used, concrete shall be placed on undisturbed earth in accordance with applicable requirements of the Concrete section.

If precast concrete (developed) bases are used, the subgrade materials shall be excavated to undisturbed earth and to a uniform elevation which will permit at least 4 inches of granular embedment material, as specified in the Earthwork section, to be installed and compacted. The surface of the granular material shall be carefully graded and the base section accurately set so that connecting pipes will be on proper line and grade. The elevation of the granular material shall be adjusted until proper grade and alignment of the base section has been attained.

No wedging or blocking under precast concrete bases will be permitted.

When resilient connectors are used with cast-in-place bases, the concrete fill under the connecting pipe outside the manhole shall be deleted and shall be replaced with granular embedment material to undisturbed earth.

In no case shall the invert section through a manhole be greater than that of the outgoing pipe. The shape of the invert shall conform exactly to the lower half of the pipe it connects. Side branches shall be connected with a radius of curve as large as practicable. All inverts shall be towelled to a smooth, clean surface.

3-2.02. Riser and Cone Sections and Precast Concrete Adjusting Rings. Circular precast sections and rings shall be provided with a rubber or mastic gasket to seal joints between sections and rings. Mastic gaskets shall be used only at temperatures recommended by the manufacturer. Lifting notches in manhole and wetwell walls shall be filled with nonshrinking grout.

3-2.03. Connecting Piping. The space between connecting pipes and the wall of precast sections shall be completely filled with nonshrinking grout, except where resilient connectors are provided.

When resilient connectors are used, the connecting pipe shall be carefully adjusted to proper line and grade, and the bedding material shall be compacted under the haunches and to the spring line of the pipe for a distance of at least 6 feet from the manhole wall and to at least the minimum trench width. The pipe shall be installed in the resilient connector prior to backfilling outside the

manhole and shall be resealed after completion of the manhole and backfill. All visible leakage shall be eliminated.

The connecting pipe for installation with resilient connectors shall be plain-end, square cut spigots and shall not protrude more than 1 inch inside the manhole wall. A clear distance of at least 1 inch from the end of each connecting pipe and around the pipe shall be provided when the concrete invert fill is installed. After completion of the manhole, the boxout shall be filled with mastic filler material, completely filling the space beneath the pipe and extending to at least the spring line. The filler material shall provide a smooth, uniform surface between the inside diameter of the pipe and the manhole invert.

At each special manhole, rubber joint filler shall be provided around connecting piping. The filler shall be securely fastened in place with suitable wires or straps.

3-3. EXTERIOR COATING. Not Used.

3-4. CASTING COATING. Not Used

3-5. STUBS. Not used.

3-6. CONCRETE ADMIXTURES. Water proofing admixtures shall be utilized to prevent water intrusion in lieu of external coatings. Concrete admixtures shall be Xypex, Kryton, or approved equal. Admixture dosage rate shall be in accordance with the admixture supplier's recommendations based on the concrete's environmental exposure.

End of Section

POLYVINYL CHLORIDE (PVC) SEWER PIPE

PART 1 - GENERAL

1-1. SCOPE. This section covers furnishing polyvinyl chloride (PVC) gravity sewer pipe and fittings, complete with all jointing materials and appurtenances. Ribbed pipe or open profile pipe will not be acceptable.

Pipe trenching, bedding, and backfilling are covered in the Trenching and Backfilling section.

1-2. SUBMITTALS. Drawings and data shall be submitted in accordance with the Submittals section. Drawings and data shall include, but shall not be limited to, the following:

Details of joints.

Gasket material.

Pipe length.

Certification in accordance with ASTM D3034, Section 11; ASTM F679, Section 10; ASTM F1803, Section 12.

1-3. DELIVERY, STORAGE AND HANDLING. Shipping shall be in accordance with the Shipping section. Handling and storage shall be in accordance with the Handling and Storage section.

Pipe, fittings, and accessories shall be handled in accordance with Chapter 6 of AWWA Manual M23, to ensure installation in sound, undamaged condition. Pipe shall not be stored uncovered in direct sunlight.

PART 2 - PRODUCTS

2-1. MATERIALS.

Pipe and Fittings.

Solid wall 4 through 15 inches. ASTM D3034, Cell Classification 12454. SDR 35 for depth of cut greater than 4 ft and less than 12 ft; SDR 26 for any depth.

18 through 60 inches. ASTM F1803, or ASTM F679, Wall T-1, Cell Classification 12454. SDR 35 for depth of cut greater than 4 ft and less than 12 ft; SDR 26 for any depth.

Jointing Materials.

Bell-and-Spigot Joints.	ASTM D3212, integral bell push-on type elastomeric gasket joints.
Gaskets.	ASTM F477, synthetic rubber. Natural rubber will not be acceptable.
Field-Cut Joints and Connections to Other Piping Materials.	Fernco "Flexible Couplings" or Mission "Eastern Standard Band-Seal Couplings" with stainless steel shear rings.

PART 3 - EXECUTION

3-1. INSTALLATION AND TESTING. Pipe will be installed and tested in accordance with Section 02702.

End of Section

POLYVINYL CHLORIDE (PVC) PRESSURE PIPE

PART 1 - GENERAL

1-1. SCOPE. This section covers the furnishing and installation of 4 through 30 inch buried polyvinyl chloride (PVC) pressure pipe for force mains. PVC pressure pipe shall be furnished complete with all fittings, jointing materials, anchors, blocking, encasement, and other necessary appurtenances.

Pressure and leakage tests, cleaning, and disinfection, are covered in other sections. Pipe trenching, bedding, and backfill are covered in the Trenching and Backfilling section.

Pipe shall be furnished where indicated in the pipeline schedule or where indicated on the drawings.

1-2. GOVERNING STANDARDS. Except as modified or supplemented herein, all PVC pressure pipe shall conform to the applicable requirements of ANSI/AWWA C900 and C905.

The supplementary information required in the governing standards is as follows:

Affidavit of Compliance	Required.
Plant Inspection	Not required.
Special Markings	Not required.
Special Preparation for Shipment	Not required.
Certification	Required.

1-3. SUBMITTALS. Drawings and data shall be submitted in accordance with the Submittals section. Drawings and data shall include, but shall not be limited to, the following:

Gasket material.

Pipe length.

Affidavit of Compliance (ANSI/AWWA C900, Sec. 6.3).

Affidavit of Compliance (ANSI/AWWA C905, Sec. 6.3).

Certification (ANSI/AWWA C900, Sec. 4.2.3).

Certification (ANSI/AWWA C905, Sec. 4.2.3).

1-4. DELIVERY, STORAGE AND HANDLING. Shipping shall be in accordance with the Shipping section. Handling and storage shall be in accordance with the Handling and Storage section.

Pipe, fittings, and accessories shall be handled in accordance with Chapter 6 of AWWA Manual M23, to ensure installation in sound, undamaged condition. Pipe shall not be stored uncovered in direct sunlight.

PART 2 - PRODUCTS

2-1. DIMENSIONS. The dimension ratios (DRs: outside diameter to wall thickness) of PVC pressure pipe shall be as indicated in the PVC Pressure Pipe Schedule 02630-S01.

2-2. MATERIALS.

Pipe	ANSI/AWWA C900 or C905 minimum 100 psi working pressure rating; cast iron pipe OD, dimension ratio as specified herein.
Fittings	Cast iron; ANSI/AWWA C110/A21.10, 250 psi pressure rating, except shorter laying lengths will be acceptable.
Joints	
PVC to PVC	ANSI/AWWA C900 or C905, stab type, with elastomeric synthetic rubber gaskets. Gaskets of natural rubber will not be acceptable.
PVC to Cast Iron	ANSI/AWWA C111/A21.11, except gaskets shall be synthetic rubber. Natural rubber will not be acceptable.
Tapping Saddles	Ductile iron, with galvanized steel straps and synthetic rubber sealing gasket, 250 psi pressure rating.
Restrained Joints	ASTM F1674, EBAA Iron 2000 PV series (4 inch through 24 inch), Star Pipe Products "Stargrip" Series 4000, Ford Uniflange Series 1500, or approved equal.
Tapping Sleeves	Ductile iron, 250 psi pressure rating.

Manufacturing quality control shall be maintained by frequent, regularly scheduled sampling and testing. Testing shall comply with the governing standards.

2-3. SHOP COATING AND LINING. The exterior surfaces of cast iron fittings shall be coated with a bituminous coating. The interior surfaces of cast iron fittings shall be lined in accordance with the Ductile Iron Pipe section.

PART 3 - EXECUTION

3-1. INSPECTION. Pipe and fittings shall be carefully examined for cracks and other defects immediately before installation; spigot ends and bells shall be examined with particular care. All defective pipe and fittings shall be removed from the site of the work.

3-2. LAYING PIPE. Pipe shall be protected from lateral displacement by pipe embedment material installed as specified in the Trenching and Backfilling section. Pipe shall not be laid in water or other unsuitable conditions.

Pipe shall be laid with bell ends facing the direction of laying, except when reverse laying is specifically permitted by Engineer.

Foreign matter shall be prevented from entering the pipe during installation.

Whenever pipe laying is stopped, the open end of the line shall be sealed with a watertight plug. All water shall be removed from the trench prior to removing the plug.

3-2.01. Cleaning. The interior of all pipe and fittings shall be thoroughly cleaned before installation and shall be kept clean until the work has been accepted.

3-2.02. Alignment. Piping shall be laid to the lines and grades indicated on the drawings. Pipelines or runs intended to be straight shall be laid straight. Deflections from a straight line or grade shall not exceed the maximum deflections specified by the manufacturer.

Unless otherwise specified or indicated on the drawings, and subject to acceptance by Engineer, either shorter pipe sections or fittings shall be installed as required to maintain the indicated alignment or grade.

3-2.03. Locating Wire. Locating wire, for electronically locating pipe after it is buried, shall be attached along the length of and installed with the pipe. This is applicable to all sizes and types of pressure mains. The tracing wire is to be attached to the pipe with nylon wire ties, as shown on the Drawings. The wire itself shall be 10-gauge single strand solid core copper wire with non-metallic insulation. The insulation shall be color coded for the type of pipe being installed. Continuous continuity must be maintained in the wire along the entire length of the pipe run. Permanent splices must be made in the length of the wire using wire connectors approved for underground applications as listed in the uniform electric code handbook. The wire shall extend to the surface and be connected to a test station box at valve locations in the manor, as shown on the Drawings.

3-3. CUTTING PIPE. Cutting shall comply with the pipe manufacturer's recommendations and with Chapter 7 of AWWA Manual M23. Cuts shall be smooth, straight, and at right angles to the pipe axis. After cutting, the end of the pipe shall be dressed to remove all roughness and sharp corners and shall be beveled in accordance with the manufacturer's instructions.

3-4. JOINTS. Joints shall be stab-type unless otherwise indicated on the drawings.

3-4.01. Stab Type Joints. Jointing shall conform to the instructions and recommendations of the pipe manufacturer. All surfaces for gasketed joints shall be lubricated immediately before the joint is completed. Gaskets and lubricants shall be supplied by the pipe manufacturer, shall be suitable for use in potable water, shall be compatible with the pipe materials, shall be stored in closed containers, and shall be kept clean. Each spigot shall be suitably beveled to facilitate assembly.

3-4.02. Mechanical Joints. Mechanical joints shall be carefully assembled in accordance with the manufacturer's recommendations. If effective sealing is not obtained, the joint shall be disassembled, thoroughly cleaned, and reassembled. Over-tightening of bolts to compensate for poor installation practice will not be permitted.

3-5. POLYETHYLENE ENCASEMENT. Not used.

3-6. CONNECTIONS WITH EXISTING PIPING. Connections with existing pipes shall be made using fittings suitable for the conditions encountered. Each connection with an existing pipe shall be made at a time and under conditions which will least interfere with service to customers, and as authorized by Owner. Facilities shall be provided for proper dewatering and for disposal of water removed from the dewatered lines and excavations without damage to adjacent property.

3-7. SERVICE CONNECTIONS. Not used.

3-8. CONCRETE ENCASEMENT. Concrete encasement shall be installed as indicated on the drawings. Concrete and reinforcing steel shall be as specified in the Cast-in-Place Concrete section. All pipe to be encased shall be suitably supported and blocked in proper position and shall be anchored against flotation.

3-9. RESTRAINED JOINTS. All bell-and-spigot or all-bell tees, Y-branches, bends deflecting 11-1/4 degrees or more, valves, and plugs which are installed in piping subjected to internal hydrostatic heads in excess of 30 feet shall be provided with suitable restrained joints.

All steel clamps, rods, bolts, and other metal accessories used in tapping saddles or reaction anchorages subject to submergence or in contact with earth or other fill material, and not encased in concrete, shall be coated in accordance with the Protective Coatings section.

3-10. PRESSURE AND LEAKAGE TESTS. After installation, PVC piping shall be hydrostatically tested for defective workmanship and materials as specified in the Pipeline Pressure and Leakage Testing section.

3-11. LEAKAGE. All PVC piping shall be watertight and free from leaks. Each leak which is discovered within the correction period stipulated in the General Conditions shall be repaired by and at the expense of Contractor.

End of Section

Schedule 02630-S01

Polyvinyl Chloride (PVC) Pressure Pipe Schedule

Size in.	Dimension Ratio	Location
4 to 12	18	Below grade force main piping
16 to 24	25	Below grade force main piping

This page was left blank intentionally

CLEANING AND DISINFECTION OF POTABLE WATER LINES

PART 1 - GENERAL

1-1. SCOPE. This section covers cleaning and disinfection of all potable water lines installed under this contract.

1-2. GENERAL.

1-2.01. Coordination. Contractor shall coordinate flushing and disinfection work with adjacent work as necessary to preclude work interferences or duplication of effort and to expedite the overall progress of the work.

Contractor shall provide all necessary piping, piping connections, temporary valves, backflow preventers, flowmeters, sampling taps, pumps, disinfectant, neutralization agents, chlorine residual test apparatus, and all other items of equipment or facilities necessary to complete the disinfection work.

Water for flushing and disinfection work will be provided as stipulated in the Temporary Facilities section..

In all cases where it is necessary to interrupt service, permission of Owner shall be obtained at least two days before the service will be interrupted.

Unless otherwise specified, final cleaning work shall not be performed until after hydrostatic testing of the lines and any resulting repair work completed.

Contractor shall notify Orange County Utilities prior to the work to allow their representatives to be present during cleaning and/or disinfection of the water lines.

1-2.02. Related Work. Other sections directly related to Work covered in this section are:
02704 – Pipeline Pressure and Leakage Testing
15067 - Miscellaneous Plastic Pipe, Tubing, and Accessories

1-2.03. Governing Standard. All disinfection work shall conform to the requirements of ANSI/AWWA C651, and the requirements of Florida Department of Environmental Protection, except as modified herein. If any state or local requirements conflict with the provisions of this section, the state and local requirements shall govern.

1-3. SUBMITTALS.

1-3.01. Disinfection Plan. Prior to starting any disinfection work, Contractor shall submit to Engineer a detailed disinfection plan. The plan shall cover the method and procedure proposed, necessary coordination, qualification of personnel performing the disinfection, sequence of operations, equipment to be used, manner of filling and flushing the lines, chlorine injection points, sample points, testing schedule, potable water source, neutralization, and disposal of

wasted water. Personnel performing the disinfection shall demonstrate a minimum of 5 years experience in the chlorination and dechlorination of similar pipelines.

1-3.02. Testing. Bacteriological testing shall be performed by Owner's staff.

The chlorine residual test shall be performed by Contractor. The test log shall be made available to Owner or Engineer upon request and shall be provided to Engineer upon completion of all chlorine residual testing.

1-4. QUALITY ASSURANCE.

1-4.01. Chlorine Residual Tests. Contractor shall provide the necessary apparatus for making the chlorine residual tests by the drop dilution method as set forth in Appendix A of ANSI/AWWA C651. Test results shall be recorded in a logbook that includes for each test: the location, date, time, test results, and test kit manufacturer.

1-4.02. Bacteriological Tests. Sampling and testing of water in the lines shall be performed after final flushing in accordance with Section 5 of ANSI/AWWA C651, including a standard heterotrophic plate count for each sample.

1-4.03. Redisinfection. Should the bacteriological tests indicate the presence of coliform organisms at any sampling point, the lines shall be reflushed, resampled and retested. If check samples show the presence of coliform organisms, then the lines shall be rechlorinated until acceptable results are obtained.

PART 2 - PRODUCTS

2-1. MATERIALS. All materials furnished by Contractor shall conform to the requirements of ANSI/AWWA C651 and shall be clean and free of debris which could infer questionable test results.

2-1.01. Liquid Chlorine. Liquid chlorine shall conform to AWWA B301.

2-1.02. Calcium Hypochlorite (Dry). Calcium hypochlorite shall conform to AWWA B300.

2-1.03. Sodium Hypochlorite (Solution). Sodium hypochlorite shall conform to AWWA B300.

2-1.04. Chlorine Residual Test Kit. Chlorine, residual concentration shall be measured using an appropriate range, drop count, titration kit or an orthotolidine indicator comparator with wide range color discs. The color disc range shall be selected to match chlorine concentration limits. Test kits shall be maintained in good working order and available for immediate test of residuals at point of sampling. Test kits manufactured by Hach Chemical or Hellige are acceptable.

PART 3 - EXECUTION

3-1. APPLICATION.

3-1.01. Disinfection Procedure. The new lines shall be disinfected by the tablet method, continuous feed method, or slug method. Potable water shall be used in conjunction with the chlorination agent.

For the continuous feed or slug method, the chlorination agent shall be injected into the line at the supply end of each new line or valved section thereof.

Admission of disinfectant solution into or the flushing thereof through existing mains shall be held to the minimum possible, and then only after adequate measures have been taken to prevent any such solution of wastewater from entering branch service connections to water customers.

During disinfection, all valves and hydrants shall be operated to ensure that all appurtenances are disinfected. Valves shall be operated such that the chlorine solution in the line being chlorinated will not flow back into the supply line. Check valves shall be used if needed.

Existing mains which may become contaminated during work requiring connections to the new water line, involving either tapping or cutting into operations, shall be flushed and disinfected in accordance with Section 4 of ANSI/AWWA C651.

3-1.02. Final Flushing. Upon completion of chlorination, but before sampling and bacteriological testing, all heavily chlorinated water shall be removed from the lines by flushing with potable water until the chlorine residual in the lines is not higher than that generally prevailing in the adjacent existing system.

Small pipelines shall be flushed with water at the maximum velocity which can be developed, but not less than 2.5 feet per second [0.76 m/s], unless otherwise permitted by Engineer. Flushing shall be accomplished through the installed valves or fittings, or through corporation cocks in accordance with the details indicated on the drawings.

Pipelines may be flushed as specified, cleaned with a hose, or by other methods acceptable to Engineer.

Booster pumps shall be used if needed to obtain the necessary volume or velocity of water. Pumping equipment installed under this contract shall not be used for flushing, nor shall the flushing water be passed through them; temporary bypass piping at each pump shall be provided as needed.

3-1.03. Cleaning. The potable water mains installed under this contract, including all associated valves and fittings, shall be flushed or cleaned to the satisfaction of Owner and Engineer.

All new piping shall be cleaned by flushing with water at the maximum velocity which can be developed until the piping is free of dirt, debris, and other foreign materials. Cleaning shall precede disinfection. Flushing shall be accomplished through the installed valves or fittings, or through corporation cocks furnished and installed for that purpose.

3-1.04. Disposal of Chlorinated Wastewater. All chlorinated wastewater to be discharged shall be neutralized by chemical treatment and disposed in accordance with the requirements of the governing agency specified herein. Schedule and coordinate rates of flow and locations of

discharge of disinfection and flushing water with Engineer and cognizant state and local regulatory agencies to ensure compliance with all applicable rules and regulations.

End of Section

SEWER PIPE INSTALLATION AND TESTING

PART 1 - GENERAL

1-1. SCOPE. This section covers the installation and testing of all sewer pipe furnished under the following specification sections:

<u>Section</u>	<u>Description</u>
02628	PVC Sewer Pipe

Pipe trenching, bedding, and backfill are covered in the Trenching and Backfilling section.

1-2. DELIVERY, STORAGE, AND HANDLING. Shipping shall be in accordance with the Shipping section. Handling and storage shall be in accordance with the Handling and Storage section.

Pipe, fittings, and appurtenances shall be transported, stored, and handled in a manner which prevents damage. Hooks shall not be permitted to come into contact with joint surfaces. Plastic pipe shall be shaded if necessary to prevent curvature due to thermal expansion. Damaged pipe and fittings shall be removed from the site.

PART 2 - PRODUCTS

2-1. MATERIALS. Sewer pipe materials are specified in the pipe sections.

PART 3 - EXECUTION

3-1. ALIGNMENT. Piping shall be laid to the lines and grades indicated on the drawings. Batter boards, laser beam equipment, or surveying instruments shall be used to maintain alignment and grade. At least one elevation measurement shall be made on each length of pipe.

If batter boards are used to determine and check pipe subgrades, they shall be erected at intervals of not more than 25 feet. At least three batter boards shall always be maintained in proper position when trench grading is in progress.

If laser beam equipment is used, periodic elevation measurements shall be made with surveying instruments to verify accuracy of grades. If such measurements indicate thermal deflection of the laser beam due to differences between the ground temperature and the air temperature within the pipe, precautions shall be taken to prevent or minimize further thermal deflections.

3-2. LAYING PIPE. Pipe shall be protected from lateral displacement by embedment material installed as specified in the Earthwork section. Pipe shall not be laid in water or under unsuitable weather or trench conditions.

Pipe laying shall begin at the lowest elevation with bell ends facing the direction of laying, except when reverse laying is permitted by Engineer.

Foreign material shall be kept out of the pipe during installation. No debris, tools, clothing, or other foreign objects shall be placed in the pipe.

Whenever pipe laying is stopped, the open end of the pipe shall be closed with a tight-fitting end board to keep out soil. The end board shall have perforations near the center to admit water and prevent flotation of the pipe in the event the trench becomes flooded.

3-3. JOINTING. All joint preparation and jointing procedures shall comply with the instructions and recommendations of the manufacturer.

3-3.01. Rubber Gasketed Joints. Rubber gaskets shall be positioned on the joint in accordance with the manufacturer's recommendations. Immediately before joints are pushed together, all joint surfaces shall be thoroughly cleaned and coated with the lubricant furnished with the pipe. The gasket shall be lubricated and positioned in the spigot groove so that the gasket is distributed uniformly around the pipe circumference. The position of the rubber gasket shall be checked with a feeler gauge after each joint is completed. If the gasket is not in the proper position, the joint shall be pulled apart, the gasket removed and discarded, and the joint re-assembled using a new, properly lubricated gasket.

Joint lubricant shall be stored in closed containers and shall be kept clean. When installing pipe in cold weather, the joint surfaces and gaskets shall be kept warm and the joint lubricant shall be prevented from freezing.

For rubber and steel joints, each exterior joint recess shall be filled with joint grout. A diaper shall be used to prevent foreign material from entering the joint recess before grouting and to serve as a form for the grout. Each diaper shall be of sufficient length to encircle the pipe, leaving enough space between the ends to allow the grout to be poured. Joint grout shall be poured between the diaper and the pipe and shall be allowed to run down to the bottom of the pipe. The grout shall be rodded while being poured, using a stiff wire curved to the approximate shape of the pipe. Each joint recess shall be completely filled with grout for the full circumference of the pipe.

Not less than two lengths of pipe shall be in final position in advance of exterior joint grouting. If placing of pipe embedment is resumed before the grout has attained initial set, care shall be taken to prevent damage to the grout while placing and compacting embedment material.

After trench backfilling has been completed, the inside joint recess of all pipe with rubber and steel joints shall be filled with mortar. Joint surfaces shall be damp, but free from surface water, when the mortar is placed. Mortar shall be thoroughly compacted to completely fill the recess and shall be finished smooth. All excess mortar shall be removed from the pipe.

3-3.02. Flexible Sealant Joints. Joints made with flexible joint sealant shall be coated with the recommended adhesive, and the joint sealant shall be positioned in accordance with the manufacturer's installation instructions. The pipe sections forming the joint shall be pulled

together with sufficient force to uniformly fill and seal the annular space in the joint. Joints shall not be made when adverse weather conditions may prevent proper sealing, nor when the temperature of the pipe and sealing materials is too low to achieve proper sealing.

3-3.03. Mastic Joints. Surfaces of pipe to be joined with mastic joints shall be primed, if recommended by the mastic manufacturer. Immediately before joining the pipes, a uniform layer of mastic shall be applied to the joint surfaces. After the pipes are in final position, the mastic shall completely fill and seal the annular space in the joint. Joints shall not be made when weather conditions may interfere with obtaining a satisfactory seal.

3-4. CONCRETE ENCASUREMENT. Concrete encasement shall be installed where indicated on the drawings. A pipe joint shall be provided within 12 inches of each end of the concrete encasement. Concrete and reinforcing steel shall be as specified in the Cast-in-Place Concrete section. All pipe which is to be encased shall be suitably supported and blocked in proper position and shall be anchored against flotation.

3-5. ACCEPTANCE TESTS. Each reach of sewer shall meet the requirements of the following acceptance tests. All defects shall be repaired to the satisfaction of Engineer.

3-5.01. Lamping. Unless otherwise indicated on the drawings, each section of sewer line between manholes shall be straight and uniformly graded. Each section will be lamped by Engineer. Contractor shall furnish suitable assistants to assist Engineer.

3-5.02. Exfiltration. An exfiltration test shall be conducted on each reach of sewer between manholes. The first line between manholes shall be tested before backfilling and before any additional sewer pipe is installed. Thereafter, exfiltration testing shall be done after backfilling, and individual or multiple reaches may be tested at the option of Contractor.

Exfiltration tests shall be conducted by blocking off all manhole openings except those connecting with the reach being tested, filling the line, and measuring the water required to maintain a constant level in the manholes. Each manhole shall be subjected to at least one exfiltration test.

During the exfiltration test, the water depth above the pipe invert at the lower end shall be at least to the elevation of the ground surface, unless otherwise specified. The maximum depth of the water at the lower end shall not exceed 25 feet, and the minimum depth of the water at the upper end shall be at least 5 feet above the crown of the pipe or 5 feet above groundwater elevation, whichever is higher.

The total exfiltration shall not exceed 25 gallons per inch of nominal diameter per mile [9 liters per millimeter of nominal diameter per kilometer] of pipe per day for each reach tested. For purposes of determining maximum allowable leakage, nominal diameter and depth of manholes shall be included. The exfiltration tests shall be maintained on each reach for at least 2 hours and shall be longer if necessary, in the opinion of Engineer, to locate all leaks.

Contractor shall provide, at his own expense, all necessary piping between the reach to be tested and the source of water supply, and all labor, equipment, and materials required for the tests. The methods used and the time of conducting exfiltration tests shall be acceptable to Engineer.

3-5.03. Low Pressure Air Testing. Low pressure air testing may be used in lieu of exfiltration testing for 24 inch diameter and smaller pipe. Air testing shall not be used for manholes, or for pipe larger than 24 inches in diameter.

Low pressure air testing shall comply with Uni-Bell PVC Pipe Association “Recommended Practice for Low Pressure Air Testing of Installed Sewer Pipe”. The schedule of testing shall be submitted to Engineer prior to starting the tests. The time of conducting the tests shall be acceptable to Engineer.

The time elapsed for a 1 psi drop in air pressure shall be not less than, nor shall the air loss exceed, the limits set forth in the governing standard.

If the length of sewer to be tested is fully or partially submerged in groundwater, the test pressure shall be increased if necessary to overcome the actual static pressure exerted by the groundwater. If a test pressure greater than 8 psi results, air testing shall not be used, and exfiltration testing will be required.

Leaks shall be located by testing short sections of pipe. Leaks shall be repaired and the reach of sewer retested.

3-5.04. Infiltration. If, at any time prior to expiration of the correction period stipulated in the General Conditions, infiltration exceeds 100 gallons per inch of nominal diameter per mile [9 L/mm of nominal diameter/km] of sewer per day, Contractor shall locate the leaks and make repairs as necessary to control the infiltration.

3-5.05. Deflection. After backfilling is completed, and before acceptance of the work, each reach of PVC and composite sewer pipe shall be checked for excessive deflection by pulling a mandrel through the pipe, or by other methods acceptable to Engineer. Pipe with diametrical deflection exceeding 5 percent of the inside diameter shall be uncovered, and the bedding and backfill replaced to prevent excessive deflection. Repaired pipe shall be retested.

3-6. CLEANING. The interior of all pipe and fittings shall be thoroughly cleaned before installation and shall be kept clean until the work has been accepted. All joint contact surfaces shall be kept clean until the joint is completed.

End of Section

PIPELINE PRESSURE AND LEAKAGE TESTING

PART 1 - GENERAL

1-1. SCOPE. This section covers field hydrostatic pressure and leakage testing of piping. The term "piping" shall be used in this section to refer to piping systems, pipelines, or sections thereof.

Testing of other piping is covered in the Sewer Pipe Installation and Testing section and Miscellaneous Piping and Accessories Installation section. Cleaning and disinfection of piping is covered in another section if required.

1-2. GENERAL. Unless otherwise specified, testing of piping shall be completed prior to final cleaning and disinfection.

Contractor shall notify federal, state, and local regulatory agencies to determine if any special procedures or permits are required for disposal of water used for pressure and leakage testing and to identify acceptable locations for disposal of the water. All requirements and costs associated with notifications and obtaining any discharge permit or approvals shall be responsibility of Contractor.

Engineer or Engineer's representative shall be present during testing and shall be notified of the time and place of testing at least 3 days prior to commencement of the work. All work shall be performed to the satisfaction of Engineer.

1-2.01. Testing Schedule and Procedure. A testing schedule and test procedure shall be submitted to Engineer for review and acceptance not less than 21 days prior to commencement of testing. The schedule shall indicate the proposed time and sequence of testing of the piping. The testing procedure shall establish the limits of the piping to be tested, the positions of all valves during testing, the locations of temporary bulkheads, and all procedures to be followed in performing the testing.

1-2.02. Special Testing Requirements. Special testing requirements include the following:
The basic provisions of AWWA C600 shall be applicable.

1-2.03. Water. Water for testing shall be furnished as stipulated in the Temporary Facilities section. As a conservation measure, the water shall be collected for reuse in subsequent testing. Following completion of testing, the water shall be disposed of in a manner acceptable to Engineer. Unless otherwise permitted, the water shall be kept out of the remainder of the piping.

PART 2 - PRODUCTS

2-1. TEST EQUIPMENT. All necessary connections between the piping to be tested and the water source, together with pumping equipment, water meter, pressure gauges, and all other

equipment, materials, and facilities required to perform the specified tests, shall be provided. All required flanges, valves, bulkheads, bracing, blocking, and other sectionalizing devices shall also be provided. All temporary sectionalizing devices shall be removed upon completion of testing. Vents shall be provided in test bulkheads where necessary to expel air from the piping to be tested.

Test pressures shall be applied by means of a force pump sized to produce and maintain the required pressure without interruption during the test.

Water meters and pressure gauges shall be accurately calibrated and shall be subject to review and acceptance by Engineer.

Permanent gauge connections shall be installed at each location where test gauges are connected to the piping during the required tests. Drilling and tapping of pipe walls will not be permitted. Upon completion of testing, each gauge connection shall be fitted with a removable plug or cap acceptable to Engineer.

PART 3 - EXECUTION

3-1. FILLING AND VENTING. Before filling the piping with water, care shall be taken to ensure that all air release valves and other venting devices are properly installed and in the open position. Hand-operated vent valves shall not be closed until an uninterrupted stream of water is flowing from each valve. The rate of filling the piping with water must not exceed the venting capacity of the installed air vent valves and devices.

3-2. BLOCKING AND BACKFILLING. Piping shall be adequately blocked, anchored, and supported before the test pressure is applied.

3-3. PRESSURE TESTING. After the piping to be tested has been filled with water, the test pressure shall be applied and maintained without interruption within plus or minus 5 psi of test pressure for 2 hours plus any additional time required for Engineer to examine all piping being tested and for Contractor to locate any defective joints and pipe materials. The test pressure shall be in accordance with the requirements specified for pipeline or plant piping.

3-3.01. Pipeline Test Pressure. Piping shall be subjected to a hydrostatic test pressure of 100 psi.

The test pressure, expressed in feet of water, to be applied at any point in the piping shall be equivalent to the arithmetic difference between the specified test pressure plane elevation and the elevation of the horizontal center line of the piping at the selected location. The value obtained shall be multiplied by 0.433 to obtain psi.

3-3.02. Plant Piping Test Pressure. Not used.

3-4. PLANT PIPING LEAKAGE. Not used.

3-5. PIPELINE LEAKAGE TESTING. Following completion of pressure testing and acceptance by Engineer, the pipeline piping shall be subjected to a leakage test. The duration of the leakage test shall be 2 hours plus the additional time required for Engineer to make an accurate determination of leakage. If during test, the integrity of the tested line is in question, the Owner may require a 6-hour pressure test.

3-5.01. Leakage Test Pressure. The hydrostatic pressure maintained during the leakage test shall be at least 75 percent, but not more than 100 percent, of the pressure specified for pressure testing of the piping and shall be maintained within plus or minus 5 psi [35 kPa] during the entire time that leakage measurements are being performed.

3-5.02. Leakage Measurement. Measurement of leakage shall not be attempted until all trapped air has been vented and a constant test pressure has been established. After the pressure has stabilized, piping leakage shall be measured with a suitable water meter installed in the pressure piping on the discharge side of the force pump.

3-5.03. Allowable Leakage. The term "leakage", as used herein, refers to the total amount of water which must be introduced into the piping during the leakage test to maintain the test pressure.

No piping will be accepted if and while it exhibits a leakage rate in excess of that determined by the indicated formulas:

$$Q = \frac{DLN}{148,000} \text{ (using inch-pound units)}$$

Where

Q = allowable leakage in gallons per hour

D = nominal diameter of pipe in inches

L = length of section tested in feet

N = square root of average test pressure in pounds per square inch

Whenever the piping to be tested contains pipe of different diameters, the allowable leakage shall be calculated separately for each diameter and the corresponding length of piping. The resulting allowable leakage rates shall be added to obtain the total allowable leakage for the entire piping.

All joints in piping shall be watertight and free from visible leaks during the leakage test. Each leak which is discovered within the correction period stipulated in the General Conditions shall be repaired by and at the expense of Contractor regardless of the amount that the total leakage may have been below the specified allowable leakage rate during the leakage test.

If the leakage test indicates a higher than allowable leakage rate, Contractor shall locate and repair leaking joints and other defective work to the extent necessary to reduce the leakage to an acceptable value.

End of Section

This page was left blank intentionally

SODDING

PART 1 - GENERAL

1-1. DESCRIPTION

- A. Provide all materials, water, equipment, transportation, tools, and labor, to establish grass plus all items called for or that can be reasonably inferred from the drawings, including sodding, grading, fertilizing, watering, mowing, replacing and maintaining the area for a complete job.
- B. Sod all disturbed areas.

1-2. APPLICABLE PUBLICATIONS

Portions of the publications listed below form a part of this specification only to the extent referenced.

- A. Florida Department of Transportation, "Standard Specifications for Road and Bridge Construction" (Fla. DOT SPEC).
- B. Turfgrass Producers Association of Florida, "Standards of Sod Quality".

1-3. RECORDS

Submit written weekly records to the Owner of all grassed areas for use in determining the beginning and ending of the maintenance period for each area. The records shall indicate the date of grassing, fertilizing and mowing, the type of sod, quantity (sq. ft., sq. yds, or acres) and location of grassing.

1-4. SUBMITTALS

- A. Submit Shop Drawings in accordance with the General Conditions. Submit certificates stating that the materials conform to the requirements of this specification as follows:
 - 1. Certificate from sod producer stating that sod meets the requirements for "Florida Standard Grade" as defined by the Turfgrass Producers Association of Florida, and set forth in paragraph "SOD" of this specification.
 - 2. Fertilizer manufacturer's certificate of analysis including Nitrogen, Phosphorus Potash and complete micro-nutrients in accordance with paragraph "Fertilizer" of this specification.
- B. Submit a copy of the certificate(s) with each delivery.

PART 2 - PRODUCTS

2-1 SOD

- A. Argentine Bahia with well matted roots. The sod shall be taken up in commercial-size rectangles, preferably 12-inch by 24-inch or larger, except where 6-inch strip sodding is called for.
- B. The sod shall have no visible broadleaf weeds when viewed from a standing position and the turf shall be visibly consistent with no obvious patches of foreign grasses. In no case may the total amount of foreign grasses or weeds exceed 2% of the total canopy. Florida Standard Grade sod shall be neatly mowed and mature enough that when grasped at one end it can be picked up and handled without damage. The sod shall be sufficiently thick to secure a dense stand of live grass. The sod shall be live, fresh and uninjured, at the time of planting. It shall have a soil mat of sufficient thickness adhering firmly to the roots to withstand all necessary handling.

2-2 FERTILIZER

Commercial grade, controlled release, granular fertilizer consisting of blend of coated prilled urea with iron included in a slowly soluble form, free flowing and uniform in composition conforming to Florida DOT Specification 982-1, and bearing the manufacturer's guaranteed statement of analysis by weight of 12 parts nitrogen, 8 parts phosphoric acid and 8 parts potash, plus complete micronutrient including magnesium, sulfur, zinc, manganese, copper and boron.

2-3 SOURCE REQUIREMENTS FOR SOD

Comply with all current restrictions for transporting sod material from or through quarantine areas for the white fringed beetle, witchweed, and West Indian sugar cane borer weevil, as issued by the Division of Plant Industry, Florida Department of Agriculture and the Animal and Plant Health Inspection Service, U.S. Department of Agriculture.

2-4 WATER FOR GRASSING

Water shall be free of acid, alkali, or organic materials and shall have a pH of 7.0 to 8.5. Provide all water needed for grassing. Provide permanent or temporary piping and valves, and temporary trucks to convey water from the source to the point of use. Provide any meters required and pay for water used if the water is taken from a public water system. Water shall be free of petroleum products, pesticides and any other deleterious constituents.

PART 3 - EXECUTION

3-1 COORDINATION OF WORK

Coordinate all work activities to provide for establishment of grass cover at the earliest possible time in the construction schedule to minimize erosion of topsoil.

3-2 CONSTRUCTION METHODS - GENERAL

- A. Provide sod and establish grass in all areas designated on the drawings and that are disturbed during construction (except areas to be paved, landscaped or covered with structures).

- B. Do not fertilize when wind velocities exceed 15 miles per hour. Sod only when the soil is in proper condition to induce growth.
- C. When a length of roadway slopes or adjacent areas have been graded and made ready, commence grassing in accordance with these specifications. Incorporate grass covering into the project at the earliest practical time in the life of the contract to reduce potential erosion.
- D. Store fertilizer in dry locations away from contaminants. Sprinkle sod with water and protect from exposure to wind and direct sunlight until planted. Provide covering that will allow air to circulate so that heating will not develop.

3-3 CONSTRUCTION METHODS FOR GRASSING

- A. Sequence of Operations: The operations involved in the work shall proceed in the following sequence:
 - 1. Preparation of the ground.
 - 2. Sodding.
 - 3. Watering and maintaining

3-4 PREPARATION OF AREA TO BE GRASSED

- A. Prepare the areas to be grassed by disc-harrowing and thoroughly pulverizing them to a depth of at least 6 inches.
- B. Bring all areas to be grassed to finished grades, remove weeds, surplus dirt and rock debris over 1 inch in diameter, and rough grade the area.
- C. Test the soil for pH. If the soil is below a pH level of 5.5, spread lime to raise the pH level to at least 5.5.
- D. Uniformly apply fertilizer at the rate of 400 to 500 pounds per acre. Immediately after the fertilizer and/or lime is spread over the area, mix them into the soil to a depth of approximately 4 inches.
- E. Float the area to a smooth uniform grade. Slope all areas to drain. Establish flow lines as shown on the drawings. Finish areas to be grassed approximately 1 inch below top of adjoining curb or pathway.

3-5. SODDING

- A. Incorporate sodding into the project at the earliest practical time in the life of the contract. Do not use sod which has been cut for more than 3 days. Stack any sod which is not planted within 24 hours after cutting and maintain properly moistened.
- B. Place the sod on a prepared surface, with abutting joints. Fill any gaps or cracks between sod blocks with sod. Roll with a minimum one-ton roller to obtain an even surface. Bring the sod edge in a neat, clean manner to the edge of all paving and shrub areas and project limits.
- C. Where sodding is used in drainage ditches, stagger the setting of the pieces to avoid a continuous seam along the line of flow.

- D. On areas where the sod may slide due to height and slope, peg the sod with pegs driven through the sod blocks into firm earth at suitable intervals. Replace any pieces of sod which, after placing, show an appearance of extreme dryness.

3-6 MOWING

- A. Mow first when the grass reaches a height of 3 to 4 inches. Mow a second time when the grass reaches a height of 6 inches and before a seedhead occurs. Subsequent mowings should establish a uniform grass surface of 2-1/2 inches and be made before seedhead occurs. All mowings should be made with a cut height as low as possible to stop shading of the Bahia grass.
- B. Mow sod to establish a uniform grass surface of 2-1/2 inches.
- C. Provide equipment for mowing that does not rut the soil surface. Fill any ruts that are in excess of two (2) inches deep with native soil free from twigs and rocks larger than 1 inch in diameter. Temporarily suspend mowing operations when the soil is too wet to provide adequate support and traction for equipment.

3-7 WATERING

- A. Maintain a balanced watering program until the acceptance of work.
- B. Apply water in sufficient quantities and as often as seasonal conditions require to keep the grassed areas moist.
- C. Provide supplemental water and irrigate areas when the rainfall is not adequate to maintain soil moisture necessary for germination and growth of the grass. It is Contractor's responsibility to determine the quantities of water required and when to irrigate. This obligation shall remain in full force and effect until final acceptance of the work by Owner and shall be provided at no additional cost to Owner.
- D. Owner, at his discretion, may relieve Contractor of this obligation at such time as Owner is able to provide irrigation. This action, however, does not relieve Contractor of the provisions and guarantees set forth in the Contract Documents.

3-8 MAINTENANCE

- A. Maintain all grassed areas for a period of 90 days after the date of substantial completion and guarantee against all defects and faults of material and workmanship.
- B. Maintain grass areas by watering, fertilizing, and mowing to establish an even and uniform grass surface of 2-1/2 inches, as specified above.
- C. In the event that the grass exhibits iron chlorosis symptoms during the establishment period, apply liquid iron at manufacturer's recommended rates.

3-9 GUARANTEE

- A. Guarantee all grasses areas to be alive and in satisfactory growth at the end of the maintenance period (90 days).
- B. Replace any grass that is dead or not in satisfactory growth, as determined by the Owner or Owner's representative. Guarantee new sod for an additional 90 days.

- C. The term "Satisfactory Growth" as used in this section is defined as even plant growth in healthy conditions without bare spots. Bare spots in sodded areas shall be resodded. All sodded areas shall be maintained until satisfactory growth has been demonstrated. In the event that the subsequent stand of grass is found to be contaminated with weeds or other obnoxious or undesirable growth, effectively eliminate such undesirable growth, at the Contractor's expense.
- D. Replace sod with the same variety as initially specified.

3-10 INSPECTION

- A. Request inspection from the Owner and his representative at least 72 hours in advance of the time inspection is required.
- B. Provide an authorized representative to be on-site during inspection.

END OF SECTION

This page was left blank intentionally

ORNAMENTAL SWING GATES

PART 1 – GENERAL

1-1. **SCOPE.** Furnish all labor, materials, equipment and incidentals necessary and install the ornamental aluminum swing gates for manual operation as shown on the Drawings and as specified herein. Ornamental swing gates shall be provided at the pump stations surrounded by a block wall.

1-2. **SUBMITTALS.**

- A. Submit to the Engineer, in accordance with Section 01300, shop drawings showing details and specifications on materials, layouts and details of construction and erection of fence, gates, operator and accessories required.
- B. Provide samples of specified finishes on proposed aluminum, stainless steel and steel sections, hardware and sheet showing materials, finish and color for approval.

PART 2 – PRODUCTS

2-1. **MATERIALS.**

- A. Aluminum Extrusions - All components shall be 6063-T5 and 6105-T5 alloy extrusions as approved, conforming to ASTM B221.
- B. Fasteners — All screws shall be Type 410 stainless steel, self-drilling. Provide masonry anchors and stainless steel machine screws for masonry connections as approved. All screws shall be painted to match the finish of aluminum.
- C. Accessories — Provide aluminum wall brackets and required stainless steel hardware.
- D. Bracing Cables — Stainless steel, Type 304 wire rope with stainless steel hardware. Size to provide required bracing for gate rigidity in cross-brace configuration and minimum visual impact.
- E. Finish— The gate and components shall be factory coated with Specrail Poly-Color or equal high- solids acrylic coating meeting AAMA 603.8. Application shall be by electrostatic spray. Curing shall be at a temperature of 375EF to 400EF. Color shall be black.
- F. Operator housing and base — Factory powder coated as approved. Color-black.

2-2. FABRICATION.

- A. Horizontal rails, 1-5/8-in square, open extrusions, shall be punched to allow pickets to pass through the top of the rail and into bottom rail.
- B. Pickets, 1-in square, 0.065-in wall, tubes, integral spear point finial, shall be fastened to stringers mechanically with stainless steel TEK screws on one side of stringer only.
- C. Vertical members, 2-1/2-in square, 0.075-in wall, tubes shall be prepunched to allow horizontal rails to swing in and be attached with stainless steel TEK. Gate posts, 4-in square, 0.125-in wall, tubes. Cast aluminum post caps shall be affixed to all posts and verticals.
- D. Provide in configurations shown and approved for rigidity and appearance. Cross brace on inside with stainless steel cable, each panel shown making up the gate.

2-3. HARDWARE.

- A. Gate Hangers, latches, brackets, guide assemblies and stops shall be aluminum, or steel galvanized after fabrication.
- B. Positive latch device shall be provided with provisions for padlocking.

PART 3 – EXECUTION

3-1. PREPARATION. Prepare the grade and remove surface irregularities, if any, which may cause interference with the installation of gate and components.

3-2. INSTALLATION.

- A. Set gate posts for gate opening as shown, providing support for gate in open and closed positions.
- B. Insert rail ends into pre-punched posts and fasten with TEK screws.
- C. Center and align posts. Place concrete around posts and vibrate for consolidation. Recheck vertical and top alignment of posts, and make necessary corrections. Depth of post and full-depth concrete encasement shall be as required and approved to provide rigidity under all operating and wind conditions.
- D. Install gate plumb, level and secure for full opening without interference. Use masonry anchor system specified below where required. Install operator on a concrete pad, program as required and test to the satisfaction of the Engineer. Clean cement paste from components before it dries.

- E. Install fence sections between concrete block columns. Drill the precast for expansion anchors and set to receive fence and gate post support hardware. Install fence sections and required gate support appurtenances plumb, level and secure as approved.

3-3. CLEANING, REPAIR AND REPLACEMENT.

- A. Contractor shall clean jobsite of excess materials and excavated matter. Clean aluminum with mild household detergent and clean water rinse thoroughly.
- B. Adjust operator and all hardware for smooth operation of gate and test as ordered. Repair or replace operator components as required and retest as ordered.
- C. The Engineer will inspect all fence/gate components and finishes. Repair or replace components and finishes as order. Cement paste not removed before it dried shall be carefully removed and finish repaired or component replaced as ordered.

End of Section

This page was left blank intentionally

Section 03301

CONCRETE

PART 1 - GENERAL

1-1. SCOPE. This section covers all cast-in-place concrete, including reinforcing steel, forms, finishing, curing, and appurtenant work. All concrete shall be air-entrained.

Both inch-pound (English) and SI (metric) units of measurement are specified herein; the values expressed in inch-pound units shall govern.

1-2. GENERAL. All cast-in-place concrete shall be accurately formed and properly placed and finished as indicated on the drawings and as specified herein.

1-3. SUBMITTALS. All submittals of drawings and data shall be in accordance with the submittals section.

1-4. STORAGE AND HANDLING. Cement shall be stored in suitable moistureproof enclosures. Cement which has become caked or lumpy shall not be used.

Aggregates shall be stored so that segregation and the inclusion of foreign materials are prevented. The bottom 6 inches [150 mm] of aggregate piles in contact with the ground shall not be used.

Reinforcing steel shall be carefully handled and shall be stored on supports that will prevent the steel from touching the ground.

PART 2 - PRODUCTS

2-1. LIMITING REQUIREMENTS. Unless otherwise specified, concrete shall be controlled within the following limiting requirements.

2-1.01. Cement Content. The quantity of Portland cement in the concrete shall be not less than that indicated in the following table:

Quantity of Cement (lb/yd ³) [kg/m ³]			
Coarse Aggregate Size from No. 4 [4.75 mm] Sieve to			
3/8 in. [9.5 mm]	1/2 in. [12 mm]	3/4 in. [19 mm]	1 in. [25 mm]

Quantity of Cement (lb/yd ³) [kg/m ³]			
Coarse Aggregate Size from No. 4 [4.75 mm] Sieve to			
600 [355]	580 [344]	560 [333]	535 [318]

2-1.02. Maximum Water-Cementitious Ratio. The maximum water-cementitious ratio shall be 0.42 on a weight basis. If fly ash is used, the combined mass of cement plus fly ash shall be used to determine the water-cementitious materials ratio.

2-1.03. Fly Ash Content. At the option of the Contractor, fly ash may be substituted for up to 25 percent of the portland cement, but not less than 15 percent, on the basis of 1.0 lbs [1.0 kg] of fly ash added for each lb [kilogram] of cement reduction.

2-1.04. Coarse Aggregate. The maximum nominal coarse aggregate size shall be not larger than 1 inch [25 mm].

2-1.05. Slump. Concrete slump shall be kept as low as possible consistent with proper handling and thorough compaction. Unless otherwise authorized by the Engineer, slump of concrete without a superplasticizer shall not exceed 4 inches [100 mm]. Slump of concrete with a superplasticizer, or a midrange water reducer, shall not exceed 8 inches.

2-1.06. Total Air Content. The total volumetric air content of concrete after placement shall be 6 percent \pm 1 percent.

2-1.07. Admixtures. The admixture content, batching method, and time of introduction to the mix shall be in accordance with the manufacturer's recommendations. A water-reducing admixture and an air-entraining admixture shall be included in all concrete. A midrange water reducer or a superplasticizer may be used at the Contractor's option. No calcium chloride or admixture containing chloride from sources other than impurities in admixture ingredients will be acceptable.

2-1.08. Strength. The minimum acceptable compressive strengths, as determined by ASTM C39 with 6 inch [150 mm] diameter by 12 inch [300 mm] cylinders, shall be:

Age	Minimum Compressive Strength
7 days	3,375 psi [23.5 MPa]
28 days	4,500 psi [31.5 MPa]

2-2. MATERIALS.

Cement	ASTM C150, Type II or I/II, low alkali.
Fly Ash	ASTM C618, Class F, except loss on ignition shall not exceed 4 percent.
Fine Aggregate	Clean natural sand, ASTM C33. Artificial or manufactured sand will not be acceptable.
Coarse Aggregate	Non-reactive crushed rock, washed gravel, or other inert granular material conforming to ASTM C33, class 4S, except that clay and shale particles shall not exceed 1 percent.
Water	Potable.
Admixtures	
Water-Reducing	ASTM C494, Type A or D.
Air-Entraining	ASTM C260.
Superplasticizing	ASTM C494, Type F or G.
Reinforcing Steel	
Bars	ASTM A615, Grade 60, deformed.
Welded Wire Fabric	ASTM A185 or A497.
Bar Supports	CRSI Class 1, plastic protected; or Class 2, stainless steel protected.
Mechanical Connector (Couplers or Form Savers)	Classified Type 2 per ACI 318-02 or per UBC-97. Use only where indicated on the drawings.
Water stops	
Metal, at construction joints	Uncoated carbon steel, 12 gage, size as indicated on the drawings.
PVC, at construction joints	Extruded, virgin, elastomeric, polyvinyl chloride (PVC), white (no pigment), flat, ribbed, 3/8 inch [9.5 mm] thick. Reclaimed material will not be acceptable. Provide hog rings or grommets spaced at 12 inches [300 mm] on center entire length.

For concrete sections less than 12 inches [300 mm] in thickness	6 inches [150 mm] wide, 3/8 inch [9.5 mm] thick; Greenstreak "679" or Vinylex "R6-38"
For concrete sections 12 inches [300 mm] or more in thickness	9 inches [225 mm] wide, 3/8 inch [9.5 mm] thick; Greenstreak "646" or Vinylex "R9-38"
Forms	
Plywood Product	Standard PS1, waterproof, resin-bonded, exterior type, Douglas fir.
Lumber	Straight, uniform width and thickness, and free from knots, offsets, holes, dents, and other surface defects.
Form Coating	Nonstaining and nontoxic after 30 days, VOC-compliant; Burke "Form Release (WB)", L&M Chemical "E Z Strip", Nox-Crete "Form Coating", or Symons "Thrift Kote E".
Pre-Cure Finishing Aid	Burke "Finishing Aid Concentrate", Euclid "Euchar", L&M Chemical "E-Con", Master Builders "Confilm", or Sika "Sikafilm".
Polyethylene Film	Product Standard PS17 or ASTM D 4397, 6 mils [150 µm] or thicker.
Vapor barrier and seam tape	Polyolefin geomembrane, Stego Wrap, 15 mils [0.38 mm] Vapor Barrier. Stego Wrap Red polyethelene tape.
Membrane Curing Compound and Floor Sealer	
VOC – Compliant	ASTM C1315, Type I, Class A, water based, VOC-compliant acrylic, maximum VOC 2.9 lb/gal [350 g/L], minimum 30 percent solids, nonyellowing, unit moisture loss 0.40 kg/m ² in 72 hours maximum.
Waterproofing Admixture	See the Exterior Coating paragraph in Part 3 of this Section

2-3. SUBMITTALS. The source and quality of concrete materials and the concrete proportions proposed for the work shall be submitted to the Engineer for review before concrete is placed.

2-3.01. Laboratory Shrinkage Limits Test. Based on the modified ASTM C157 test procedures as specified herein, the shrinkage limits of concrete shall be the average drying shrinkage of each set of three test specimens cast in the laboratory from a trial batch as measured at the 21 days drying age, and shall not exceed the 0.036 percent, based on a 4 x4 x 11 inch specimen.

A drying shrinkage test shall be conducted on the preliminary trial batch, including admixtures, that are proposed for the project. Three test specimens shall be prepared for each test. Drying shrinkage specimens shall be 4 inch by 4 inch by 11 inch [100 by 100 by 275 mm] prisms with an effective gauge length of 10 inches [250 mm], fabricated, cured, dried, and measured in accordance with ASTM C157 except with the following modifications:

Specimens shall be removed from the molds at an age of 23 hours \pm 1 hour after trial batching, shall be placed immediately in water at 73°F \pm 3°F [23°C \pm 2°C] for at least 30 minutes, and shall be measured within 30 minutes thereafter to determine original length and then submerged in lime-saturated water as specified in ASTM C157. Measurement to determine expansion expressed as a percentage of original length shall be taken at age 7 days. The length at 7 days shall be the base length for drying shrinkage calculations ("0" days drying age). Specimens then shall be stored immediately in a humidity controlled room maintained at 73°F \pm 3°F [23°C \pm 2°C] and 50 percent \pm 4 percent relative humidity for the remainder of the test. Measurements to determine shrinkage expressed as a percentage of the base length shall be reported separately for 7, 14, and 21 days \pm 4 hours of drying from "0" days after 7 days of moist curing for a total of 28 days from the date of casting.

Drying shrinkage deformation for each specimen shall be computed as the difference between the base length (at "0" days drying age) and the length after drying at each test age. Results of the shrinkage test shall be reported to the nearest 0.001 percent. If drying shrinkage of any specimen deviates from the average for that test age by more than 0.004 percent, the results for that specimen shall be disregarded.

2-4. FORMS. Forms shall be designed to produce hardened concrete having the shape, lines, and dimensions indicated on the drawings. Forms shall be substantial and sufficiently tight to prevent leakage of mortar and shall be maintained in proper position and accurate alignment.

Forms for pavement, curbs, or gutters shall be made of steel and shall be supported on thoroughly compacted earth. The top face of pavement forms shall not vary from a true plane more than 1/4 inch in 10 feet [2 mm/m].

Forms shall be thoroughly cleaned and oiled before concrete is placed.

Where concrete is placed against gravel or crushed rock which does not contain at least 25 percent material passing a No. 4 [4.75 mm] sieve, such surfaces shall be covered with polyethylene film to protect the concrete from loss of water. Joints in the film shall be lapped at least 4 inches [100 mm].

2-4.01. Form Ties. Form ties shall be of the removable end, permanently embedded body type, and shall have sufficient strength and rigidity to support and maintain the form in proper position and alignment without the use of auxiliary spreaders.

2-4.02. Edges and Corners. Chamfer strips shall be placed in forms to bevel all salient edges and corners, except the top edges of walls and slabs which are to be tooled and edges which are to be buried. Unless otherwise noted, bevels shall be 3/4 inch [19 mm] wide.

2-4.03. Form Removal. Forms shall not be removed or disturbed until the concrete has attained sufficient strength to safely support all dead, live, and construction loads. Care shall be taken in form removal to avoid surface gouging, corner or edge breakage, and other damage to the concrete.

2-5. REINFORCEMENT. Reinforcement shall be accurately formed and positioned and shall be maintained in proper position while the concrete is being placed and compacted. Unless otherwise indicated on the drawings, the details of fabrication shall conform to ACI 315 and 318. In case of conflict, ACI 318 shall govern. Reinforcement shall be free from dirt, loose rust, scale, and contaminants. Mechanical connections shall be used only as indicated on the drawings.

2-6. BATCHING AND MIXING. Concrete shall conform to ASTM C94 and shall be furnished by an acceptable ready-mixed concrete supplier.

2-6.01. Consistency. The consistency of concrete shall be suitable for the placement conditions. Aggregates shall float uniformly throughout the mass, and the concrete shall flow sluggishly when vibrated or spaded. The slump shall be kept uniform.

2-6.02. Delivery Tickets. A delivery ticket shall be prepared for each load of ready-mixed concrete and a copy of the ticket shall be handed to the Engineer by the truck operator at the time of delivery. Tickets shall indicate the name and location of the concrete supplier, the project name, the mix identification, the quantity of concrete delivered, the quantity of each material in the batch, the outdoor temperature in the shade, the time at which the cement was added, and the numerical sequence of the delivery.

PART 3 - EXECUTION

3-1. PLACEMENT. The Contractor shall inform the Engineer at least 24 hours in advance of the times and places at which he intends to place concrete.

Methods of conveying concrete to the point of final deposit and of placing shall prevent segregation or loss of ingredients. During and immediately after placement, concrete shall be thoroughly compacted and worked around all reinforcement and embedments and into the corners of the forms. Concrete shall be compacted by immersion-type vibrators, vibrating screeds, or other suitable mechanical compaction equipment. The use of "jitterbug" tampers to compact concrete flatwork will not be permitted.

3-2. WATER STOPS. Each water stop shall be continuous throughout the length of the joint in which it is installed. Water stops shall be clean, free from coatings, and shall be maintained in proper position until surrounding concrete has been deposited and compacted.

Junctions between adjacent sections of metal water stops shall be lapped 5 inches [130 mm] and securely bolted, screwed, or spot welded together.

Junctions between adjacent sections of elastomeric (PVC) water stops shall be spliced in strict conformity with the recommendations of the manufacturer. Directional changes and intersections shall be factory fabricated by the water stop manufacturer prior to delivery to the site of the work. Field splices will be acceptable only in straight sections.

3-3. FINISHING. Recesses from form ties shall be filled flush with mortar. Fins and other surface projections shall be removed from all formed surfaces, except exterior surfaces that will be in contact with earth backfill.

Unless otherwise specified, unformed surfaces shall be screeded and given an initial float finish as soon as the concrete has stiffened sufficiently for proper working. Any piece of coarse aggregate which is disturbed by the float or which causes a surface irregularity shall be removed and replaced with mortar. Initial floating shall produce a surface of uniform texture and appearance, with no unnecessary working of the surface.

Initial floating shall be followed by a second floating at the time of initial set. The second floating shall produce a finish of uniform texture and color and the completed finish for unformed surfaces unless indicated otherwise.

3-3.01. Troweling. Interior floor surfaces which will be exposed after construction is completed; exposed top surfaces of equipment bases and interior curbs; and other surfaces designated on the drawings shall be steel trowel finished. Troweling shall be performed after the second floating when the surface has hardened sufficiently to prevent an excess of fines being drawn to the surface. Troweling shall produce a dense, smooth, uniform surface free from blemishes and trowel marks.

3-3.02. Application of Pre-Cure Finishing Aid. Concrete flatwork subject to rapid evaporation due to hot weather, drying winds, and sunlight shall be protected with a pre-cure finishing aid. The finishing aid shall form a monomolecular film on the surface of fresh, plastic concrete to retard evaporation.

Immediately following screeding, pre-cure finishing aid shall be sprayed over the entire surface of fresh, plastic concrete flatwork at a rate of not less than 200 square feet per gallon [4 m²/L], in accordance with the manufacturer's recommendations. The spray equipment shall have sufficient capacity to continuously spray finishing aid at approximately 40 psi [275 kPa] with a suitable nozzle as recommended by the manufacturer.

The sprayable solution shall be prepared as recommended by the manufacturer.

Under severe drying conditions, additional applications of finishing aid may be required following each floating or troweling, except the last finishing operation.

3-3.03. Pavement. Following placement and consolidation, and the disappearance of bleed water, the concrete surface shall be broom finished with a broom acceptable to the Engineer. The broom shall be not less than 18 inches [450 mm] wide and made from good quality bass or bassine fibers not more than 5 inches [125 mm] long. The broom finishing shall produce regular corrugations not over 1/8 inch [3 mm] deep. The broom shall be pulled square across the surface, from edge to edge, with adjacent strokes slightly overlapped, and shall not tear the concrete surface.

The surface of pavements shall not vary more than 1/8 inch [3 mm] under a 10 foot [3 m] straightedge placed parallel to the center line.

3-3.04. Curb and Gutter. Curb and gutter shall be finished to the shape indicated on the drawings. After the forms have been removed, all exposed edges shall be rounded, using an edging tool with a 1/8 inch [3 mm] corner radius. Exposed surfaces shall be float finished and given a light broom finish applied at right angles to the curb at the time of initial set, using a horsehair broom.

3-3.05. Sidewalks. Concrete surfaces shall be screeded to the proper elevation and contour. All aggregates shall be completely embedded in mortar. Screeded surfaces shall be given an initial float finish as soon as the concrete has stiffened sufficiently for proper working. Any piece of coarse aggregate which is disturbed by the float or which causes a surface irregularity shall be removed and replaced with mortar. Initial floating shall produce a surface of uniform texture and appearance, with no unnecessary working of the surface. Initial floating shall be followed by a second floating at the time of initial set.

Floated surfaces shall be given a light broom finish, using a horsehair broom, to provide a nonslip surface. Brooming shall be done at right angles to the length of the walk.

Sidewalks shall be edged using a 3 or 4 inch [75 or 100 mm] wide edging tool with a 1/8 inch [3 mm] corner radius. Edger lap marks at corners of each slab shall be carefully removed. False joints shall be provided at right angles to the length of the walk, using a grooving tool with 1/8 inch [3 mm] radius. The finished edge on each side of the joint shall be the same width as the edging tool used. False joints shall divide each sidewalk into square sections.

The finished surface of all sidewalks shall be neat in appearance, shall be sloped to drain, and shall not pond water.

3-4. CURING. Concrete shall be protected from loss of moisture by water saturation or by membrane curing for at least 7 days after placement; however, when concrete is also being protected from low temperatures, the period of curing by saturation shall be 1 day less than the duration of the low temperature protection.

Water saturation shall be used on concrete which will be covered later with mortar or additional concrete. Water saturation or membrane curing compound may be used on all other concrete surfaces.

Water saturation of concrete surfaces shall begin as soon as possible after initial set. Unformed surfaces shall be covered with polyethylene film, tarpaulins, or sand to retain the water. Water shall be applied as often as necessary to keep the concrete saturated for the entire curing period. Acceptable methods of water curing are described in ACI 308.

Membrane curing compound shall be sprayed at a coverage rate of not more than 300 square feet per gallon [7 m²/L]. Unformed surfaces shall be covered with curing compound within 30 minutes after final finishing. If forms are removed before the end of the specified curing period, curing compound shall be immediately applied to the formed surfaces. Curing compound shall be suitably protected against abrasion during the curing period.

Concrete shall be protected against freezing for at least 8 days after placement.

3-5. EXTERIOR COATING. Water proofing admixtures shall be utilized to prevent water intrusion in lieu of external coatings. Concrete admixtures shall be Xypex, Kryton, or approved equal. Admixture dosage rate shall be in accordance with the admixture supplier's recommendations based on the concrete's environmental exposure.

3-6. REPAIRING DEFECTIVE CONCRETE. Defects in concrete surfaces shall be repaired to the satisfaction of the Engineer. All concrete which is honeycombed or otherwise defective shall be cut out and removed to sound concrete, with edges cut square to avoid feathering.

Concrete repair work shall conform to Article 5.3.7 of ACI 301 and shall be performed in a manner that will not interfere with thorough curing of surrounding concrete. Repair work shall be adequately cured.

3-7. FIELD CONTROL TESTING.

3-6.01. Air Content. An air content test shall be made on concrete from each batch of concrete from which concrete compression test cylinders are made. The Contractor shall provide all equipment and supplies necessary for the testing. Air content shall be determined in accordance with ASTM C231.

3-7.02. Slump. A slump test shall be made on concrete from each batch of concrete from which concrete compression test cylinders are made. Slump shall be determined in accordance with ASTM C143.

3-7.03. Test Cylinders. Compression test specimens shall be made, cured, stored, and delivered to the laboratory in accordance with ASTM C31 and C39. Compressive strength tests will be evaluated in accordance with ACI 318 and as specified herein.

One set of 6 inch [150 mm] diameter by 12 inch [300 mm] concrete test cylinders shall be cast for each concrete pour. A set of test cylinders shall consist of four cylinders, two to be broken and to have compressive strengths averaged at 7 days, and two to be broken and to have compressive strengths averaged at 28 days. All concrete required for testing shall be furnished by, and at the expense of, the Contractor.

The cured cylinders shall be tested by an independent testing laboratory at the expense of the Owner.

End of Section

STRUCTURAL PRECAST CONCRETE

PART 1 - GENERAL

1-1. SCOPE. This section covers the design, fabrication, and erection of prestressed, precast concrete members of hollow core construction for roof and floor applications. For precast concrete wall panels refer to the Architectural Precast Concrete specification section.

1-2. GENERAL. Structural precast concrete members shall be furnished and installed complete with all embedments, accessories, and special construction as specified and as indicated on the drawings.

Layouts and details are based on members of the widths indicated on the drawings. Members with a different standard width will be considered provided that complete layouts and details are furnished to show all modifications necessary to accommodate the substitute product.

1-3. SUBMITTALS. Complete drawings and data covering fabrication, layout, and installation shall be submitted in accordance with the submittals section. All drawings and calculations shall bear the seal of a professional engineer registered in the state the members will be erected in. If the laws of that state require a structural engineer to design the members, then the drawings and calculations shall bear the seal of a structural engineer registered in the state the members will be erected in.

Information to be submitted for review shall include:

Letter or certification from a registered engineer certifying that the product has been designed and constructed in accordance with the Contract Documents.

Details of sections where concentrated loads are to be applied and where boxouts are provided, including saddles, headers, and other special supports.

All dead and live loads used in the design of members as specified on the contract drawings and in the specification.

Reports covering source and quality of concrete materials.

Test reports showing compressive strength of each design mix.

Test reports for required testing during production.

Certification of the Manufacturer by Prestressed Concrete Institute (PCI).

1-4. DELIVERY, STORAGE, AND HANDLING. Prestressed concrete members shall not be damaged during handling and shall be kept from contact with adjacent concrete members.

Members shall be stored on timber skids and leveled to avoid twisting or other undesirable stresses. Members shall not be moved from the Manufacturer's yard until completion of the specified curing period. The open ends of cores shall be protected from the elements to prevent trapping of moisture in the cores. Manufacturer will be responsible for the condition of prestressed members until they are removed from the delivery vehicle at the site.

PART 2 - PRODUCTS

2-1. PERFORMANCE AND DESIGN REQUIREMENTS. Structural precast concrete shall be suitable for the service conditions as specified and as indicated on the drawings. Members, including embedments and accessories, shall be designed in accordance with the following performance and design requirements.

2-1.01. Codes and Standards. Except as otherwise specified herein, design, fabrication, and installation shall comply with all applicable provisions of the following:

2007 Florida Building Code

ACI 318, American Concrete Institute, "Building Code Requirements for Structural Concrete".

PCI MNL-116, Prestressed Concrete Institute, "Manual for Quality Control for Plants and Production of Precast Prestressed Concrete Products".

2-1.02. Fire Rating. Not used.

2-1.03. Performance and Design Requirements. The following requirements shall apply to the prestressed concrete:

The maximum size of aggregate shall be 3/4 inch [19 mm].

The maximum size of prestressing strand shall be 1/2 inch [12.7 mm].

For all members, under dead load conditions (the dead load of the member plus the required superimposed uniform dead load), there shall be no flexural tension in the precompressed tensile zone.

For all members, the maximum flexural tension in the precompressed tensile zone under applied dead load plus live load shall be:

$6 \times \sqrt{f'c}$, psi [$1/2 \times \sqrt{f'c}$, MPa]

Members shall be designed for the following loading:

Dead load – actual

Superimposed DL – 15 psf

Live load – 20 psf, unreduced

Installed camber shall exceed total deflection caused by superimposed dead load and longtime effects of shrinkage and creep.

Adjacent members shall have approximately the same camber.

Immediate deflection of members due to live load shall not exceed span/480.

Members shall have embedments and additional reinforcing to satisfy support and anchorage details.

Manufacturer shall design and detail connections in general accordance with the configurations indicated on the drawings. Connection design shall satisfy all applicable requirements of the building code.

2-2. MATERIALS. Materials for the prestressed members shall be new and free from defects, and shall meet the following requirements unless indicated otherwise on the design drawings. All materials shall be suitable for prestressed concrete construction.

Prestressing Strand	ASTM A416.
Reinforcing Steel	ASTM A615, Grade 60, deformed.
Welded Wire Fabric	ASTM A185 or A497.
Deformed Bar Anchors (DBA)	ASTM A496 with a minimum 70,000 psi [482 MPa] yield strength and minimum 80,000 psi [551 MPa] tensile strength. TRW/Nelson division or equal.
Headed Studs	ASTM A108 with a minimum 50,000 psi [344 MPa] yield strength and minimum 60,000 psi [413 MPa] tensile strength. TRW/Nelson division or equal.
Steel Embedments and Accessories	
Shapes and Plates	ASTM A36, galvanized.
Bolts and Nuts	

High Strength	ASTM A325, Type 1; tested in accordance with Article 9.2 thereof.
Unfinished	ASTM A307.
Nuts, Self-Locking	Prevailing torque type; IFI-100, Grade A.
Washers	
Flat	ASTM F844.
Flat, Hardened	ASTM F436, Type 1.
Lock	ANSI/ASME B18.21.1, helical spring type.
Beveled	ASTM F436, Type 1.
Load Indicator	ASTM F959, compressible-washer type direct tension indicator as manufactured by J&M Turner, Inc.; tested in accordance with Article 10.2 of ASTM F959.
Galvanizing	Hot dipped, G90, in accordance with ASTM A123, A153, and A385.
Concrete	Minimum compressive strength of 5,000 psi [34 MPa] at 28 days.
Cement	ASTM C150, Type I or Type III.
Aggregates	ASTM C33 or C330.
Water	Clean and free from deleterious substances.
Bearing Pads	ANSI/AHA A135.4, Class 1, tempered hardboard
Expansion Joint Filler	ASTM D1752, Type I, preformed sponge rubber, except when indicated otherwise on the drawings.
Mortar (for grouting precast hollow core concrete members)	Minimum compressive strength of 5,000 psi [34 MPa] at 28 days, unless indicated otherwise on the drawings.
Cement	ASTM C150, Type I.
Sand	ASTM C404, natural sharp sand.

Pea Gravel (If used)	ASTM C404, coarse aggregate, 90 percent passing a 3/8 inch [9.5 mm] sieve.
Leveling Mortar	Sika "SikaSet Mortar", unless indicated otherwise on the drawings.
Water	Clean and free from deleterious substances.

2-3. MANUFACTURE.

2-3.01. Configuration. Members shall be rigid, adequately braced, and free from dents, gouges, or other irregularities which would impair the quality, appearance, or performance of the members.

The side edges of cored members shall have a continuous grout key. Side edges shall have a rounded soffit edge unless otherwise approved by ENGINEER.

2-3.02. Release of Tension. The concrete shall attain a compressive strength of at least 3,500 psi [24 MPa] before the pretensioning stress in the prestressing strands is released.

2-3.03. Embedded Accessories. All plates, inserts, and other accessories which are required to be embedded in the members shall be installed at the time of manufacture. All embedded items shall be accurately positioned and shall be rigidly held in position during concrete placement. It is essential that bearing plates be installed in exact and true position.

Prestressed members shall be provided with lifting loops or similar devices to facilitate handling as needed.

2-3.04. Openings and Inserts. Openings for roof ventilators, skylights, roof drains, and other items as indicated on the drawings shall be incorporated into the design and fabrication. The drawings shall be carefully reviewed for the openings and inserts required by the work of all trades, and all openings and inserts which are beyond the limitations of field modification shall be provided by the manufacturer. Side edges of openings shall be formed or cut neatly and shall have vertical surfaces. Saddles, headers, or other suitable supports shall be provided by the manufacturer as necessary for the size and location of openings.

The manufacturer's submittals shall state the limitations for field cutting or modification.

2-3.05. Ends of Strands. Protruding ends of prestressing strands shall be cut off flush with the concrete and coated or finished to prevent rusting.

2-3.06. Surface Finish. The top surface of horizontal members shall be given a smooth float finish unless specifically indicated otherwise on the drawings.

Formed surfaces shall have a smooth uniform texture and color. All fins and other projections shall be removed from formed surfaces, and all holes and other surface defects shall be repaired to the satisfaction of ENGINEER.

2-3.07. Shop Markings. Each member shall have shop markings, painted or labeled at a place not exposed to view after installation, to indicate location and position in the structure in accordance with the manufacturer's layout drawings.

2-3.08. Bearing Pads. Bearing pads shall be used where indicated on the drawings or in accordance with the manufacturer's typical connections details as accepted by ENGINEER.

2-4. CEMENTITIOUS MATERIALS FOR ERECTION.

2-4.01. Topping Slab Concrete. Not used.

2-4.02. Mortar (For Grouting Precast Hollow Core Members). Mortar for grouting precast hollow core members shall be fine or shall be coarse concrete grout meeting the requirements of ASTM C476 (UBC Standard 21-19). Only enough water shall be added to produce a mixture which is flowable, but which will not show an excess of water when placed. Unless otherwise specified, mortar shall have a slump ranging from 8 to 11 inches [200 to 275 mm].

2-5. CURING. Concrete shall be cured by continuous surface saturation or inundation, exposure to steam or saturated air in a tightly closed room or chamber, or other method acceptable to ENGINEER. Moist curing shall be maintained for at least 7 days when Type I cement is used, or 48 hours when Type III cement is used. The steam curing period shall be as needed to reach minimum compressive strength. Members shall be air cured in the fabricator's yard until they attain an age of at least 30 days.

2-6. TOLERANCES. Tolerances for prestressed concrete members shall be as recommended by PCI MNL-116, Division VI.

Prestressed members will be rejected for any of the following:

Length variation in excess of 1/2 inch [12.5 mm] (1/4 inch [6 mm] each end) of adjacent units or 1 inch [25 mm] maximum between the longest and shortest units.

Edges varying in excess of specified tolerance criteria.

Deviation from design camber, differential camber between adjacent members of the same design, or warp or camber which cannot be controlled by the fastening system between members.

Improperly placed accessories or boxouts.

Unsatisfactory surface finish.

Exposure of wire mesh, reinforcing steel, or prestressing strand, except where cut off at the ends.

Honeycomb.

Fractures, cracks, chips, or spalls which cannot be repaired to the satisfaction of ENGINEER.

Irregularities resulting from damaged forms.

2-7. TESTING. Six concrete compression test cylinders shall be cast each day of concreting operations. An additional set of six cylinders shall be cast each time there is a change in the concrete mixture during the day's operations. Control test specimens shall be tested as necessary to determine when to transfer stress from the temporary end anchorage to the bond in the concrete. At least two cylinders from each set shall be tested at an age of 28 days.

Each concrete mixture shall be tested at least once each week, minimum of one test, for water-soluble chloride ion in accordance with ASTM C1218. Maximum water-soluble chloride ion concentrations in prestressed, hardened concrete at an age of 28 days shall not exceed 0.06 percent expressed as a percentage of mass of cement.

PART 3 - EXECUTION

3-1. INSTALLATION. The Installer shall have been regularly engaged for at least three years in the installation of precast structural concrete similar to the requirements of the project. Prestressed concrete members shall be set in position in accordance with the manufacturer's layout and the drawings. Bearing pads shall be installed as indicated on the design and fabrication drawings. Members shall rest solidly upon the supports, without rocking.

3-1.01. Hollow Core Slabs. Members in final position shall be loaded as necessary so that adjacent bottom edges are even, and the grout keys shall be filled with mortar. Mortar dams shall be provided at openings and other locations as necessary to prevent mortar leakage. Leveling loads shall be left in place until the mortar has attained sufficient strength to withstand the shear loads. All mortar that seeps through the joint shall be removed before it hardens.

When all members have been placed, the joints filled with mortar, and the leveling loads removed, the members shall be anchored to the supports as indicated on the drawings.

3-1.02. Double Tee Members. Not used.

3-1.03. Welding. If welded connections are required, welding shall be done by qualified welders possessing valid certificates under the qualification procedures of AWS D1.1. Care shall be exercised to avoid overheating and cracking the concrete adjacent to the anchorage plates. All members damaged during welding shall be removed and replaced by the Installer with new, undamaged members at no additional cost to OWNER.

3-1.04. Field Cutting. Openings, within the manufacturer's limitations and not requiring cutting of prestressing strands, shall be cut in the field by the erector in accordance with the manufacturer's standard recommendations. Openings requiring cutting of prestressing strands shall be made during manufacture; prestressing strands shall not be cut in the field.

All cutting of concrete sections shall be done with suitable concrete saws or core drilling equipment in a manner that will provide smooth, even cut surfaces. Side edges of openings shall have vertical surfaces.

All lifting loops shall be cut off flush with the top surface of the member before any covering materials are placed.

3-1.05. Joints. The soffit of all members shall present a neat and uniform appearance.

When installing hollow core members, cementitious mortar shall be firmly placed by methods which will ensure complete, uniform, and permanent filling of the entire space without disturbing or displacing the adjacent members. Mortar containing pea gravel shall be limited to spaces having one dimension greater than 1-1/2 inches [38 mm].

When insulation is required to be installed directly on the roof slab, all joints shall be checked for unevenness before roofing materials are placed over the prestressed members. Where the top edges of adjacent members deviate more than 1/8 inch [3 mm] from a flush surface, leveling mortar shall be placed along the edge to eliminate the sharp offset. The mortar shall slope uniformly not steeper than 1/2 inch vertically to 12 inches horizontally [10 mm vertically to 240 mm horizontally] from the high edge to the surface of the adjacent member.

The underside of joints that will be permanently exposed to view after the work has been completed shall be caulked. Caulking requirements, and the areas to be caulked, are covered in the caulking section.

3-1.06. Topping Slabs. Not used.

3-1.07. Repairs After Erection. Surfaces damaged during handling or erection, and areas from which fins and projections have been removed, will be repaired to a uniform finish that will blend in with the rest of the member. All repairs shall be accomplished to the satisfaction of ENGINEER.

End of Section

Section 03600

GROUT

PART 1 - GENERAL

1-1. SCOPE. This section covers procurement and installation of grout. Unless otherwise specified, only nonshrinking grout shall be furnished.

Epoxy grouting of anchor bolts, threaded rod anchors, and reinforcing bars is covered in the anchorage in concrete and masonry section. Grouting of masonry is covered in the building masonry section.

1-2. SUBMITTALS. A letter of certification indicating the types of grout to be supplied and the intended use of each type shall be submitted in accordance with the submittals section.

1-3. DELIVERY, STORAGE, AND HANDLING. Materials shall be handled, transported, and delivered in a manner which will prevent damage of any kind. Materials shall be protected from moisture.

PART 2 - PRODUCTS

2-1. MATERIALS.

Nonshrinking Grout	Cementitious grout with demonstrated non-shrinking properties; L&M "Crystex", Master Builders "Masterflow 713" or "Set Grout", Sauereisen "F-100 Level Fill Grout", Sonneborn "SonogROUT 10K", Hilti "CG 200 PC", or Five Star Products "Five Star Grout".
Water	Clean and free from deleterious substances.

2-2. NONSHRINKING GROUT. Nonshrinking grout shall be furnished factory premixed so that only water is added at the jobsite.

PART 3 - EXECUTION

3-1. PREPARATION. The concrete foundation to receive nonshrinking grout shall be saturated with water for at least 12 hours preceding grouting unless additional time is required by the grout manufacturer.

3-2. INSTALLATION.

3-2.01. Mixing. Grout shall be mixed in a mechanical mixer. No more water shall be used than is necessary to produce a flowable grout.

3-2.02. Placement. Unless otherwise specified or indicated on the drawings, grout under baseplates shall be 1-1/2 inches [38 mm] thick. Grout shall be placed in strict accordance with the directions of the manufacturer so that all spaces and cavities below the baseplates are completely filled without voids. Forms shall be provided where structural components of baseplates will not confine the grout.

3-2.03. Edge Finishing. In all locations where the edge of the grout will be exposed to view, the grout shall be finished smooth after it has reached its initial set. Except where shown to be finished on a slope, the edges of grout shall be cut off flush at the baseplate.

3-2.04. Curing. Nonshrinking grout shall be protected against rapid loss of moisture by covering with wet cloths or polyethylene sheets. After edge finishing is completed, the grout shall be wet cured for at least 3 days and then an acceptable membrane curing compound shall be applied.

End of Section

CONCRETE REPAIR

PART 1 - GENERAL

1-1. SCOPE. This section covers the repair of concrete as indicated on the drawings, as specified, or as required to complete the Work. This specification covers the furnishing of all labor, equipment and materials required to repair, rehabilitate or reconstruct spalled, deteriorated, or structurally damaged concrete surfaces. Depth of repairs shall be adequate to restore concrete members to original dimensions.

1-2. SUBMITTALS. Specifications and data covering physical properties, the mixes, application procedures, and curing procedures of the materials proposed shall be submitted in accordance with the Section 01340. Submittals shall include the approvals required from the material manufacturer.

1-3. QUALITY ASSURANCE.

1-3.01. Manufacturer's Field Services. The material manufacturer shall provide engineering field services to review the project and the material application prior to any preparation; to approve the applicator, the material used, and the procedure to be used; to observe surface preparation; to approve surface preparation; and to observe application and curing. The field representative of the material manufacturer shall submit, in writing through the Contractor, approvals of proposed materials, application procedures, applicator, and surface preparation. The field representative shall instruct, as needed, to assure that handling, mixing, placing, finishing, and curing of materials are in accordance with specifications and manufacturer's requirements. The field representative shall be an employee of the material manufacturer.

1-3.02. Materials. Material manufacturer's shall be ISO 9001/9002 registered or provide proof of documented quality assurance. The quality assurance system shall be independent auditing registrar.

1-3.03. Applicator. The repair contractor shall have experience and proficiency specific to the repair type and shall be acceptable to the Engineer and the material supplier. The applicator shall submit, through the Contractor, a satisfactory experience record including references for previous application of the specified materials to concrete structures of similar design and complexity.

1-3.04. Pre-construction Meeting. At least 30 days prior to concrete repairs, the contractor shall conduct a meeting to review the detailed requirements for rehabilitation work. Site conditions, surface preparation, proposed equipment, procedures, material mixing, placing and finishing procedures, and curing methods shall be discussed and approved by the Engineer and by the manufacturer's field representative. The Contractor shall require the attendance of all involved parties, including but not limited to the contractor's superintendent, repair contractor, manufacturer's field representative and proposed equipment supplier representative. Minutes of the meeting shall be recorded, typed and printed by the Contractor and distributed to all parties

within 5 days after the meeting.

1-3.05. Site Conditions. Job conditions shall be maintained at standards that allow material placement within temperature and cleanliness requirements. Unusual conditions as uncovered during the course of work shall be brought to the Engineer's attention for analysis and disposition. These conditions include but are not limited to poor quality base concrete, severely corroded reinforcing steel, random cracks, and deep oil penetration.

1-4. PRE-BID INSPECTION. The Contractor shall visit the site prior to bid submittal to determine the extent of the required repairs. Final bid shall include unit prices for each repair type. Unit prices shall be utilized to adjust the final project cost based on quantities more than or less than the engineering estimate.

1-5. DELIVERY, STORAGE, AND HANDLING. Shipping shall be in accordance with Section 1612; handling and storage shall be in accordance with Section 01614.

PART 2 - PRODUCTS

2-1. ACCEPTABLE PRODUCTS. Concrete repair and restoration products/ materials shall be manufactured by the Euclid Chemical Company, BASF Construction Chemicals, Sika Corporation, or equal as specified herein. Equivalent products of other manufacturers regularly producing high quality concrete and restoration products/ materials, providing engineering field services, and meeting the specified quality assurance requirements may be furnished subject to acceptance by the Engineer.

2-2. MATERIALS. Unless otherwise specified or authorized, materials shall conform to the requirements specified herein. Types of materials or concrete repair not specified herein shall be as specified in other sections, as indicated on the drawings or, in the absence of any definite requirement, as recommended by the manufacturer's field representative and acceptable to the Engineer.

2-2.01. Leveling mortar or surface filler. Applied thickness less than one sixth inch. 1-component or 2-component, polymer-modified, cementitious product.

Emaco R300 CI	BASF
SikaTop 121 Plus	Sika
Or equal	

2-2.02 Horizontal repairs and overlays.

2-2.02.01 Overlay thickness less than one half inch. 1-component or 2-component, polymer-modified, cementitious product.

Emaco R300 CI	BASF
Thin-Top Supreme	Euclid
SikaTop 122 Plus	Sika
Or equal	

2-2.02.02 Overlay thickness greater than one half inch and not exceeding one inch. 1-component or 2-component, polymer-modified, cementitious product.

Emaco R310 CI	BASF
Concrete-Top Supreme	Euclid
SikaTop 122 Plus	Sika
Or equal	

2-2.02.03 Overlay thickness greater than one inch. 1-component, polymer-modified, silica-fume enhanced, cementitious repair product.

Concrete-Top Supreme	Euclid
MonoTop 615	Sika
Or equal	

2-2.03 Vertical or Overhead (Non-sag) Repairs. 1-component or 2-component, polymer modified, cementitious repair mortar.

Verticoat Supreme	Euclid
SikaTop 123 Plus	Sika
Or equal	

2-2.04 Form and Pour. Thickness 6 inch and less. 1-component, silica-fume enhanced, cementitious repair product; shrinkage compensated or polymer modified.

Emaco S66 CI	BASF
MonoTop 611	Sika
Or equal	

2-2.05 Shotcrete or Spray Mortar Repair. Thickness 6 inch and less. 1-component, silica-fume enhanced, cementitious product; fiber reinforced or polymer modified.

Shotpatch 21F	BASF
SikaCem 133	Sika
Or equal	

2-2.06 Penetrating Sealer. Siloxane-based sealer with minimum 10 percent solids. Minimum water repellency 85 percent by ASTM C 642. No scaling exhibited at 125 cycles by ASTM C 672.

Euco-Guard 100	Euclid
Sikagard 701W	Sika
Or equal	

2-2.07 Water. Clean and free from deleterious substances.

2-2.08 Accessory Products.

2-2.08.01 Bonding Agent. Bond repair material to existing concrete. Acrylic latex bonding adhesive.

Flex-Con	Euclid
SikaLatex	Sika
Or equal	

2-2.08.02 Bonding Agent. Protective coating for reinforcing steel and to bond repair material to reinforcing steel. Water-based epoxy resin.

Corr-Bond	Euclid
Armatec 110 EpoCem	Sika
Or equal	

PART 3 – EXECUTION

Unless otherwise specified, the Contractor shall apply all materials in strict accordance with the manufacturer's instructions which are made part of this specification.

3-1. INSPECTION. Prior to the placement of repair material, the surface to be repaired shall be inspected by the material manufacturer's field representative to assure the surface conditions are correct for the type of repair and product/material is being used as specified.

3-2. PREPARATION.

3-2.01 Cleaning. The surface of existing concrete shall be clean and the pores free of any dirt or material that will be detrimental to the bond of the repair material. All oil, dirt, debris, paint, and unsound concrete shall be removed. Cleaning shall include complete removal of all dust, dirt, and residue by high pressure washing.

3-2.02 Surface Preparation. All surfaces shall conform to the requirements of the material manufacturer. All edges shall be square cut to avoid feather edges.

Concrete surfaces shall be clean and rough. As required, surfaces shall be prepared mechanically using a scabber, bushhammer, chipping hammer, shotblast, or scarifier which will give a surface profile of a minimum one-eighth inch and expose the coarse aggregate of the concrete. For overlays, the concrete surface shall be roughened to the profile (CSP-Concrete Surface Profile) and thickness recommended by the International Concrete Repair Institute (ICRI) Publication 03732 .

3-2.03 Cracks. All cracks shall be repaired. See Section 03710.

3-2.04 Inspection and Replacement of Reinforcing Steel. Any exposed reinforcing steel shall be excavated to the extent that a minimum of three-quarter inch of clear space is provided all around the steel to allow placement of repair material.

Replace any reinforcing steel that has corroded to the extent that the cross-sectional area at any point has been reduced more than 20 percent from the original cross-section.

3-3. APPLICATION. Concrete repair work shall be performed in accordance with the following requirements.

3-3.01 Bonding and Priming. Bonding agent shall be applied per manufacturer's recommendations. The manufacturer's coverage rate shall be followed. For rough surfaces, scrub bonding agent into the surface with a stiff broom.

3-3.02 Treatment of Reinforcing Steel. All reinforcement which is loose, shall be secured in its proper position by tying to other secured bars.

Place new reinforcing steel into repair cavity. Unless approved otherwise by the Engineer, new reinforcing steel shall be lap spliced to existing reinforcing.

Reinforcing shall be treated with two coats of anti-corrosion bonding agent.

3-3.03 Forming. Where forms are required, water-tight forms shall be constructed with sufficient rigidity to withstand head pressure and prevent excessive deflection during material placement. For pumped applications without open top forms, provide a port connection of sufficient diameter to allow pumping into the form.

Tolerances for formed work shall be as stipulated in ACI 117 for cast-in-place concrete, unless otherwise indicated. Formed surfaces stipulated in Article 3.4 of ACI 347 shall be Class C.

3-3.04 Shotcrete Repairs. Shotcrete or spray mortar materials shall be applied per ACI 506.2 and the recommendations of ACI 506. The material shall have a minimum thickness of one-half inch.

3-3.05 Shoring and Support. When removal and patching of deteriorated concrete may cause temporary weakness, excessive deflections, or structural instability, shoring or other suitable supports shall be provided until completion and adequate curing of repairs.

3-4 FINISHING. All unformed surfaces shall receive a light broom finish.

3-5 CURING. Curing procedures are required to ensure the durability and quality of the repair. The repair material shall be cured as recommended by the manufacturer before being placed in service.

Unless specified otherwise, one or more of the following methods shall be used:

3-5.01 Water Curing. Keep concrete surfaces continuously wet with water during the curing period by immersion, maintaining a continuous flow of water over the surface, continuous spraying, continuous sprinkling, or a combination of these. The difference in temperature between the water used for curing and the concrete shall not exceed 20 degrees F. The curing period shall be a minimum of ten days.

3-5.02 Wet Coverings. Cover the surfaces with burlap, cotton mats, sand, earth, or other

suitable moisture retaining materials and keep these materials fully saturated during the curing period. Lap all coverings at least 8 inches at all joints. Do not use any type covering which will discolor the repair or the surrounding surfaces. The curing period shall be a minimum of ten days.

3-5.03 Membrane Curing Compounds. Unless required by the material manufacturer, membrane curing compounds shall not be used.

3-6. FIELD QUALITY CONTROL.

3-6.01 Material Storage and Handling. The material shall be delivered in original, unopened containers. Containers shall be labeled with the manufacturer's name, product name, and lot number. Materials shall be stored at the job site under dry conditions and at temperatures between 50 deg F and 90 deg F.

3-6.02. Environmental Conditions. Repair materials shall not be applied without protection in temperature below 45 deg F nor when the temperature is expected to fall below 45 deg F during the curing period, unless otherwise specified by the material manufacturer.

When ambient temperatures below 45 deg F are expected during the curing period, the repair shall be maintained at 50 deg F for the full curing period. Sudden cooling shall not be permitted. Gradual temperature drop shall be maintained at not more than 20 deg F in any 24 hour period. Carbon dioxide or exhaust gases from combustion heaters shall not be allowed within enclosures or allowed to contact the repair.

3-6.03. Protection. Repair areas shall be protected from other trades and weather for a minimum of 10 days after material is placed.

3-6.04. Cleaning. Work areas are to be cleaned each day in accordance with Section 01710. Upon completion of the final cleanup, the Contractor shall restore all areas affected by repair procedures to their original condition, leaving no trace of material piles or other wasted materials.

End of Section

CONCRETE CRACK REPAIR

PART 1 - GENERAL

1-1. SCOPE. This section covers the repair of concrete and shotcrete cracks and joints.

The Work covered by this section includes, but is not limited to, the following:

- a. Sealing of all cracks and crack networks that are wider than a minimum thickness of 10 mils (0.01 inch) [250 µm].
- b. Sealing of construction and movement joints that require repair.
- c. If a liquid-containing structure fails the leakage test, CONTRACTOR shall make repairs to the structure to stop all leaks. Repairs shall include all repairs necessary to achieve an acceptable leakage test.

Both inch-pound (English) and SI (metric) units of measurement are specified herein; the values expressed in inch-pound units shall govern.

1-2. SUBMITTALS. Specifications and data covering physical properties, mixtures, application procedures, and curing procedures of the materials proposed shall be submitted in accordance with the submittals section. Submittals shall include the approvals from the material manufacturer.

1-3. QUALITY ASSURANCE.

1-3.01. Manufacturer's Field Services. The material manufacturer shall provide engineering field services to review the project and the material application prior to any preparation; to approve the applicator, the material used, and the procedure to be used; to observe surface preparation; to approve surface preparation; and to observe application. The field representative of the material manufacturer shall submit, in writing through CONTRACTOR, approvals of proposed material, application procedures, applicator, and surface preparation. The field representative shall be an employee of the material manufacturer.

1-3.02. Applicator. The applicator shall submit through CONTRACTOR a satisfactory experience record including references from previous application of the specified materials to structures of similar design and complexity.

1-4. DELIVERY, STORAGE, AND HANDLING. Shipping shall be in accordance with the shipping section. Handling and storage shall be in accordance with the handling and storage section.

PART 2 - PRODUCTS

2-1. PERFORMANCE AND DESIGN REQUIREMENTS. Unless otherwise specified or authorized, repairs shall conform to the requirements specified herein. Types of repairs not specified herein shall be as specified in other sections, as indicated on the drawings, or, in the absence of any definite requirement, as recommended by the manufacturer's representative and subject to acceptance by ENGINEER. The following types of repairs shall be performed as required.

2-1.01. Pressure-Injected Epoxy Resin. Pressure-injected epoxy resin shall be used to seal cracks, construction joints, and other repairs in concrete and shotcrete structures as required or as directed by ENGINEER.

2-1.02. Pressure-Injected Foam Resin. Pressure-injected foam resin shall be used to seal joints and cracks in concrete and shotcrete structures that will have movement as required or as directed by ENGINEER.

2-1.03. Crack Sealant. Crack sealant shall be used to seal cracks in structures prior to pressure injection of resin.

2-2. ACCEPTABLE PRODUCTS. Repair products/materials shall be manufactured by the companies specified herein. Equivalent products of other manufacturers regularly producing high quality concrete repair products/materials and providing engineering field services may be furnished subject to review and acceptance by ENGINEER.

2-3. MATERIALS. All materials shall be as specified or as recommended by the manufacturer for temperature and moisture conditions encountered.

Pressure-Injected Epoxy Resin	ASTM C881, Type IV, moisture insensitive, maximum viscosity 350 cps at 77°F [25°C]. Sika "Sikadur 52", Master Builders "Concresive 1380", PolySpec "RezRok 107", Prime Resins "Prime Rez 1000".
Pressure-Injected Foam Resin	Prime Resins "Prime-Flex 900", DeNeef "HA Sealfoam", or 3M "ScotchSeal 5600"..
Foam Resin Accelerator	As recommended by foam resin manufacturer.
Crack Sealant	Master Builders "Concresive Paste LPL", Sika "Sikadur Hi-Mod Gel", or PolySpec "TuffRez 106", moisture insensitive.
Epoxy Bonding Agent	Master Builders "Concresive Liquid LPL", Sika "Sikadur Hi-Mod Adhesive", or PolySpec "TuffRez 101", moisture insensitive.
Water	Clean and free from deleterious substances.

PART 3 - EXECUTION

3-1. INSPECTION. Prior to the placement of the repair materials, the crack to be repaired shall be inspected by the material manufacturer to assure that preparation and conditions are correct for the type of repair and the product/material being used as specified herein.

3-2. PREPARATION. All cracks and surfaces around the cracks shall be free of objectionable substances and shall conform to the requirements of the material manufacturer. Concrete and shotcrete to be repaired shall be cleaned by methods acceptable to the material manufacturer so that the cracks are free of dirt, oil, grease, laitance, and other foreign matter. All loose and deteriorated existing concrete and shotcrete shall be removed down to sound materials. All concrete and shotcrete surfaces shall be checked for delamination to ensure that all surfaces are sound. All edges shall be square cut to avoid feather edges.

Any other preparation recommended by the material manufacturer shall be brought to ENGINEER's attention and may be incorporated into the work if acceptable to ENGINEER.

Concrete and shotcrete surfaces in the area of a crack to be repaired shall be cleaned by wire brushing, blasting, or other acceptable methods.

Wall surfaces shall be sandblasted clean to expose crack networks and construction joints. If there is active water seepage in the repair area, the seepage shall be stopped as recommended by the injection material manufacturer and as acceptable to ENGINEER. Injection ports shall be installed, when recommended by the injection material manufacturer.

3-2.01. Injected Epoxy Resin. Preparation for injected epoxy resin shall include sealing the surface at the crack on both sides, when possible, with crack sealant as recommended by the material manufacturer and as acceptable to ENGINEER for the pressure injection work. Injection ports for epoxy resin shall penetrate through the crack sealant into the cracks at spacings recommended by the material manufacturer.

3-2.02. Injected Foam Resin. Preparation for injected foam resin shall include drilling offset injection holes at an angle that will intersect the crack, joint, or crack network at approximately one-half the thickness of the concrete or shotcrete up to a thickness of 36 inches [900 mm]. Spacing of injection ports shall be determined as recommended by the injection material manufacturer and as acceptable to ENGINEER. When the injection material manufacturer certifies, in writing, that spacing of injection ports and installation procedures are acceptable, the injection ports may be installed directly into the crack, subject to review by ENGINEER.

3-3. APPLICATION. Concrete and shotcrete repair work shall be performed in accordance with the following requirements.

3-3.01. Crack Sealant. Crack sealant shall be trowel-applied to a minimum dried thickness of 1/8 inch [3 mm]. The concrete surface where the sealant is applied shall be smooth, uniform, and free from irregularities. Crack sealant shall be removed after the injection of resin is completed whenever the sealant will be visible after completion of the work.

3-3.02. Pressure-Injected Resin. The injected areas shall be prepared as specified and as recommended by the manufacturer. Pressure-injected resin shall be suitable for penetration of joints, cracks, and crack networks 2 mils (0.002 inch) [50 µm] wide and larger.

After the joints and cracks are prepared and before the injection of the resin, the joints shall be flushed with water. The water flush shall be terminated when the turbidity of the expelled water is equal to that of the flush water.

The pumping equipment used for the pressure injection of resin shall have pressure metering. Written procedures for use and quality control of the injection equipment shall be furnished to ENGINEER for review and acceptance. The pump shall be electric. The material and process used for the pressure injection of the resin shall have been in use a minimum of 5 years.

The joints and crack networks shall have a minimum of 90 percent penetration of resin into the joint or crack network. Core samples may be taken at ENGINEER's discretion.

3-3.02.01. Epoxy Resin. Epoxy resin shall be injected into the structure in accordance with the material manufacturer's recommendations and as acceptable to ENGINEER. Epoxy resin shall be injected until the resin appears at the next port.

3-3.02.02. Foam Resin. Foam resin shall be premixed and injected into the structure in accordance with the material manufacturer's recommendations and as acceptable to ENGINEER. Foam resin shall be injected into the structure until the resin appears at the next injection port.

Surfaces of cracks and joints may need to be sealed with crack sealant.

3-3.03. Cold Weather. When ambient temperatures below 40°F [4°C] are expected during the curing period, the repair materials shall be maintained at a temperature of at least 50°F [10°C] for 14 days or 75°F [24°C] for 7 days after placement. Sudden cooling of the repair materials shall not be permitted.

3-4. PROTECTION. Post-placement curing and protection shall be as specified herein and in accordance with the manufacturer's recommendations.

3-5. CLEANING. Work areas shall be cleaned each day in accordance with the project requirements section. Upon completion of the final cleanup, CONTRACTOR shall restore all areas affected by the grouting procedures to their original condition, leaving no trace of material piles or other wasted materials.

End of Section

BUILDING MASONRY

PART 1 - GENERAL

1-1. SCOPE. This section covers the furnishing and installing of building masonry.

1-2. GENERAL. Building masonry shall be constructed of units of the types, dimensions, arrangements, and coursing indicated on the drawings and specified herein, complete with all materials, accessories, and appurtenances indicated and specified.

1-3. DELIVERY, STORAGE, AND HANDLING. Shipping shall be in accordance with the Shipping section. Handling and storage shall be in accordance with the Handling and Storage section.

All masonry units shall be handled in a manner which will prevent soiling, chipping, or damage of any kind. Broken, discolored, chipped, or otherwise damaged facing units will be rejected and shall be replaced with undamaged units.

Masonry units shall be stored on pallets, shall be protected against contamination and staining, and shall be kept covered and dry at all times. Lime and cement shall be stored under cover in a dry place.

Sand shall be stored so that the inclusion of foreign materials is prevented. Whenever sand is piled directly on the ground, the surface beneath the sand shall be smooth, well drained, and free from dust, mud, and debris. The bottom 6 inches [150 mm] of each pile shall not be used in mortar.

1-4. SUBMITTALS. Before masonry construction is begun, the following drawings, data, specimens, and samples shall be submitted in accordance with the Submittals section. Additional data shall be submitted as needed. If the source of a material is changed during the course of the work, the tests and reports required for preliminary review of that material shall be resubmitted.

Specimens, performance data, and color selection kits for all masonry units which will be used in project construction, showing range of colors, textures, finishes, and dimensions.

Manufacturer information and data for any admixture, mortar coloring, or product added to the grout or mortar.

Color selection sample kits for integral mortar colors.

One sample, at least 6 inches [150 mm] long, of each type of nonmasonry joint material required.

Shop drawings or manufacturers' literature showing details of anchors, ties, and metal accessories to be used in masonry construction.

Bar lists and drawings for the fabrication and placement of reinforcement with sufficient elevations and sections to adequately detail and label all

reinforcement.
Setting drawings covering marble, granite or cut stone.
Cold and hot weather construction procedures.
Certificates for the following materials used in masonry construction, indicating compliance with the standards herein. Verification of f'm will be required every 5000 square feet during construction of essential facilities.
Masonry units.
Mortar and grout materials.
Reinforcement.
Anchors, ties, fasteners, and metal accessories.

For each mortar mix, one of the following:

Mix designs indicating type and proportions of ingredients in compliance with the proportion specification of ASTM C270.

Mix designs and mortar tests performed in accordance with the property specification of ASTM C270.

For each grout mix, one of the following:

Mix designs indicating type and proportions of ingredients in compliance with the proportion requirements of ASTM C476.

Mix designs and grout strength tests performed in accordance with ASTM C476.

1-5. COLORS AND SAMPLES. Colors of masonry units and colored mortar will be selected from manufacturers data and samples after the award of the contract.

1-5.01. Masonry Units. Colors for integral colored masonry units shall be selected from manufacturers standard and custom color selections. Different colors may be required for each type of masonry unit or for different locations of the same type of masonry unit. Special color patterns shall be as indicated on the drawings. General color selections shall be made from manufacturer's data.

1-5.02. Marble and Granite. Not used.

1-5.03. Limestone. Not used.

1-5.04. Glass Block. Not used.

1-5.05. Mortar. When integral mortar color is required, color will be selected from sample kits submitted. After general color selections have been made, mortar samples shall be prepared for color selection. As many samples as are necessary to make a proper selection shall be prepared. Preliminary color selections shall be used in constructing the sample panels. Mortar colors shall not be final until the sample panels have been accepted.

1-5.06. Samples. Samples of all masonry units and mortar shall be submitted as indicated in the Submittals section. At least two samples of each type of unit required shall be submitted.

1-5.07. Sample Panels. Not used.

1-6. BRICK ALLOWANCE. Not used.

1-7. UNIT STRENGTH METHOD. The design compressive strength of masonry, f_m shall be based on the unit strength method.

Masonry construction shall not begin until Engineer has reviewed the applicable submittals for strength of masonry units and mortar.

PART 2 - PRODUCTS

2-1. MATERIALS. All acceptable masonry products are indicated below. Products necessary for the work are as specified or as indicated on the drawings. Sizes of masonry units are nominal, the actual size being slightly smaller to allow for mortar joints.

Concrete block	ASTM C90, (UBC Standard 21-4), 8 inch x 16 inch [200 mm x 400 mm] face dimensions, sizes with special shapes as indicated on the drawings; lightweight or regular aggregate conforming to ASTM C331 or C33.
Split face type	Integral color units or as indicated on the drawings with integral moistureproofing admixture; full face units with special corner units, bond beam units, and other required special units as indicated on the drawings.
Color range	Tans
Texture	Random broken face
Scoring	No score
Sand	ASTM C144, natural sand; 95 percent passing No. 16 [1.18 mm] sieve.
Pea Gravel	ASTM C33, coarse aggregate, 90 percent passing 3/8 inch [9.5 mm] sieve, 90 percent retained on No. 4 [4.75 mm] sieve.
Portland Cement	ASTM C150, Type I.
Hydrated Lime	ASTM C207, Type S.
Quicklime	ASTM C5, pulverized.
Lime Putty	Quicklime, thoroughly slaked and stored for one day; kept moist until used.
Integral Mortar Color	ASTM C979, mineral pigments, natural or synthetic iron oxides, sun fast and water resistant, free of fillers and extenders. Soloman Grind-Chem Service, Inc. "A", "H", or "X" series.

Integral Waterproofing	Aluminum stearate, ammonium stearate, or calcium stearate, 2 percent of weight of cement; W. R. Grace "Dry Block Mortar Admixture", A. C. Horn "Hydratite", or Sonneborn "Hydrocide".
Prepared Joint Filler	ANSI A118.6 Sanded tile grout. Laticrete Series 500 joint filler, Bonsal "Sanded Grout" or Bostik "Hydroment Joint Filler".
Water	Clean and free from deleterious substances.
Joint Reinforcement	Dur-O-Wall or Hohmann and Barnard; fabricated from cold drawn steel wire, ASTM A82; galvanized, ASTM A153, Class B-2; type as indicated on the drawings with prefabricated corners and tees.
Ladder Type	Two-rod and three-rod types as indicated on the drawings.
Standard Weight	9 gage [3.80 mm thick] side rods and cross rods.
Thin Joint	11 gage [3.04 mm thick] side rods and cross rods.
Rebar Positioner	9 gage [3.80 mm thick] wire, sized for block thickness, single or double bar type, galvanized ASTM A153, Class B-2.
Cramp Anchors	Carbon steel, galvanized in accordance with ASTM A153, Class B-2, 1/4 x 1-1/4 inches [6 x 31 mm], at least 6 inches [150 mm] long, with bent-up ends.
Reinforcing Steel	ASTM A615, Grade 60, except No. 3 [9.5 mm] bars which may be either Grade 40 or Grade 60, deformed.
Loose Fill Insulation	Granular perlite, ASTM C549, or vermiculite, ASTM C516, treated for water repellency; Grace "Zonolite" or Frefco "Permalite".
Control Joint Material	ASTM D1056, Type 2, Class A-1, PVC foam with pressure-sensitive adhesive back; Dur-O-Wall "Rapid Soft-Joint" or Hohmann & Barnard "NS" Neoprene.
Preformed Control Joint	ASTM D2287, PVC Synthetic rubber; Dur-O-Wall "Rapid Control Joint" or Hohmann & Barnard "VS" Series.

Detergent Masonry Cleaner

ProSoCo "Vana-Trol" or National Chem-Search "DC-6", unless otherwise recommended by the masonry unit manufacturer and accepted by Engineer.

Wall flashings are covered in the Sheet Metal section.

2-2. MORTAR. The method of measurement of all mortar ingredients shall be accurate and shall ensure definite and uniform proportions. All mortar ingredients shall be mixed on site. The use of masonry cement or premixed ingredients will not be acceptable, unless authorized by Engineer.

2-2.01. Masonry Mortar. Masonry mortar shall conform to ASTM C270, except as modified herein. Mortar shall be machine mixed for at least 5 minutes and shall be used within 90 minutes after mixing. Mortar left when work is stopped shall be discarded. Remixing of mortar more than 90 minutes old with additional water, cement, or other materials will not be acceptable.

Unless otherwise indicated, mortar shall be cement-lime Type S, and shall conform to the proportion specifications of ASTM C270.

The sand content specified above is maximum quantity. Integral waterproofing shall be added to each mortar mixture.

2-2.02. Integral Mortar Color. Integral mortar coloring shall be added to the mortar for masonry as specified herein. All other joints shall be standard gray mortar. Integral mortar coloring shall be added to the mortar mix as recommended by the mortar color manufacturer. The manufacturer's mixing instructions and proportions shall be strictly adhered to. Each mortar color shall be of consistent color throughout the project. Mortar shall be mixed in a power mixer until a uniform color is obtained, but not less than 5 minutes.

2-3. GROUT FILL. Grout fill for filling bond beams and other reinforced masonry shall be concrete grout meeting the requirements of ASTM C476 . Grout shall be coarse and shall be proportioned by volume in accordance with Table 1 of ASTM C476. Only enough water shall be added to produce a mixture which is flowable, but which will not show an excess of water when placed. Unless otherwise specified, grout fill shall have a slump ranging from 8 to 11 inches [200 to 275 mm].

PART 3 - EXECUTION

3-1. MORTAR JOINTS. Masonry shall be laid in straight, level, uniform courses, with mortar joints of uniform width. Head joints shall approximately equal the horizontal joints in width.

Additional mortar shall be placed in the upper part of the head joint and sufficient pressure exerted to force it out the full depth of the joint. In laying up concrete block, abutting surfaces of head joints shall be completely and solidly cemented together with mortar. All solid masonry units and hollow units with horizontal cells shall be laid on a full bed of mortar. All unfilled

hollow masonry units with vertical cells shall be laid with face shell mortar bedding, except that starter courses shall be laid on a full bed of mortar. Web joints of all cores which will be subsequently filled with grout fill shall be fully mortared. Walls which are to be fully grouted may be laid with face shell bedding.

The filling of masonry joints shall mean that the entire space between abutting surfaces of units is full, and that the body of the mortar is forced against and into the porous surface of each unit.

All exterior and exposed interior mortar joints shall be tooled to a smooth uniform surface and shall be finished free of voids using a rounded tool. Mortar joints specified to be caulked shall be raked to a depth of 1/2 inch [12.7 mm]. Tooling of joints shall be regulated so that the mortar for each wall space has a uniform appearance.

3-2. **BONDING AND REINFORCING.** Except where otherwise indicated on the drawings, all concrete block shall be laid in running bond. All masonry shall be reinforced and anchored as indicated on the drawings and as specified herein.

3-2.01. **Joint Bonding and Reinforcing.** Horizontal masonry units shall be bonded and reinforced as specified, unless otherwise indicated on the drawings. Joint reinforcing shall be discontinuous at control and expansion joints. Prefabricated corner and tee pieces shall be used at corners and tees indicated to be continuous on the drawings.

Unless otherwise specified, all concrete block masonry shall be bonded and reinforced with continuous ladder type joint reinforcement spaced not more than 16 inches [400 mm] apart vertically. The joint reinforcement shall have one longitudinal rod at each face shell of the masonry units. Continuous ladder type joint reinforcement may be omitted in concrete block walls with reinforced bond beams at not more than 24 inches [600 mm] on centers.

Adjustable type reinforcement may be used only if specifically indicated on the drawings.

Masonry parapets shall be reinforced with heavy-duty continuous joint reinforcement or reinforcing steel as indicated on the drawings.

Except where a top bond beam is indicated on the drawings, the top three courses of all masonry walls, including backup, shall have continuous joint reinforcement placed in each joint (8 inch [200 mm] on centers). Joint reinforcement shall be terminated at expansion joints and control joints. Openings in masonry walls shall have joint reinforcement placed in the two courses immediately above lintels and in the two courses immediately below all sills. Joint reinforcement shall extend 24 inches [600 mm] past openings on each side.

The width of joint reinforcement (side rod to side rod) in each case shall be approximately 2 inches [50 mm] less than the nominal overall thickness of the wall in which it is placed. All joint reinforcement shall be fully embedded in mortar and shall be covered with at least 5/8 inch [15 mm] of mortar on the exterior face.

The ends of sections of joint reinforcement shall be lapped at least 8 inches [200 mm]. At corners and intersections, prefabricated corners and tees shall be used.

3-2.02. Masonry Anchorage. Not Used.

3-2.03. Reinforcing Steel. Concrete block bond beam units shall be provided, installed and reinforced with reinforcing steel where required and as indicated on the drawings. Bond beam units shall be filled with grout fill as specified herein. Reinforcing steel shall be continuous around corners. At expansion joints, all bond beam reinforcing shall be discontinuous. At control joints, 50 percent of the bond beam reinforcing shall be discontinuous unless otherwise indicated on the drawings.

Vertically reinforced concrete block cores shall be provided as indicated on the drawings. Reinforcing shall be accurately placed and securely tied to prevent shifting during core filling. Bar positioners shall be used for alignment. Positioners shall be placed in the bottom and top courses of walls and at not more than 4 feet [1,200 mm] centers between. Mortar fins which project into cores more than 1/2 inch [13 mm] and all loose mortar and debris shall be removed before filling the cores. Cores shall be filled with grout fill as specified herein.

When accepted by Engineer, open-ended concrete masonry units may be substituted for units with end webs in reinforced concrete masonry walls.

Special bond beam units with open or knockout webs and open vertical cells shall be used for bond beams. U-shaped lintel units shall be used only in bond beams over openings. If the cells beneath a bond beam are not required to be grouted, wire mesh material may be used in the joint to retain the grout fill.

3-2.04. Grout Fill. Unless otherwise acceptable to Engineer, grout fill shall be placed in lifts not to exceed 5 feet [1.5 m]. Pours exceeding 12 inches [300 mm] in height shall be consolidated by mechanical vibration and reconsolidated after initial water loss and settlement. Bond beam fill shall not be mechanically vibrated. Grout fill shall be placed in reinforced block cores, bond beams, lintels, and in other locations indicated on the drawings.

All concrete block masonry in Seismic Risk Zones 3 and 4 or in Seismic Categories C, D, or E shall be grouted solid.

3-3. LAYING MASONRY UNITS. All masonry units shall be free from dust, dirt, and surface moisture when laid. Concrete blocks shall be dry when laid.

All masonry shall be laid to a line. Walls shall be plumb and straight and in level courses. At no time shall any part of masonry construction project more than 8 feet [2.4 m] above adjacent work. When work is suspended, the tops of exterior masonry walls shall be covered and protected from the weather.

Care shall be taken in corner construction and at jambs to maintain uniformity of appearance and to ensure that only whole, undamaged units are used. All patterned masonry units shall have special corner units installed at exposed corners to maintain consistency of patterns.

Unless otherwise indicated on the drawings, concrete block shall have bullnose units installed at door jambs, louver jambs and sills, and all exterior corners.

Unless otherwise indicated, masonry units laid in running bond in exposed locations shall be so constructed that vertical joints in alternate courses lie in the same vertical lines, midway between the vertical joints in adjacent courses to provide a regular and uniform joint pattern.

Masonry units shall be saw-cut to provide openings and to accommodate embedded items. Anchors shall be securely embedded in mortar. Door frames shall be maintained plumb and true. A caulking space shall be provided between exterior door frames and masonry in accordance with the details indicated on the drawings. The jambs of built-in hollow metal door frames shall be completely filled with grout fill or mortar.

Lintels shall be provided over all openings wider than the length of a masonry unit. Lintels shall be of the types and sizes indicated on the drawings or as needed, and shall be acceptable to Engineer. Lintels longer than 3 feet [900 mm] shall bear on solid masonry units or on grout-filled cells of hollow units at least one masonry course in height, unless otherwise indicated on the drawings.

Reinforced lintels and other wall reinforcing as needed and indicated on the drawings shall be provided and installed hereunder. Reinforced lintels shall be filled with grout fill.

All embedded items shall be set and securely anchored in the masonry work as indicated on the drawings or as acceptable to Engineer. Joints between masonry and embedded items shall be pointed.

Where indicated on the drawings, the unfilled cores of concrete block walls shall be filled with loose insulation, under section 2.1. The insulation shall be poured into the space as the work progresses, with care taken to fill all spaces and voids.

Masonry units shall be selected and laid so that the exposed face of each unit is free of broken corners, chipped edges, or other defects which would be detrimental to the appearance of the wall surface.

3-4. FLASHINGS. Wall flashings shall be installed where and as indicated on the drawings. Flashings in horizontal joints shall be in the center of the joints, with mortar below and above them and shall extend to within 3/8 inch [9 mm] of the exterior masonry face unless otherwise indicated on the drawings. Flashings shall drain toward the exterior surface of the wall.

Flashings shall be kept from actual contact with steelwork.

3-5. EXPANSION AND CONTROL JOINTS. Expansion and control joints in masonry walls shall be constructed as indicated on the drawings. Where indicated on the drawings, preformed control joint strips shall be placed in the wall as construction proceeds, with masonry units laid tight against the strips. Where required, joint filler strips shall have a thickness equal to at least 1-1/2 times the nominal width of the joint. The filler strips shall be firmly bonded to one joint face by the adhesive backing, and shall be of required width to be held back 1/2 inch [13 mm] from each face for caulking, and placed under compression by the abutting masonry. All joints in filler strips shall be tightly butted.

3-6. ANCHORS, INSERTS, AND OTHER PENETRATIONS. All necessary ties, anchors, bolts, inserts, bucks, flashings, sleeves for piping, conduits of every kind, door frames, and other work shall be accurately set and securely held in the masonry work as indicated on the drawings or in a manner acceptable to Engineer. Sleeves shall be provided where small piping passes through the masonry.

3-7. LOW TEMPERATURES. When the temperature of the surrounding air is below 40°F [4°C], or when the outdoor temperature is likely to fall below freezing at any time during the 24 hour day, the following precautions shall be taken to prevent freshly laid masonry from freezing:

- a. In addition to the protection specified for ordinary conditions, masonry materials shall also be kept from contact with snow, ice, or dampness of any kind.
- b. The temperature of the mixed mortar shall be between 70 and 120°F [21 and 49°C]. Mixing water shall be warm, but not above 165°F [74°C]. If necessary, sand shall be heated also. Mortar mixing equipment shall be heated before it is used. The use of salt or calcium chloride is not acceptable.
- c. Masonry units shall be free of ice and snow and shall be above freezing when laid. If the outdoor temperature is below 30°F [-1°C], units shall be heated to at least 40°F [4°C]. If the temperature is below 0°F [-17°C], units shall be heated to at least 60°F [15°C]. Heating shall be done so that the units are not damaged.
- d. Masonry units shall not be laid on surfaces that are frozen or covered with snow or ice.
- e. Masonry laid during freezing weather shall be kept warm for at least 3 days after laying. The air temperature at the masonry surface shall be kept between 45°F and 90°F [7°C and 32°C], using heating methods that will not unduly dry out or otherwise damage the masonry. Heat shall be applied to both sides of the wall, with provisions for proper circulation of air. The masonry shall be suitably housed or covered.

3-8. HIGH TEMPERATURES. When the ambient air temperature exceeds 99°F [37°C] in the shade and the relative humidity is less than 50 percent, masonry shall be protected from direct exposure to wind and sun during and for 48 hours after erection.

3-9. FINISH TUCK POINTING. On completion of the work, all exposed masonry shall be pointed where necessary and all voids and holes in the mortar shall be filled to match adjacent joint surfaces. Defective joints shall be cut out and repointed with mortar. Care shall be taken to produce a uniform overall appearance. Spottiness due to variations in either materials or workmanship will not be acceptable.

3-10. PAVING BRICK. Not used.

3-11. PROTECTION FROM DAMAGE. Masonry and all embedded or built-in items shall be carefully protected from damage. Masonry walls discolored by paint, mortar, or concrete shall be rebuilt with new materials.

Where concrete is placed adjacent to or on top of previously constructed masonry, the masonry shall be adequately protected against splashing of concrete paste and from other damage.

3-12. CLEANING. Following finish pointing, all exposed masonry surfaces shall be cleaned to remove all surface stains and smears.

Mortar smears or droppings on concrete blocks shall be removed with a steel trowel after they have hardened to the extent that removal will not cause additional smearing. Any remaining mortar shall be removed to the extent possible by rubbing with a small piece of block. All surfaces shall then be thoroughly brushed.

If stains and smears cannot be removed by the specified methods, Contractor may propose alternative methods or cleaning products. These alternatives shall be acceptable to Engineer before they are used.

3-13. OWNER'S FIELD CONTROL TESTING. When required, field control tests will be performed by Engineer or a testing laboratory. Contractor shall provide all facilities and the services of one or more employees as necessary to assist with the field control testing.

As stipulated in the Quality Control section, tests required during the progress of work will be made at the expense of Owner.

The frequency specified for each field control test is approximate and subject to change as determined by Engineer.

3-13.01. Clay Masonry Units. Not Used.

3-13.02. Concrete Masonry Units. Concrete masonry units from work site stockpiles will be tested in accordance with ASTM C140 at the rate of three specimens per 5,000 square feet [465 m²] of wall. Alternatively, prisms may be constructed and tested in accordance with ASTM C1314 modified in accordance with ACI 530.1 (UBC Standard 21-17) at the rate of three specimens per 5,000 square feet [465 m²] of wall.

3-13.03. Grout. Grout sampled during placement will be tested in accordance with ASTM C1019 (UBC Standard 21-18) at the rate of three specimens per 5,000 square feet [465 m²] of wall. Compressive strength test shall be at 28 days after sample collection. Alternatively, grouted prisms may be constructed and tested in accordance with ASTM C1314 modified in accordance with ACI 530.1 (UBC Standard 21-17) at the rate of three specimens per 5,000 square feet [465 m²] of wall.

3-13.04. Required Masonry Prism Tests. If the design compressive strength of masonry, f'_m , is selected based on preconstruction prism testing, prisms representative of the project masonry will be constructed on site from worksite stockpiles and tested in accordance with ASTM C1314

modified in accordance with ACI 530.1 (UBC Standard 21-17) at the rate of three specimens per 5,000 square feet [465 m²] of wall. The prism testing will be instead of the preceding individual tests for concrete masonry units, grout, and clay masonry units.

End of Section

This page was left blank intentionally

Section 05550

ANCHORAGE IN CONCRETE AND MASONRY

PART 1 - GENERAL

1-1. SCOPE. This section covers the procurement and installation of anchors in concrete and masonry. It includes cast-in-place anchor bolts, adhesive anchors, expansion anchors, undercut anchors, and epoxy grouted anchor bolts and reinforcing bars to be installed in concrete and masonry.

1-2. GENERAL. Unless otherwise specified or indicated on the drawings all anchors and anchor bolts shall be cast-in-place anchor bolts with forged heads or embedded nuts and washers. Unless otherwise indicated bolts in concrete shall have a diameter of at least 3/4 inch [19 mm], and bolts in grouted masonry shall have a diameter of at least 1/2 inch [12.7 mm].

Unless otherwise indicated on the drawings, anchors and anchor bolts used in the following locations and applications shall be of the indicated materials. Other anchors and anchor bolts shall be as indicated on the drawings.

Cast-In-Place and Epoxy Grouted Anchor Bolts.

Submerged locations	Stainless steel.
Locations subject to splashing	Stainless steel.
Buried locations	Stainless steel.
Anchorage of structural steel columns	Stainless steel.
Other exterior locations	Stainless steel.
Other interior locations	Stainless steel.

Adhesive, Expansion, and Undercut Anchors.

Submerged locations	Stainless steel.
Locations subject to splashing	Stainless steel.
Buried locations	Stainless steel.
Anchorage of structural steel columns	Stainless steel.
Other exterior locations	Stainless steel.
Other interior locations	Stainless steel.

Adhesive, expansion, and undercut anchors may be used instead of cast-in-place anchors where specifically indicated or permitted on the drawings or with the specific acceptance by ENGINEER.

1-3. SUBMITTALS. Data and catalog cuts indicating the manufacturer and types of adhesive anchors, expansion anchors, undercut anchors, and epoxy grouts to be supplied shall be submitted in accordance with the submittals section.

1-4. DELIVERY, STORAGE, AND HANDLING. Materials shall be handled, transported, and delivered in a manner which will prevent damage or corrosion. Damaged materials shall be promptly replaced. Materials shall be shipped and stored in original manufacturer's packaging.

PART 2 - PRODUCTS

2-1. MATERIALS. Materials shall be as indicated below.

Anchor Bolts.

Carbon steel	ASTM F1554, Grade 36 with compatible nuts.
Galvanized steel	ASTM F1554, Grade 36 with compatible nuts; hot-dip galvanized, ASTM A153.
Stainless steel	Bolts, ASTM F593, Alloy Group 2; nuts, ASTM F594, Alloy Group 2.
Flat Washers	ANSI B18.22.1; of the same material as anchor bolts and nuts.
Reinforcing Bars	ASTM A615, Grade 60, deformed.
Reinforcing Bars, weldable	ASTM A706, Grade 60, deformed.
Epoxy Grout for Anchor Bolts and Reinforcing Bars.	
Adhesive	
For Floors and Horizontal Surfaces	Sika "Sikadur 35, Hi-Mod LV"; ChemRex "Concrete Liquid LPL"; Sika "Sikadur 32 Hi-Mod".
For Vertical Surfaces and Overhead Applications	Sika "Sikadur 31 Hi-Mod Gel".

Aggregate	As recommended by the epoxy grout manufacturer.
Water	Clean and free from deleterious substances.
Expansion Anchors	Hilti "Kwik-Bolt 3"; ITW Ramset/Red Head "Trubolt Wedge Anchor"; Powers Fasteners "Power-Stud Anchor"; Simpson "Wedge-All".
Undercut Anchors	Hilti "HDA Self Setting Undercut Anchor"; Drillco "Maxi-Bolt".
Adhesive Anchors for Concrete and Grout Filled Masonry.	
Threaded Rods and Nuts	As specified for Anchor Bolts and as recommended by the adhesive manufacturer.
Adhesive	Hilti "HIT HY 150 MAX", "HIT-ICE", "HIT RE 500", or "HVA" Systems; ITW Ramset/Redhead "Red Head Epcon C6" System; Powers Fasteners "Power Fast Epoxy Injection Gel" System; Simpson "SET Epoxy" or "Acrylic-Tie" Systems.
Adhesive Anchors for Hollow Masonry System.	
Threaded Rods and Nuts	As specified for Anchor Bolts and as recommended by the adhesive manufacturer.
Adhesive	Hilti "HIT HY 20" System; ITW Ramset/Redhead "Epcon Ceramic 6" System; Powers Fasteners "Power Fast Epoxy Injection Gel" System; Simpson "SET Epoxy" or "Acrylic-Tie" Systems.
Screen Tubes	As recommended by the manufacturer.

2-2. ANCHORS.

2-2.01. Cast-in-Place Anchor Bolts. Cast-in-place anchor bolts shall be delivered in time to permit setting before the structural concrete is placed. Unless installed in pipe sleeves, anchor bolts shall be provided with sufficient threads to permit a nut to be installed on the concrete side of the concrete form or the supporting template. Two nuts, a jam nut, and a washer shall be

furnished for cast-in-place anchor bolts indicated on the drawings to have locknuts; two nuts and a washer shall be furnished for cast-in-place anchor bolts without locknuts.

2-2.02. Epoxy Grouted Anchor Bolts and Reinforcing. Epoxy grout for installing reinforcing bars and anchor bolts not indicated to be adhesive anchors shall consist of a two-component liquid epoxy adhesive of viscosity appropriate to the location and application, and an inert aggregate filler component, if recommended by the adhesive manufacturer.

Anchor bolts and reinforcing bars shall be free of coatings that would weaken the bond with the epoxy.

2-2.03. Adhesive, Expansion, and Undercut Anchors. When adhesive, expansion, or undercut anchors are indicated on the drawings, only acceptable systems shall be used. Acceptable systems shall include only those systems and products specified or specifically indicated by product name on the drawings. Alternative anchoring systems may be used only when specifically accepted by ENGINEER. An acceptable adhesive anchor system may be used as an alternative in locations where epoxy grouted anchor bolts are specified or indicated.

Unless otherwise required, single nut and washer shall be furnished for adhesive anchors, expansion anchors, and undercut anchors. Adhesive anchors shall be free of coatings that would weaken the bond with the adhesive.

Adhesive anchors in hollow masonry shall utilize screen tubes as recommended by the manufacturer.

PART 3 - EXECUTION

3-1. GENERAL. Anti-seize thread lubricant shall be liberally applied to projecting, threaded portions of stainless steel anchors immediately before tightening of the nuts.

3-2. CAST-IN-PLACE ANCHOR BOLTS. Cast-in-place anchor bolts shall be carefully positioned with templates and secured in the forms prior to placing concrete. CONTRACTOR shall verify that anchorage devices are positioned in accordance with the design drawings and with applicable equipment submittal drawings. Bolts shall be positioned sufficiently in advance of the concrete placement so that an on-site representative of ENGINEER or OWNER will have sufficient time to inspect the bolts prior to placing concrete. If Special Inspection of the anchor bolts is required by the local building code, anchorage shall be placed in sufficient time and with sufficient notification so that such inspection can take place without delaying progress of the work.

Threads, bolts, and nuts spattered with concrete during placement shall be cleaned prior to final installation of the bolts and nuts.

3-3. EPOXY GROUT. Epoxy grout components shall be packaged separately at the factory and shall be mixed immediately before use. Proportioning and mixing of the components shall be done in accordance with the manufacturer's recommendations.

3-3.01. Preparation. Where indicated on the drawings, anchor bolts and reinforcing bars shall be epoxy grouted in holes drilled into hardened concrete. Diameters of holes shall be as follows:

<u>Item</u>	<u>Diameter of Hole</u>
Anchor Bolts and Reinforcing Bars	1/8 inch [3 mm] larger than the outside diameter of the bolt or bar.

The embedment depth for epoxy grouted anchor bolts and reinforcing bars shall be at least 15 bolt or bar diameters, unless otherwise indicated on the drawings.

Holes shall be prepared for grouting as recommended by the epoxy grout manufacturer.

3-3.02. Installation. Anchor bolts and reinforcing bars shall be clean, dry, and free of grease and other foreign matter when installed. The bolts and bars shall be set and the epoxy grout shall be placed in accordance with the recommendations of the grout manufacturer. Care shall be taken to ensure that all spaces and cavities are filled with epoxy grout, without voids.

3-4. ADHESIVE ANCHORS. The embedment depth for adhesive anchors shall be at least 15 rod diameters unless otherwise indicated on the drawings.

Adhesive for adhesive anchors shall be statically mixed in the field during application. All proportioning and mixing of the components shall be in accordance with the manufacturer's recommendations.

Anchors shall be installed in holes drilled into hardened concrete or grout filled masonry. Diameter of holes shall be 1/16 inch [1.5 mm] larger than the outside diameter of the rod unless recommended otherwise by the anchor system manufacturer. Holes shall be prepared for insertion of the anchors by removing all dust and debris using procedures recommended by the adhesive manufacturer.

Adhesive anchors and holes shall be clean, dry, and free of grease and other foreign matter at the time of installation. The adhesive shall be placed and the rods shall be set in accordance with the recommendations of the material manufacturer. Care shall be taken to ensure that all spaces and cavities are filled with adhesive, without voids.

3-5. EXPANSION AND UNDERCUT ANCHORS. Expansion and undercut anchors shall be installed in accordance with the drawings, but in no case shall the embedment depth be less than six bolt diameters. The minimum distance between the center of any anchor and an edge or exterior corner of concrete shall be at least six times the diameter of the bolt. Unless otherwise indicated on the drawings, the minimum distance between the centers of anchors shall be at least 12 times the diameter of the bolt.

End of Section

This page was left blank intentionally

MASONRY WATER REPELLENT COATING

PART 1 - GENERAL

1-1. SCOPE. This section covers the water repellent coating for exterior surfaces of the split face concrete block.

1-2. GENERAL. The water repellent coating shall be delivered in unopened containers, labeled with the manufacturer's name, and shall be applied in accordance with the manufacturer's recommendations.

1-3. SUBMITTALS. Complete specifications covering the materials furnished under this section shall be submitted in accordance with the submittals section. Data verifying that the applicator has been trained and licensed by the manufacturer of the water repellent coating shall also be submitted.

1-4. WARRANTY. The water repellent coating shall have a 5 year written warranty against moisture penetration through the treated areas.

PART 2 - PRODUCTS

2-1. MATERIALS. The water repellent coating shall be "Rainguard XS with Micro-Lok" manufactured by Rainguard Products Company, Inglewood, California.

PART 3 - EXECUTION

3-1. SURFACE PREPARATION. New masonry shall be allowed to cure for 30 days prior to application of the coating, and moisture content on any surface shall not exceed 15 percent as registered on an electronic moisture meter.

The surfaces to which the water repellent coating is to be applied shall be clean and dry. All dirt, grease, asphalt, tar, stains, clinging mortar, efflorescence, and contamination of every kind shall be removed by suitable methods.

All cracks shall be neatly filled and pointed; the pointing mortar shall be allowed to cure and become dry and hard before the water repellent coating is applied. All joints shall be tight and sound.

3-2. APPLICATION. All exterior masonry shall be sealed with water repellent coating applied by experienced, fully trained applicators licensed by the manufacturer of the coating.

The water repellent coating shall be applied in one or two coats, as recommended by the manufacturer, with 48 hours between coats, unless otherwise recommended by the manufacturer. Sufficient coats shall be applied to achieve a consistent and uniform appearance.

The water repellent coating shall be applied with airless spraying equipment using low pressure and tip sizes as recommended. The coating shall be applied as a flood coat as recommended by the manufacturer.

Care shall be taken to shield all surfaces that are not to be covered with the water repellent coating. Any such surfaces which are contaminated shall be immediately and thoroughly cleaned.

End of Section

SINGLE-PLY ROOFING, FULLY ADHERED

PART 1 - GENERAL

1-1. SCOPE. This section covers the furnishing and installing of a fully adhered, single-ply membrane roof system complete with adhesives, fasteners, flashings, insulation, and accessories.

1-2. GENERAL. Except as otherwise indicated on the drawings, all roof decks shall be covered with insulated, fully adhered single-ply membrane roofing system as indicated. The finished roof shall be watertight under all conditions of weather and service except physical damage due to unforeseen causes.

The roof system shall be rated for wind uplift speed to 110 mph peak gusts.

Unless indicated otherwise, a complete total system warranty covering all elements of the roofing system shall be furnished with this work. A warranty which covers only the membrane will not be acceptable.

1-3. SUBMITTALS. Complete specifications and data covering the roofing systems and materials furnished under this section shall be submitted in accordance with the Submittals section.

Drawings shall be submitted showing outline of roof area and roof size, locations and types of roof penetrations, perimeter and penetration details, splice details, special details as needed, and installation instructions.

Drawings shall be submitted showing the insulation manufacturer's recommended layout for each area of tapered insulation and crickets, when such systems are indicated on the drawings.

Samples of the roofing membrane, insulation, and fasteners shall be submitted. Test data for pullout resistance for fastening systems shall be provided.

Data shall be submitted showing compliance with UL requirements for the Class rating and the Factory Mutual wind uplift classification as indicated.

Evidence shall be submitted which shows the roofing system installer to be an authorized applicator of the system furnished.

1-4. SUBCONTRACTOR'S QUALIFICATIONS. Unless indicated otherwise on the drawings, work under this section shall be done by a qualified roofing subcontractor who has been in business for at least 5 years. The roofing subcontractor shall be currently operating under the franchise of the roofing membrane manufacturer. The work shall be inspected by a representative of the membrane manufacturer to verify that materials and methods of application are in accordance with the recommendations of the manufacturer and with these specifications.

1-5. DELIVERY, STORAGE, AND HANDLING. Shipping shall be in accordance with the Shipping section. Handling and storage shall be in accordance with the Handling and Storage section.

Materials shall be delivered in original, unopened containers labeled with the manufacturer's name, brand name, installation instructions, and identification of various items. All materials for the roofing system shall be stored and handled in accordance with the recommendations of the manufacturer.

1-6. WARRANTY. Unless otherwise indicated, the manufacturer of the roofing membrane shall furnish to Owner, through the roofing subcontractor, a nonprorated, no dollar limit, total roof system warranty covering the workmanship and application of the roofing system including membranes, insulation, fasteners, and flashings for a period of 15 years from the date of acceptance.

The warranty shall provide for the repair of the total roofing system including repairs to membrane, flashings, counterflashings, insulation, barrier and cover boards, if required, fasteners, adhesives and sealants resulting from all leaks in the membrane and base flashings that may occur due to defective materials, improper workmanship, and normal weather conditions. Unless otherwise indicated, the warranty shall include general wind uplift speed to 110 mph peak gusts

In addition, the manufacturer shall also provide a separate material warranty covering the membrane for not less than 20 years against premature deterioration because of weathering.

PART 2 - PRODUCTS

2-1. MATERIALS. Unless noted otherwise, all materials used in construction of the roof system shall be furnished by the same manufacturer. Materials shall be manufactured by firms of national reputation.

In order to indicate type, quality, and features required, this specification is based on Carlisle "Sure-Seal" fully adhered system. Equivalent roofing systems manufactured by other manufacturers may also be acceptable provided the requirements of these specifications are met.

Materials shall conform to the following:

Roofing and Flashing Membrane, black	FR-EPDM reinforced compounded elastomer; fire retardant; ASTM D4637; Type I, Class SR, Grade 1, Carlisle "Sure Seal Membrane", 0.060 inch
Formable Flashing Material	Uncured EPDM flashing membrane, 0.060 inch thick. Carlisle "Elastoform Flashing Membrane".

Bonding Adhesive	As recommended by roofing membrane manufacturer.
Splicing Cement	As recommended by roofing membrane manufacturer.
Lap Sealant	As recommended by roofing membrane manufacturer.
In-Seam Sealant	As recommended by roofing membrane manufacturer.
Securement Strips	Membrane manufacturers reinforced universal securement strip; Carlisle "RUSS" system.
Fasteners	Membrane manufacturer's standard.
Water Cutoff Mastic	Membrane manufacturer's standard.
Night Sealant	Membrane manufacturer's standard.
Seam Fastening Plate	Membrane manufacturer's standard.
Molded Pipe Flashing	Membrane manufacturer's standard.
Pourable Sealer	Membrane manufacturer's standard.
Roof Barrier Board	ASTM C1177, 5/8 inch, glass mat gypsum roof board; Georgia Pacific "Dens-Deck Fireguard".
Insulation	
Polyisocyanurate	Polyisocyanurate foam with both sides faced with glass fiber felts; ASTM C1289, Type II; Apache "Pyrox", GAF "Isotherm", Schuller/NRG "E-NRGY-Y 2" or as recommended by the membrane manufacturer.
Tapered	Thickness and slope as indicated on the drawings.
Cricket System	Insulation manufacturer's standard factory pre-cut cricket system, pattern as indicated on the drawings.
Oriented Strand Cover Board	APA performance rated sheathing; OSB Board, Product Standard PRP-108; non-veneer; minimum 7/16 inch thick or as recommended by the membrane manufacturer.
Mechanical Fasteners	

Concrete Deck Applications

Corrosion resistant type as recommended by roofing membrane manufacturer, Factory Mutual approved for roof insulation used, and for fire and wind resistance requirements specified; Carlisle "HP Concrete Spike".

Unless otherwise specified, metal copings, counterflashings, cap flashings and similar metal components are covered in the Sheet Metal section.

PART 3 - EXECUTION

3-1. INSPECTION. The roofing membrane manufacturer's representative and the roofing subcontractor shall conduct all required inspections and shall submit to the roofing manufacturer all required drawings, details, and completed questionnaires for obtaining the specified warranty.

3-2. PREPARATION OF ROOF SURFACES. Roof surfaces shall be cleaned and inspected before any roofing materials are applied. All drainage fixtures shall be set at the proper elevation to permit free flow of water.

The roof surfaces to be covered shall be smooth, hard, dry, and free from high spots, depressions, and frost or effects of frost. Roof surfaces shall be swept clean and free from dust, loosened cement scale, and debris. Roof surfaces shall be examined for openings, holes, or crevices which might allow adhesives or sealants to drip or flow through the deck or between the deck and vertical projections. Such openings shall be filled or covered before any roofing materials are applied.

3-3. APPLICATION OF ROOFING

3-3.01. System. The materials for the roofing systems shall be as specified herein. The roofing system assemblies shall conform to the following systems as indicated on the drawings.

Cast-In Place or Precast Concrete Deck (without vapor retarder)

Flat Structural Deck/Tapered Insulation:

Polyisocyanurate Insulation, tapered.

1 layer of recovery board.

Crickets, where required.

Roof Membrane.

3-3.02. Nailers. Nailers shall be as specified in the Carpentry section. Nailers shall be secured as specified by the roofing membrane manufacturer and as specified by FM Bulletin 1-49. Wood nailers shall be installed at the locations specified herein, as indicated on the drawings, and as recommended by the membrane manufacturer.

3-3.03. Barrier Board. Not used.

3-3.04. Vapor Retarder For Cast-In Place Or Precast Concrete Decks. Not used.

3-3.05. Vapor Retarder For Metal Deck. Not used.

3-3.06. Insulation. Insulation shall be dry when installed. No more insulation shall be installed than can be covered with roofing membrane before the end of the day's work or before the onset of inclement weather.

Unless otherwise specified, insulation shall be laid over the substrate, with joints no wider than 1/4 inch [6 mm]. Joints wider than 1/4 inch [6 mm] shall be filled with the same insulation.

Insulation boards shall be laid with joints staggered between parallel courses and, if required, between layers. Abutting edges of boards shall be laid in moderate contact, not forced into place. At vertical surfaces, insulation shall be cut neatly to provide a clearance of not more than 1/4 inch [6 mm].

Insulation boards for tapered systems shall be positioned in accordance with the manufacturer's layout to produce roof slopes and drainage patterns as indicated on the drawings. The installed thickness of insulation shall be as indicated on the drawings.

Crickets to provide positive roof drainage as indicated on the drawings, shall be installed as indicated on the drawings and per the manufacturer's instructions.

All insulation where recommended over concrete decks by the membrane manufacturer, shall be anchored to the deck with mechanical fasteners in accordance with FM Bulletin 1-28 and the FM Approval Guide. Installation of the mechanical fasteners shall be in accordance with the manufacturer's recommendations.

When high wind uplift is required, anchorage of insulation boards and cover boards shall be provided complete with all necessary anchors, special anchors, and appurtenances to meet the performance and warranty requirements.

3-3.07. Cover Board. Recovery boards shall be installed over all insulation as recommended by the roofing membrane manufacturer. Where high wind designs are indicated and where recommended by the membrane manufacturer, oriented strand board shall be installed over all insulation in lieu of recovery board. Cover boards shall be attached as recommended by the membrane manufacturer for the wind design specified.

3-3.08. Membrane. The roofing membrane shall be positioned over the installed insulation without stretching. Membrane shall be allowed to relax for approximately 1/2 hour prior to bonding.

Sheets of membrane shall be positioned to provide a 3 inch [76 mm] minimum edge lap with adjacent sheets. Adhesive shall be applied to the membrane and the underlying substrate to securely bond the membrane to the board according to the manufacturers recommendations. Membrane shall be rolled to eliminate wrinkles, pockets, or voids. Joints in the membrane shall

be cleaned and permanently joined at the overlap with splicing cement and in-seam sealant as recommended by the membrane manufacturer. Where white on black membrane is required, special care shall be taken to minimize staining and damage to the exposed membrane surfaces by the sealants.

At the end of each day or whenever application of roofing is interrupted, temporary water cutoffs shall be installed at loose edges as recommended by the membrane manufacturer. When work is resumed, the sheet shall be pulled free and trimmed to remove membrane where sealant was previously applied.

3-3.09. Securing Perimeter Membrane. Sheets of membrane shall be secured at the perimeter of each roof level, roof section, curb, skylight, expansion joint, penthouse, and parapet wall, where required, using fastening strips or reinforced universal securement strips mechanically fastened through the membrane and insulation into the wood blocking or structural substrate as recommended by the membrane manufacturer.

3-3.10. Gravel Stops. Not used.

3-3.11. Flashing. Perimeter, wall, roof edge, expansion joints, parapet, and curb flashings, where required, of EPDM membranes shall be provided and installed as recommended by the membrane manufacturer. The splices between the flashing and the membrane roof sheet shall be sealed with lap sealant before flashing is bonded to the vertical surfaces with bonding adhesive. All pipe, conduits, or other roof penetrations shall be flashed with molded pipe flashings and the manufacturer's recommended water cutoff mastic. Formable uncured EPDM flashing membrane shall be limited to inside/outside corners and other unusual projections and shapes.

3-3.12. Roof Drains. Not used.

3-3.13. Walkways. Not used.

3.3.14. Cleanup. Following installation of roofing materials, the roof surface shall be cleaned of all construction materials, traffic grime, accumulated dirt, excess sealants, and other debris. The membrane surface shall be cleaned as recommended by the membrane manufacturer.

End of Section

SHEET METAL

PART 1 - GENERAL

1-1. SCOPE. This section covers sheet metal for flashings and moisture protection. The following sheet metal items are covered in other sections:

Ductwork, louvers, and other sheet metal for the heating, ventilating, and air conditioning system.

1-2. GENERAL. Installation of roof flashings shall be as indicated on the drawings and as specified in the building masonry and roofing sections.

Flashing members to be built into masonry, concrete, or roofing shall be delivered at the proper time for incorporation into the work.

When installing sheet metal items, care shall be taken to avoid marring and improper bending. All components shall be stored in clean, dry storage areas. Contact with corrosive or staining materials shall be prevented. All damaged sections shall be replaced and only undamaged units shall be installed.

1-3. SUBMITTALS. Complete specifications, data, and catalog cuts or drawings covering the items furnished under this section shall be submitted in accordance with the submittals section.

PART 2 - PRODUCTS

2-1. MATERIALS.

Stainless Steel	ASTM A167, Type 302 or 304, AISI 2B finish unless otherwise specified.
Sheet Aluminum	ASTM B209, Allow 3003-H14
Solder	ASTM B32, Alloy Grade 50A (50-50).
Soldering Flux	
For Stainless Steel	Zinc chloride type, Fed Spec 0-F-506, Type II.
For Other Metals	Acid type, Fed Spec O-F-506, Type I, Form A.
Fasteners	Same metal as sheet metal being fastened.

Acrylic Sealant

Pecora "Unicrylic" or Tremco "Mono".

2-2. FLASHINGS. All exposed or contacting flashings shall be of the same material.

2-2.01. Types and Materials.

Miscellaneous Hidden
Flashings

Stainless steel, 26 gage.

Scuppers

Pre-finished .032 in. aluminum,
color and finish to be selected.

Collector Heads

Pre-finished .032 in. aluminum,
color and finish to be selected.

Downspouts

Pre-finished .032 in. aluminum,
color and finish to be selected.

Copings

Pre-finished, pre-manufactured aluminum,
M&M model SLC-800, color and finish to be
selected.

2-3. CONFIGURATIONS.

2-3.01. SCUPPERS AND DOWNSPOUTS. The scupper conductor heads and downspouts shall be of the type indicated on the drawings. Scupper conductor heads shall be installed as indicated on the drawings and shall be coordinated with roofing and flashing installation. All hold-down clips, anchors, and fasteners shall be provided for proper installation. The conductor heads and downspouts shall be finished with a "Kynar 500" fluoropolymer over-baked coating conforming to AAMA 2605.

2-3.02. MISCELLANEOUS METAL FLASHINGS. Metal flashings shall be provided for vents, sleeves, and similar projections through the roof.

PART 3 - EXECUTION

3-1. WATERTIGHT JOINTS. Joints in sheet metal work shall be closed watertight unless slip joints are specifically required. Watertight joints shall be mechanically interlocked and then thoroughly soldered for metals other than aluminum. Joints in aluminum or between aluminum and other metals shall be sealed with acrylic sealant.

All joints shall be wiped clean of flux after soldering. Acid flux shall be neutralized by washing the joints with sodium bicarbonate.

3-2. SCUPPERS AND DOWNSPOUTS. The scupper conductor heads and downspouts shall be as indicated on the drawings and specified herein. Sections of scupper conductor heads shall be formed to the profiles indicated. All joints in conductor heads and downspouts shall be watertight. Downspouts shall have bottom terminations canted outward away from the wall for discharging onto splash blocks or other suitable wear surfacing.

All exposed fasteners shall have exposed portion colored to match the face color of the connected pieces. All fasteners shall be a non-corroding type.

3-3. MISCELLANEOUS METAL FLASHINGS. Metal flashings shall be installed as specified in the roofing section.

3-4. PROTECTION. Adequate protection shall be provided during shipment, site storage, and installation, to prevent damage to materials or finished work.

Aluminum to be placed in contact with concrete, mortar, or dissimilar metals shall be given a heavy coat of coal tar paint.

End of Section

This page was left blank intentionally

CAULKING

PART 1 - GENERAL

1-1. SCOPE. This section covers caulking and sealing.

1-2. GENERAL. The terms "caulking" and "sealing", as used on the drawings and in these specifications, are synonymous. Both terms indicate the materials specified herein. Oil-base caulking shall not be used on this project.

1-3. APPROVALS. All caulking shall meet the requirements of the standards specified herein. All caulking and sealing to be used in contact with potable water shall meet the requirements of ANSI/NSF Standard 61.

1-4. SUBMITTALS. Specifications and data covering the materials proposed for use, together with samples or color cards showing the manufacturer's full line of sealant colors, shall be submitted in accordance with the Submittals section.

PART 2 - PRODUCTS

2-1. MATERIALS.

Thiokol Sealants (polysulfides)	Fed Spec TT-S-00227E, Class A or ASTM 920 Type M; polysulfide rubber, two component.
Nonsag	
Submerged Service, Non potable water	Pecora "Synthacalk GC-2+"; Sonneborn "Sonolastic Polysulfide Sealant".
Nonsubmerged Service	Pecora "Synthacalk GC-2+"; Sonneborn "Sonolastic Polysulfide Sealant"; Polymeric Systems "PSI-350".
Self-Leveling, nonsubmerged	A. C. Horn "Hornflex Traffic Grade"; Polymeric Systems "PSI-350".
Urethane Sealants (Polyurethanes)	Fed Spec TT-S-00227E, Class A, Type 2 and ASTM C920, Type M, Grade NS, two component.
Nonsag	
Submerged Service	

Potable Water	Polymeric Systems "RC-270"; Sika "Sikaflex-2cNS.
Nonpotable Water	Pecora "Dynatred"; Polymeric Systems "RC-270".
Nonsubmerged Service	Bostik "Chem-Calk 500"; Tremco "Vulkem 227"; Pecora "Dynatrol II"; Tremco "DYmeric 240"; Sika "Sikaflex-2cNS".
Self-Leveling, Nonsubmerged Service	Bostik "Chem-Calk 550"; Tremco "Vulkem 245"; Pecora "Urexpan NR-200"; Polymeric Systems "RC-2SL"; Tremco "THC-900".
Acrylic Sealant	Fed Spec TT-S-230; ASTM C834. Bostik "Chem-Calk 600"; Pecora "AC20"; Tremco "Mono 555".
Primer	As recommended by the sealant manufacturer.
Backup Material	Polyethylene or polyurethane foam as recommended by the sealant manufacturer; Dow "Ethafom SB" or Plateau "Denver Foam".
Bondbreaker Tape	Adhesive-backed polyethylene tape as recommended by the sealant manufacturer.

2-2. COLORS. Colors of sealants shall be as selected by Engineer from the manufacturer's standard line of colors. Different colors may be required for different locations.

2-3. LOCATIONS TO BE CAULKED.

2-3.01. With Thiokol or Urethane Sealant (Nonsag) - Submerged Service.

All joints requiring caulking in submerged locations.

2-3.02. With Thiokol or Urethane Sealant (Nonsag) - Nonsubmerged Service.

Entire perimeter of frames for exterior metal doors.

Control joints in masonry walls.

Joints on the underside of prestressed, precast roof members where exposed to view.

Joints between masonry and cast-in-place concrete, where indicated on the drawings.

Other locations where caulking is indicated on the drawings, specified in other sections, or required for weatherproofing.

2-3.03. With Thiokol or Urethane Sealant (Self-Leveling).

Horizontal joints in walks or drives.

Horizontal joints in traffic-bearing decks and slabs.

2-3.04. With Acrylic Sealant.

Watertight joints in sheet metal work.

2-3.05. With Silicone Sealant. Not used.

PART 3 - EXECUTION

3-1. JOINT PREPARATION. All surfaces to receive sealant shall be clean, dry, and free from dust, grease, oil, or wax. Concrete surfaces which have been contaminated by form oil, paint, or other foreign matter which would impair the bond of the sealant to the substrate shall be cleaned by sandblasting. All surfaces shall be wiped with a clean cloth saturated with xylol or other suitable solvent, and shall be primed before the sealant is applied.

Unless otherwise recommended by the sealant manufacturer and permitted by the Engineer, the depth of sealant in a joint shall be equal to the width of the joint, but not more than 1/2 inch. Backup material shall be provided as necessary to control the depth of sealant and shall be of suitable size so that, when compressed 25 to 50 percent, the space will be filled. Backup material shall be rolled or pressed into place in accordance with the manufacturer's installation instructions, avoiding puncturing and lengthwise stretching. If depth of the joint does not permit use of backup material, bondbreaker tape shall be placed at the bottom of the joint to prevent three-sided adhesion.

3-2. SEALING. Sealing work shall be done before any field painting work is started. The air temperature and the temperature of the sealed surfaces shall be above 50°F when sealing work is performed.

Upon completion of the sealing work, each sealed joint shall have a smooth, even, tooled finish, flush with the edges of the sealing recess, and all adjacent surfaces shall be clean. Sealant shall not lap onto adjacent surfaces. Any sealant so applied as to prevent the painting of adjacent surfaces to a clean line, or with an excess of material outside the joint and feathered onto surfaces, shall be removed and the joint resealed.

End of Section

This page was left blank intentionally

Section 08115

FIBERGLASS REINFORCED PLASTIC DOORS AND FRAMES

PART 1 - GENERAL

1-1. SCOPE. This section covers fiberglass reinforced plastic doors and frames. Unless otherwise indicated or specified, all doors shall be flush type. All doors and frames shall be provided by a single manufacturer.

Finish Hardware is covered in the finish hardware section.

1-2. GENERAL. Doors, frames, and appurtenances shall be furnished and installed as specified herein and in accordance with the details and arrangements indicated on the drawings.

Doors shall be constructed using polypropylene honeycomb core, polyurethane core, or end grain balsa wood cores as specified herein.

Subject to the requirements specified herein, FRP doors with polypropylene core shall be equivalent to DOR-TEC Fiberglass door and frame systems, FRP doors with rigid block polyurethane core shall be equivalent to Chem-Pruf Door Co. "Chem-Pruf Door System" and FRP doors with balsa wood core shall be equivalent to FIB-R-DOOR Company "Fiberglass Doors".

1-3. SUBMITTALS. Complete detail drawings of all items specified herein shall be submitted in accordance with the submittals section. Drawings shall show elevations of each door type; details of each frame type; location or identification of each item; typical and special details of construction; methods of assembling sections; location and installation requirements for hardware; size, shape, and thickness of materials; joints; connections; and finish.

PART 2 - PRODUCTS

2-1. MATERIALS. Materials used in the manufacture and installation of FRP doors and frames shall be as follows:

Doors	Fiberglass reinforced plastic face sheets, 0.125 inch minimum thickness, with manufacturer's standard 10 year warranty.
Internal Reinforcing	Manufacturer's standard.

Polypropylene Core	Honeycomb construction with integral scrim bonded to exterior panels.
Urethane Core	1-1/2 inch thick rigid block laminated to exterior panels.
Balsa Wood Core	1-1/2 inch thick rigid end grain balsa wood bonded to exterior panels.
Frame	Solid, all-fiberglass frame with molded-in color conforming to SDI dimensions for profiles shown.
Resin	Premium grade polyester for extreme corrosion resistance, minimum 40 percent fiberglass by weight.
Anchoring Devices	Stainless steel where exposed; zinc plated or galvanized where concealed.
Expansion Anchors	As specified in the anchor bolts and expansion anchors section.

2-1.01. Shop Finish. A color impregnated gel coat finish of 25 mils minimum thickness shall be applied to all door and frame surfaces. The finished surfaces shall be smooth and free from irregularities. Color will be selected from the manufacturer's standard color chart. A minimum of 8 colors shall be available for selection.

2-2. FRAMES. Frames for doors and transoms shall be formed of fiberglass reinforced plastic shapes with molded-in color shall be a minimum 3/16 inch in thickness for the profile indicated on the drawings, with approximately 2 inch face as indicated on the drawings. The frame face shall be sized according to the actual size and width of the opening provided. Resins for frames shall match those used for doors.

2-2.01. Workmanship. The finished work shall be strong and rigid, neat in appearance, and free from defects. Molded members shall be fabricated straight and true, with corner joints well formed, and with fastenings concealed where practicable.

2-2.02. Joints. Joints for frames shall be mitered or butted and continuously sealed on the reverse side to produce rigid joints which are invisible on the face of the frame. Frame bottoms shall be held rigidly in position by spreader bars to maintain proper alignment during shipment and erection.

2-2.03. Hardware Provisions. Frames shall be prepared at the factory for the specified hardware. Frames shall be mortised, reinforced, drilled, and tapped for mortised

hardware, and shall be reinforced for surface- applied hardware. Cover boxes shall be provided in back of all hardware cutouts.

Fiberglass reinforced plastic frames shall have concealed reinforcements for hardware according to manufacturer's standards.

2-2.04. Wall and Floor Anchors. Metal anchors shall be of the sizes and shapes required for the type of adjoining wall construction. Jamb anchors shall be located near the top and bottom of each frame and at intermediate points not to exceed 32 inch spacing.

2-3. DOORS. Doors indicated on the drawings as flush fiberglass reinforced plastic, including doors with glazed openings, shall be as specified herein. Doors shall be prepared to receive the hardware specified in the finish hardware section.

2-3.01. Workmanship. Doors shall be rigid, neat in appearance, and free from defects. Molded members for glazed doors shall be formed straight and true, with joints coped or mitered, well formed, and in true alignment. All joints on exposed surfaces shall be smooth so that they are invisible after finishing.

2-3.02. Sizes and Clearances. Doors shall be 1-3/4 inches thick, full flush type, of the sizes and design indicated. Clearances for doors shall be 1/8 inch at jambs and heads, 1/4 inch at meeting stiles of pairs of doors, and 3/4 inch at bottom unless otherwise indicated or specified.

2-3.03. Construction. Doors shall be constructed with at least 0.125 inch fiberglass reinforced plastic outer sheets. Side edges of doors shall be flush and closed watertight. All seams shall be continuously sealed. Doors shall be prepared at the factory for hardware and for glazing as indicated on the drawings and as specified. Door edges shall be beveled or rounded.

Internally reinforced doors shall have solid polymer reinforcement at all joints and all hardware locations.

Honeycomb polypropylene core, solid polyurethane core, or balsa wood core shall be laminated to the exterior panels. Balsa wood core shall have a minimum density of 8.5 lbs per cubic foot.

Outswinging exterior doors shall be finished flush at the top, with all seams and joints closed watertight as specified for side edges.

2-3.04. Hardware Provisions. Doors shall be mortised, reinforced, drilled, and tapped for mortised hardware. Reinforcing units shall be provided for locksets. Reinforcing plates shall be provided for mortised and surface-applied hardware according to manufacturer's standards.

The location of hardware items shall be in accordance with DHI "Recommended Locations for Builders' Hardware for Standard Steel Doors and Frames".

2-3.05. Glazing Moldings. Not used.

2-3.06. Astragals. The meeting edges of all exterior double doors shall be provided with astragals. Astragals shall be applied to the active leaf.

2-3.07. Transom Panels. The construction of transom panels shall be as specified for FRP doors. Panels shall be set into frames with tape sealant all around for weatherproofing.

PART 3 - EXECUTION

3-1. INSTALLATION. Frames shall be set in position, plumbed, aligned, and braced securely until permanent anchors are set.

Frames set in existing or new walls shall be anchored to walls with non-corroding expansion anchors or as otherwise required by frame manufacturer. Frame placement within the wall construction shall be as indicated on the drawings.

3-1.01. Transom Panels. Transom panels, when provided, shall be fastened to frames with oval-head machine screws or with 1 inch long intermittent welds spaced at 9 inch centers maximum and located on the interior side of the panels.

End of Section

ACCESS HATCHES

PART 1 - GENERAL

1-1. SCOPE. This section covers the fabrication and erection of cast-in-place, off-street, floor access doors and hatches. Roof hatches are specified in the Roof Specialties and Accessories section. Manhole frames and covers are specified in the Sewer Manhole section.

Fabricated items which are indicated on the drawings but not mentioned specifically herein shall be fabricated in accordance with the applicable requirements of this section.

1-2. GENERAL. Equipment furnished under this section shall be fabricated and assembled in full conformity with drawings, specifications, engineering data, instructions, and recommendations of the equipment manufacturer, unless exceptions are noted by Engineer.

Equipment shall be furnished complete with all components and accessories required for proper operation, and any additional materials or construction required by the manufacturer's design.

1-2.01. General Equipment Stipulations. The General Equipment Stipulations shall apply to all equipment furnished under this section. If requirements in this specification differ from those in the General Equipment Stipulations, the requirements specified herein shall take precedence.

1-3. SUBMITTALS.

1-3.01. Drawings and Data. Complete assembly and installation drawings, together with detailed specifications, capacities, weight of each component, complete bill of materials, and accessories forming a part of the equipment furnished, shall be submitted in accordance with the Submittals section.

Verification that access hatches are properly sized to remove the pump equipment as intended by pump manufacturer.

1-4. DELIVERY, STORAGE, AND HANDLING. Shipping shall be in accordance with the Shipping section. Handling and storage shall be in accordance with the Handling and Storage section.

1-5. WARRANTY. The manufacturer shall guarantee against defects in material or workmanship for a warranty period of not less than 5 years.

PART 2 - PRODUCTS

2-1. GENERAL. Work on materials shall be fabricated in conformity with dimensions, arrangements, sizes, and weights or thicknesses specified or indicated on the drawings.

All members and parts shall be free of warps, local deformations, and unauthorized bends. Holes and other provisions for field connections shall be accurately located and shop checked so that proper fit will result when the units are assembled in the field. All field connection materials shall be furnished.

2-2. DESIGN REQUIREMENTS. Access hatches shall be of all-aluminum construction and designed to withstand a live load of 300 psf, with a maximum deflection of 1/150th of the span. Leaves shall pivot so that the cover does not protrude above the channel frame. The door leaves shall be leaf type, constructed of structural shapes and reinforced diamond pattern checkered plate. Structural shapes and plates shall have thickness of not less than ¼ inch. All hardware shall be of stainless steel. The orientation of the access hatches shall be as indicated in the drawings. The hatch opening size shown on the drawings shall be confirmed with the pump equipment manufacturer to ensure the hatch is adequately sized to allow for pump equipment removal. Access hatches shall be as manufactured by Bilco Company, Halliday Products, or US Foundry, without exception.

Door and hatch frames shall be provided with anchorage devices into the concrete slab. Where required for drainage, channel frames shall be 1/4 inch thick with a cross sectional area large enough to allow adequate water drainage. A 1-1/2 inch drainage coupling shall be located in the channel frame. The frame shall be designed to empty through the coupling. Frames shall have a neoprene door cushion unless a specific door model without a cushion is specified. All aluminum surfaces in contact with concrete or mortar shall be given a heavy coat of epoxy enamel unless specified otherwise. Aluminum access doors and hatches shall be given a mill finish.

Hatches shall be supplied with lifting operators and hold-open devices. All doors shall automatically lock in the vertical position by means of a hold-open arm with release handle. A snap lock with a gasketed cover plug and removable turn handle shall be provided. The operators shall provide for smooth, easy and controlled door operation throughout the entire arc of opening and closing. Operation shall not be affected by temperature.

Access hatches shall be etched with the words “Confined Space Empty” when located on wetwells, manholes or other structures where access is confined.

PART 3 - EXECUTION

3-1. INSTALLATION. Materials shall be erected and installed in conformity with the dimensions and arrangements specified or indicated on the drawings and as recommended by the manufacturer. Product finishes damaged during erection shall be repaired as recommended by the manufacturer. Hatch frames with drainage couplings shall be connected to the wetwell.

End of Section

FINISH HARDWARE

PART 1 - GENERAL

1-1. SCOPE. This section covers finish hardware for steel doors, together with cylinders and padlocks which must be keyed to match door locks.

1-2. GENERAL.

1-2.01. Templates. Each hardware manufacturer shall deliver to the door and frame manufacturer a template for each item of mortised and surface-applied hardware. Each template shall be labeled with the manufacturer's name, hardware item, opening number, and location on the door or frame where the item is to be installed.

1-3. SUBMITTALS. A complete schedule of finish hardware shall be submitted in accordance with the submittals section. The schedule shall indicate each item of hardware required for each opening, manufacturer's name, manufacturer's number or symbol, and finish.

1-4. PACKAGING. Each item of hardware shall be packaged separately in an individual container complete with screws, keys, special wrenches, instructions, and installation templates necessary for accurately locating, setting, adjusting, and attaching the hardware. Each container shall be marked with the number of the opening to which the hardware item is to be applied.

PART 2 - PRODUCTS

2-1. ACCEPTABLE MANUFACTURERS. The catalog numbers which appear in the Hardware Schedule identify products of the first-named of the manufacturers listed herein for each hardware item. Equivalent products of the other manufacturers listed herein will also be acceptable.

Butts	Stanley, Hager, or Lawrence.
Locksets, latchsets, cylinders, and padlocks	Von Duprin, Schlage, Yale, or Corbin-Russwin
Exit devices	Von Duprin or Corbin-Russwin.
Closers	LCN or Sargent.
HOLDERS, bumpers, and silencers	Glynn-Johnson or Corbin-Russwin.
Thresholds, cast abrasive	Wooster, American Abrasive, or Stubbs.

Thresholds and drip caps, extruded	Reese, Zero, or Pemko.
Flush bolts	Ives or Quality.
Weatherstripping and automatic door bottoms	Reese, Zero, or Pemko.
Pushbutton combination security lock	Schlage King Cobra (KC5000 series)

2-2. **FINISH.** The required finish shall be as indicated by the catalog number listed in the Hardware Schedule herein. Exterior surfaces of door closers shall be finish painted with shop-applied aluminum paint. Machine screws, bolts, and other exposed attachments shall be finished to match hardware.

2-3. **KEYING.** Cylinder locks and padlocks shall be keyed in groups. After the finish hardware submittals have been accepted by the Engineer, the Engineer and Owner will meet with the Contractor to determine the keying groups.

All locks in each group shall be keyed alike and each group shall be keyed differently. All locks shall be operable by a master key or by master key groups and a grand master key. Two keys shall be furnished with each lock. Six master keys shall be furnished.

PART 3 - EXECUTION

3-1. **INSTALLATION.** Hardware shall be accurately fitted, securely applied, carefully adjusted, and lubricated in accordance with the manufacturer's instructions.

3-1.01. **Location.** Unless otherwise directed by the Engineer, the locations of hardware items shall be in accordance with DHI "Recommended Locations for Builders' Hardware for Standard Steel Doors and Frames".

3-1.02. **Thresholds.** The ends of thresholds shall be notched to fit the applicable door frame profile. Thresholds shall be field drilled to receive flush bolts where required. Thresholds shall be anchored to concrete by means of 5/16 inch diameter stainless steel flat head countersunk machine screws and expansion anchors spaced at 8 inch centers. Thresholds shall be set in asphalt roofing cement conforming to ASTM D4586, Type II.

3-2. **ADJUSTING.** Each supplier of finish hardware shall provide the services of a trained and experienced hardware consultant to service and adjust installed hardware.

3-3. **PROTECTION.** Special care shall be taken to protect finished surfaces of hardware during installation. Hardware on which the finish has been damaged prior to final acceptance of the work shall be replaced with new hardware at no additional cost to the Owner.

3-4. HARDWARE SCHEDULE. Hardware shall be furnished in accordance with the following schedule. Doors are listed by group number. A complete set of hardware is listed for each group.

<u>Group No.</u>	<u>Item</u>	<u>No. Req'd</u>	<u>Catalog No.</u>
1	<i>(Exterior, PR 3'-0"x7'-2", FRP, Locked, Panic Hdwr)</i>		
	Butts	6	FBB191-630 4-1/2"x4-1/2", NRP
	Exit device (Active Leaf) and Pushbutton Security Lock	1 each	9847L-630 Schlage KC5000-06-626
	Dummy Trim (Inactive Leaf)	1	992L-DT-06-630
	Overhead Closer (Active Leaf)	1	4040-H-Cush
	Threshold, Cast Abrasive	1	115 Alumogrit 4"x 1/2"
	Flush Bolts (Inactive Leaf)	2	FB458N-630
	Weatherstripping Head and Jamb Sill	1 set 1	DS70 323
	Astragal	1	874S-S-N
	Drip Cap	1	R199A
	Overhead Stop and Holder, (Inactive Leaf)	1	GJ 90H-630

2 (Exterior, 3'-0"x7'-2", FRP, Locked, Panic Hdwr)

Butts	3	FBB191-630 4-1/2"x4-1/2", NRP
Exit Device and Pushbutton Security Lock	1 each	9875L-630 Schlage KC5000-06-626
Closer	1	4040H-Cush
Threshold	1	115 Alumogrit 4" x 1/2"
Weatherstripping Head and Jamb Sill	1 set 1	DS70 323

End of Section

PROTECTIVE COATINGS

PART 1 - GENERAL

1-1. SCOPE. This section covers field applied protective coatings, including surface preparation, protection of surfaces, inspection, and other appurtenant work for equipment and surfaces designated to be coated with heavy-duty maintenance coatings. Regardless of the number of coats previously applied, at least two field coats in addition to any shop coats or field prime coats shall be applied to all surfaces unless otherwise specified. Refer to Orange County Utilities Standards and Construction Specifications Manual, Appendix D for approved coatings and liners.

1-2. GENERAL. Cleaning, surface preparation, coating application, and thickness shall be as specified herein and shall meet or exceed the coating manufacturer's recommendations. When the manufacturer's minimum recommendations exceed the specified requirements, Contractor shall comply with the manufacturer's minimum recommendations. When equivalent products are acceptable to Engineer, Contractor shall comply with this specification and the coating manufacturer's recommendations.

1-2.01. Governing Standards. All cleaning, surface preparation, coating application, thickness, testing, and coating materials (where available) shall be in accordance with the referenced standards of the following AWWA, ANSI, NACE, SSPC, NSF, and ASTM.

1-2.02. Delivery and Storage. All coating products shall be received and stored in accordance with the coating manufacturer's recommendations.

1-2.03. Coatings, Painting, and Linings Covered in Other Sections. Not used.

1-3. SUBMITTALS. Contractor shall submit color cards for all coatings proposed for use, together with complete descriptive specifications and the completed Coating System Data Sheets, to Engineer for review and color selection. Requests for review submitted directly to Engineer by coating suppliers will not be considered.

When the proposed products will be in contact with treated or raw water in potable water treatment facilities, Contractor shall submit certifications that the proposed systems are in compliance with ANSI/NSF 61.

Contractor shall submit a Coating System Data Sheet for each separately identified surface in the Coating Schedule that will be used in the project, using the appropriate Coating System Data Sheet forms (Figures 1-09940 and 2-09940) at the end of this section. Each field coating system shall be acceptable to the coating material manufacturer. Each Coating System Data Sheet shall include application temperature limits including recoat time requirements for the ambient conditions at the site, including temperatures up to 130°F [54°C]. Temperature requirements shall be specified by the coating manufacturer.

Each proposed coating system shall be assigned a unique number with a prefix letter based on the following:

Prefix	Surfaces	Figure
A	Iron and steel	2
C	Concrete and concrete block	1
E	Equipment - submerged nonsubmerged	1 2
F	Nonferrous metal	1
G	Galvanized	1
H	High temperature	1
P	PVC and FRP	1

Each coating system that will be applied entirely in the field shall be assigned only a prefix letter and no suffix letter. When appropriate under the indicated conditions, the following suffix shall be added to the coating system numbers:

- F Each shop-applied coating system that includes a finish coat applied in the field.

A separate Coating System Data Sheet shall be developed and submitted for each variation or change in a coating system or surface to be coated.

1-4. QUALITY ASSURANCE.

1-4.01. Coating System Data Sheet Certifications. The coating applicator and coating manufacturer shall review and approve in writing the coating manufacturer's written recommendations for the coating system and the intended service. Any variations from the specifications or the coating manufacturers published recommendations shall be submitted in writing and approved by the coating manufacturer. The coating manufacturer shall observe the surface preparation, mixing, and application of the coating systems and submit a written report of his observations and any additional recommendations.

1-4.02. Special Interior Coating Systems. In addition to the requirements for all coating systems, the coating applicator and coating manufacturer shall develop and submit, in writing, the proposed detailed procedures for handling, storing, surface preparation, mixing, and application to verify compliance with this specification and the coating manufacturer's written recommendations. The procedures shall include copies of the coating manufacturer's published recommendations and the proposed method for complying with these recommendations and these specifications. Contractor, coating applicator, and coating manufacturer shall review and approve, in writing, the proposed detail procedures before they are submitted for review.

Contractor and coating manufacturer shall inspect coating application of the appropriate application methods.

PART 2 - PRODUCTS

2-1. ACCEPTABLE MANUFACTURERS.

2-1.01. Equivalent Coatings. Whenever a coating is specified by the name of a proprietary product or of a particular manufacturer or vendor, it shall be understood as establishing the desired type and quality of coating. Other manufacturers' coatings will be accepted, provided that sufficient information is submitted to enable Engineer to determine that the proposed coatings are equivalent to those named. Information on proposed coatings shall be submitted for review in accordance with the Submittals section. Requests for review of equivalency will be accepted only from Contractor, and will be considered only after the contract has been awarded.

2-2. MATERIALS. All coatings shall be delivered to the job in original, unopened containers, with labels intact. Coatings shall be stored indoors and shall be protected against freezing. No adulterant, unauthorized thinner, or other material not included in the coating formulation shall be added to the coating for any purpose.

All coatings shall conform to the air quality regulations applicable at the location of use. Coating materials that cannot be guaranteed by the manufacturer to conform, whether or not specified by product designation, shall not be used.

Contractor shall be responsible for ensuring the compatibility of field coatings with each other or with any previously applied coatings. Coatings used in successive field coats shall be produced by the same manufacturer. The first field coat over shop coated or previously coated surfaces shall cause no wrinkling, lifting, or other damage to underlying coats.

All coatings used on surfaces that will be in contact with potable or treated water shall be certified as being in compliance with ANSI/NSF 61. Coatings that cannot be so certified, whether or not specified by manufacturer and by product designation, shall not be used.

All intermediate and finish coating materials that will be in contact with wastewater atmosphere shall be guaranteed by the manufacturer to be fumeproof and suitable for wastewater plant atmosphere that contains hydrogen sulfide. Coatings that cannot be so guaranteed shall not be used. Lead-free and mercury-free coatings shall be used if available, but in no case shall coatings containing lead or mercury be used that become discolored when exposed to wastewater plant atmosphere.

2-2.01 Primers.

Universal Primer

Ameron "Amercoat 385 Epoxy",
Carboline "Rustbond", ICI Devoe
"Devran 224HS", Tnemec "Series 27
F.C. Typoxy", or Sherwin-Williams
"Macropoxy 646".

Epoxy Concrete Block Filler

Ameron "Amerlock 400BF Epoxy
Block Filler", Carboline "Sanitile 600",
ICI Devoe "Blox Filler 4000", Tnemec

"Series 54-660", or Sherwin-Williams
"Kem Cati-Coat HS".

Epoxy Concrete Filler and
Surfacer

Tnemec "Series 63-1500", Ameron
NuKlad 114A, or Carboline
"Carboguard 510".

2-2.02. Intermediate and Finish Coatings.

Epoxy Enamel (NSF certified
systems)

Ferrous Metal Surfaces and
Concrete Surfaces in Contact
with Treated or Raw Water in
Potable Water Facilities

Ameron "Amerlock 400 High-Solids
Epoxy Coating", Carboline
"Carboguard 891", ICI Devoe "Bar-
Rust 233H" Tnemec "Series N140
Pota-Pox Plus", or Sherwin-Williams
"Macropoxy 646NSF"; immersion
service.

Epoxy Enamel

Concrete Floors

Ameron "Amerlock 400", Carboline
"Carboguard 890", ICI Devoe
"Devran 224HS", Tnemec "Series
N69 Hi-Build Epoxoline II", or
Sherwin-Williams "Armorseal
1000HS"; nonskid.

Ferrous Metal Surfaces and
Masonry or Concrete Surfaces
Other Than Floors

Ameron "Amercoat 385 Epoxy",
Carboline "Carboguard 890", ICI
Devoe Devran "224HS", Tnemec
"Series N69 Hi-Build Epoxoline II",
or Sherwin-Williams "Macropoxy
646".

Aliphatic Polyurethane

Ameron "Amercoat 450H", Carboline
"Carbothane 134HG", ICI Devoe
"Devthane 379H" Tnemec "Series
1074 Endura-Shield II", or Sherwin-
Williams "Acrolon 218HS".

Coal Tar Epoxy

High-build coal tar epoxy; Ameron
"Amercoat 78HB Coal Tar Epoxy",
Carboline "Bitumastic 300 M",
Tnemec "46H-413 Hi-Build
Tneme-Tar", or Sherwin-Williams
"Hi-Mil Sher-Tar Epoxy".

Medium Consistency Coal Tar

Carboline "Bitumastic 50" or Tnemec
"46-465 H.B. Tnemecol".

PART 3 - EXECUTION

3-1. SURFACE PREPARATION. All surfaces to be coated shall be clean and dry and shall meet the recommendations of the coating manufacturer for surface preparation. Freshly coated surfaces shall be protected from dust and other contaminants. Oil and grease shall be completely removed by use of solvents or detergents before mechanical cleaning is started. The gloss on previously coated surfaces shall be dulled if necessary for proper adhesion of topcoats.

Surfaces shall be free of cracks, pits, projections, or other imperfections that would interfere with the formation of a smooth, unbroken coating film, except for concrete block construction where a rough surface is an inherent characteristic.

When applying touchup coating or repairing previously coated surfaces, the surfaces to be coated shall be cleaned as recommended by the coating manufacturer, and the edges of the repaired area shall be feathered by sanding or wire brushing to produce a smooth transition that will not be noticeable after the coating is applied. All coatings made brittle or otherwise damaged by heat of welding shall be completely removed.

3-1.01. Galvanized Surfaces. Galvanized surfaces shall be prepared for coating according to the instructions of the manufacturer of the epoxy enamel. Any chemical treatment of galvanized surfaces shall be followed by thorough rinsing with clean water.

3-1.02. Ferrous Metal Surfaces. Ungalvanized ferrous metal surfaces shall be prepared for coating by using one or more of the following cleaning procedures as specified: solvents (SSPC-SP1); blasting (SSPC-SP5, -SP6, -SP7, or -SP10); power tools (SSPC-SP3 or -SP11); or hand tools (SSPC-SP2). Oil and grease shall be completely removed in accordance with SSPC-SP1 before beginning any other cleaning method. Surfaces of welds shall be scraped and ground as necessary to remove all slag and weld spatter. Tools which produce excessive roughness shall not be used.

All components of equipment that can be properly prepared and coated after installation shall be installed prior to surface preparation. Components that will be inaccessible after installation shall have the surfaces prepared and coated before installation. Motors, drive trains, and bearings shall be protected during surface preparation in accordance with the equipment manufacturer's recommendations.

All cut or sheared edges shall be ground smooth to a 1/8 inch minimum radius for all material 1/4 inch thickness and larger. For material thickness less than 1/4 inch all cut or sheared edges shall be ground smooth to a radius equal to 1/2 the material thickness. Grinding of rolled edges on standard shapes with a minimum radius of the 1/16 inch will not be required.

All ferrous metal surfaces shall have all welds ground smooth and free of all defects in accordance with NACE Standard RPO178, Appendix C, Designation C and sharp edges ground smooth, if not previously prepared in the shop. Instead of blending of the weld with the base metal as required by the NACE standard, it will be acceptable to furnish a welded joint that has a smooth transition of the weld to the base metal. All welds shall be ground smooth to ensure satisfactory adhesion of paint.

The cleaning methods and surface profiles specified herein are minimums, and if the requirements printed in the coating manufacturer's data sheets exceed the limits specified, the value printed on the data sheets shall become the minimum requirement.

3-1.02.01. Ferrous Metal Surfaces – Non-immersion Service. Ferrous metal surfaces, including fabricated equipment, in non-immersion service shall be cleaned to the degree recommended by the coating manufacturer for surfaces to be coated with coal tar epoxy, epoxy enamel, and heat-resistant coatings, except galvanized surfaces. Blast cleaning to at least SSPC-SP6 shall be used where recommended by the coating manufacturer, and may be used elsewhere at the option of Contractor, provided that no dust is permitted to settle on adjacent wet coating. Surface profile shall be as recommended by coating manufacturer, but not less than 2 mils [50 µm].

3-1.02.02. Ferrous Metal Surfaces - Immersion Service. Surface preparation of ferrous metal surfaces in immersion service shall consist of blast cleaning to at least SSPC-SP10 and the first application of coating shall be performed on the same day. If more surface area is prepared than can be coated in one day, the uncoated area shall be blast cleaned again to the satisfaction of Engineer. Surface profile shall be as recommended by coating manufacturer, but not less than 3.5 mils [88 µm]. Immersion service includes any material in wetwells or valve vaults, regardless of whether material is below water level.

3-1.03. Concrete Surfaces. All concrete surfaces shall be free of objectionable substances and shall meet the coating manufacturer's recommendations for surface preparation. Any other surface preparation recommended by the coating material manufacturer shall be brought to Engineer's attention and may be incorporated into the work if acceptable to Engineer.

All concrete surfaces shall be dry when coated and free from dirt, dust, sand, mud, oil, grease, and other objectionable substances. Oil and grease shall be completely removed by use of solvents or detergents before mechanical cleaning is started.

New concrete shall have cured for at least 4 weeks before coating is applied as recommended by the material manufacturer. Concrete surfaces shall be tested for capillary moisture in accordance with ASTM D4263. There shall be no capillary moisture when coatings are applied on concrete.

All surfaces to be coated shall be cleaned in accordance with ASTM D4258 and abraded in accordance with ASTM D4259. Surface profile shall be at least 25 percent of the dry film thickness specified for the coating system. Prior to application of the coating, the surfaces shall be thoroughly washed or cleaned by air blasting to remove all dust and residue. Spalled areas, voids, and cracks shall be repaired in accordance with the Concrete section and as acceptable to the Engineer. Fins and other surface projections shall be removed to provide a flush surface before application of coating.

Except where epoxy enamel is applied as damp-proofing, the concrete surfaces, including those with bug holes less than 1 inch [25 mm] in any dimension, shall be prepared when required and as recommended by the manufacturer, using an epoxy concrete filler and surfacer. Where coating with a vinyl ester the concrete filler and surfacer shall be as recommended by the manufacturer to be compatible with vinyl ester.

3-1.04. Concrete Block Surfaces. Voids and openings in concrete block surfaces shall be pointed. All exposed exterior surfaces and surfaces to be coated with epoxy enamel, including the joints, shall be filled so that a continuous unbroken coating film is obtained.

3-1.05. Copper Tubing. All flux residue shall be removed from joints in copper tubing. Immediately before coating is started, tubing shall be wiped with a clean rag soaked in xylol.

3-1.06. Plastic Surfaces. All wax and oil shall be removed from plastic surfaces that are to be coated, including PVC and FRP, by wiping with a solvent compatible with the specified coating.

3-1.07. Hardware. Hardware items such as bolts, screws, washers, springs, and grease fittings need not be cleaned prior to coating if there is no evidence of dirt, corrosion, or foreign material.

3-1.08. Aluminum. When a coating system is required, remove all oil or deleterious substance with neutral detergent or emulsion cleaner or blast lightly with fine abrasive.

3-1.09. Stainless Steel. When a coating system is required, surface preparation shall conform to the coating manufacturer's recommendations.

3-2. MIXING AND THINNING. Coating shall be thoroughly mixed each time any is withdrawn from the container. Coating containers shall be kept tightly closed except while coating is being withdrawn.

Coating shall be factory mixed to proper consistency and viscosity for hot weather application without thinning. Thinning will be permitted only as necessary to obtain recommended coverage at lower application temperatures. In no case shall the wet film thickness of applied coating be reduced, by addition of coating thinner or otherwise, below the thickness recommended by the coating manufacturer. Thinning shall be done in compliance with all applicable air quality regulations.

3-3. APPLICATION. Coating shall be applied in a neat manner that will produce an even film of uniform and proper thickness, with finished surfaces free of runs, sags, ridges, laps, and brush marks. Each coat shall be thoroughly dry and hard before the next coat is applied. In no case shall coating be applied at a rate of coverage greater than the maximum rate recommended by the coating manufacturer.

Coating failures will not be accepted and shall be entirely removed down to the substrate and the surface recoated. Failures include but are not limited to sags, checking, cracking, teardrops, fat edges, fisheyes, or delamination.

3-3.01. Priming. Edges, corners, crevices, welds, and bolts shall be given a brush coat (stripe coat) of primer before application of the primer coat. The stripe coat shall be applied by a brush and worked in both directions. Special attention shall be given to filling all crevices with coating.

Abraded and otherwise damaged portions of shop-applied coating shall be cleaned and recoated as recommended by the manufacturer of the finish coating. Welded seams and other uncoated surfaces, heads and nuts of field-installed bolts, and surfaces where coating has been damaged by

heat shall be given a brush coat of the specified primer. Before the specified spot or touchup coating of metal surfaces, edges, corners, crevices, welds, and bolts in the area of the spot or touchup coating shall be given a brush coat of primer. This patch, spot, or touchup coating shall be completed, and the paint film shall be dry and hard, before additional coating is applied.

3-3.02. Epoxy Enamel. When used, epoxy enamel shall be applied in accordance with the coating manufacturer's recommendations, including temperature limitations and protection from sunlight until top-coated.

When concrete is to be coated, coatings shall not be applied to concrete surfaces in direct sunlight or when the temperature of the concrete is rising. Preferably the coating shall be applied when the temperature of the concrete is dropping.

When applying high build epoxy coatings with a roller or brush and where a dry film thickness of at least 4-6 mils [100-150 µm] per coat is required, two or more coats shall be applied to achieve the recommended dry film thickness equal to a spray applied coating.

3-3.03. Coal Tar Epoxy. When used, the application of coal tar epoxy, including time limits for recoating, shall conform to the recommendations of the coating manufacturer.

When concrete is to be coated, coatings shall not be applied to concrete surfaces in direct sunlight or when the temperature of the concrete is rising. Preferably the coating shall be applied when the temperature of the concrete is dropping.

3-3.04. Film Thickness. The total coating film thickness including intermediate coats and finish coat, shall be not less than the following:

<u>Type of Coating</u>	<u>Minimum Dry Film Thickness</u>
Medium consistency coal tar	20 mils [500 µm].
Coal tar epoxy (two coats)	20 mils [500 µm].
Epoxy enamel	
Floors	5 mils [125 µm].
Surfaces with first coat of epoxy enamel and final coat of aliphatic polyurethane	7 mils [175 µm] (5 mils [125 µm] DFT for epoxy plus 2 mils [50 µm] DFT for aliphatic polyurethane).
Surfaces with first and second coat of epoxy enamel and final coat of aliphatic polyurethane	12 mils [300 µm] (10 mils [250 µm] DFT for epoxy plus 2 mils [50 µm] DFT for aliphatic polyurethane).
Other surfaces (two coats)	10 mils [250 µm].
Immersion service (three coats)	15 mils [375 µm].
Other surfaces (one coat)	5 mils [125 µm].
Other surfaces (two coats)	10 mils [250 µm].

3-3.05. Weather Conditions. Coatings shall not be applied, except under shelter, during wet, damp, or foggy weather, or when windblown dust, dirt, debris, or insects will collect on freshly applied coating.

Coatings shall not be applied at temperatures lower than the minimum temperature recommended by the coating manufacturer, or to metal surfaces such as tanks or pipe containing cold water, regardless of the air temperature, when metal conditions are likely to cause condensation. When necessary for proper application, a temporary enclosure shall be erected and kept heated until the coating has fully cured.

Coatings shall not be applied at temperatures higher than the maximum temperature recommended by the coating manufacturer. Where coatings are applied during periods of elevated ambient temperatures, Contractor and the coatings manufacturer shall be jointly responsible to ensure that proper application is performed including adherence to all re-coat window requirements. Precautions shall be taken to reduce the temperature of the surface application, especially for metal, at elevated temperatures above 100°F [38°C] including shading application area from direct sunlight, applying coating in the evening or at night, and ventilating the area to reduce the humidity and temperature.

3-4. REPAIRING FACTORY FINISHED SURFACES. Factory finished surfaces damaged prior to acceptance by Owner shall be spot primed and recoated with materials equivalent to the original coatings. If, in the opinion of Engineer, spot repair of the damaged area is not satisfactory, the entire surface or item shall be recoated.

3-5. PROTECTION OF SURFACES. Throughout the work Contractor shall use drop cloths, masking tape, and other suitable measures to protect adjacent surfaces. Contractor shall be responsible for correcting and repairing any damage resulting from its or its subcontractors' operations. Coatings spilled or spattered on adjacent surfaces which are not being coated at the time shall be immediately removed. Exposed concrete or masonry not specified to be coated which is damaged by coatings shall be either removed and rebuilt or, where authorized by Owner, coated with two coats of masonry coating.

3-6. FIELD QUALITY CONTROL. The following inspection and testing shall be performed: surface profile, visual inspection, and wet and dry film thickness testing. All inspection and testing shall be witnessed by Engineer.

3-6.01. Surface Profile Testing. The surface profile for ferrous metal surfaces shall be measured for compliance with the specified minimum profile. The surface profile for concrete shall comply with SSPC 13/NACE 6 Table 1 for severe service.

3-6.02. Visual Inspection. The surface of the protective coatings shall be visually inspected.

3.6.03. Film Thickness. Coating film thickness shall be verified by measuring the film thickness of each coat as it is applied and the dry film thickness of the entire system. Wet film thickness shall be measured with a gauge that will measure the wet film thickness within an accuracy of ± 0.5 mil [12.5 μm]. Dry film thickness shall be measured in accordance with SSPC-PA 2.

3-6.04. Spark Testing. Not required.

3-6.05. Adhesion Testing. Not required.

3-7. FIELD PRIMING SCHEDULE. In general, steel and cast iron surfaces of equipment are specified to be shop primed. Any such surfaces which have not been shop primed shall be field primed. Damaged or failed shop coatings which have been determined unsuitable by Engineer shall be removed and the surfaces shall be field coated, including prime coat (if any). Galvanized, aluminum, stainless steel, and insulated surfaces shall be field primed. Primers used for field priming, unless otherwise required for repair of shop primers, shall be:

<u>Surface To Be Primed</u>	<u>Material</u>
Equipment, surfaces to be coated with	
Aliphatic polyurethane	Universal primer.
Epoxy enamel	Same as finish coats.
Coal tar coating	Same as finish coats.
Steel and cast iron, surfaces to be coated with	
Epoxy enamel	Same as finish coats.
Coal tar coating	Same as finish coats.
Aluminum	Epoxy enamel.
Galvanized	Epoxy enamel.
Copper	Epoxy enamel.
Stainless steel	Epoxy enamel.
Plastic surfaces, including PVC and FRP	Same as finish coats.
Insulated piping	As recommended by manufacturer of finish coats.
Concrete, surfaces to be coated with epoxy enamel	
For damp-proofing	Epoxy enamel.
For all other surfaces	Epoxy concrete filler and surfacer.
Concrete block exposed in exterior locations	Epoxy concrete block filler.
Concrete block to be coated with epoxy enamel	Epoxy concrete block filler.

Unless otherwise recommended by the coating manufacturer or specified herein, priming will not be required on concrete, or concrete block, nor on metal surfaces specified to be coated with epoxy enamel, coal tar epoxy, and heat-resistant coatings. Concrete surfaces to be coated with epoxy enamel shall be filled with epoxy concrete filler and surfacer so that a continuous film is obtained, except where concrete is damp-proofed with epoxy enamel.

3-8. FINISH COATING SYSTEMS. The following schedule lists coatings systems and coating system designations.

No.	Finish Coating Systems	Coating System Designation						
		A	C	E	F	G	H	P
1.	Epoxy enamel – One coat	x			x	x		
2.	Epoxy enamel – Two coats	x	x	x	x	x		x
3.	Epoxy enamel / NSF – Two coats		x	x				
4.	Epoxy enamel – Three coats	x	x	x				
5.	Epoxy enamel / NSF – Three coats		x	x				
6.	Epoxy enamel – First coat Aliphatic polyurethane – Finish coat	x	x	x	x	x		x
7.	Epoxy enamel – First and second coat Aliphatic polyurethane – Finish coat			x	x	x		
8.	Universal primer – First coat Aliphatic polyurethane – Finish coat	x		x				
9.	Medium consistency coal tar – Two coats	x	x	x				
10.	Coal tar epoxy – Two coats	x	x	x				
11.	Vinyl ester – Two coats			x				
12.	Heat resistant – Two coats						x	
13.	High heat resistant – Two coats						x	

3-8.01. Surfaces Not To Be Coated. Unless otherwise specified, the following surfaces shall be left uncoated:

Exposed aluminum, except ductwork.

Polished or finished stainless steel. Unfinished stainless steel, except flashings and counter flashings, shall be coated.

Nickel or chromium.

Galvanized surfaces, except piping, conduit, ductwork, and other items specifically noted.

Rubber and plastics, except as specified.

Exterior concrete.

Surfaces specified to be factory finished.

3-8.02. Field Coating. Items to be field coated include the following. Field coating shall be in accordance with the field priming schedule, the coating schedule, and the manufacturer's recommendations.

a. Surfaces not indicated to be shop finished and surfaces where blast cleaning can be performed in the field.

b. All interior ferrous metal surfaces.

c. Other items as otherwise specified.

3-9. METAL SURFACES COATING SCHEDULE.

<u>Surface To Be Coated</u>	<u>Finish Coating System</u>
Non-galvanized and galvanized structural and miscellaneous steel exposed to view or to the elements in exterior locations.	A6, A7
Non-galvanized and galvanized structural and miscellaneous steel exposed to view inside buildings.	A2
Steel handrails, steel floor plates, doors, door frames.	A8
Unless otherwise specified, pumps, motors, speed reducers, and other machines and equipment exposed to view.	E8
Actuator surfaces for sluice gates, slide gates, control weirs, unless factory finished.	E7, E6
Metal curbs for skylights and power roof ventilators.	A1
Heating and air conditioning units, convector covers, electrical equipment cabinets, and similar Items and equipment (unless factory finished) exposed to view.	E8
Surfaces of cranes and hoists exposed to view indoors.	E2
Surfaces of cranes and hoists exposed to the elements outdoors.	E6, E7
Steel yard lighting poles exposed to view or to the elements.	A8
Cast Iron and steel piping inside buildings, including valves, fittings, flanges, bolts, supports, and accessories, and galvanized surfaces after proper priming.	A2
Cast Iron and steel piping above grade exposed to the elements and to view outdoors, including valves, fittings, flanges, bolts, supports, and accessories, and galvanized surfaces after proper priming.	A6, A7
Copper pipe and tubing, including fittings and valves.	F1, F2

<u>Surface To Be Coated</u>	<u>Finish Coating System</u>
Copper pipe and tubing, including fittings and valves exposed to view in exterior locations.	F6, F7
All metal surfaces, unless otherwise specified, which will be submerged or buried, all or in part, including valves, and scum baffles, and sluice gates, but excluding piping laid in the ground.	E4 or A10E5
Miscellaneous castings, including manhole rings and covers, and manhole steps. (One coat, if not shop coated.)	E2 or A10E3
Cast iron and steel piping in manholes, wetwells, and similar locations, including valves fittings, flanges, bolts, supports, and accessories.	A4 or A10E5
All metal harness anchorage for buried piping.	A10
All iron and steel parts that will be fully or partially submerged, exposed to sewage gas, or concealed inside; and digester mixing equipment.	E10, E11
Supports and miscellaneous metal for equipment handling corrosive chemicals.	Outdoor - A6 Outdoor - A7 Indoor - A2
Aluminum in contact with concrete.	F1
Engine exhaust piping.	H12
Aluminum and galvanized ductwork and conduit indoors.	F1 or G1 F2 or G2
Aluminum and galvanized ductwork and conduit exposed to elements outdoors.	F6 or G6 F7 or G7
Aluminum materials exposed to the elements outdoors.	F6, F7

3-10. CONCRETE AND MASONRY SURFACES COATING SCHEDULE.

<u>Surface To Be Coated</u>	<u>Finish Coating System</u>
All concrete and concrete block (Except floors and surfaces scheduled to receive other coatings) which are exposed to view.	Indoor –C2 Outdoor –C7
Where indicated on the drawings, walls, floors, and curbed areas, adjacent to corrosive chemical storage and feed equipment.	C2

Interior walls of filter boxes, full height above underdrains and including edges of walkways. C5

3-11. MISCELLANEOUS SURFACES COATING SCHEDULE.

Plastic Surfaces, including PVC and FRP.	Outdoor - P6 Indoor - P2
Piping Insulation	Outdoor - P6 Indoor - P2

3-12. PIPING IDENTIFICATION SCHEDULE. Exposed piping and piping in accessible chases shall be identified with lettering or tags designating the service of each piping system, marked with flow directional arrows, and color coded.

Piping scheduled to be color coded shall be completely coated with the indicated colors, except surfaces specified to remain uncoated shall include sufficiently long segments of the specified color to accommodate the lettering and arrows. All other piping shall be coated to match adjacent surfaces, unless otherwise directed by Engineer.

3-12.01. Location. Lettering and flow direction arrows shall be provided on pipe near the equipment served, adjacent to valves, on both sides of wall and floor penetrations, at each branch or tee, and at least every 50 feet [15 m] in straight runs of pipe. If, in the opinion of Engineer, this requirement will result in an excessive number of labels or arrows, the number required shall be reduced as directed.

3-12.02. Metal Tags. Where the outside diameter of pipe or pipe covering is 5/8 inch [15 mm] or smaller, aluminum or stainless steel tags shall be provided instead of lettering. Tags shall be stamped as specified and shall be fastened to the pipe with suitable chains. Pipe identified with tags shall be color coded as specified.

3-12.03. Lettering. Lettering shall be painted or stenciled on piping or shall be applied as snap-on markers. Snap-on markers shall be plastic sleeves, Brady "Bradysnap-On B-915" or Seton "Setmark". Letter size shall be as follows:

<u>Outside Diameter of Pipe or Covering</u>	<u>Minimum Height of Letters</u>
5/8 inch and smaller	Metal tags -1/4 inch
3/4 to 4 inches	3/4 inch
5 inches and larger	2 inches

3-12.04. Color Coding and Lettering. All piping for the following services shall be color coded. Bands shall be 6 inches [150 mm] wide spaced along the pipe at 5 foot [1.5 m] intervals. For services not listed, the color coding and lettering shall be as directed by the Engineer.

Piping Identification		
Service	Color of Pipe	Color of Letters
Fuel Oil	Black	White
Nonpotable or Raw Water	Light blue with white bands	Black
Odor Control	Dark green with light brown bands	White
Oil - Hydraulic	Black with white bands	White
Plumbing Vents	Dark gray	White
Potable Water (hot or cold)	Light blue	Black
Sewage	Light gray	Black

Electrical conduit shall be coated to match adjacent ceiling or wall surfaces as directed by Engineer. Vent lines shall be coated to match surfaces they adjoin.

In addition, special coating of the following items will be required:

<u>Item</u>	<u>Color</u>
Valve handwheels and levers	Red
Hoist hooks and blocks	Yellow and black stripes

Numerals at least 2 inches [50 mm] high shall be painted on or adjacent to all accessible valves, pumps, flowmeters, and other items of equipment which are identified on the drawings or in the specifications by number.

End of Section

THIS PAGE LEFT BLANK INTENTIONALLY

SURFACE DESCRIPTION	SYSTEM NO. -

SURFACE PREPARATION DESCRIPTION
<input type="checkbox"/> Solvent SSPC-SP1 <input type="checkbox"/> Ferrous Metal Nonimmersion SSPC-SP6 <input type="checkbox"/> Ferrous Metal Immersion <ul style="list-style-type: none"> <input type="checkbox"/> SSPC-SP10 <input type="checkbox"/> SSPC-SP-5 <input type="checkbox"/> Other

COATING	DFT mils [μm]	MANUFACTURER AND PRODUCT
First Coat (Primer)		
Second Coat		
Third Coat		
Total System		Not less than minimum thickness specified.

Notes: (Attached if needed.)

Project:		
Coatings Manufacturer:		Initials _____
Painting Applicator:		Initials _____
BLACK & VEATCH	COATING SYSTEM DATA SHEET	Fig 1-09940

THIS PAGE LEFT BLANK INTENTIONALLY

SURFACE DESCRIPTION	SYSTEM NO. -	-F

SURFACE PREPARATION DESCRIPTION
<input type="checkbox"/> Solvent SSPC-SP1 <input type="checkbox"/> Other:

COATING	DFT mils [µm]	MANUFACTURER AND PRODUCT
Shop (Primer)		(Identify Product/Type)
Touchup		
Intermediate Coat		
Finish Coat		
Total System		Not less than minimum thickness specified.

Notes: (Attached if needed.)

Project:		
Coatings Manufacturer:		Initials _____
Painting Applicator:		Initials _____
BLACK & VEATCH	COATING SYSTEM DATA SHEET	Fig 2-09940

THIS PAGE LEFT BLANK INTENTIONALLY

MISCELLANEOUS SPECIALTIES

PART 1 - GENERAL

1-1. SCOPE. This section covers the miscellaneous items of work not covered in other sections.

1-2. GENERAL. Miscellaneous specialties shall be furnished and installed as specified herein and in accordance with the details, arrangements, and dimensions indicated on the drawings. Where not specifically indicated or specified, fasteners, gaskets, and other accessories shall be provided as required and as recommended by the manufacturer of the specific item.

1-3. SUBMITTALS. Complete specifications, detailed drawings, and setting or erection drawings covering miscellaneous specialties shall be submitted in accordance with the submittals section.

PART 2 - PRODUCTS

2-1. PRODUCTS.

2-1.01. Fire Extinguishers. Portable fire extinguishers of the all-purpose, nitrogen-pressured, dry chemical type shall be provided as scheduled herein. The fire extinguishers shall be UL-approved for Class A, B, and C fires and shall have a 10 pound capacity, such as Badger "10ABC", Buckeye "10H-ABC", or Kidde "10TAS". Finish of shell shall be red with all metal handle and valve.

Wall-mounted fire extinguishers shall be mounted on suitable wall brackets at the locations indicated below.

The following fire extinguishers shall be provided:

<u>Location</u>	<u>Quantity</u>	<u>Mounting</u>
Rm 101 near D101	1	Surface

2-1.02. Splash Blocks. Precast reinforced concrete splash blocks shall be provided at the locations indicated on the drawings. The blocks shall be approximately 16 inches wide by 30 inches long by 5 inches high, with curbs on three sides. The splash portion shall be sloped from not less than 1 inch depth at the inlet end to not less than 2 inches at the outlet end. The block shall be reinforced with not less than WWF4X4-W4XW4 welded wire fabric.

PART 3 - EXECUTION

3-1. INSTALLATION. All products herein shall be installed as recommended by the manufacturer and as indicated on the drawings. All moving parts shall be properly lubricated and adjusted as required for proper operation.

End of Section

Section 11060

EQUIPMENT INSTALLATION

PART 1 - GENERAL

1-1. SCOPE. This section covers installation of new equipment units that have been purchased by Contractor as part of this Work.

Startup requirements shall be as indicated in the Startup Requirements section.

1-2. GENERAL. Equipment installed under this section shall be erected and placed in proper operating condition in full conformity with drawings, specifications, engineering data, instructions, and recommendations of the equipment manufacturer, unless exceptions are noted by Engineer.

When pumping units are being installed, hydraulic considerations and definition of terms shall be as set forth in the Hydraulic Institute Standards.

Any equipment identified as being provided by others will be furnished complete for installation by Contractor. Technical specifications under which the equipment will be purchased are available.

Any existing equipment which is removed shall be handled as indicated in the Project Requirements section.

1-2.01. Coordination. When manufacturer's field services are provided by the equipment manufacturer, Contractor shall coordinate the services with the equipment manufacturer. Contractor shall give Engineer written notice at least 30 days prior to the need for manufacturer's field services furnished by others.

Submittals for equipment furnished by others under each procurement contract will be furnished to Contractor upon completion of review by Engineer. Contractor shall review equipment submittals and coordinate with the requirements of the Work and the Contract Documents. Contractor accepts sole responsibility for determining and verifying all quantities, dimensions, and field construction criteria.

Flanged connections to equipment including the bolts, nuts, and gaskets are covered in the appropriate pipe specification section.

1-3. DELIVERY, STORAGE, AND HANDLING.

1-3.01. Storage. Upon delivery, all equipment and materials shall immediately be stored and protected by Contractor in accordance with the Handling and Storage section until installed in the Work. Equipment shall be protected by Contractor against damage and exposure from the elements. At no time shall the equipment be stored on or come into contact with the ground, grass, or any other type of vegetation. Contractor shall keep the equipment dry at all times.

PART 2 - PRODUCTS

2-1. MATERIALS. Materials shall be as follows:

Grout As specified in the Grout section.

PART 3 – EXECUTION

3-1. INSTALLATION.

3-1.01. General. The following items shall be installed by the Contractor:

Submersible pumps
Engine-generators
Odor Control System

Equipment shall not be installed or operated except by, or with the guidance of, qualified personnel having the knowledge and experience necessary to obtain proper results as specified in the Startup Requirements section.

Each equipment unit shall be leveled, aligned, and shimmed into position. Installation procedures shall be as recommended by the equipment manufacturer and as required herein. Shimming between machined surfaces will not be permitted.

Unless otherwise indicated or specified, all equipment shall be installed on concrete bases at least 6 inches [150 mm] high. Baseplates shall be anchored to the concrete base with required anchor bolts. For equipment with grouted bases, the space beneath shall be filled with grout as specified in the Equipment Grout section. The equipment base shall be grouted after initial fitting and alignment.

Anti-seize thread lubricant shall be liberally applied to the threaded portion of all stainless steel bolts during assembly.

When specified in the equipment sections, the equipment manufacturer will provide installation supervision and installation checks. For installation supervision, the manufacturer's field representative will observe, instruct, guide, and direct Contractor's erection or installation procedures as specified in the equipment specifications. For installation checks, the

manufacturer's field representative will inspect the equipment installation immediately following erection by Contractor, and observe the tests indicated in Startup Requirements section. The manufacturer's representatives will revisit the site as often as necessary to ensure installation satisfactory to Owner.

3-1.02. Pumping Units. When pumping units are to be installed, the equipment shall be installed in accordance with the Hydraulic Institute Standards. When installing pumping units, the equipment base shall be grouted after initial fitting and alignment, but before final bolting of connecting piping. Special care shall be taken to maintain alignment of pumping unit components. No stresses shall be transmitted to the pump flanges. After final alignment and bolting, connections to pumping equipment shall be tested for applied piping stresses by loosening the flange bolts. If any movement or opening of the joints is observed, piping shall be adjusted to proper fit.

Couplings shall be realigned after grouting. Final coupling misalignment shall be within one-half of the coupling manufacturer's allowable tolerance.

3-1.02.01. Vertical End Suction Centrifugal Pumps. Not used.

3-1.02.02. Submersible Pumps. Control cables shall be supported to avoid tension and damage. Mounting of cable supports in wetwells will be coordinated by the pump supplier. Liquid level sensors shall operate freely and shall be adjusted to the levels indicated in the respective pump schedules, or in the electrical schematics or P&ID's. Each system of sensors will be furnished by others, and shall be installed complete with all required mounting brackets, weights, galvanized steel mounting pipes and accessories, control panel transformers, auxiliary relays, cables, and junction boxes.

3-1.02.03. Plunger Pumps. Not used.

3-1.03. Circular Sludge Collecting Mechanism. Not used.

3-1.04. Straight Line Sludge Collecting Mechanism. Not used.

3-1.05. Submersible Mixers. Not used.

3-1.06. Plate Settlers. Not used.

3-1.07. Surface Aeration Equipment. Not used.

3-1.08. Diffused Aeration Equipment. Not used.

3-1.09. Multistage Centrifugal Blowers. Not used.

3-1.10. Engine-Generators.

3-1.10.01. Cleaning. The exposed finish shall be inspected after completing system installation, including pipe connections, fittings, valves, and specialties. Burrs, dirt, and construction debris

shall be removed and damaged finishes, including chips, scratches, and abrasions shall be repaired.

3-1.10.02. Protection. The equipment shall be protected after installation, but prior to final acceptance by Owner. Protection provisions shall be as recommended by the manufacturer and shall include provisions to prevent rust, mechanical damage, and foreign objects entering the equipment.

3-1.11. Water Pressure Booster Systems. Not used.

3-2. STARTUP AND TESTING. Startup requirements, and tests associated with startup shall be as indicated in the Startup Requirements section. Other field tests shall be as indicated in the specific equipment sections. Startup and tests required shall occur in the order listed in the following paragraphs. Tests shall not begin until any installation supervision and installation checks by the equipment manufacturer have been completed, except where noted below.

3-2.01. Preliminary Field Tests. Preliminary field tests shall be conducted on all equipment by Contractor as indicated in the Startup Requirements section. When an installation check is specified in the equipment sections, the equipment manufacturer's representative will participate in these tests to the extent described in the Startup Requirements section and in the equipment sections.

3-2.02. Field System Operation Tests. Field system operation tests shall be conducted on all equipment by Contractor as indicated in the Startup Requirements section. When an installation check is specified in the equipment sections, the equipment manufacturer's service personnel will participate in these tests to the extent described in the Startup Requirements section and in the equipment sections.

3-2.03. Field Demonstration Tests. Field demonstration tests will be conducted by the equipment manufacturer on equipment as indicated and as specified in the equipment sections.

3-2.04. Field Performance Tests & Distribution Tests. Field performance tests or distribution tests will be conducted by the equipment manufacturer on equipment as indicated and as specified in the equipment sections.

3-2.05. Field Baseline Performance Tests. Field baseline performance tests shall be conducted by Contractor on the equipment indicated in the equipment sections, and the tests shall be performed as indicated. When indicated in the equipment sections, the equipment manufacturer will participate in these tests. This test shall not be considered an acceptance test, but rather a test to determine initial performance curves and efficiency just prior to the equipment entering service.

End of Section

Section 11150

SUBMERSIBLE PUMPS

PART 1 - GENERAL

1-1. SCOPE. This section covers furnishing guiderail mounted, single-stage, submersible, non-clog, end suction centrifugal pumping units and controls as indicated herein or on the drawings.

Pump Station	PS# 3151
Pump Application	Raw Sewage
Number of Pumps	5
Pump Tag Numbers	PSM-3151-1, PSM-3151-2, PSM-3151-3, PSM-3151-4, PSM-3151-5
Location	Wetwell

Each pumping unit shall be complete with a close-coupled, submersible electric motor, and all other appurtenances specified, or otherwise required for proper operation.

Each pumping unit, including motor and all integral controls, shall be rated and labelled for use in a Class 1, Division 1, Group D area as defined by the National Electric Code.

1-2. GENERAL. Equipment furnished under this section shall be fabricated and assembled in full conformity with drawings, specifications, engineering data, instructions, and recommendations of the equipment manufacturer, unless exceptions are noted by Engineer. Hydraulic considerations and definition of terms shall be as set forth in the Hydraulic Institute Standards.

Pumping units shall be manufactured by Flygt, or ABS without exception.

1-2.01. General Equipment Stipulations. The General Equipment Stipulations shall apply to all equipment furnished under this section. If requirements in this specification differ from those in the General Equipment Stipulations, the requirements specified herein shall take precedence.

1-2.02. Tagging. Each item of equipment and each part shipped separately shall be tagged and identified with indelible markings for the intended service. Tag numbers shall be clearly marked on all shipping labels and on the outside of all containers.

1-2.03. Power Supply. Unless otherwise indicated, power supply to the equipment shall be 480 volts, 60 Hz, 3 phase.

1-3. SUBMITTALS.

1-3.01. Drawings and Data. Complete fabrication and assembly drawings, together with detailed specifications and data covering materials, parts, devices, and accessories forming a part of the equipment furnished, shall be submitted in accordance with the Submittals section. The data and specifications for each unit shall include, but shall not be limited to, the following:

Pumps

Name of manufacturer.
Type and model.
Tag number.
Pump designation.
Pump location.
Rotative speed.
Size of discharge nozzle.
Net weight of pump and motor only.
Complete performance curves showing capacity versus head, NPSH required, pump efficiency, wire-to-water efficiency, and pump input power.
Data on shop painting.

Motors

Name of manufacturer.
Type and model.
Type of bearings and method of lubrication.
Rated size of motor, hp, and service factor.
Insulation class and temperature rise.
Full load rotative speed.
Efficiency at full load and rated pump condition.
Full load current.
Locked rotor current.
Nameplate data as stipulated by NEMA MG-1.

Adjustable Frequency Drives

As specified in the Adjustable Frequency Drives section.

Moisture Detection System

Name of manufacturer.
Type and model.
Enclosure rating and layout if an enclosure is specified.
Electrical schematics and wiring diagram.
Published descriptive data on each item of equipment and all accessories, indicating all specific characteristics and options.

Control Components

Type and manufacturer.
Model.
Enclosure rating.
Published descriptive data on all components, indicating all specific characteristics and options.
Where liquid level sensors are provided, provide mounting details.

1-3.02. Operation and Maintenance Data and Manuals. Adequate operation and maintenance information shall be supplied as required in the Submittals section. Operation and maintenance manuals shall be submitted in accordance with the Submittals section. The operation and maintenance manuals shall be in addition to any instructions or parts lists packed with or attached to the equipment when delivered.

1-4. QUALITY ASSURANCE.

1-4.01. Balance. All rotating parts shall be accurately machined and shall be in as nearly perfect rotational balance as practicable. Excessive vibration shall be sufficient cause for rejection of the equipment. The mass of the unit and its distribution shall be such that resonance at normal operating speeds is avoided. In any case, the unfiltered vibration velocity, as measured at any point on the machine including top of motor, shall not exceed the maximum velocity as indicated for vertical, end suction, solids handling pumps in Figure 9.6.4.10 of the governing standard.

At any operating speed, the ratio of rotative speed to the critical speed of a unit or its components shall be less than 0.8 or more than 1.3.

1-5. DELIVERY, STORAGE, AND HANDLING. Shipping shall be in accordance with the Shipping section. Handling and storage shall be in accordance with the Handling and Storage section.

1-6. SPARE PARTS. One set of all special tools required for normal operation and maintenance shall be provided. All such tools shall be furnished in a suitable steel chest complete with lock and duplicate keys.

One set of spare parts for each pump station (2) shall be provided. Each set of spare parts shall include:

- 1 – Upper bearings
- 1 – Lower bearings
- 1 – Set of upper and lower shaft seals
- 1 – Set of o-rings or gaskets required for replacement of bearings and seals
- 1 – Set impeller wear ring
- 1 – Shaft sleeve (if applicable); and
- 1 – Cable cap for each pump (if applicable)

Spare parts shall be suitably packaged with labels indicating the contents of each package. Spare parts shall be delivered to Owner as directed.

PART 2 - PRODUCTS

2-1. SERVICE CONDITIONS. The equipment provided under this section shall be suitable for the following service conditions:

Site elevation:				
PS#3151	104.5	Feet	MSL	

All equipment furnished shall be designed to meet all specified conditions and to operate satisfactorily at the elevation indicated.

2-2. PERFORMANCE AND DESIGN REQUIREMENTS. Pumping units shall be designed for the performance and design requirements as follows:

Pump tag numbers.	PSM-3151-1 PSM-3151-2 PSM-3151-3 PSM-3151-4 PSM-3151-5	
Rated head.	80	ft
Capacity at rated head.	1000	gpm
Operating head range for full speed continuous operation.	20.5 to 82	ft
Minimum shutoff head.	97.8	ft
Maximum nominal pump speed.	1200	rpm
Minimum head at reduced speed.	59	ft
Capacity at minimum head at reduced speed.	750	gpm
Approximate minimum pump speed.	85	%
Maximum power required at pump input shaft at any point from minimum operating head to shutoff head.	60	bhp
Approximate minimum efficiency at rated head, wire to water.	40	%
Wetwell depth (guide-rail mounted).	21.67	ft
Minimum liquid depth in wetwell (guide-rail and skid mounted)	3.18	ft
Pump designed for reverse rotation at rated head.	No	
Minimum NSPHA .	35	ft
Maximum vibration velocity.	HIS	
Minimum pump discharge nozzle/elbow size.	8	in
Minimum test sphere diameter.	3	in

All specified conditions shall be at rated speed unless otherwise indicated.

Overall (wire-to-water) efficiency shall include losses in the pump and motor.

The minimum hydrostatic test pressure shall be 1.5 times shutoff head plus max suction pressure.

Pump performance shall be stable and free from cavitation and noise throughout the specified operating head range at minimum suction submergences. The design running clearance between the impeller inlet and the casing wearing ring (if provided) shall be not less than 0.01 inch or 1 mil per inch of casing wearing ring diameter, whichever is greater.

2-3. MATERIALS.

Stator Housing, Oil Chamber Housing, Impeller Casing, and Impeller	Cast iron, ASTM A48, Class 30.
Casing Wearing Ring	Martensitic stainless steel, Brinell 300+.
Impeller Wearing Ring	Martensitic stainless steel, Brinell 200-250.
Shaft	Alloy steel, hard chrome plated; or martensitic stainless steel, AISI Type 416 or 420.
Mechanical Seals	2 tandem single type, oil lubricated with silicon or tungsten carbide seal rings at all points, except the upper rotating seal, which shall be carbon.
Discharge Base	Cast iron or fabricated steel.
Guiderails	Stainless steel pipe, ASTM A312, Schedule 40S.
Upper guiderail bracket, cable hooks, and chain hooks	AISI Type 304 stainless steel.

2-4. PUMP CONSTRUCTION.

2-4.01. Impeller Casing. The impeller casing shall have well-rounded water passages and smooth interior surfaces free from cracks, porosity, blowholes, or other irregularities. The discharge nozzle shall be flanged and sufficiently rigid to support the pumping unit under all operating conditions.

2-4.02. Impeller. The impeller shall be an enclosed one-piece casting with not more than two nonclog passages. The interior water passages shall have uniform sections and smooth surfaces and shall be free from cracks and porosity. The impeller shall be dynamically balanced and securely locked to the shaft by means of a key and self-locking bolt or nut.

2-4.03. Wearing Rings. Renewable wearing rings shall be provided in the casing and on the impeller. The rings shall be positively locked in place.

2-4.04. Oil Chamber Housing. The oil chamber shall contain a drain plug and a vent plug.

2-4.05. Mechanical Seals. Each pump shall be provided with two mechanical rotating shaft seals arranged in tandem and running in an oil chamber. Each interface shall be held in contact by an independent spring system designed to withstand maximum suction submergence. The seals shall require neither maintenance nor adjustment and shall be readily accessible for inspection and replacement.

Shaft seals lacking positively driven rotating members or conventional double mechanical seals which utilize a common single or double spring acting between the upper and lower units and requiring a pressure differential to offset external pressure and effect sealing, will not be acceptable. The seals shall not rely upon the pumped media for lubrication and shall not be damaged if the pumps are run unsubmerged for extended periods while pumping under load.

2-4.06. Sealing of Mating Surfaces. All mating surfaces of major components shall be metal to metal. The use of O-rings, gaskets, or seals to obtain and maintain compression and watertightness will not be acceptable. The use of secondary sealing compounds, gasket cement, grease, or other devices to obtain watertight joints will not be acceptable.

2-4.07. Guiderail Mounted Base. A discharge base and discharge elbow shall be furnished by the pump manufacturer. The base shall be sufficiently rigid to firmly support the guiderails, discharge piping, and pumping unit under all operating conditions. The base shall be provided with one or more integral support legs or pads suitable for bolting to the floor of the wetwell. The face of the discharge elbow inlet flange shall be perpendicular to the floor and shall make contact with the face of the pump discharge nozzle flange. The diameter and drilling of the elbow outlet flange shall conform to ANSI B16.1, Class 125.

The pump and motor assembly shall be automatically connected to and supported by the discharge base and guiderails so that the unit can be removed from the wetwell and replaced without the need for operating personnel to enter the wetwell.

2-4.07.01. Sliding Bracket. Each guiderail mounted pumping unit shall be provided with an integral, self-aligning guiderail sliding bracket. The bracket shall be designed to obtain a wedging action between flange faces as final alignment of the pump occurs in the connected position. The bracket shall maintain proper contact and a suitably sealed connection between flange faces under all operating conditions. The sliding bracket shall be nonsparking where the pump is installed in a hazardous area.

2-4.07.02. Guiderails. Each guide rail mounted pumping unit shall be equipped with one or more guiderails. Guiderails shall be sized to fit the discharge base and the sliding bracket and shall extend upwards from the discharge base to the location indicated on the drawings. An upper guiderail bracket shall be provided at the pump access opening.

2-4.07.03. Lifting Chain. Each guide rail mounted pumping unit shall be provided with a chain and cable suitable for removing and installing. Each pump shall be fitted with 6 feet of Type 316 stainless steel, 3/4" chain attached to the lifting mechanism and aircraft rated 1/4" stainless steel cable provided between the cable holder and the chain. A suitable chain hook shall be provided at the top of the wetwell.

2-4.08. Pedestal Mounted Base. Not used.

2-4.09. Skid Mounted Base. Not used.

2-4.10. Access Hatch Cover. Access hatch covers are specified in the Access Hatches section.

2-4.11. Shop Painting. All iron and steel parts which will be in contact with pumped liquid or submerged after installation, including the inside of the casing, the impeller, and the discharge elbow, shall be shop cleaned in accordance with the coating manufacturer's recommendations and painted with the epoxy coating system specified. The coating shall have a dry film thickness of at least 10 mils [250 µm] and shall consist of a prime (first) coat and one or more finish coats. At least 1 quart [1 L] of the finish coat material shall be furnished with each pump for field touch-up.

The shop painting of other surfaces shall be in accordance with the shop painting requirements in the General Equipment Stipulations.

2-4.12. Hoist Assembly. Not used.

2-5. ELECTRIC MOTORS. Each pump shall be driven by an air-filled, totally submersible electric motor provided by the pump manufacturer. Motor nameplate rating shall exceed the maximum power required by the pump in the operating head range. Each motor shall be rated for the power supply provided to the pump, and shall have a service factor of 1.15. The stator housing shall be an air-filled, watertight casing. A cooling jacket shall encase the motor housing for each pump where needed to maintain adequate cooling. The cooling jacket shall require no external source of cooling water. Motor insulation shall be moisture resistant, Class F, 155°C. Each motor shall be NEMA Design B for continuous duty at 40°C ambient temperature, and designed for at least 10 starts per hour.

The motor bearings shall be antifriction, permanently lubricated type. The lower bearing shall be fixed to carry the pump thrust and the upper bearing free to move axially. The bearings shall have a calculated AFBMA L₁₀ Life Rating of 40,000 hours when operating at maximum operating head. Maximum shaft runout at the mechanical seals shall not exceed 2 mils [50 µm] at any point in the operating head range.

Each motor installed in a wetpit shall be capable of continuous operation in air (unsubmerged) for at least 24 hours under pump full load conditions, without exceeding the temperature rise limits for the motor insulation system.

Each pump shall be equipped with one or more multiconductor cable assemblies for power and control. Each multiconductor assembly containing power cables shall be provided with a separate grounding conductor. Each cable assembly shall bear a permanently embossed code or legend indicating the cable is suitable for submerged use. Cable sizing shall conform to NEC requirements.

All cables for wetwell mounted pumps shall be of sufficient length to terminate in a junction box outside the wetwell as indicated on the drawings, with 10 feet of slack which will be coiled on a cable hook at the top of the wetwell. Each cable shall be supported by AISI Series 300 corrosion-resistant stainless steel Kellems or woven grips to prevent damage to the cable insulation. Mounting of cable supports in the wetwell shall be coordinated by Contractor to prevent damage to the cable.

The cable entry water seal shall include a strain relief and a grommet type seal designed so that a specific fastener torque is not required to ensure a watertight, submersible seal. The cable entry

junction box and motor shall be separated by a stator lead sealing gland or a terminal board. The junction box shall isolate the motor interior from moisture gaining access through the top of the stator housing.

Motors shall be specifically selected for service with an adjustable frequency type speed controller when indicated on the drawings and shall be derated to compensate for harmonic heating effects and reduced self-cooling capability at low speed operation so that the motor does not exceed Class B temperature rise when operating in the installed condition at load with power received from the adjustable frequency drive. All motors driven by adjustable frequency drives shall be supplied with full phase insulation on the end turns and shall meet the requirements of NEMA MG 1, Part 31. In addition to the requirements of NEMA MG 1, Part 31, motors shall be designed to be continually pulsed at the motor terminals with a voltage of 1600 volts ac.

2-5.01. Adjustable Frequency Drives. Adjustable frequency drives, shall be coordinated with the requirements of the pumping unit. The pump manufacturer shall be responsible for furnishing the adjustable frequency drive, for matching the motor and the drive, and for coordinating the collection of data and the design to limit harmonics to the levels specified.

Adjustable frequency drives shall be as specified in the Adjustable Frequency Drives section.

2-6. CONTROLS.

2-6.01. Liquid Level Sensors. Sensors shall be in accordance with the Pressure and Level Instruments Section.

2-6.02. Pump Controls. Each motor shall be protected by one motor temperature switch embedded in each phase winding. Each switch shall be designed to operate at 140°C ($\pm 5^\circ\text{C}$). Each switch shall be normally closed automatic reset type rated 5 amps at 120 volts ac. The switches shall be wired in series with end leads wired to terminals within the motor housing.

Each motor housing shall be provided with a moisture detection system complete with all sensors, control power transformers, intrinsically safe control modules, and relays. The moisture detection system shall be rated for a 120 volt ac supply. The moisture detection system shall provide two normally open dry output contacts rated 5 amps at 120 volts ac. The contacts shall close when moisture is detected in the motor housing. All moisture detection system components shall be furnished by the pump supplier and shall be shipped loose for installation into the motor controller enclosure.

2-7. SHOP TESTS. Each pump shall be tested at the factory for capacity, power requirements, and efficiency at specified rated head, shutoff head, operating head extremes, and at as many other points as necessary for accurate performance curve plotting. All tests and test reports shall conform to the requirements and recommendations of the Hydraulic Institute Standards. Acceptance testing shall be Level A, with no minus tolerance or margin allowed.

Five certified copies of a report covering each test shall be prepared by the pump manufacturer and delivered to Engineer not less than 10 days prior to the shipment of the equipment from the factory. The report shall include data and test information as stipulated in the Hydraulic Institute Standards, copies of the test log originals, test reading to curve conversion equations, and

certified performance curves. The curves shall include head, bhp [brake kW], pump efficiency, and shop test NPSH available, plotted against capacity. The curves shall be easily read and plotted to scales consistent with performance requirements. All test points shall be clearly shown.

PART 3 - EXECUTION

3-1. INSTALLATION. Each pumping unit will be installed in accordance with the Equipment Installation section.

3-2. FIELD QUALITY CONTROL.

3-2.01. Installation Check. An experienced, competent, and authorized representative of the manufacturer shall visit the site of the Work and inspect, check, adjust if necessary, and approve the equipment installation. The representative shall be present when the equipment is placed in operation in accordance with Section 01650, Startup Requirements, and shall revisit the job site as often as necessary until all trouble is corrected and the equipment installation and operation are satisfactory in the opinion of Engineer.

The manufacturer's representative shall furnish a written report certifying that the equipment has been properly installed and lubricated; is in accurate alignment; is free from any undue stress imposed by connecting piping or anchor bolts; and has been operated under full load conditions and that it operated satisfactorily.

All costs for these services shall be included in the contract price.

3-2.02. Installation Supervision. Installation supervision by the manufacturer is not required.

End of Section

This page was left blank intentionally

STAINLESS STEEL SLUICE GATES

PART 1 – GENERAL

1-1. SCOPE. This section covers furnishing stainless steel sluice gates and actuators as specified herein and as indicated in the Sluice Gate Schedule. Sluice gates shall be furnished complete with frames, slides, seals, operating stems, stem guides, actuators, baseplates, anchor bolts, and appurtenances as specified herein, as indicated in the schedule and as specified in the Valve and Gate Actuator section.

1-2. GENERAL. Equipment furnished under this section shall be fabricated, assembled, erected, and placed in proper operating condition in full conformity with drawings, specifications, engineering data, instructions, and recommendations of the equipment manufacturer unless exceptions are noted by the Engineer.

Gates and actuators shall be furnished with all necessary parts and accessories indicated on the drawings, specified, or otherwise required for a complete, properly operating installation and shall be the latest product of a manufacturer regularly engaged in the production of stainless steel sluice gates.

Fabricated stainless steel sluice gates shall be manufactured by B.N.W. “Model 77” or Fontaine “Model 20”.

1-2.01. General Equipment Stipulations. The General Equipment Stipulations shall apply to all equipment furnished under this section. If requirements in this specification differ from those in the General Equipment Stipulations, the requirements specified herein shall take precedence.

1-2.02. Governing Standard. Except as modified or supplemented herein, all sluice gates shall conform to the applicable requirements of ANSI/AWWA C561.

1-2.03. Permanent Number Plates. Each gate shall be provided with a number plate, with at least 1 inch high black baked enamel numerals on anodized aluminum plate. The location of number plates and the method of attachment shall be acceptable to the Engineer. The number assigned to each gate shall be as indicated in the Sluice Gate Schedule at the end of this section.

1-3. SUBMITTALS. Complete drawings, construction details, and specifications covering the sluice gates and appurtenances shall be submitted in accordance with the Submittals section. Each drawing shall be identified with the corresponding gate designation.

Drawings shall include separate wiring diagrams for each electrically operated gate and related electrical components.

1-4. DELIVERY, STORAGE, AND HANDLING. Shipping shall be in accordance with the Shipping section. Handling and storage shall be in accordance with the Handling and Storage section.

In addition, frames shall be provided with corner bracing, plywood sheet backing, or other means to hold the frames in proper alignment during shipment and installation. The bracing or backing shall be factory applied and will not be removed until after the frames have been installed in the structures.

PART 2 – PRODUCTS

2-1. SERVICE CONDITIONS. The stainless steel sluice gates will be installed in submersible wastewater pump stations. One at the influent to each wetwell to allow each wetwell to be isolated for maintenance and one in the common wall between the wetwells.

2-2. PERFORMANCE AND DESIGN REQUIREMENTS. Sluice gates, actuators, and appurtenances shall be designed for the conditions and requirements indicated in the Sluice Gate Schedule and as shown on the Contract Drawings.

2-2.01. Design. Liberal factors of safety shall be used throughout the design and especially in the design of parts subject to intermittent or alternating stresses. In general, working stresses shall not exceed one-third of the yield point or one-fifth of the ultimate strength of each material.

Gates shall be designed to fit into the structures as indicated on the contract drawings.

Gates shall be designed for the design seating and unseating heads indicated in the schedule. Actuators, regardless of type, shall be sized to produce the torque or thrust required to operate the applicable gate when the gate is subject to the seating and unseating operating heads set forth in the schedule. The maximum output torque or thrust provided by the actuator shall not exceed 150 percent of that required to operate the gate under the design conditions.

The design head shall be measured from the surface of the liquid to the invert of the gate.

2-2.02. Minimum Metal Thickness. Where so indicated in the governing standard, the design safety factors pertaining to tensile, compressive, and shear strength of materials used shall be observed. In addition, unless otherwise acceptable to the Engineer, all portions of submerged components of each gate, exclusive of stem guide wall brackets, shall have a metal thickness of at least 1/4 inch.

2-2.03. Leakage. Maximum allowable leakage of sluice gates shall not exceed 0.10 gallon per minute per foot of wetted perimeter at any head up to the maximum seating head specified.

2-3. MATERIALS.

Frames, Guides, Slides, and
Reinforcing Members

Stainless steel, AISI Type 316L.

Slide Seats and Bearing
Bars

Ultra-high Molecular Weight
(UHMW) Polyethylene.

Closure Seal	Material suitable for hydrogen sulfide (wet environment); EPDM or Viton.
Load Pads	Material suitable for hydrogen sulfide (wet environment); EPDM or Viton.
Seal Retainer Bar	Stainless steel, AISI Type 316.
Hardware	Stainless steel, AISI Type 316. All bolts used to fasten the seals shall be hex-head type. Round head type are not acceptable.
Operating Stems and Couplings	Stainless steel, AISI Type 316.
Stem Covers	Transparent butyrate plastic pipe.
Stem Support Brackets	Stainless steel, AISI Type 316L.
Assembly Fasteners	Stainless steel, ASTM F593 and F594, Type 316.
Grout	As specified in the Grout section.
Thread Lubricant	John Crane "Thred Gard Nickel" or Crawford "Silver Goop" antiseize compound.

2-4. CONSTRUCTION. All stainless steel shall be pickled at the mill in accordance to ASTM A380 before being shipped. After fabrication, surfaces shall be cleaned of all lubricants, grease pencil marks, magic marker, oils, tape, paint, or other organic materials of any type.

All stainless steel surfaces after fabrication shall be either pickled in accordance with ASTM A380 or given a uniform abrasive grit blast to a profile of 2 to 3 mils, providing a uniform matte finish, using only new blast media which is certified iron-free. Blasting grit shall be black beauty non-metallic 20 - 40 grit as manufactured by Reed Mineral Company or equal. Blasting shall clean the entire surface and produce an even color, texture, and sheen.

A 24 hour water test or the ferroxyl test shall be performed to determine the presence of residual embedded iron. The method of touch-up, spot pickling, and pickling paste used to remove embedded iron, heat tint, and weld oxides shall comply with ASTM A380, Table A2.1, Part II.

All surfaces shall be adequately protected during fabrication, handling, shipping, and installation to prevent contamination from iron or carbon steel objects, tools, cables, or surfaces.

2-4.01. Frames. Each frame shall be an integral unit of extruded or welded structural shapes having a thickness of not less than 1/4 inch. Gate frames shall be of the configurations listed in

the Sluice Gate Schedule. Frames shall be designed for embedment in concrete or installation on the face of concrete walls as required in the Sluice Gate Schedule. Embedded frames shall be recessed so that the waterway is not obstructed.

Guides shall be provided on each side of each frame. Guides shall be sufficiently strong so that no further reinforcing will be required where the guides extend above the operating floor.

Guides shall support the entire height of the slide in all positions.

Full-length plastic slide seats or bearing bars shall be provided on both sides of the slide. Seats and bars shall be securely held in the guides by permanent mechanical fasteners evenly spaced along the height of the guides.

2-4.02. Slides. Slides shall have a thickness of not less than 1/4 inch and shall be provided with welded stiffeners to limit deflection to 1/720 of the gate width under the maximum seating or unseating head specified. Slides shall be adequately reinforced to withstand, without permanent distortion, the maximum thrust which can be transmitted by the operating stem. Each slide shall have a reinforced pocket or internally threaded nut welded to the slide for connection of the stem. The pocket or nut shall be designed to withstand the maximum thrust which can be transmitted by the operating stem. A minimum safety factor of 5 shall be used with regard to tensile, compressive and shear strength of the plate, members, and welds.

2-4.03. Seals. Gates shall be provided with full-length plastic seats or bearing bars on both faces of the slide. Seats and bars shall be securely attached to the frame with stainless steel retainers and/or stainless steel bolts.

Seals shall be capable of being replaced on site without removing the gate frame or slide from the structure. If a retainer bar is used to fasten the seal to the frame or slide, it shall have adjustable screws keeping the seal in compression. The seal design shall be the standard design of the manufacturer, provided it meets the leakage requirements of the governing standard.

2-4.04. Seating Faces. Seat bearing area shall have a minimum width of 1/2 inch. Seating faces shall be secured to either the gate frame or slide, but not both, to ensure that they will remain in place without becoming distorted or loose during the life of the gate. On site replacement of the seating faces must be possible without removing the gate frame from the structure.

2-4.05. Closures. The bottom of each sluice gate frame shall be of the configuration listed in the Sluice Gate Schedule. A compressible seal shall be securely attached to the bottom of the slide or to the frame invert. The seal shall be of sufficient length to seal the bottom corners of each slide.

Each seal shall be provided with a full-length retainer bar which shall compress the seal and prevent leakage between the seal and the frame member. Seals shall be securely attached to the frame and shall permit replacement of the seals without disassembling or removing the gate.

2-4.06. Operating Stems. Operating stems shall conform to the requirements of Section 4.4.11 of AWWA C561 except as modified herein. Stems shall be a minimum 1-1/2 inch diameter solid bar and be designed so that the slenderness ratio (L/R) shall be no greater than 200. Pipe or bar extensions for the stems will not be acceptable. Contact surfaces of threads shall be rolled or

machined and polished to a 63 microinch finish, or smoother. Each stem shall be securely attached to the slide.

Stems shall be of sufficient size to withstand, without damage or permanent distortion, the tensile and compressive stresses resulting from the application of 1.25 times the output thrust of the actuator in the stalled motor condition.

2-5. ACTUATORS. Actuators and their accessories shall be the type as indicated in the Stainless Steel Sluice Gate Schedule and as specified in the Valve and Gate Actuator section.

2-6. SHOP PAINTING. All surfaces of aluminum which will be in contact with concrete, mortar, grout, or dissimilar metals shall be given a heavy coat of epoxy coating. The epoxy coating shall be NSF certified for gates installed in a potable water facility.

2-7. SHOP TESTING. Gates shall be completely assembled in the shop to ensure that all parts fit together properly.

PART 3 – EXECUTION

3-1. INSTALLATION. Sluice gates and appurtenances shall be installed in accordance with the Gate Installation section.

3-2. INSTALLATION CHECK. An experienced, competent, and authorized representative of the manufacturer shall visit the site of the Work and inspect, check, adjust if necessary, and approve the equipment installation. The representative shall be present when the equipment is placed in operation in accordance with Startup Requirements section, and shall revisit the jobsite as often as necessary until all trouble is corrected and the equipment installation and operation are satisfactory in the opinion of Engineer.

The manufacturer's representative shall furnish a written report certifying that the equipment has been properly installed and lubricated; is in accurate alignment; is free from any undue stress imposed by connecting piping or anchor bolts; and has been operated under full load conditions and that it operated satisfactorily.

All costs for these services shall be included in the contract price.

3-3. ABBREVIATIONS. Abbreviations used in the Stainless Steel Sluice Gate Schedule are defined as follows:

(1) Service abbreviations:

SO - Shutoff, gate will normally be fully open or closed

(2) The nominal size does not include any projection in the guides.

- (3) The indicated seating and unseating pressures are the maximum differential head measured above the center line of the gate.
- (4) Abbreviations for frame types and shapes:
- FLR - Flanged, rectangular
- (5) Abbreviations for types of actuator:
- SE - Standard electric
- (6) Abbreviations for types of mounting:
- DFSC - Downward closing, face (wall) mounted, self-contained
- (7) Abbreviations for types of stem operation:
- RS - Rising stem
- (8) Abbreviations for electronic or electric actuator housing:
- WP - Weather proof
- (9) Abbreviations for control devices are as indicated:

Table 1: Control Devices				
Abbreviations	Open-Close Push Button	Open-Stop-Close Push	Local-Off-Remote	Red and Green Indicator Lights
A	Required		Required	Required
B	Required		Required	
C		Required	Required	Required
D		Required	Required	
E		Required		
F	Required			
G	Required			Required
H		Required		Required

3-4. STAINLESS STEEL SLUICE GATE SCHEDULE.

Gate No.	Location	Service	Nominal Size, WxH	Maximum Head, Depth of Water		Invert Elevation (Hole)	Operating Floor EL	Type of Mounting	Type of Actuator	Type of Stem Operation	Electric Actuator Housing	Control Devices
				Seating Feet	Unseating Feet							
	(1)		(2)	(3)	(3)	Feet	Feet	(4) (6)	(5)	(7)	(8)	(9)
GSC-3151-01	3151 Splitter	SO	36" X 36"	18.25	18.25	86.50	104.5	DFSC, FLR	SE	RS	WP	H
GSC-3151-02	3151 Splitter	SO	36" X 36"	18.25	18.25	86.50	104.5	DFSC, FLR	SE	RS	WP	H
GSC-3151-03	3151 Wet Well	SO	24" X 24"	18.25	18.25	86.50	104.5	DFSC, FLR	SE	RS	WP	H

End of Schedule

This page was left blank intentionally

Section 11354

CARBON ADSORPTION UNITS

PART 1 - GENERAL

1-1. SCOPE. This section covers the furnishing and installation of carbon adsorption odor control systems complete with accessories to be furnished and installed as part of the odor control system as indicated on the Drawings and specified herein. The requirements of this section shall apply to the indicated equipment and systems, including interconnecting piping, controls, and accessories required for a complete and properly operating system.

All components items of the odor control system shall be provided by a single odor control system supplier who shall be responsible for the design, coordination, and function of the system.

1-2. GENERAL. Equipment furnished and installed under this section shall be fabricated, assembled, erected, and placed in proper operating condition in full conformity with the Drawings, Specifications, engineering data, instructions, and recommendations of the equipment manufacturer unless exceptions are noted by Engineer.

1-2.01. Coordination. All Equipment provided in this section shall be coordinated with other components of the applicable odor control system. The odor control systems supplier shall verify that each component of the system is compatible with all other components of the system; that all pipe, fans, dampers, valves, motor sizes, and materials are appropriate; and that all devices necessary for a properly functioning system have been provided.

Where two or more units of the same class of equipment are required, they shall be the product of a single manufacturer; however, all the component parts of the system need not be the products of one manufacturer.

Each manufacturer of major equipment shall have a local service center, or with written consent of Engineer, shall be able to provide service from other locations within 24 hours. The service center shall be equipped and staffed to service the system and shall have an available supply of replacement media and equipment parts. Information on equipment manufacturers' representatives shall be included with the submittals.

Where several manufacturers' names have been listed in this section as possible suppliers, only the products of the first manufacturer listed have been checked for size, functions, and features.

1-2.02. General Equipment Stipulations. The General Equipment Stipulations shall apply to all equipment and materials furnished under this section. If requirements in this specification differ from those in the General Equipment Stipulations, the requirements specified herein shall take precedence.

1-2.03. Governing Standards. Except as modified or supplemented herein, all work covered by this section shall be performed in accordance with all applicable municipal codes and ordinances, laws, and regulations. In case of a conflict between this section and any state law or local ordinance, the latter shall govern.

All work shall comply with Underwriters' Laboratories (UL) safety requirements.

1-2.04. Power Supply. Power supply to equipment with motors shall be as indicated in the schedules on the Drawings. Power supply for controls shall be 120 volts, 60 Hz, single phase unless otherwise required for a properly operating system.

1-2.05. Metal Thickness. Metal thickness and gages specified herein are minimum requirements. Gages refer to US Standard gage.

1-2.06. Mechanical Identification. Equipment, valves, panels, and control equipment shall be identified in accordance with the Equipment and Valve Identification section.

1-3. SUBMITTALS.

1-3.01. Drawings and Data. Complete fabrication, assembly and installation drawings, wiring and schematic diagrams, together with detailed specifications and data covering materials, parts, devices, and accessories forming a part of the equipment furnished, shall be submitted in accordance with the Submittals Procedures section. Device tag numbers indicated on the Drawings shall be referenced on the wiring and schematic diagrams where applicable. The data and specifications for each unit shall include, but shall not be limited to, the following:

Carbon Adsorption Vessel

Name of manufacturer.

Type and model.

Vessel dimensions.

Size and location of all connections.

Arrangement of inlet and discharge nozzle connections, access manways, regeneration manifold connection, activated carbon bed, supports, and other appurtenances.

Carbon quantity required for design conditions.

Pressure loss at design airflow.

Net weight.

Foundation bolting details.
Resin type and chemical resistance.

Activated Carbon Media

Carbon substrate.
Base material.
Granule/pellet manufacture process.
Mean particle diameter.
Total ash.
Total surface area.
Impregnated carbon
Apparent density.
Hardness.
Moisture content.
Pressure drop through dense-packed bed at actual face velocity.
Hydrogen sulfide breakthrough capacity.
Purity of impregnating material.

Mist Eliminator

Name of manufacturer.
Materials type, thicknesses, and finishes.
Efficiency.
Size and locations of all connections.
Net weight.

Controls

Published descriptive data on each item of equipment and accessories, indicating all specific characteristics and options and identified with the designation used herein and on the Drawings.
Schematic control diagrams giving specific data on all settings, ranges, actions, adjustments, and normal positions. These diagrams shall, represent the actual system with all significant equipment and devices identified and located relative to each other. These diagrams shall also show detailed multiline wiring, with all terminals accurately identified. Wiring diagrams shall be detailed to the degree required for field construction and shall include all related wiring.
Sequence of operation for each system corresponding to the control schematics.
Detailed panel construction drawings, including description of all materials and finishes, complete internal wiring schematics, panel face layout, and complete data on all mounted components.

1-3.02. Operation and Maintenance Data and Manuals. Operation and maintenance information shall be submitted in accordance with Submittal Procedures section. Equipment designations used shall correspond to those indicated on the drawings. The operation and maintenance manuals shall be in

addition to any instructions or parts lists packed with or attached to the equipment when delivered.

1-3.03. Color Selection. Colors for factory finish of carbon adsorption vessels shall be selected by Engineer from the manufacturer's full range of standard and custom colors. Samples shall be submitted for color selection in accordance with the Submittals Procedures sections.

1-4. QUALITY ASSURANCE.

1-4.01. Performance Tests. Prior to final acceptance, all of the required tests shall be conducted on the odor control media and equipment in accordance with the Field Quality Control paragraph.

1-5. DELIVERY, STORAGE, AND HANDLING. Shipping shall be in accordance with the Product Delivery Requirements section. Handling and storage shall be in accordance with the Product Storage and Handling Requirements section.

PART 2 - PRODUCTS

2-1. SERVICE CONDITIONS. All equipment shall be designed and selected to meet the specified conditions.

Equipment shall be designed to withstand and operate at the wind conditions and seismic requirements indicated in the Meteorological and Seismic Design Criteria section.

The carbon adsorption units shall be suitable for the following service conditions and designed for continuous 24 hour per day operation:

Ambient temperature range.	0 to 120 °F
Environmental exposure.	Outdoor

2-2. PERFORMANCE AND DESIGN REQUIREMENTS. All parts exposed to corrosive conditions shall be made from corrosive-resistant materials.

The carbon units will be used to deodorize malodorous air which contains hydrogen sulfide and other non- H₂S compounds (including but not limited to ammonia, reduced sulfides such as methyl mercaptan and dimethyl sulfide, and other volatile organic compounds), and which is fully saturated with water vapor. Each unit shall be designed for the performance requirements and structural design indicated in the schedules on the Drawings.

2-2.01. Dimensional Restrictions. Layout dimensions will vary between manufacturers and the layout area and arrangement indicated on the Drawings is based on the first manufacturer listed. Contractor shall review the contract Drawings, the manufacturer's layout drawings, and installation requirements and shall make any modifications required for proper installation subject to acceptance by Engineer. At least 3 feet of clear access space shall be provided on all sides of the unit unless otherwise indicated.

2-2.02. Elevation. Equipment shall be designed to operate at the elevation as indicated in the Basic Mechanical Building Systems Materials and Methods section. All equipment furnished for sites above 2000 feet above sea level shall be properly derated to operate and meet the specified capacities at the site conditions.

2-3. ACCEPTABLE MANUFACTURERS. The carbon adsorption vessel and media shall be provided by Bay Products, Pure Air Filtration, Calgon/ECS, Daniel Company, Duall/Met Pro, or Siemens without exception.

2-4. MATERIALS.

2-4.01. Carbon Media. The carbon media shall be activated, pelletized bituminous coal base, vapor-phase type.

2-4.01.01. Virgin Activated Carbon Media. Not used.

2-4.01.02. Potassium Hydroxide Impregnated Carbon Media. Not used.

2-4.01.03. Sodium Hydroxide Impregnated Carbon Media. Not used.

2-4.01.04. Water Washable Carbon Media. Not used.

2-4.01.05. High Capacity Carbon Media. The high capacity carbon media shall be of a type that provides hydrogen sulfide odor control without causing an acute acidic environment. When spent, the carbon bed shall not demonstrate a pH<3. High capacity carbon media shall have the following physical and chemical properties:

<u>CARBON SUBSTRATE</u>	<u>Requirement</u>	<u>Test Method</u>
Apparent density (bulk dense packing) g/cc, minimum density.	0.40	ASTM D2854
Ball-pan hardness number, minimum.	95	ASTM D3802
Mean particle diameter, mm, minimum.	2.8	ASTM D2862
Iodine Number, mgI ₂ /g, minimum.	1050	ASTM D4607

Butane Activity, weight percent, minimum.	26	ASTM D5742
Maximum head loss at 50 fpm face velocity through a dense-packed bed, inches water column / ft bed depth.	2.0	
Hydrogen sulfide breakthrough capacity, g H ₂ S/cc carbon, minimum.	0.30	ASTM D6646

2-5. CONSTRUCTION.

2-5.01. Carbon Adsorption Units. The minimum carbon bed depth shall be 3 feet [0.3m]. Where indicated on the Drawings, dual bed units shall be provided.

2-5.01.01. Carbon Adsorption Vessel. Carbon adsorption vessels shall be constructed of fiberglass reinforced plastic in accordance with ASTM D3299 or ASTM D4097. All vessels shall be arranged for vertical flow. Alternate flow arrangements shall be considered if the total weight of carbon provided and foul air residence time equals or exceeds that of the specified vertical vessel. All fiberglass reinforced plastic fabrications shall have a flame spread of 25 or less when tested in accordance with ASTM E84. The resin used shall be premium vinyl ester suitable for contact with water-saturated air containing hydrogen sulfide at 180°F [82°C]. Resin used in the fabrication of vessels to be installed outdoors shall contain ultraviolet inhibitors.

Each vessel shall be provided with lifting lugs and hold-down brackets for mounting on a concrete base. Each vessel shall be a vertical cylindrical shape with rounded top and flat bottom heads. The vessel top shall be self-supporting, structurally reinforced to withstand a super-imposed load of 250 pounds [115 kg] at any point and shall be additionally reinforced as necessary for the specified accessories. Vessel tops shall be provided with a nonslip finish over the entire top surface. The outlets shall be provided with discharge stacks and rain caps designed to prevent the entry of moisture.

A carbon support system shall be provided inside each vessel. The support system shall consist of nonmetallic, removable grating supported from either the vessel sides or the bottom. Polypropylene mesh shall be installed between the grating and carbon and the top surface of the bottom bed of dual bed units to prevent scouring of media due to the inlet air arrangement. A contact probe, ground lug, and all electrical provisions shall be provided to ground each carbon bed.

2-5.01.02. Connections. All piping connections shall be flanged. Air inlet and outlet connections on each vessel shall conform to ANSI D3982; shall be furnished undrilled; and shall be field drilled to match bolt hole locations on connecting piping. Other flanges for connection to PVC or CPVC piping shall conform to ANSI/ASME B16.1, Class 125 diameter and drilling. The orientation

of the piping connections, inspection manholes, and other appurtenances shall be as indicated on the Drawings.

2-5.01.03. Inspection Manholes. Two 24 inch [600 mm] diameter inspection manholes with flanged covers shall be provided on each containment vessel. One shall be located in the top head and the other in the side. The manhole covers shall be fully gasketed and shall be gastight at the design operating pressure and vacuum specified on the schedules.

2-5.01.04. Sample Probes. Three sample probes shall be provided for each carbon bed. The probes shall extend at least 6 inches [150 mm] into the bed. The probes shall be suitable for extraction of carbon samples and collection of gas samples from the carbon bed and shall be nonblinding. The probes shall extend outside the vessel wall and shall terminate with CPVC, ball type shutoff valves.

2-5.01.05. Ladders and Guardrails. Not used.

2-5.02. CARBON CANISTER UNITS. Not used.

2-6. ELECTRICAL. Motor starters and controls shall be furnished and installed under the Electrical section, except where specified with prewired integral starters. Disconnects for equipment shall be furnished and installed under the Electrical section, except where specified with integral disconnects. All electrical controls shall have enclosures suitable for the environment and NEMA rating as indicated on the electrical Drawings for wiring in conduit. Equipment installed outdoors shall have NEMA Type 4 enclosures.

2-7. CONTROLS. The control systems shall be furnished and installed as indicated on the Drawings and as specified herein. All controls shall consist of electric equipment.

2-7.01. Control Panels. The control panels shall be installed where indicated on the Drawings. Control panels shall be designed for mounting as required, and shall be completely prewired and checked. The control panel shall provide electrical control for the fan and motor driven dampers.

Control panels shall conform to NEMA ICS 1, NEMA ICS 2, NEMA ICS 3, and NFPA 70. Control panels shall be fiberglass construction and shall be rated NEMA 4X. The control panels will be supplied with 120 volts, 60 Hz, single phase power. All electrical accessory devices and internal electrical wiring shall be furnished and installed. All controllers, selector relays, switching relays, interlock relays, manual switches, alarm and indicating lights, and other devices indicated to be panel mounted shall be mounted in or on the respective control panel.

Accessories, such as indicating lights and selector switches, shall be mounted on the front hinged covers of the panels. The accessories and panels shall be identified with engraved phenolic nameplates with 1/4 inch [6 mm] high letters. Twenty-five percent extra terminals shall be provided in each control panel.

2-7.02. Selector Switches. Selector switches shall be Micro Switch "Type PT", Cutler-Hammer "Type T", or General Electric "CR". Selector switches shall be heavy-duty 30 mm oiltight type with gloved-hand or wing lever operators. Position legends shall be engraved on switch faceplate. Switches for electric circuits shall have silver butting or sliding contacts, rated 10 amperes continuous at 120 volts ac. Contact configuration shall be as indicated on the Drawings or as necessary for the application. Switches used in electronic signal circuits shall have contacts suitable for that duty.

2-7.03. Indicating Lights. Indicating lights shall be Micro Switch "Type PT", Cutler-Hammer "10250T", or General Electric "CR". Indicating lights shall be heavy-duty, 30mm push-to-test, oil-tight type, which utilize a low voltage lamp and a built-in transformer. Legends shall be engraved on the lens or on a legend faceplate. Lamps shall be easily replaceable from the front of the indicating light.

2-7.04. Accessory Components. All additional control components, such as electric relays, controllers, and position switches, shall be furnished as needed to ensure a complete, properly operating installation. Accessory components not mounted inside the control panel shall be furnished with equipment enclosures suitable for the environment and NEMA rating as indicated on the electrical Drawings.

2-7.05. Electrical Wiring. Detailed schematic wiring diagrams shall be submitted in accordance with the Submittals section. The wiring diagrams shall show the internal connections of the control panels and all field wiring to equipment remote from the control panels. The wiring diagrams shall be complete, showing all connections necessary to place the control systems in operation.

2-7.06. Nameplates. Phenolic nameplates shall be provided and permanently attached to the wall at each control device to indicate the equipment controlled. The letters used shall be the same as the symbols indicated herein and on the Drawings for various equipment. Each nameplate shall have white letters on a black background.

2-8. ACCESSORIES.

2-8.01. Mist Eliminator. The grease filter / mist eliminator shall consist of an FRP enclosure, fabricated per PS 15-69 utilizing premium vinyl ester resin suitable for the indicated service, with an internal demister assembly consisting of a 316L stainless steel pad in front of a polypropylene pad. The demister efficiency shall provide at least 99.9% removal of particulates equal to or larger

than 10 micron in size. The pads shall be removable for cleaning and the housing shall be flanged or have a door to allow removal and replacement of the filter pads. This unit shall ship loose and be ready for installation into the odor control system supply ductwork. The FRP housing shall be flanged and drilled, and come complete with gaskets, ready for installation. The mist eliminator shall have a maximum initial resistance of 1 inch wc at 400 feet per minute [0.25 kPa at 2.0 m/s]. The mist eliminator and drain line shall be heat traced and insulated as indicated in the Drawings and specifications. The heat tracing shall be suitable for a Class 1, Division 2, Group D atmosphere. The filter/eliminator unit shall be manufactured by Diamond Fiberglass Fabrications, Inc., or equal.

2-8.02. Differential Pressure Gauges. Differential pressure gauges shall be furnished for monitoring the pressure differential across each carbon media bed. The gauges shall be permanently mounted and shall be furnished with a mounting bracket, tubing, and all required fittings. Unless otherwise indicated, the installation hardware shall be Type 316L stainless steel. Tubing shall be 1/2 inch [13 mm] PVC pipe, unless otherwise indicated, properly supported and braced for a permanent installation. Indicators shall be installed approximately 5 feet [1.5 m] above the surrounding floor or concrete slab.

Each gauge shall be of the diaphragm actuated dial type with adjustable pointer, white dial and black figures and markings. Each gauge shall have a range such that under normal operating conditions, the reading is approximately in the middle of the range. Accuracy shall be within 3 percent of full scale. Two shutoff cocks shall be furnished with each gauge.

Condensate drip tubing shall be provided on the high and low pressure lines to each gauge. The condensate drip lines shall extend a minimum 4 inches [100 mm] below the bottom elevation of the gauge and terminate with shutoff valves.

The gauges shall be furnished with a transparent red overlay extending from the maximum allowable differential pressure reading to the end of the range.

Differential pressure gauges shall be Dwyer "Series 4000 Capsuhellic" with diaphragm seal made from a material suitable for exposure to a dry hydrogen sulfide air stream.

2-8.03. Signs. Each carbon adsorption unit shall be provided with the following signs in both English and Spanish:

"CAUTION: IF THIS UNIT IS TAKEN OUT OF SERVICE, THE OUTLET DAMPERS, SAMPLE VALVES, AND OVERFLOW VALVES MUST BE CLOSED TO AVOID DAMAGE DUE TO HIGH TEMPERATURES WITHIN THE UNIT."

"CAUTION: OXYGEN-DEFICIENT ENVIRONMENT DO NOT ENTER THIS VESSEL."

2-9. SEQUENCE OF OPERATIONS. The sequence of operation for the odor control system shall be as indicated on Drawings.

PART 3 - EXECUTION

3-1. INSPECTION. All equipment and accessories shall be inspected for damage and cleanliness before being installed. Any material damaged or contaminated in handling on the job shall not be used unless it is repaired and recleaned to the original requirement by Contractor. Such material shall be segregated from the clean material and shall be inspected and approved by Owner or his representative before its use.

3-2. PREPARATION. For new work at existing facilities, Contractor shall field verify the locations of existing piping, structural members, ductwork, equipment, lighting, conduit, etc., and locate all new piping, ductwork, and equipment to avoid conflicts with such items.

Equipment installed in existing facilities with limited access shall be suitable for being installed through available openings. Contractor shall field verify existing opening dimensions and other provisions for installation prior to submittal of bids.

3-3. INSTALLATION. Each carbon adsorption unit shall be installed in accordance with the recommendations of the manufacturer. The equipment exterior and the surrounding area shall be cleaned after the carbon installation, as needed to remove all carbon dust.

When grouted bases are used, the space beneath baseplates shall be grouted as specified in the Grouting section.

Immediately after the activated carbon is installed, the odor control system shall be operated continuously for 7 days. Each unit shall be sealed and monitored during construction, to prevent carbon bed fires.

3-3.01. Control Panels. Control panels shall be mounted so that selector switches and indicating lights on the panel are located approximately 4'-6" [1.4 m] above the finished floor.

3-3.02. Differential Pressure Gauges. Differential pressure gauges shall be installed to allow gravity drainage of condensate in the sensing lines back to the pipe or vessel. Indicators mounted on towers shall be installed approximately 4'-6" [1.4 m] above the surrounding floor or concrete slab.

3-4. FIELD QUALITY CONTROL.

3-4.01. Carbon Media Testing. A random sample of the carbon delivered to the site will be sent to an independent laboratory for testing. A sample of at least 8 ounces will be shipped in a non-porous container. H₂S capacity testing will be performed according to ASTM D6646. The testing shall be performed by Weck Laboratories, Inc, 14859 East Clark Avenue, City of Industry, CA, 91745-2139, Tel:(626) 336-2139, Fax:(626) 336-2634, E-mail: joe@wecklabs.com, Web site:www.wecklabs.com. All costs associated with the testing will be the responsibility of the Contractor. Should the carbon fail the initial testing, subsequent tests will be paid for by the carbon supplier.

3-5. ADJUSTING. Contractor shall make all adjustments as directed by the equipment manufacturer.

3-5.01. Applied Pipe Stress Test. After final alignment and bolting, all flanged connections shall be tested for applied piping stresses by loosening the flange bolts. No stresses shall be transmitted to the scrubber flanges. If any movement or opening of the joints is observed, piping shall be adjusted to proper fit.

3-5.02. Installation Check. An experienced, competent, and authorized representative of the manufacturer shall visit the site of the Work and inspect, check, adjust if necessary, and approve the equipment installation. The representative shall be present when the equipment is placed in operation in accordance with the Startup Requirements section, and shall revisit the jobsite as often as necessary until all trouble is corrected and the equipment installation and operation are satisfactory in the opinion of Engineer.

The manufacturer's representative shall furnish a written report certifying that the equipment has been properly installed and lubricated; is in accurate alignment; is free from any undue stress imposed by connecting piping or anchor bolts; and has been operated under full load conditions and that it operated satisfactorily.

All costs for these services shall be included in the Contract Price.

3-5.03. Testing and Balancing. Testing and balancing for the odor control systems shall conform to the requirements of the Adjusting and Balancing Odor Control Systems section.

3-6. CLEANING. At the completion of testing, all equipment, pipes, ductwork, valves, and fittings shall be cleaned of grease, debris, metal cuttings, and sludge. Any stoppage, discoloration, or other damage to parts of the building, its finish, or furnishings shall be repaired at no additional cost to Owner.

The inside of all pipe, dampers, and fittings shall be smooth, clean, and free from blisters, sand or dirt when erected. All lines shall be thoroughly air purged before placing in service.

3-6.01. Fabricated Piping Assemblies. Fabricated piping assemblies shall be cleaned to remove all loose foreign materials such as scale, sand, weld splatter particles, or cutting chips by hand or mechanical cleaning.

3-6.02. Installed Piping. All installed piping shall be cleaned and free from debris and any loose foreign materials, as may be introduced during field installation. Installed piping shall be cleaned by hand or by flushing.

3-6. TRAINING. After completion of the field testing, operator instruction and training on equipment and system operation shall be provided. The training should provide a complete overview of all equipment, testing, adjusting, operation, and maintenance procedures. The training shall take the form of classroom instruction and shall cover:

- a. Documentation in the final Operation and Maintenance Manuals.
- b. Use the Operation and Maintenance Manuals.
- c. Equipment and system startup and shutdown.
- d. System operation procedures for all modes of operation.
- e. Procedures for dealing with abnormal conditions and emergency situations for which there is a specified system response.
- f. Regeneration of the carbon units (if applicable).

The training shall take the form of classroom sessions at the project site conducted by the equipment manufacturer representatives who are knowledgeable and familiar with the project. Hands-on instruction and training will be conducted so that actual operation and maintenance of the equipment and systems can be performed by Owner upon completion of the training.

At least two weeks prior to the proposed date for the operator instruction and training session, Contractor shall notify Engineer and shall submit an outline for the proposed operator instruction and training session. The proposed outline shall be approved before any training is conducted.

End of Section

Section 11355

BIOTRICKLING FILTER SYSTEMS

PART 1 - GENERAL

1-1. SCOPE. This section covers the furnishing and installation of biotrickling filters used as part of the odor control system. The system shall be complete with inlet air connections, biofilter vessel, recirculation pumps (if applicable), recirculation/irrigation piping, electrical odor control panel, water control cabinet, nutrient feed system, nutrient tank, and accessories to be furnished and installed as part of the odor control system. In addition, a startup system shall be provided as required during biotrickling filter startup to activate system operation.

The biotrickling filter manufacturer shall be responsible for coordination of all biotrickling filter equipment; controls; biotrickling filter circulation piping; non-potable water supply piping to each unit; valves; pipe supports; plumbing drain locations and piping associated with the biotrickling filter; start-up tank location; piping locations; equipment bases; and other items to provide a completely operating system.

Odor control fans, carbon adsorption units, odor control dampers, fiberglass reinforced plastic pipe for air service, piping, pipe supports, valves, and accessories, which are not an integral part of the biotrickling filter or are not specified herein, are covered in other sections.

All items of the odor control system shall be provided by a single supplier who shall be responsible for the design, coordination, and function of the system.

1-2. GENERAL. Equipment furnished and installed under this section shall be fabricated, assembled, erected, and placed in proper operating condition in full conformity with the Drawings, Specifications, engineering data, instructions, and recommendations of the equipment manufacturer unless exceptions are noted by Engineer.

1-2.01. Coordination. Equipment furnished under this section shall be coordinated with other components of the applicable odor control system. The odor control systems supplier shall verify that each component of the system is compatible with all other components of the system; that all pipe, valves, motor sizes, and materials are appropriate; and that all devices necessary for a properly functioning system have been provided.

Where two or more units of the same class of equipment are required, they shall be the product of a single manufacturer; however, all the component parts of the system need not be the products of one manufacturer.

Each manufacturer of major equipment shall have a local service center, or shall be able to provide service from other locations within 24 hours. The manufacturer shall be equipped and staffed to service the system and shall have an available supply of replacement media and equipment parts. Information on equipment manufacturers' representatives shall be included with the submittals.

Where several manufacturers' names have been listed in this section as possible suppliers, only the products of the first manufacturer listed have been checked for size, functions, and features.

1-2.02. General Equipment Stipulations. The General Equipment Stipulations shall apply to all equipment and materials furnished under this section. If requirements in this specification differ from those in the General Equipment Stipulations, the requirements specified herein shall take precedence.

1-2.03. Governing Standards. Except as modified or supplemented herein, all work covered by this section shall be performed in accordance with all applicable municipal codes and ordinances, laws, and regulations. In case of a conflict between this section and any state law or local ordinance, the latter shall govern.

All work shall comply with Underwriters' Laboratories (UL) safety requirements.

1-2.04. Power Supply. Power supply to equipment with motors shall be as indicated in the schedules on the Drawings. Power supply for controls shall be 120 volts, 60 Hz, single phase power derived from the 480 volts, 60 Hz, 3 phase odor control system supply via a 480:120 volt 1-phase control power transformer, sized as required.

1-2.05. Metal Thickness. Metal thickness and gages specified herein are minimum requirements. Gages refer to US Standard gage.

1-3. MECHANICAL IDENTIFICATION. All equipment, piping, valves, ductwork, panels, and control equipment denoted on the Drawings by a symbol and an identifying number shall be provided with mechanical identification.

1-4. SUBMITTALS.

1-4.01. Drawings and Data. Complete assembly and installation drawings, and wiring and schematic diagrams, together with detailed specifications and data covering materials, parts, devices, and accessories forming a part of the equipment furnished, shall be submitted in accordance with the Submittals section. Device tag numbers indicated on the Drawings shall be referenced on

the wiring and schematic diagrams where applicable. The data and specifications for each unit shall include, but shall not be limited to, the following:

Biotrickling Filter

Name of manufacturer.
Type and model.
Inside diameter.
Overall height.
Size and orientation of all connections.
Media manufacturer, type, and material.
Spray nozzle manufacturer, type, material, and free passage diameter.
Net weight.
Pressure loss vs. airflow performance curves.
Foundation bolting details.
All material types, thickness, and finishes.
Details of all control devices.
Resin type and chemical resistance.

Recirculation Tanks, and Nutrient Tanks

Name of manufacturer.
Inside diameter.
Overall height.
Size and orientation of all connections.
Net weight.
Foundation bolting details.
All material types, thickness, and finishes.
Details of all control devices.
Resin type and chemical resistance.

Pumps

Name of manufacturer.
Type and model.
Rotative speed.
Size of suction and discharge connection.
Recirculation piping system head loss calculations including all losses for piping, valves, equipment, and accessories. Complete performance curves showing capacity versus head, NPSH required, pump efficiency, and bhp.
Type of coupling.
Overall dimensions and total weight of complete pumping unit.
Detailed base fabrication drawings.

Motors

Name and manufacturer.
Type and model.

Bearing type and method of lubrication.
Rated size of motor, hp, and service factor.
Temperature rise and insulation rating.
Full load rotative speed.
Net weight.
Efficiency at full, $\frac{3}{4}$, and $\frac{1}{2}$ loads.
Full load current.
Overall dimensions.
Space heater wattage.

Control Panels and Controls

Published descriptive data on each item of equipment and accessories, indicating all specific characteristics and options and identified with the designation used herein and on the Drawings.
Schematic control diagrams giving specific data on all settings, ranges, actions, adjustments, and normal positions. Although schematic, these diagrams shall, as closely as possible, represent the actual system with all significant equipment and devices identified and located relative to each other. These diagrams shall also show detailed multiline wiring, with all terminals accurately identified. Wiring diagrams shall be detailed to the degree required for field construction and shall include all related wiring.
Sequence of operation for each system corresponding to the control schematics.
Detailed panel construction drawings, including description of all materials and finishes, complete internal wiring schematics, panel face layout, and complete data on all mounted components.

Water Control Cabinets

Name and manufacturer.
Piping and valve arrangement.
Size and orientation of all connections.
Heater manufacturer.
Wiring diagrams.

Other Equipment

Name of manufacturer.
Type and model.
Complete performance data.
Overall dimensions and total weight of complete unit.
Detailed base fabrication drawings.

1-4.02. Operation and Maintenance Data and Manuals. Adequate operation and maintenance information shall be supplied as required in the Submittals section.

The operation and maintenance manuals shall be in addition to any instructions or parts lists packed with or attached to the equipment when delivered.

1-4.03. Color Selection. Colors for factory finish of biotrickling filter vessels shall be selected by Engineer from the manufacturer's full range of standard and custom colors. Samples shall be submitted for color selection in accordance with the Submittals and Protective Coatings sections.

1-5. QUALITY ASSURANCE.

1-5.01. Performance Tests. Prior to final acceptance, all of the required tests shall be conducted on the odor control equipment in accordance with the Field Quality Control paragraph in this section.

1-6. DELIVERY, STORAGE, AND HANDLING. Shipping shall be in accordance with the Shipping section. Handling and storage shall be in accordance with the Handling and Storage section.

1-7. EXTRA MATERIALS. Extra materials shall be furnished for the equipment as follows:

<u>Extra Materials</u>	<u>Quantity</u>
Spray nozzles	3

Extra materials shall be packaged in accordance with the Delivery, Storage, and Handling section, with labels indicating the contents of each package. Each label shall indicate manufacturer's name, equipment name, part nomenclature, part number, address of nearest distributor, and current list price. Extra materials shall be delivered to Owner as directed.

Extra materials subject to deterioration such as ferrous metal items and electrical components shall be properly protected by lubricants or desiccants and encapsulated in hermetically sealed plastic wrapping.

PART 2 - PRODUCTS

2-1. SERVICE CONDITIONS. The biotrickling filters shall be suitable for the following service conditions and designed for continuous operation:

Ambient temperature range.	0 to 120 °F
Environmental exposure.	Outdoor

2-1.01. Ultraviolet Protection. All pipe, tanks, equipment and components of plastic construction shall contain ultraviolet inhibitors.

2-2. PERFORMANCE AND DESIGN REQUIREMENTS. The system shall be capable of removing hydrogen sulfide and other typical non- H₂S sewage odors and compounds (including but not limited to ammonia, reduced sulfides such as methyl mercaptan and dimethyl sulfide, and other volatile organic compounds) from the air stream. The system shall be designed such that no physical sorption systems, chemical oxidation systems, or chemical masking systems are required. The system shall be sized for a minimum residence time of 15 seconds.

The requirements of the biotrickling filter shall be as indicated on the drawings and the performance of the biotrickling filter system shall be as specified herein and as indicated in the schedules on the drawings. The biotrickling filter shall be capable of an H₂S removal efficiency of 99 percent and an overall odor removal of 90% maintained under the variable loading conditions. For inlet H₂S concentrations below 10 ppm a maximum outlet H₂S of 0.10 ppm will be acceptable. The maximum pressure drop listed in the schedules is for the complete unit from inlet flange to outlet flange.

The system shall utilize a synthetic packing material that is resistant to acid conditions and also supports the growth of a bacterial film. The media shall be irrigated or regularly flushed with non-potable water from the potable water system. The biotrickling filter manufacturer shall be responsible for testing the water to identify and quantify contaminants that may impact performance of the system and design the biotrickling filter as required to support the growth of the bacteria.

Hydrogen sulfide and other odorous contaminants shall be removed via mass transfer to the bacterial film with subsequent oxidation to non-odorous compounds. The by-products of the oxidation process shall be removed from the biotrickling filter through regular flushing of the media with the irrigation system.

The biotrickling filter shall consist of one or more foul air plenums, biofiltration media compartment, and an internal irrigation system to facilitate and extend media performance. The biotrickling filters shall be provided with built-in provision for collection and drainage of any filtrate or other materials generated by the biotrickling filter.

2-2.01. Dimensional Restrictions. Layout dimensions will vary between manufacturers and the layout area indicated on the Drawings is based on typical values. Contractor shall review the drawings, the manufacturer's layout

drawings, and installation requirements and shall make any modifications required for proper installation subject to acceptance by Engineer. Maximum vessel height shall not exceed the limit in the schedule on the drawings.

2-3. ACCEPTABLE MANUFACTURERS. The biotrickling filter shall be vertical counter-flow type. Vertical counter-flow biotrickling filters shall be manufactured by Siemens, Bioair Solutions, Met-Pro Duall, or Biorem, without exception.

2-4. CONSTRUCTION.

2-4.01. Biotrickling Filters. Biotrickling filter containment vessels shall be constructed of fiberglass reinforced plastic in accordance with ASTM D3299 or ASTM D4097. All fiberglass reinforced plastic fabrications shall have a flame spread of 25 or less when tested in accordance with ASTM E84. The resin used shall be premium vinyl ester resin suitable for contact with water-saturated air containing hydrogen sulfide and sulfuric acid at 5% at 180°F [82°C]. Resin used in the fabrication of vessels to be installed outdoors shall contain an ultraviolet inhibitor.

The biotrickling filter shall include a flanged air inlet and outlet connections, access openings, and liquid piping connection flanges. The biotrickling filter shall include all connections and components which are required by the manufacturer's design. Each vessel shall be provided with lifting lugs and hold-down brackets for mounting on a concrete base.

The biotrickling filter shall include spray nozzles, irrigation or recirculation system, inspection access openings, a water sample tap off the drain pipe, and a 1/2" [13 mm] treated air sample tap with pipe extending down to approximately 5 feet above the concrete slab with a PVC shutoff valve. Air sample pipe, overflow pipe, and valve size and material shall be as recommended by the biotrickling filter manufacturer. Irrigation or recirculation piping on the outside of each biotrickling filter shall be arranged so that the piping inside the biotrickling filter can be easily removed.

2-4.01.01 Media. The biotrickling filter shall include a minimum of one layer of highly porous, chemically resistant synthetic media material, with additional layers as recommended by the manufacturer to meet the requirements of the Performance and Design Requirements paragraph. The media shall be non-proprietary and readily available to the OWNER. The MANUFACTURER shall provide contact information to procure the media in their submittal. The media shall be self-supporting and removable for inspection, cleaning, or replacement. The media installation shall be constructed to minimize the potential for short-circuiting or bypass of the air being treated. Organic materials such as compost, wood, wood mulch, tree bark, lava rock, or activated carbon will not be acceptable. A media support system shall be provided inside each vessel. The

support system shall consist of nonmetallic, removable grating supported from either the vessel sides or the bottom.

2-4.01.02. Spray Nozzles. One or more spray nozzles shall be installed above the media and shall be arranged and sized to ensure uniform distribution of scrubbing solution throughout the bed. Recirculation/irrigation piping shall enter the vessel through a flanged connection designed for easy removal of piping and nozzles inside the biofilter without entering the vessel. Spray nozzles shall be Teflon, PVC, or polypropylene, with a minimum free passage diameter of 1/4 inch [6 mm], and shall be specifically designed to be clog-resistant. Pressure loss across the nozzle at design capacity shall be no more than 10 psi.

2-4.01.03. Mist Eliminator. One replaceable PVC or polypropylene chevron style mist eliminator shall be provided in each biotrickling filter. The mist eliminator shall have a minimum removal efficiency of 99 percent for entrained liquid droplets having a nominal size larger than 20 microns [20 µm].

2-4.01.04. Connections. All piping connections shall be flanged. Air inlet and outlet connections on each vessel shall conform to ANSI D3982; shall be furnished undrilled; and shall be field drilled to match bolt hole locations on connecting piping. Other flanges for connection to PVC or CPVC piping shall conform to ANSI/ASME B16.1, Class 125 diameter and drilling. The orientation of the piping connections, access openings, and other appurtenances shall be as indicated on the Drawings.

2-4.01.05. Access Openings. Access openings shall be at least 30 inches [750 mm] in diameter and shall permit convenient access to all interior components for inspection, removal, repair, or cleaning. All access opening covers shall be fully gasketed with an elastomeric gasket suitable for the conditions specified, and shall be gastight under the positive internal design operating pressure specified herein. Each opening shall be provided with a transparent PVC or polycarbonate cover held in place by AISI Type 316 stainless steel bolts. Flanges shall conform to ANSI D3982.

2-4.01.06 Ladder, Platform, and Guadrail. An external access ladder with safety cage, access platform, and guardrails shall be provided on biotrickling filters exceeding 10 feet in height. The access platform shall include safety guardrail and toe board around the top of the platform. A self closing safety gate shall be provided at the ladder access opening. The ladder shall be supported on and anchored to the concrete base and bracketed to the vessel shell. The ladder shall be fabricated of aluminum or FRP. No uncoated or exposed carbon steel parts or fastenings will be permitted. The ladder shall have a clear width of at least 16 inches, rungs at least 1 inch in diameter, and spaced not more than 12 inches apart, and shall give a minimum clearance of at least 7 inches between the back of the ladder and the vessel wall. The ladder access platform and

safety guardrails shall be constructed in conformance with OSHA Standard 1910.27.

2-5. ACCESSORIES.

2-5.01. Sumps and Tanks. Biotrickling filter sumps, start-up systems and tanks, recirculation tanks, and nutrient tanks shall be of FRP construction. Arrangement, size, and capacity shall be as recommended by the biotrickling filter manufacturer. Sumps and tanks shall be provided with float valves, drain water outlets, shutoff valves, supply/return water connections, non-potable water supply connections, access covers, and all accessories and valves as required for a complete and properly operating system.

When the system provided requires water supply pressure in excess of the pressure available at the site, a booster pump shall be provided to ensure uniform distribution of scrubbing solution throughout the bed. Irrigation or makeup water will be available at the site as described in the Service Conditions paragraph.

2-5.02. Biotrickling Filter Recycle Tank Blowdown and Level Controls. Each biotrickling filter will be operated with a continuous or time initiated blowdown. The rate and frequency of blowdown shall be as determined by the biotrickling filter manufacturer and shall be controlled by a manual or automatic throttling valve in the makeup water supply line. An overflow outlet with a water trap shall be provided. An overflow pipe shall connect the overflow outlet to the biotrickling filter drain pipe.

A high level and low level control switch shall be provided. In addition, a high-high level device shall be provided to protect the sump from flooding. The Low level switch shall be configured with an alarm and automatically shut down the recirculation pump. The high and high-high levels shall be configured with alarms.

2-5.03 Fans. Fans shall conform to the Odor Control Fans Section.

2-5.04. Recirculation Pumps. Where required for recycle-type systems, recirculation pumps shall be provided. The recirculation pumps shall be horizontal or vertical multistage centrifugal type suitable for continuous operation. The materials of construction of the pumps shall be as recommended by the biotrickling filter manufacturer. Each pump motor shall be suitable for 480 volt, 3 phase, 60 Hz electrical service and shall be provided with a NEMA rated enclosure suitable for the location.

The capacity of pumps shall be as recommended by the biotrickling filter manufacturer. The pump horsepower shown on the schedules is estimated. The biotrickling filter supplier shall be responsible for calculating the final recirculation

pumping unit head loss and adjusting the pump motor horsepower as needed from the horsepower scheduled. The supplier shall bear all costs for adjusting the electrical equipment and power supply as needed to accommodate any motor horsepower adjustment.

2-5.05 Discharge Stacks. Not used.

2-5.06. Piping and Valves. All recirculation piping, irrigation water, drain piping, and blowdown piping shall be SCH 80 PVC or as recommended by the biotrickling filter manufacturer. Valves shall be PVC or as recommended by the biotrickling filter manufacturer.

2-5.07. Differential Pressure Gauges. Differential pressure gauges shall be furnished for monitoring the pressure differential across each media bed and mist eliminator. The gauges shall be permanently mounted and shall be furnished with a mounting bracket, tubing, and all required fittings. Unless otherwise indicated, the installation hardware shall be Type 316L stainless steel. Tubing shall be 1/2 inch PVC pipe, unless otherwise indicated, properly supported and braced for a permanent installation. The gauges shall be installed to allow gravity drainage of condensate in the sensing lines back to the pipe or vessel. Indicators mounted on the biotrickling filter section shall be installed approximately 5 feet above the surrounding floor or concrete slab.

Each gauge shall be of the diaphragm actuated dial type with adjustable pointer, white dial and black figures and markings. Each gauge shall have a range such that under normal operating conditions, the reading is approximately in the middle of the range. Accuracy shall be within 3 percent of full scale. Two shutoff cocks shall be furnished with each gauge.

The gauges shall be furnished with a transparent red overlay extending from the maximum allowable differential pressure reading to the end of the range. Differential pressure gauges shall be Dwyer "Series 4000 Capsuhellic" with diaphragm seal made from a material suitable for exposure to a hydrogen sulfide air stream.

2-5.08. Grounding Rods. Each biotrickling filter vessel shall be equipped with a titanium or hastelloy grounding rod. The grounding rod will provide an earth ground for the biotrickling filter and solution. The grounding rod shall be installed adjacent to the biotrickling filter for connection to the grounding lugs. All electrical provisions shall be provided

2-5.09. Neoprene Pad. A 1/4" [6 mm] thick, 60 durometer neoprene rubber sheet shall be placed underneath the biotrickling filter vessel.

2-5.10. Water Supply. A non-potable water supply pipe sized by the biotrickling filter manufacturer shall be provided to each water control panel. A pressure

reducing valve, pressure gage, and main shutoff ball valve shall be provided on the supply line.

2-5.11. Sump Heaters. Not used.

2-5.12. Heat Tracing. Not used.

2-6. ELECTRICAL. Electrical disconnect switches, motor starters and controls shall be furnished and installed under this section and shall meet the applicable requirements of the Electrical section. The Odor control panel, Biotrickling filter control panel and water cabinet control panel shall have integral starters for motor controls. All electrical controls shall have enclosures suitable for the environment and NEMA rating as indicated on the electrical Drawings for wiring in conduit. Equipment installed outdoors shall have minimum NEMA Type 4X enclosures.

All electrical equipment located within 3 feet of the odor control system malodorous air stream, biotrickling filters, and other leakage sources such as piping, dampers, and fans shall be rated for a NEC Class 1, Division 2, Group D atmosphere in accordance with NFPA 820.

2-6.01. Electric Motors. Motor horsepower scheduled on the Drawings are minimum motor horsepowers. Larger motors shall be provided if required to meet the specified capacities for the equipment furnished. Motors furnished with equipment shall meet the following requirements.

- a. All motor shall be premium efficient motors.
- b. Designed and applied in accordance with NEMA, ANSI, IEEE, AFBMA, and NEC for the duty service imposed by the driven equipment, such as frequent starting, intermittent overload, high inertia, mounting configuration, or service environment.
- c. Rated for continuous duty at 40°C ambient.
- d. Motors used in applications which exceed the usual service conditions as defined by NEMA, such as higher than 40°C ambient, altitude exceeding 3,300 feet, explosive or corrosive environments, departure from rated voltage and frequency, poor ventilation, frequent starting, or adjustable frequency drive applications, shall be properly selected with respect to their service conditions and shall not exceed specified temperature rise limits in accordance with ANSI/NEMA MG 1 for insulation class, service factor, and motor enclosure type.
- e. To ensure long life, motors shall have nameplate horsepower equal or greater than the maximum load imposed by the driven equipment and shall carry a service factor rating as follows:

<u>Motor Size</u>	<u>Enclosure</u>	<u>Service Factor</u>
Fractional hp	Open	1.15
	Other Than Open	1.0
Integral hp	Open	1.15
	Other Than Open	1.0

Motors used with adjustable frequency drives shall have a 1.15 service factor on sine wave power and a 1.0 service factor on drive power.

- f. Designed for full voltage starting.
- g. Designed to operate from an electrical system that may have a maximum of 5 percent voltage distortion according to IEEE 519.
- h. Totally enclosed motors shall have a continuous moisture drain that also excludes insects.
- i. Bearings shall be either oil or grease lubricated.
- j. Motor nameplates shall indicate as a minimum the manufacturer name and model number, motor horsepower, voltage, phase, frequency, speed, full load current, locked rotor current, frame size, service factor, power factor, and efficiency.
- k. Drip-proof motors, or totally enclosed motors at Contractor's option, shall be furnished on equipment in indoor, above-grade, clean, and dry locations.
- l. Totally enclosed motors shall be furnished on:
 - (1) Outdoor equipment.
 - (2) Equipment for installation below grade.
 - (3) Equipment operating in chemical feed and chemical handling locations.
 - (4) Equipment operating in wet or dust-laden locations.
- m. Explosionproof motors shall be provided where located within 3 feet of the odor control system malodorous air stream, biotrickling filters, and other leakage sources such as piping, dampers, and fans; and shall be rated for a NEC Class I, Group D, Division 2 atmosphere in accordance with NFPA 820.
- n. A manufacturer's standard motor may be supplied on packaged equipment and fans in which case a redesign of the unit would be required to furnish motors of other than the manufacturer's standard design. However, in all cases, the motor types indicated are preferred and shall be furnished if offered by the manufacturer as a standard option.

- o. Motors used with adjustable frequency drives shall have insulation system meeting the requirements of NEMA MG 1, Part 31.

2-7. CONTROLS. The control systems shall be furnished and installed as indicated on the Drawings and as specified herein. All controls shall consist of electric equipment.

2-7.01. Control Panels. The control panels shall be installed where indicated on the Drawings, and located in an unclassified area at least 3 feet from any odor control leakage source. Control panels shall be designed for panel stand mounting, and shall be completely prewired and checked. The panel stand shall be constructed of 316 stainless steel.

Control panels shall conform to NEMA ICS 1, NEMA ICS 2, NEMA ICS 3, and NFPA 70. Control panels shall be fiberglass construction and shall be rated NEMA 4X. The control panels shall be supplied with 120 volts, 60 Hz, single phase power, derived from the 480 volts, 60 Hz, 3-phase odor control system supply via a 480:120 volt 1-phase control power transformer, sized as required. All electrical accessory devices and internal electrical wiring shall be furnished and installed. All controllers, motor starters, selector relays, switching relays, interlock relays, manual switches, alarm and indicating lights, and other devices indicated to be panel mounted shall be mounted in or on the respective control panel.

Accessories, such as operator interface, indicating lights and selector switches, shall be mounted on the front hinged covers of the panels. The accessories and panels shall be identified with engraved phenolic nameplates with 1/4 inch high letters. Twenty-five percent extra terminals shall be provided in each control panel.

2-7.01.01. Biotrickling Filter Electrical Control Panel. An electrical control panel shall be provided with each biotrickling filter. Motor starters for pumps and controls shall be furnished, installed, and prewired in the electrical control panel. The devices within the control panel shall be controlled by a PLC or relay based controls located in the control panel. PLC's shall meet the requirements of section 13530. Each electrical control panel shall be furnished with a main power disconnect switch and weather shield. Each electrical control panel shall be furnished with a reset which will enable the system after a loss of power. The electrical control panel shall provide electrical control for the pumps, water and nutrient addition systems. The panel shall have a single point, 480 volt, 3 phase, 60 Hz electrical connection. Transformers shall be provided as necessary for power and control voltages. The panel shall be mounted back-to-back on a common panel stand with the Water Panel, and shall be factory tested to full operation with all other components prior to shipment.

2-7.01.02. Water Panel. A water panel shall be provided with each biotrickling filter to regulate the non-potable water used for start-up and normal moisture control within the biotrickling filter. The devices within the control panel shall be controlled by a PLC or relay based controls located in the control panel. PLC's shall meet the requirements of section 13530. The water panel shall enclose valves, pressure and flow sensors, water measurement equipment, internal heater, thermostat, and a nutrient metering pump. Each water panel heater shall be provided with overload contacts. Each water control panel shall be furnished with a weather shield. The cabinet shall contain all components necessary for a complete and operating system, including the following:

- Nutrient metering pump
- Digital water flow meter
- Nutrient flow sensor
- Recirculation system shutoff valve
- System pressure gauge
- Make-up water shutoff valve
- Make-up water strainer
- Make-up water pressure gauge
- Internal Heater
- Thermostat

2-7.01.03. Odor Control Fan Control Panel. An electrical control panel shall be provided with each odor control fan. Motor starters for the fan, controls and interlocks shall be furnished, installed, and prewired in the electrical control panel. The devices within the control panel shall be controlled by a PLC or relay based controls located in the control panel. PLC's shall meet the requirements of section 13530. Each electrical control panel shall be furnished with a main power disconnect switch and weather shield. Each electrical control panel shall be furnished with a reset which will enable the system after a loss of power. The panel shall have a single point, 480 volt, 3 phase, 60 Hz electrical connection. Transformers shall be provided as necessary for power and control voltages. The panel shall be factory tested to full operation with all other components prior to shipment.

2-7.02. Sump Temperature Switches. Not used.

2-7.03. Selector Switches. Selector switches shall be Micro Switch "Type PT", Cutler-Hammer "10250T Series", or General Electric "CR". Selector switches shall be heavy-duty 30 mm, oiltight type with gloved-hand or wing lever operators. Position legends shall be engraved on switch faceplate. Switches for electric circuits shall have silver butting or sliding contacts, rated 10 amperes continuous at 120 volts ac. Contact configuration shall be as indicated on the Drawings or as necessary for the application. Switches used for electronic signal circuits shall have contacts suitable for that duty.

2-7.04. Indicating Lights. Indicating lights shall be Micro Switch "Type PT", Cutler-Hammer "10250T SeriesT", or General Electric "CR". Indicating lights shall be heavy-duty, 30 mm, push-to-test, oiltight type, with LED lamps. Legends shall be engraved on the lens or on a legend faceplate. Lamps shall be easily replaceable from the front of the indicating light.

2-7.05. Accessory Components. All additional control components, such as electric relays, controllers, and position switches, shall be furnished as needed to ensure a complete, properly operating installation. Accessory components not mounted inside the control panel shall be furnished with equipment enclosures suitable for the environment and NEMA rating as indicated on the electrical Drawings.

2-7.06. Electrical Wiring. Detailed schematic wiring diagrams shall be submitted in accordance with the Submittals Procedures section. The wiring diagrams shall show the internal connections of the control panels and all field wiring to equipment remote from the control panels. The wiring diagrams shall be complete, showing all connections necessary to place the control systems in operation. Conduit and conductors shall meet the applicable requirements of the Electrical Section.

2-7.07. Nameplates. Phenolic nameplates shall be provided and permanently attached to the wall at each control device to indicate the equipment controlled. The letters used shall be the same as the symbols indicated herein and on the Drawings for various equipment. Each nameplate shall have white letters on a black background.

2-9. BALANCE. All rotating parts shall be accurately machined and shall be in as nearly perfect rotational balance as practicable. Excessive vibration shall be sufficient cause for rejection of the equipment. The mass of the unit and its distribution shall be such that the resonance at normal operating speeds is avoided. In any case, the maximum measured root-mean-square (rms) value as measured at any point on the equipment shall not exceed those listed in the latest ASHRAE Applications Handbook.

At any operating speed, the ratio of rotative speed to the critical speed of a unit or components thereof shall be less than 0.8 or more than 1.3.

2-10. SEQUENCE OF OPERATIONS. The sequence of operation for the odor control system shall be as indicated on Drawings.

PART 3 - EXECUTION

3-1. INSPECTION. All equipment and accessories shall be inspected for damage and cleanliness before being installed. Any materials damaged or contaminated in handling on the job shall not be used unless it is repaired and

recleaned to the original requirements by Contractor. Such material shall be segregated from the clean material and shall be inspected and approved by Owner or his representative before its use.

3-2. PREPARATION.

3-2.01. Field Measurement. For new work at existing facilities, Contractor shall field verify the locations of existing piping, structural members, ductwork, equipment, lighting, conduit, ductbank, etc., and locate all new piping, ductwork, equipment, etc. to avoid conflicts with such items.

Equipment installed in existing facilities with limited access shall be suitable for being installed through available openings. Contractor shall field verify existing opening dimensions and other provisions for installation prior to submittal of bids.

3-3. INSTALLATION. Each biotrickling filter unit shall be installed in accordance with the recommendations of the manufacturer. The equipment exterior and the surrounding area shall be cleaned after installation.

Equipment shall be installed on individual concrete bases after initial fitting and alignment, but before final bolting of connecting piping. No stress shall be transmitted to the equipment flanges.

When grouted bases are used, the space beneath baseplates shall be grouted as specified in the Grouting section.

3-3.01. Control Panels. Control panels shall be mounted so that selector switches and indicating lights on the panel are located approximately 4'-6" [1.4 m] above the finished floor.

3-3.02. Differential Pressure Gauges. Differential pressure gauges shall be installed to allow gravity drainage of condensate in the sensing lines back to the pipe or vessel. Indicators mounted on towers shall be installed approximately 4'-6" [1.4 m] above the surrounding floor or concrete slab.

3-4. FIELD QUALITY CONTROL.

3-4.01. Performance Testing. A performance test shall be conducted on the biotrickling filter system to demonstrate that the equipment meets the specified requirements, prior to final acceptance. The performance tests shall not begin until all airflow rates have been adjusted and balanced.

Contractor, with the aid of qualified equipment manufacturers' representatives, shall operate all systems for a minimum of 30 days before performance tests are conducted, or until the biotrickling filter is performing to the satisfaction of the Owner or Engineer. Written documentation indicating the proper operation of all

system components shall be provided to Engineer before the performance test will be allowed.

During the initial 30 day operation, the carbon adsorption bypass damper shall be opened and the carbon adsorption unit inlet damper closed to preserve the life of the carbon. Following the 30 day operation period, the carbon adsorption inlet damper shall be opened and the bypass damper closed.

After completion of the 30 day trial operation, and prior to final acceptance, performance tests shall be conducted on the biotrickling filter system to demonstrate that the equipment meets the specified requirements.

Personnel in charge of the tests shall be competent authorized representatives of the manufacturers who are familiar with operation of the equipment furnished and who have previous experience in conducting similar tests. Qualified personnel shall perform the tests, record the data, make the required calculations, and prepare a report on the results. Testing shall be performed in a manner acceptable to the Engineer. At least four weeks prior to the proposed testing date, Contractor shall notify Engineer of the testing date and shall submit a report for Engineer's acceptance from the odor control system supplier detailing the proposed performance testing procedure and analyses. The proposed test procedure shall be approved by Engineer before testing may proceed.

Contractor shall provide all necessary personnel, materials and equipment for the tests. Prior to the start of the test, Contractor shall operate the systems until the stable biological operating parameters and biotrickling filter controls are established. All fine-tuning of operating conditions shall be performed prior to testing.

The performance tests shall be conducted after installation and initial startup, and after testing and balancing has been completed. The performance test will be conducted under actual loading conditions for each of the systems. Continuous data logging meters (OdaLog meters or similar) will be used to record inlet and outlet H₂S for a period of one week. Two meters are required at each system with the outlet meter having a sensitivity of 0.01 ppm H₂S or less. Logging monitors shall be programmed with a maximum sampling interval of 10 minutes.

As a minimum, at the start and conclusion of each test, Contractor shall record the airflow, irrigation/recirculation rate, makeup water rate, and operating pH.

The performance tests of the biotrickling filter shall establish that an H₂S removal efficiency of 99 percent is maintained under the variable loading conditions that occur over the week long test. For minor short-term excursions a one-hour average will be used to determine compliance. For inlet H₂S concentrations below 10 ppm a maximum outlet H₂S of 0.10 ppm will be acceptable.

In addition to the performance test for H₂S, performance tests shall be performed for overall odor removal. Total odor removal efficiency shall be at least 90 percent, with grab samples taken twice a day at peak and non-peak loading conditions during the week long test period. Grab samples shall be sent to Columbia Analytical Services for testing.

Results of the performance tests shall be provided to Engineer in a written report. The report shall include the raw test data and a graphical plot for each of the tests showing inlet and outlet H₂S. The graph shall also show H₂S removal efficiency over the duration of each test. The report shall also include operating data including airflow, recirculation/irrigation rate, makeup water rate, and operating pH for each system tested.

Five copies of the report shall be submitted to Engineer. The information collected will be used as a basis for determining acceptability of the manufacturer's results. In the case of a conflict, interpretations and calculations made by Engineer will govern.

If the equipment fails to meet the performance requirements, operational adjustments to the system and repeat testing may be allowed at the discretion of the Engineer. Subsequent failure of the equipment to meet the performance and design requirements specified will require equipment modifications to be made by, and at the expense of Contractor. Costs of additional testing and subsequent observation by Engineer will be borne entirely by Contractor.

3-4.02. Applied Pipe Stress Test. After final alignment and bolting, all flanged connections shall be tested for applied piping stresses by loosening the flange bolts. No stresses shall be transmitted to the biotrickling filter flanges. If any movement or opening of the joints is observed, piping shall be adjusted to proper fit.

3-4.03. Installation Check. An experienced, competent, and authorized representative of the manufacturer shall visit the site of the Work and inspect, check, adjust if necessary, and approve the equipment installation. The representative shall be present when the equipment is placed in operation in accordance with the Startup Requirements section, and shall revisit the jobsite as often as necessary until all trouble is corrected and the equipment installation and operation are satisfactory in the opinion of Engineer.

The manufacturer's representative shall furnish a written report certifying that the equipment has been properly installed and lubricated; is in accurate alignment; is free from any undue stress imposed by connecting piping or anchor bolts; and has been operated under full load conditions and that it operated satisfactorily.

All costs for these services shall be included in the Contract Price.

3-5. CLEANING. At the completion of testing, all equipment, pipes, ductwork, valves, and fittings shall be cleaned of grease, debris, metal cuttings, and sludge. Any stoppage, discoloration, or other damage to parts of the building, its finish, or furnishings shall be repaired at no additional cost to Owner.

The inside of all pipe, dampers, and fittings shall be smooth, clean, and free from blisters, sand or dirt when erected. All lines shall be thoroughly purged of air before placing in service.

3-5.01. Fabricated Piping Assemblies. Fabricated piping assemblies shall be cleaned to remove all loose foreign materials such as scale, sand, weld splatter particles, or cutting chips by hand or mechanical cleaning.

3-5.02. Installed Piping. All installed piping shall be cleaned and free from debris and any loose foreign materials, as may be introduced during field installation. Installed piping shall be cleaned by hand or by flushing.

3-6. ADJUST, TEST AND BALANCE.

3-6.01. Adjustments. Contractor shall make all adjustments as directed by the equipment manufacturer.

3-6.02. Testing and Balancing. Testing and balancing for the odor control systems shall conform to the requirements of the Adjusting, and Balancing Odor Control Systems section.

3-7. TRAINING. After completion of the field testing, a minimum eight hour operator instruction and training on equipment and system operation shall be provided. The training should provide a complete overview of all equipment, testing, adjusting, operation, and maintenance procedures. The training shall take the form of classroom instruction and shall cover:

- a. Documentation in the final Operation and Maintenance Manuals.
- b. Use the Operation and Maintenance Manuals.
- c. Equipment and system startup and shutdown.
- d. System operation procedures for all modes of operation.
- e. Procedures for dealing with abnormal conditions and emergency situations for which there is a specified system response.

The training shall take the form of classroom sessions at the project site conducted by the equipment manufacturer representatives who are knowledgeable and familiar with the project. Hands-on instruction and training will be conducted so that actual operation and maintenance of the equipment and systems can be performed by Owner upon completion of the training.

At least two weeks prior to the proposed date for the operator instruction and training session, Contractor shall notify Engineer and shall submit an outline for the proposed operator instruction and training session. The proposed outline shall be approved before any training is conducted.

End of Section

Section 11356

ODOR CONTROL FANS

PART 1 - GENERAL

1-1. SCOPE. This section covers the furnishing and installation of centrifugal fans complete with electric drive motor, base, and accessories as specified herein.

Piping, pipe supports, valves, and accessories which are not an integral part of the equipment or are not specified herein are covered in other sections.

1-2. GENERAL. Equipment furnished and installed under this section shall be fabricated, assembled, erected, and placed in proper operating condition in full conformity with the drawings, specifications, engineering data, instructions, and recommendations of the equipment manufacturer unless exceptions are noted by Engineer.

1-2.01. Coordination. Contractor shall verify that equipment furnished under this section is coordinated with other components of the applicable odor control system.

Where two or more units of the same class of equipment are required, they shall be the product of a single manufacturer; however, all the component parts of the system need not be the products of one manufacturer.

Each manufacturer of major equipment shall have a local service center, or with written consent of Engineer, shall be able to provide service from other locations within 24 hours. The service center shall be equipped and staffed to service the system and shall maintain a local parts supply. Information on equipment manufacturers' representatives shall be included with the submittals.

Where several manufacturers' names have been listed in this section as possible suppliers, only the products of the first manufacturer listed have been checked for size, functions, and features.

1-2.02. General Equipment Stipulations. The General Equipment Stipulations shall apply to all equipment and materials furnished under this section. If requirements in this specification differ from those in the General Equipment Stipulations, the requirements specified herein shall take precedence.

1-2.03. Governing Standards. Except as modified or supplemented herein, all work covered by this section shall be performed in accordance with all applicable

municipal codes and ordinances, laws, and regulations. In case of a conflict between this section and any state law or local ordinance, the latter shall govern.

All work shall comply with Underwriters' Laboratories (UL) safety requirements.

1-2.04. Power Supply. Power supply to equipment with motors shall be as indicated in the schedules on the Drawings. Power supply for controls shall be 120 volts, 60 Hz, single phase unless otherwise required for a properly operating system.

1-2.05. Metal Thickness. Metal thickness and gages specified herein are minimum requirements. Gages refer to US Standard gage.

1-2.06. Mechanical Identification. Fans and control equipment shall be identified in accordance with Equipment and Valve Identification section.

1-3. SUBMITTALS.

1-3.01. Drawings and Data. Complete fabrication, assembly, and installation drawings, wiring and schematic diagrams, together with detailed specifications and data covering materials, parts, devices, and accessories forming a part of the equipment furnished, shall be submitted in accordance with the Submittals Procedures section. Device tag numbers indicated on the Drawings shall be referenced on the wiring and schematic diagrams where applicable. The data and specifications for each unit shall include, but shall not be limited to, the following:

Fans

- Name of manufacturer.
- Type and model.
- Rotative speed (design and maximum safe operating speed).
- Bearing type and lubrication.
- Connection sizes.
- Net weight.
- Overall dimensions.
- Anchor bolt details.
- All material types, thicknesses, and finishes.
- Resin type and chemical resistance.
- Performance curves for each fan with capacity in cubic feet per minute as the abscissa, and brake horsepower, static pressure, and fan efficiency as the ordinate. The fan curves shall include a family of curves for a minimum of 3 different rotative speeds.
- Sound power output data for the fan housing and ducted outlet when operating at the specified volume flow rate. Sound data shall list dB re 10^{-12} watts in each octave band, with midrange frequencies starting at 63 Hz and ending at 8,000 Hz; and dBA at 5 feet [1.5 m].

Motors

- Name and manufacturer.
- Type and model.
- Bearing type and method of lubrication.
- Rated size of motor, hp, and service factor.
- Temperature rise and insulation rating.
- Full load rotative speed.
- Net weight.
- Efficiency at full, $\frac{3}{4}$, and $\frac{1}{2}$ loads.
- Full load current.
- Overall dimensions.
- Space heater wattage.

Flexible Connections and Transition Pieces

- Name of manufacturer.
- Materials of construction.
- Pressure and vacuum rating.
- Dimensions.

Inlet Boxes

- Materials of construction.
- Dimensions.
- Pressure loss performance ratings.

Acoustical Enclosures

- Name of manufacturer.
- Materials of construction.
- Dimensions.
- Accessories.

1-3.02. Operation and Maintenance Data and Manuals. Adequate operation and maintenance information shall be submitted in accordance with the Submittals Procedures section. Equipment designations used shall correspond to those indicated on the Drawings. The operation and maintenance manuals shall be in addition to any instructions or parts lists packed with or attached to the equipment when delivered.

1-3.03. Color Selection. Colors for factory finish of the fans shall be selected by Engineer from the manufacturer's full range of standard and custom colors. Samples shall be submitted for color selection in accordance with the Submittals Procedures sections.

1-4. QUALITY ASSURANCE.

1-4.01. Welding Qualifications. All welding procedures and welding operators shall be qualified by an independent testing laboratory in accordance with the applicable provisions of AWS Standard Qualification Procedures. All procedure and operator qualifications shall be in written form and subject to Engineer's review. Accurate records of operator and procedure qualifications shall be maintained by Contractor and made available to Engineer upon request.

1-4.02. Manufacturer Experience. Unless specifically named in the Specifications, a manufacturer shall have furnished equipment of the type and size specified which has been in successful operation for not less than the past 10 years, and shall provide a reference list with the names, addresses, and contact phone numbers for a minimum of 20 similar installations.

1-4.03. Fan Performance. Each fan shall bear the AMCA 211 Certified Rating Seal for fan performance or be tested in accordance with AMCA Standard 210 in an AMCA accredited lab to confirm fan performance.

1-4.04. Fan Sound Rating. Each fan shall bear the AMCA 311 Certified Rating Sound Seal for fan sound performance or be tested in accordance with AMCA Standard 300 and 301 in an AMCA accredited lab to confirm sound performance..

The sound pressure level outside the fan shall meet the requirements indicated in the Fan Schedule on the Drawings.

1-5. DELIVERY, STORAGE, AND HANDLING. Shipping shall be in accordance with the Product Delivery Requirements section. Handling and storage shall be in accordance with the Product Storage and Handling Requirements section.

1-6. EXTRA MATERIALS. Extra materials shall be furnished for the equipment as follows:

<u>Extra Materials</u>	<u>Quantity</u>
Fan V-belts	1

Extra materials shall be packaged in accordance with the Shipping section, with labels indicating the contents of each package. Each label shall indicate manufacturer's name, equipment name, part nomenclature, part number, address of nearest distributor, and current list price. Extra materials shall be delivered to Owner as directed.

Extra materials subject to deterioration such as ferrous metal items and electrical components shall be properly protected by lubricants or desiccants and encapsulated in hermetically sealed plastic wrapping.

PART 2 - PRODUCTS

2-1. SERVICE CONDITIONS. All equipment shall be designed and selected to meet the specified conditions. The fans shall be suitable for the following service conditions and designed for continuous 24 hour per day operation:

Ambient temperature range.	0 to 120 °F
Environmental exposure.	Outdoor
Site elevation.	12 ft

2-2. PERFORMANCE AND DESIGN REQUIREMENTS. All fan components of plastic construction shall contain ultraviolet inhibitors. Each fan shall be designed for the conditions indicated in the schedules on the Drawings.

Each fan's operating selection point on the fan curves shall be selected to the right of the peak pressure/efficiency point and below the lowest point along the fan curve to the left of the peak pressure/efficiency point. The fan design rotative speed shall not be greater than 90 percent of the fan wheel maximum rotative speed.

2-2.01. Dimensional Restrictions. Layout dimensions will vary between manufacturers and the layout area indicated on the Drawings is based on typical values of the first manufacturer listed. Contractor shall review the contract Drawings, the manufacturer's layout drawings, and installation requirements and shall make any modifications required for proper installation subject to acceptance by Engineer. At least 3 feet [0.9 m] of clear access space shall be provided on all sides of the unit unless otherwise indicated.

2-2.02. Elevation. Equipment shall be designed to operate at an elevation of 12 feet above sea level.

2-3. ACCEPTABLE MANUFACTURERS. The fan manufacturer shall be licensed to display the logo of an AMCA member company. Fans of FRP construction shall be as manufactured by New York Blower, Twin Cities Fan & Blower, or Hartzell.

2-4. MANUFACTURE AND FABRICATION.

2-4.01. Surface Preparation. All iron and steel surfaces, except motors and speed reducers, shall be shop cleaned by sandblasting or equivalent, in strict conformance with the paint manufacturer's recommendations. All mill scale, rust, and contaminants shall be removed before shop primer is applied.

2-5. CONSTRUCTION.

2-5.01. Unitary Base. Each fan, inlet elbow, and drive shall be mounted on a common unitary base provided by the fan manufacturer. The base shall have rounded corners, and all exposed seams and contact surfaces of steel plates and shapes shall be continuously welded and ground smooth. Each base shall be arranged to permit drive belt tension adjustment. An opening shall also be provided, if necessary, for electrical conduit to the drive unit.

2-5.02. Fan. The fans shall be single-width, single-inlet type with blade construction type as indicated in the schedules on the Drawings. Each fan shall be designed for the rotation and discharge direction indicated on the Drawings.

Fiberglass reinforced plastic (FRP) fans shall have housings and fan wheel constructed of FRP. The fan housing and wheel shall be made of chemical grade vinyl ester resin. Except as modified or supplemented herein, the fan shall comply with the applicable provisions of ASTM D4167. The fan shall be suitable for operation with temperatures up to 150°F [66°C] without derating the safe operating speed of the fan. The entire housing and airstream surfaces shall be graphite impregnated and grounded to prohibit static buildup. The fan shall have an ASTM E-84 Class I flame spread rating. Fan housings and supports shall contain an ultraviolet inhibitor or coating. Lift and hold-down lugs shall be integrally molded into the fabrications. Housings shall have a plugged drain connection at the low point of the scroll and a gasketed access door. The fan shaft shall be completely encapsulated in an FRP sleeve where exposed to the airstream. A Viton shaft seal shall be furnished. All hardware exposed to the airstream shall be 316 stainless steel, embedded in FRP.

The supporting frame shall be of welded carbon steel or fiberglass reinforced plastic construction. All exterior and exposed metal surfaces of the support frames shall be sandblasted, primed, and shop coated with epoxy to a minimum dry film thickness of 10 mils [250 µm].

Bearings shall be self-aligning, antifriction type with external grease fittings and shall have an AFBMA L₁₀ Life Rating of 100,000 hours at specified operating conditions.

Each fan wheel and shaft shall be statically and dynamically balanced at the factory before shipment. The first critical speed of the rotating assembly shall be not less than 125 percent of the maximum recommended operating speed. Each fan shall be provided with shaft seals.

The fan inlet shall be straight or flanged. The fan discharge shall be flanged. Flanges shall be the fan manufacturer's standard dimensions and drilling.

2-6. ACCESSORIES.

2-6.01. Transitions. Fiberglass reinforced plastic transition pieces shall be furnished with each fan. Each transition shall be flanged on the fan end and shall adapt the flanged inlet/outlet connection of each fan to the flexible connector. Transition pieces shall have a minimum wall thickness of 1/4 inch [6 mm] and an outside diameter equal to that of the connecting fiberglass reinforced plastic pipe. Flanges shall have a thickness of at least 3/8 inch [9 mm]. Flange bolt holes shall be field drilled to match the applicable fan connection.

2-6.02. Weather Cover. Not used.

2-6.03. Vibration Isolators. Vibration isolators shall be provided as required. Isolators shall be restrained spring vibration isolators. Isolators shall be constructed of corrosion-resistant materials and shall be suitable for outdoor installation. Vibration isolators shall have neoprene acoustical frictional pads, leveling bolts, and provisions for bolting to support frame. Springs shall be designed with a horizontal stiffness at least 75 percent of the vertical stiffness, 50 percent travel beyond rated loads and safe solid stresses.

2-6.04. Pressure Differential Switches. Not used.

2-6.05. Vibration Switches. Not used.

2-6.06. Differential Pressure Gauges. Not used.

2-6.07. Fan Inlet Boxes. Fan inlet boxes shall be provided by the fan manufacturer where indicated on the Drawings. Inlet boxes shall be made of either all fiberglass reinforced plastic construction with corrosion resistant vinyl ester resin or Type 316 stainless steel with coating to match the associated fan. Inlet box components shall be bolted together, and the box shall be bolted to the fan inlet with all stainless steel hardware. A stainless steel support leg assembly shall be provided and the fan base shall be extended to meet the support leg assembly.

2-6.08. Acoustical Enclosures. Acoustical enclosures shall be provided by the fan manufacturer where indicated on the Drawings. Acoustical enclosures shall be made of all fiberglass reinforced plastic construction with acoustical treatments. Enclosures shall come with access doors, and acoustical ventilating louvers sized for adequate cooling of the enclosed fan and motor. Enclosures shall provide full access to all fan components. Enclosures shall come with factory applied, gel coat, ultraviolet resistant finish coat. Enclosures shall reduce sound pressure levels a minimum of 10 dBA at a distance of three feet. All fastening and mounting hardware shall be stainless steel. Acoustic enclosures shall be as manufactured by Soundguard or equal.

2-6.09. Flexible Connections. Flexible connections in odor control gas piping shall be installed at the locations indicated on the Drawings and at other locations for proper installation as determined by the odor control systems supplier.

Flexible connections shall be fully molded type rated for a minimum 3 psi [21 kPa] working pressure and shall consist of an inner tube, body, and outer cover to be compatible with the specified service conditions. The tube shall be a minimum of 1/4 inch [6 mm] thick EPDM with two ply of high tensile nylon, polyester, or kevlar fabric reinforcement. The cover shall be a minimum 1/16-inch [1.5 mm] elastomer and shall be resistant to ultraviolet light.

Slip on type flexible connections shall fit tightly on the outside diameter of the piping and shall be secured in place by stainless steel adjustable bands with worm screw type adjustments to provide a gastight connection.

Flanged type flexible connections shall have split stainless steel retaining rings and shall have ASTM D3982 diameter and drilling. Flexible connections shall be Red Valve "Duct Expansion Joints", Mercer Rubber Company, or Holz Rubber Company.

2-7. ELECTRICAL. Motor starters and controls for the odor control fan shall be furnished and installed as specified in specification 11355. Disconnects for equipment shall be furnished and installed under the Electrical section, except where specified with integral disconnects. All electrical controls shall have enclosures suitable for the environment and NEMA rating as indicated on the electrical Drawings for wiring in conduit. Equipment installed outdoors shall have NEMA Type 4 enclosures. Prewired electric motors installed in packaged equipment are not required to have clamp type grounding terminals in the conduit box or oversized conduit boxes.

2-8. DRIVE UNITS.

2-8.01. Adjustable Frequency Drives. Not used.

2-8.02. V-Belt Drives. Each V-belt drive shall include a sliding base or other suitable belt tension adjustment. V-belt drives shall have a service factor of at least 1.5 at maximum speed based on the nameplate horsepower [kW] of the drive motor. Multiple belts shall be provided in matched sets and shall be oil resistant, non-static type. External belts and drive assemblies shall be protected by a belt safety guard constructed in accordance with OSHA requirements. The guard shall be provided with a tachometer opening.

Unless otherwise indicated in the specific equipment paragraph, equipment with smaller than 10 horsepower [7.5 kW] motors shall have adjustable pitch sheaves and equipment with 10 horsepower [7.5 kW] and larger motors shall have fixed

sheaves. Adjustable sheaves shall be selected so that the fan speed at the specified conditions is selected at the mid-position of the sheave range. Fixed sheaves shall be replaced as necessary with sheaves of the proper size during the air system balancing to provide the required speed for the specified airflow.

2-8.03. Electric Motors. Motor horsepower scheduled on the Drawings are minimum motor horsepower. Larger motors shall be provided if required to meet the specified capacities for the equipment furnished. Motors shall be rated for installation in a NEC Class 1, Division 2, Group D environment.

- a. All motor shall be premium efficient motors.
- b. Designed and applied in accordance with NEMA, ANSI, IEEE, AFBMA, and NEC for the duty service imposed by the driven equipment, such as frequent starting, intermittent overload, high inertia, mounting configuration, or service environment.
- c. Rated for continuous duty at 40°C ambient.
- d. Motors used in applications which exceed the usual service conditions as defined by NEMA, such as higher than 40°C ambient, altitude exceeding 3,300 feet [1005 m], explosive or corrosive environments, departure from rated voltage and frequency, poor ventilation, frequent starting, or adjustable frequency drive applications, shall be properly selected with respect to their service conditions and shall not exceed specified temperature rise limits in accordance with ANSI/NEMA MG 1 for insulation class, service factor, and motor enclosure type.
- e. To ensure long life, motors shall have nameplate horsepower [kW] equal or greater than the maximum load imposed by the driven equipment and shall carry a service factor rating as follows:

<u>Motor Size</u>	<u>Enclosure</u>	<u>Service Factor</u>
Fractional hp [kW]	Open	1.15
	Other Than Open	1.0
Integral hp [kW]	Open	1.15
	Other Than Open	1.0

Motors used with adjustable frequency drives shall have a 1.15 service factor on sine wave power and a 1.0 service factor on drive power.

- f. Designed for full voltage starting.
- g. Designed to operate from an electrical system that may have a maximum of 5 percent voltage distortion according to IEEE 519.
- h. Totally enclosed motors shall have a continuous moisture drain that also excludes insects.

- i. Bearings shall be either oil or grease lubricated.
- j. Motor nameplates shall indicate as a minimum the manufacturer name and model number, motor horsepower, voltage, phase, frequency, speed, full load current, locked rotor current, frame size, service factor, power factor, and efficiency.
- k. Dripproof motors, or totally enclosed motors at Contractor's option, shall be furnished on equipment in indoor, above-grade, clean, and dry locations.
- l. Totally enclosed motors shall be furnished on:
 - (1) Outdoor equipment.
 - (2) Equipment for installation below grade.
 - (3) Equipment operating in chemical feed and chemical handling locations.
 - (4) Equipment operating in wet or dust-laden locations.
- m. Explosionproof motors shall be provided where located within 3 feet of the odor control system malodorous air stream, biotrickling filters, and other leakage sources such as piping, dampers, and fans; and shall be rated for a NEC Class I, Group D, Division 2 atmosphere in accordance with NFPA 820.
- n. A manufacturer's standard motor may be supplied on packaged equipment and fans in which case a redesign of the unit would be required to furnish motors of other than the manufacturer's standard design. However, in all cases, the motor types indicated are preferred and shall be furnished if offered by the manufacturer as a standard option.
- o. Motors used with adjustable frequency drives shall have insulation system meeting the requirements of NEMA MG 1, Part 31.

2-9. BALANCE. All rotating parts shall be accurately machined and shall be in as nearly perfect rotational balance as practicable. Excessive vibration shall be sufficient cause for rejection of the equipment. The mass of the unit and its distribution shall be such that the resonance at normal operating speeds is avoided. In any case, the maximum measured root-mean-square (rms) value as measured at any point on the equipment shall not exceed those listed in the latest ASHRAE Applications Handbook.

At any operating speed, the ratio of rotative speed to the critical speed of a unit or components thereof shall be less than 0.8 or more than 1.3.

PART 3 - EXECUTION

3-1. INSPECTION. All equipment and accessories shall be inspected for damage and cleanliness before being installed. Any material damaged or contaminated in handling on the job shall not be used unless it is repaired and recleaned to the original requirements by Contractor. Such material shall be segregated from the clean material and shall be inspected and approved by Owner or his representative before its use.

3-2. PREPARATION.

3-2.01. Field Measurement. For new work at existing facilities, Contractor shall field verify the locations of existing piping, structural members, ductwork, equipment, lighting, conduit, etc., and locate all new piping, ductwork, and equipment to avoid conflicts with such items. Equipment installed in existing facilities with limited access shall be suitable for being installed through available openings. Contractor shall field verify existing opening dimensions and other provisions for installation prior to submittal of bids.

3-3. INSTALLATION. Each fan shall be leveled, aligned, and positioned to fit connecting piping. Installation procedures for fans and accessories shall be as recommended by the equipment manufacturers. Prior to being placed in operation, each fan shall be inspected by a representative of the manufacturer.

3-4. FIELD QUALITY CONTROL.

3-4.01. Installation Check. An experienced, competent, and authorized representative of the manufacturer shall visit the site of the Work and inspect, check, adjust if necessary, and approve the equipment installation. The representative shall be present when the equipment is placed in operation in accordance with the Startup Requirements section, and shall revisit the jobsite as often as necessary until all trouble is corrected and the equipment installation and operation are satisfactory in the opinion of Engineer.

The manufacturer's representative shall furnish a written report certifying that the equipment has been properly installed and lubricated; is in accurate alignment; is free from any undue stress imposed by connecting piping or anchor bolts; and has been operated under full load conditions and that it operated satisfactorily.

All costs for these services shall be included in the Contract Price.

3-4.02. Field Testing. After the installation of the equipment and systems has been completed, tests shall be conducted to demonstrate that each system is functioning as specified and to the satisfaction of Engineer.

If inspection or tests indicate defects, the defective work or material shall be replaced, and inspection and tests repeated. All repairs to piping shall be made with new materials. Caulking of threaded joints or holes will not be acceptable.

3-5. ADJUSTING. Contractor shall make all adjustments to the fan or accessory items as directed by the equipment manufacturer.

3-6. CLEANING. At the completion of testing, all equipment, pipes, ductwork, valves, and fittings shall be cleaned of grease, debris, metal cuttings, and sludge. Any stoppage, discoloration, or other damage to parts of the building, its finish, or furnishings shall be repaired at no additional cost to Owner.

End of Section

Section 11357

ODOR CONTROL DAMPERS

PART 1 - GENERAL

1-1. SCOPE. This section covers the furnishing and installation of air dampers for odor control systems.

Piping, pipe supports, valves, and accessories which are not an integral part of the equipment or are not specified herein are covered in other sections.

1-2. GENERAL. Equipment furnished and installed under this section shall be fabricated, assembled, erected, and placed in proper operating condition in full conformity with the drawings, specifications, engineering data, instructions, and recommendations of the equipment manufacturer unless exceptions are noted by Engineer.

1-2.01. Coordination. Equipment furnished under this section shall be coordinated with other components of the applicable odor control system.

Where two or more units of the same class of equipment are required, they shall be the product of a single manufacturer; however, all the component parts of the system need not be the products of one manufacturer.

1-2.02. General Equipment Stipulations. The General Equipment Stipulations shall apply to all equipment and materials furnished under this section. If requirements in this specification differ from those in the General Equipment Stipulations, the requirements specified herein shall take precedence.

1-2.03. Governing Standards. Except as modified or supplemented herein, all work covered by this section shall be performed in accordance with all applicable municipal codes and ordinances, laws, and regulations. In case of a conflict between this section and any state law or local ordinance, the latter shall govern.

All work shall comply with Underwriters' Laboratories (UL) safety requirements.

1-2.04. Power Supply. Power supply to equipment with motors shall be as indicated in the schedules on the drawings. Power supply for controls shall be 120 volts, 60 Hz, single phase unless otherwise required for a properly operating system.

1-2.05. Metal Thickness. Metal thickness and gages specified herein are minimum requirements. Gages refer to US Standard gage.

1-2.06 Mechanical Identification. Dampers shall be identified in accordance with the Equipment and Valve Identification section. Damper color coding shall be as specified in the Protective Coatings section and match adjacent piping.

1-3. SUBMITTALS.

1-3.01. Drawings and Data. Complete fabrication, assembly, and installation drawings, wiring and schematic diagrams, together with detailed specifications and data covering materials, parts, devices, and accessories forming a part of the equipment furnished, shall be submitted in accordance with the Submittals Procedures section. Device tag numbers indicated on the drawings shall be referenced on the wiring and schematic diagrams where applicable. The data and specifications for each unit shall include, but shall not be limited to, the following:

Odor Control Dampers

- Name of manufacturer.
- Type and model.
- Materials of construction.
- Pressure rating.
- Vacuum rating.
- Leakage and performance data.
- Overall dimensions.
- Flange dimensions and drilling.
- Total weight, including actuator.
- Required operating and break away torque.

1-3.02. Operation and Maintenance Data and Manuals. Operation and maintenance information shall be supplied as required in the Submittals Procedures section. Equipment designations used shall correspond to those indicated on the Drawings. The operation and maintenance manuals shall be in addition to any instructions or parts lists packed with or attached to the equipment when delivered.

1-4. QUALITY ASSURANCE.

1-4.01. Manufacturer Experience. Unless specifically named in the Specifications, a manufacturer shall have furnished equipment of the type and size specified which has been in successful operation for not less than the past 5 years, and shall provide a reference list with the names, addresses, and contact phone numbers for a minimum of 20 similar installations.

1-5. DELIVERY, STORAGE, AND HANDLING. Shipping shall be in accordance with the Product Delivery Requirements section. Handling and storage shall be in accordance with the Product Storage and Handling Requirements section.

PART 2 - PRODUCTS

2-1. PERFORMANCE AND DESIGN REQUIREMENTS. All equipment shall be designed and selected to meet the specified conditions. The dampers will be used in malodorous air fully saturated with water vapor and will contain hydrogen sulfide and other non- H₂S compounds (including but not limited to ammonia, reduced sulfides such as methyl mercaptan and dimethyl sulfide, and other volatile organic compounds).

2-1.01. Dimensional Restrictions. Layout dimensions will vary between manufacturers and the layout area indicated on the drawings is based on typical values. Contractor shall review the contract drawings, the manufacturer's layout drawings, and installation requirements and shall make any modifications required for proper installation subject to acceptance by Engineer.

2-2. ACCEPTABLE MANUFACTURERS. Acceptable manufacturers shall be as listed in the respective product description paragraphs.

2-3. MANUFACTURE AND FABRICATION.

2-3.01. Odor Control Dampers. Dampers shall be of the single blade type complete with channel type frame, close fitting blade, full length axle, and bearings. Dampers shall have a maximum air leakage rate of 3 cfm [0.001 m³/s] per square foot at a pressure or vacuum of 10 inches of water column [2.4 kPa]. Dampers used for shutoff and isolation shall be furnished with a blade seal and shaft seal. Dampers used for balancing shall be furnished with a blade stop and shaft seal. Each damper shall have the same inside dimensions as the connecting piping. Axles shall be continuous through the damper. Dampers shall be Swartwout "914", Belco, Daniel Company, or Viron.

Frame	Vinyl Ester
Blade	Vinyl Ester
Blade Seal	EPDM.
Shaft Seal	Viton.
Flanges	Flanges shall comply with ASTM D3982.

2-3.02. Backdraft Dampers. Not used.

2-3.03. Actuators and Accessories. Damper actuators and accessories shall be furnished and installed as indicated. All required linkages and accessories required for a complete installation shall be furnished.

2-3.03.01. Hand Actuators. Each hand, crank lever actuator shall be all Type 316 stainless steel construction and shall have a locking quadrant suitable for positioning the blade at the fully open, the fully closed or any intermediate position. Dampers 24 inches and larger shall be provided with epoxy coated worm gear operator with hand crank.

2-3.03.02. Chainwheel Actuators. Chainwheel actuators shall be installed for each damper installed at an elevation greater than 8 feet [2.4 m] above the floor. Each chainwheel-operated damper shall be equipped with a chain guide which will permit rapid handling of the operating chain without "gagging" of the wheel and will also permit reasonable side pull on the chain. Suitable extensions shall be provided, if necessary, to prevent interference of the chain with adjacent piping or equipment. Operating chains shall be hot-dip galvanized carbon steel and shall be looped to extend to within 4 feet [1.2 m] of the floor or operating platform.

2-3.03.03. Electric Actuators. Not used.

2-3.03.04. Position Indicator Switch. Not used.

PART 3 - EXECUTION

3-1. INSPECTION. All equipment and accessories shall be inspected for damage and cleanliness before being installed. Any material damaged or contaminated in handling on the job shall not be used unless it is repaired and recleaned to the original requirements by Contractor. Such material shall be segregated from the clean material and shall be inspected and approved by Owner or his representative before its use.

3-2. PREPARATION.

3-2.01. Field Measurement. For new work at existing facilities, Contractor shall field verify the locations of existing piping, structural members, ductwork, equipment, lighting, conduit, etc., and locate all new piping, ductwork, and equipment to avoid conflicts with such items.

Equipment installed in existing facilities with limited access shall be suitable for being installed through available openings. Contractor shall field verify existing opening dimensions and other provisions for installation prior to submittal of bids.

3-3. INSTALLATION. The dampers shall be positioned to fit in the connecting piping. Unless otherwise necessary for proper operation of the damper, the axles shall be installed in the horizontal position. The inside of the dampers shall be smooth, clean, and free from blisters and dirt when installed.

3-4. FIELD QUALITY CONTROL.

3-4.01. Field Testing. After the installation of the equipment and systems has been completed, tests shall be conducted to demonstrate that each system is functioning as specified and to the satisfaction of Engineer.

If inspection or tests indicate defects, the defective work or material shall be replaced, and inspection and tests repeated. All repairs to piping shall be made with new materials. Caulking of threaded joints or holes will not be acceptable

3-5. CLEANING. At the completion of testing, all equipment, pipes, ductwork, valves, and fittings shall be cleaned of grease, debris, metal cuttings, and sludge. Any stoppage, discoloration, or other damage to parts of the building, its finish, or furnishings shall be repaired at no additional cost to Owner.

End of Section

THIS PAGE LEFT BLANK INTENTIONALLY

Section 11390

ADJUSTING AND BALANCING ODOR CONTROL SYSTEMS

PART 1 - GENERAL

1-1. SCOPE. This section covers the cleaning, testing, adjusting, and balancing of the air system(s) associated with the odor control system(s).

1-2. GENERAL. Equipment and systems shall be cleaned, tested, adjusted, and balanced in full conformity with the drawings, specifications, engineering data, instructions, and recommendations of the equipment manufacturer unless exceptions are noted by Engineer.

1-2.01. Coordination. Contractor shall verify that all components and devices necessary for a properly functioning system have been provided. Prior to cleaning, testing, adjusting, and balancing, Contractor shall verify that each system has been installed properly and is operating as specified. Equipment bearings shall be lubricated in accordance with the manufacturer's recommendations.

Air systems shall be complete and operating, with dampers, filters, ductwork, air outlet and inlet devices, duct mounted equipment, and control components.

1-2.02. Governing Standards. Except as modified or supplemented herein, all work covered by this section shall be performed in accordance with all applicable municipal codes and ordinances, laws, and regulations. In case of a conflict between this section and any state law or local ordinance, the latter shall govern.

All work shall comply with the latest edition of AABC, NEBB, or SMACNA standard manuals for testing, adjusting, and balancing of air systems.

1-3. SUBMITTALS.

1-3.01. Drawings and Data. Complete apparatus report sheets for all air systems shall be accurately and completely filled out in accordance with the Standard's manual. Copies of the final test readings and report sheets shall be submitted in accordance with the Submittals Procedures section. The submittal shall include a reduced set of drawings, with the air outlet devices, air inlet devices, and equipment identified to correspond with the report sheets.

The apparatus report sheets shall include the following information:

1. Title Page:
 - a. Company name

- b. Company address
 - c. Company telephone number
 - d. Project name
 - e. Project location
 - f. Project Engineer
 - g. Project Contractor
 - h. Project altitude
 - i. Date
2. Instrument List:
- a. Instrument
 - b. Manufacturer
 - c. Model
 - d. Serial number
 - e. Range
 - f. Calibration date
3. Air Moving Equipment:
- a. Unit number
 - b. Location
 - c. Manufacturer
 - d. Model and serial number
 - e. Airflow, design and actual
 - f. Total static pressure (total external), design and actual
 - g. Static pressure, inlet and discharge
 - h. Total pressure
 - i. Fan RPM, design and actual
4. Electric Motors:
- a. Manufacturer
 - b. Motor type and frame
 - c. HP/BHP
 - d. Phase, voltage, amperage, nameplate, actual, no load.
 - e. RPM
 - f. Service factor
 - g. Starter size, rating, heater elements
5. V-Belt Drive:
- a. Required driven RPM
 - b. Driven sheave make, diameter, and RPM
 - c. Belt make, size, and quantity
 - d. Motor sheave make, diameter, and RPM
 - e. Center to center distance, maximum, minimum, and actual
6. Outlet and Inlet:
- a. Air outlet and inlet sizes
 - b. Location
 - c. Velocity, design, preliminary, and final
 - d. Air flow, design, preliminary, and final
 - e. Percent of design airflow

1-4. QUALITY ASSURANCE. Contractor shall provide the services of a licensed independent contractor, certified by AABC, NEBB, or TABB and with proven experience on at least three similar projects, to perform operational testing, adjusting, and balancing of the air systems. The work shall be performed in accordance with the latest edition of the procedural standards as published by the National Organization associated with the testing, adjusting, and balancing contractor.

PART 2 - PRODUCTS

2-1. SERVICE CONDITIONS. All equipment shall be adjusted or balanced to meet the specified conditions and to operate at the elevation indicated in the equipment sections.

2-2. CONSTRUCTION.

2-2.01. Painting. Surface finish damaged during cleaning, testing, adjusting, and balancing of equipment shall be repaired to the satisfaction of Engineer.

PART 3 - EXECUTION

3-1. INSPECTION. Before testing and balancing the air system, fans shall be checked for correct rotation and rotative speed. Dampers shall be open and access doors and panels shall be closed during the testing and balancing period.

3-2. STARTUP REQUIREMENTS. System equipment shall be subject to preliminary field tests as indicated in Startup Requirements section.

3-3. FIELD PERFORMANCE TESTING. Field performance tests shall be conducted for each system to demonstrate each is functioning as specified and to the satisfaction of Engineer. All tests shall be conducted in a manner acceptable to Engineer and shall be repeated as many times as necessary to secure Engineer's acceptance of each system. If inspection or tests indicate defects, the defective item or material shall be replaced, and the inspection and tests shall be repeated. All repairs to piping shall be made with new materials. Caulking of threaded joints or holes will not be acceptable.

3-3.01. Hydronic Piping. Not used.

3-3.02. Refrigerant Piping. Not used.

3-4. CLEANING. At the completion of the testing, all parts of the installation shall be thoroughly cleaned. All equipment, ductwork, pipes, valves, and fittings shall be cleaned of grease, debris, metal cuttings, and sludge. Any stoppage,

discoloration, or other damage to parts of the building, its finish, or furnishings shall be repaired by Contractor at no additional cost to Owner.

3-4.01. Chemical Pipe Cleaning. Not used.

3-5. ADJUSTING & BALANCING. The air system shall be adjusted and balanced.

All instrumentation shall be calibrated in accordance with the governing standard manual and shall be checked for accuracy before testing, adjusting, and balancing the systems. The accuracy of the instrumentation shall be not less than specified by the testing, adjusting, and balancing standard manual or the instrument manufacturer.

All data, including system deficiencies encountered and corrective measures taken, shall be recorded. If a system cannot be adjusted to meet the design requirements, Contractor shall notify Engineer in writing as soon as practicable.

Following final acceptance of the certified balancing reports, the testing and balancing contractor shall permanently mark the settings of all adjustment devices, including valves and dampers, and shall lock the memory stops.

All ceiling tiles, belt guards, panels, and doors removed during testing, adjusting, and balancing shall be reinstalled.

3-5.01. Air Systems. Air systems shall be adjusted to the design airflows indicated on the Drawings. Airflows shall be adjusted to maintain a net positive (supply airflow greater than exhaust airflow) or negative (exhaust airflow greater than supply airflow) pressure as indicated on the Drawings. Dampers located behind air outlet and inlet devices shall be used to adjust the airflow only to the extent that the adjustments do not create objectionable air movement or noise.

Dampers with operators shall be checked for tight shutoff when in the closed position.

End of Section

ENGINE-GENERATORS

PART 1 - GENERAL

1-1. SCOPE. This section covers the furnishing of diesel fuel engine-driven electric generator units. Each engine-generator shall be located outdoors in a weatherproof enclosure.

Each engine-generator shall be a skid-mounted package unit consisting of an engine, an alternator, auxiliary systems, controls, and accessories as specified, all mounted in a weatherproof enclosure, and as required for a complete operating system.

1-2. GENERAL. Equipment furnished under this section shall be assembled in full conformity with drawings, specifications, engineering data, instructions, and recommendations of the equipment manufacturer unless exceptions are noted by Engineer.

Requirements of the engine-generator specified herein shall be coordinated with the electrical section, plant control system section, miscellaneous piping section, the miscellaneous valves section, and the aboveground fuel storage tank section.

The contractor shall properly coordinate the work between the suppliers of the equipment to be used with or connected to the engine-generator to ensure that all required provisions for mounting the accessories are included.

1-2.01. General Equipment Stipulations. The General Equipment Stipulations shall apply to all equipment furnished under this section. If requirements in this specification differ from those in the General Equipment Stipulations, the requirements specified herein shall take precedence.

1-2.02. Coordination. All equipment specified in this section shall be furnished through a single engine-generator manufacturer who shall be responsible for the design, manufacture, coordination, and proper installation and operation of the entire system.

Each engine-generator unit shall be a standard product of the manufacturer and shall be a packaged type unit, fully shop assembled, wired and tested, requiring no field assembly of critical moving parts.

Contractor shall verify that each component of the system is compatible with all other parts of the system; that all piping, materials, and motor sizes are appropriate; and that all devices necessary for properly functioning system have been provided.

The engine-generator manufacturer shall coordinate requirements between the automatic transfer switch and the engine-generator.

Contractor shall, at his own expense, arrange for and obtain all necessary permits, inspections, and approval by the proper authorities in local jurisdiction of such work.

1-2.03. Governing Standards. Except where modified or supplemented by these specifications, all equipment and materials shall be designed and constructed in accordance with the latest applicable requirements of the standard specifications and codes of ANSI, ASTM, NEMA, IEEE, EEI, HEI, ISO, NFPA, SAE, and other such regularly published and accepted standards as well as state and local codes.

1-2.04. Power Supply. Site power supply provided will be 240 volts, 60 Hz, single phase for operation of the equipment and accessories. Each engine-generator shall be provided with a power panel sized to power the required loads inside the enclosure as specified herein. The engine (starting and controls) will operate from batteries specified herein. When needed, a control power transformer shall be provided for voltages other than the supply power voltage.

1-3. SUBMITTALS.

1-3.01. Drawings and Data. Complete assembly and installation drawings, together with detailed specifications and data covering materials, drive unit, parts, devices and accessories forming a part of the equipment furnished, shall be submitted in accordance with the submittals section. The data and specifications for each unit shall include, but shall not be limited to, the following:

Manufacturer, model, and type:

- Engine.
- Alternator.
- Enclosure.
- Battery charger and battery.
- Fuel oil cooler (if required by engine design).
- Silencer.

Engine output horsepower and efficiency curves at rated capacity.

Fuel consumption at rated capacity.

Ratings at specified conditions:

- Engine (net horsepower).
- Engine (maximum performance horsepower bare engine).
- Generator kW at specified power factor.
- Volts.
- Amperes.

Overall dimensions and weight:

- Length.
- Width.
- Height.
- Net weight.

Wiring diagrams and schematics, including the engine control panel and generator line circuit breaker.

Alternator insulation class and temperature ratings.

Alternator winding pitch.

Calculations or test results showing compliance with specified motor starting and voltage dip requirements.

Generator line circuit breaker rating.

Control panel layout, identifying location of all instrumentation being supplied.

Engine drawing to include location of all piping connections.

Operation instructions.

Letter from the engine-generator manufacturer confirming that the unit will provide the specified minimum kW rating at the specified design conditions and time duration.

Maximum output short circuit kVA available.

Exhaust gas emission data, maximum values at loads of 1/2, 3/4, and full:

Carbon Monoxide (CO), lb/hr

Nitrogen Oxides (NO_x), lb/hr

Sulfur Dioxide (SO₂), lb/hr

Particular Matter (PM), lb/hr

Temperature, F

Flow, acfm

Letter from the engine-generator manufacturer confirming that the unit is in full compliance with Federal EPA, State of Florida, and local emissions requirements.

Equipment skid drawing including material list.

Conformation confirming that the exhaust through the exhaust silencer does not exceed the specified maximum pressure loss at the specified power outage capacity of the unit and that the exhaust silencer provides sound attenuation equal to or greater at the specified frequencies.

Letter from the engine-generator manufacturer confirming that the enclosure is suitable for the specified wind velocity and is designed as specified for rain penetration when the unit is operating.

Name, address, and phone number of manufacturer's repair facility.

Color chart showing available options for the enclosure color. The color of the enclosure shall be as directed by Owner during shop drawing review.

Drawings showing engine-generator inside the enclosure that shows location of all enclosure mounted and engine-generator mounted equipment.

Drawings to indicate maintenance access clearances for electrical and mechanical equipment. Drawing to show location of all enclosures bracing and location of doors and removable panels.

Certificate of compliance.

1-3.02. Operation and Maintenance Manuals. Adequate operation and maintenance information shall be supplied as required in the Submittals section. Operation and maintenance manuals shall be submitted in accordance with the Submittals section. The operation and maintenance manuals shall be in addition to any instructions or parts lists packed with or attached to the equipment when delivered.

1-4. DELIVERY, STORAGE, AND HANDLING. Shipping shall be in accordance with the Shipping section. Handling and storage shall be in accordance with the Handling and Storage section.

1-5. SPARE PARTS. The following spare parts and accessories shall be furnished for each engine-generator in substantial wooden boxes with identifying labels and delivered to the vicinity of the project site or the Owner as directed:

<u>Spare Parts</u>	<u>Quantity</u>
Air filters.	2 sets
Oil filters.	4 sets
Fuel filters.	12 sets
V-belts.	1 sets

1-5.01. Padlocks and Keys. Two stainless steel padlocks and four sets of keys for each door shall be provided. All keys and padlocks are to be keyed the same.

PART 2 - PRODUCTS

2-1. SERVICE CONDITIONS. Each engine-generator unit shall be designed to operate under the following service conditions:

Ambient air temperature range	20 to 110 °F
Design wind speed	120 mph
Site elevations	
3151 Dr. Phillips	104.5 ft

Each engine-generator unit will be used as a power unit for selected electrical loads when the utility supplied power fails.

Each engine-generator shall automatically start and connect to the electrical load when initiated from the automatic transfer controls.

Fuel for each engine-generator will be furnished from an aboveground tank specified in section 13214, Aboveground Fuel Storage Tanks.

The engine-generator supplier shall provide the correct amount and grade of crankcase oil, coolant, and other fluids (except fuel) necessary for initial testing and operation.

2-2. PERFORMANCE AND DESIGN REQUIREMENTS. Each engine-generator unit shall be designed for the operating conditions and requirements as follows:

Pump Station Location	3151
Generator	
Minimum power rating capacity with accessories, for generator voltage output and service conditions specified herein.	338 kW
Output frequency.	60 Hz
Output voltage.	480Y/277V VAC

Output power factor. 0.8

Maximum voltage dip. [SEE PERFORMANCE TABLE]

Engine

Fuel supply.	No. 2 diesel
Maximum speed.	1,800 rpm
Minimum piston displacement.	661 in ³
Black start required.	Yes
Guaranteed Emissions	Tier 2
Maximum engine-generator length, including radiator discharge plenum.	20'-0"
Maximum engine-generator width, including air intake plenums.	14'-6"

Each engine-generator shall be designed to operated during a power outage for a minimum of 64 continuous hours and a maximum of 200 hours per year.

Engine-generators submitted with ratings in excess of current published data will not be acceptable.

The engine-generator shall at a minimum meet the required Environmental Protection Agency New Source Performance Standards emission regulation. The engine-generator supplier shall coordinate with the local air quality management authority to ensure the equipment meets all current local air emissions requirements.

Engine-generator supplier shall guarantee the equipment supplied meets all local air emissions requirements in place at the time of startup. Field testing of actual emissions will be required per section 3-3 to determine compliance with the emissions requirements.

Each engine-generator unit furnished, including any air intake or discharge plenums, shall be of a design that can be accommodated in the space as indicated on the drawings and as specified herein. Maximum outside dimensions of the engine-generator enclosure including any plenums shall be as specified.

Any special fittings or piping required for connection to fuel piping shall be furnished and installed.

2-2.01 Performance Table

Each engine-generator shall satisfactorily start the following loads, while meeting the indicated voltage dip.

Location: 3151

	<u>Load Description</u>	<u>Rating</u>	<u>Maximum Voltage Dip (%)</u>	<u>Time Delay (sec)</u>	<u>Comments</u>
Step 1	Static Load (Total)	40KVA	15	0	
	Elec Rm A/C	15kW	15	0	
	Pump Motor 1	60 Hp	15	0	VFD Starter
Step 2	Pump Motor 2	60Hp	15	20	VFD Starter
Step 3	Pump Motor 3	60Hp	15	40	VFD Starter
Step 4	Pump Motor 4	60Hp	15	60	VFD Starter

2-3. ACCEPTABLE MANUFACTURERS. Each engine-generator shall be a current production model and from the same manufacturer. The engine-generator shall be manufactured by the supplier Caterpillar or Cummins without exception.

The manufacturer of the engine-generator unit shall have a full-time, fully factory trained technical staff and an equipped 24 hour service facility having all personnel and all equipment required to maintain, repair, or overhaul the engine-generator unit and associated equipment.

2-4. ENGINE-GENERATOR UNIT.

2-4.01. Engine. Each engine shall be 4-stroke cycle type and shall be equipped with the following:

Electronic governor for isochronous regulation of engine speed from no load to full load alternator output.

Dry type air cleaner with replaceable elements.

2-4.02. Alternator. Each engine-generator alternator shall be a 4 pole, revolving field design with temperature compensated solid state voltage regulator, brushless rotating rectifier exciter system, and drip-proof construction with amortisseur windings. The alternator shall be directly connected to the engine flywheel housing, and the rotor shall be driven through a semi-flexible driving flange to ensure permanent alignment.

Frequency regulation shall be isochronous ± 0.15 Hz from no load to rated load. Voltage regulation shall be within ± 2 percent of rated voltage, steady state, from no load to full load. The momentary voltage drop shall not exceed the specified percent without starter coils dropping out or stalling the engine at any time when applying or starting the specified loads. Recovery to stable operation shall occur within 2 seconds.

The alternator shall have Class F insulation as defined by NEMA MG1-1.65 and temperature rise shall be within NEMA MG1-22.40 definition at rated condition.

Harmonic filters shall be provided where determined by the supplier for proper operation when powering solid-state motor starters.

An alternator winding heater shall be furnished as an integral part of the engine-generator unit. Alternator winding heater shall be rated 120 volts, single phase. The alternator winding heater control system shall include an interlock with the engine-generator unit so that the heaters are de-energized at all times that the generator field is energized. The supplier shall provide all internal alternator winding heater wiring and used branch circuit protection.

2-4.02.01. Surge Protection. Each engine-generator shall be provided with a voltage surge protection system installed in the generator terminal box or in a separate enclosure near the generator terminal box.

2-4.03. Fuel System. A remote aboveground fuel storage tank, as specified in Section 13214, will be the source of the diesel fuel. Each engine-generator unit shall be furnished with a complete fuel system including engine-driven fuel pump, engine supply and return line, and with all accessories as required for proper operation. All items shall be suitable for the specified fuel and located inside the enclosure and serviceable from inside the enclosure. The engine driven fuel pump shall transfer the fuel from the remote aboveground fuel storage tank to the engine-generator.

The fuel system shall be furnished with any equipment required for the engine to supply or return any unused portion of fuel back to the fuel storage tank with any level in the tank, as indicated on the Drawings.

All stainless steel flexible connectors shall be provided for the fuel supply and return lines.

A manual shutoff valve shall be located in the fuel supply piping outside the enclosure. The shutoff valves shall be of firesafe design and shall utilize secondary metal seating surfaces to ensure shutoff if the primary seats are destroyed by fire. Valves shall be manually operated and shall be of three-piece design ball valves with carbon steel body and end caps, stainless steel or hard chrome plated ball and stem, reinforced teflon seats and seals, and socket welding ends. Firesafe ball valves shall be Contomatics "C-1122-BB-FS" or Jamesbury "4C2236XT-1".

A fire valve shall be installed in the diesel fuel piping just inside the enclosure. The valve shall have a spring loaded handle mechanism to provide for automatic closure of the normally open ball valve. The fire valve shall be FM approved and shall be Jamesbury Figure "1075".

The combination fuel filter/separator shall be located inside the enclosure and upstream from the flexible connectors. The combination fuel filter/separator shall be a manifold unit with shutoff valves and shall permit servicing the filter/separator without engine shutdown. Filter/separator shall be manufactured by Racor or equal.

The diesel fuel valve train for the engine shall include an electrically operated solenoid valve for shutoff of the fuel supply on engine shutdown. The valve shall be DC powered and located upstream from the flexible connection in the fuel line and shall open when the engine start is initiated.

A suitable check valve shall be located in the fuel return line inside the enclosure. The check valve shall be suitable for the specified fuel and shall prevent the flow of the fuel back towards the engine.

Fuel oil coolers shall be provided if the engine fuel system absorbs heat from the unit injectors and surrounding jacket water. The fuel cooler shall be a radiator mounted, air cooled unit that uses the air flow from the radiator for the cooling air flow. To prevent over heating of the fuel in the day tank, the fuel oil cooler shall be adequately sized to cool the return fuel from the engine to the required fuel usage inlet temperature.

A siphon-break, normally open, solenoid valve shall be provided at the highest point of the fuel supply line. The anti-siphon valve shall be piped back to the above fuel storage tank vent line riser pipe to prevent moisture from entering the valve as indicated on the drawings. The valve shall be used to break siphon when open and to make siphon when closed. It shall be connected to the day tank level controller to energize (close) whenever fuel is required.

A tamper switch shall be added to the fuel tank to prevent fuel theft.

2-4.04. Exhaust System. Each engine-generator unit shall be furnished with a complete exhaust system including an exhaust silencer, exhaust piping, stainless steel bellows expansion joints, and accessories required for a complete operating system.

The silencer shall be chamber type, all welded AISI Type 304L stainless steel construction. Exhaust piping shall be Schedule 10S, AISI Type 304L stainless steel with butt welded fittings. The exhaust silencer shall be furnished with suitable stainless steel bracket supports for horizontal mounting on top of the enclosure. The silencer shall be sized so that the back pressure at rated capacity of the engine does not exceed one half the manufacturer's maximum allowable back pressure. The exhaust from the engine shall enter either the bottom or side. Silencers shall be Maxim "M51", Nelson "400" or equal.

Minimum silencer attenuation for the following mid band frequencies shall be as follows:

63 Hz	19 dB
125 Hz	29 dB
250 Hz	35 dB
500 Hz	33 dB
1,000 Hz	29 dB
2,000 Hz	28 dB
4,000 Hz	28 dB
8,000 Hz	28 dB

The exhaust shall discharge vertically at the silencer outlet. A rain cap shall be provided to prevent rain from entering the exhaust pipe. The rain cap shall open from exhaust pressure from

the engine and shall close when exhaust flow stops. The cap shall be stainless steel counter-balancing with vertical discharge.

Exhaust emission test ports shall be provided in the exhaust piping after the silencer. Ports shall be threaded and shall be provided with stainless steel threaded caps.

2-4.05. Starting System and Control Power. Each engine-generator unit shall be furnished with a complete electric motor start system including starting motors, battery pack with rack, cables, and battery charger.

The batteries shall be of the high rate, nickel-cadmium type and have a 12 volt output. The battery shall be electrically sized for the engine furnished to maintain minimum cell voltages of 0.65 volt per cell during initial starting, and 0.85 volt per cell throughout the cranking time for five consecutive starting attempts of 10 seconds each. Battery voltages shall be maintained under the conditions specified herein.

The battery charger shall be suitable for the nickel-cadmium battery pack. The charger shall have a DC output suitable to supply power for all continuous loads and to recharge the batteries from a fully discharged state to normal operating voltage within 8 hours. The battery charger shall be provided with a NEMA 2 corrosion resistant enclosure. The battery charger shall be provided with the following: on/off switch, DC ammeter, DC voltmeter, AC input and DC output circuit breakers or fuses, floating voltage equalization, equalizing timer, and relays with form c contacts for remote annunciation of loss of AC power, low battery voltage, and high battery voltage.

The batteries, battery rack, and battery charger shall be located inside a separate vented enclosure inside the engine-generator enclosure. The battery rack frame shall be constructed of corrosion resistant material.

The engine-generator shall automatically supply power to the remote bus that powers the battery charger when it is operating and when utility power is not available.

2-4.06. Cooling System. Each engine-generator unit shall be cooled with unit-mounted radiator cooling system complete with radiator, expansion tank, water pump, belt-driven fan, fan guard, thermostatic temperature control, high-water temperature cutout, electric jacket water heater and all accessories required for proper operation. The radiator shall be sized with sufficient capacity for cooling of the engine and all other accessories required for proper operation. The core shall be epoxy coated for ocean spray and the fan shall draw air over the engine and discharge through the radiator.

The cooling system shall be filled with a permanent antifreeze mixture of the ethylene glycol type with rust inhibitor.

The electric jacket water heater shall be furnished to maintain jacket water at 90°F with a winter ambient temperature as specified herein. The jacket water heater shall be thermostatically controlled.

2-4.07. Engine-Generator Enclosure. Each engine-generator unit, including its control panel, battery rack, battery charger, power panel, and other ancillary equipment, shall be housed in an

aluminum weatherproof enclosure, of the non-walk-in type. The enclosure shall be shop mounted on the engine generator skid or field erected.

Aluminum enclosure shall be Marine Grade formed sheet aluminum construction, made of modular panels and louvers. Posts, rails, channels, and roof bows shall be 6061-T6 extruded aluminum. The panels shall be 0.040 inches thick minimum.

The enclosure shall consist of two side walls, two end walls, and roof. The roof shall be braced as necessary to support the exhaust silencer. The enclosure shall be designed to withstand the specified wind velocity without damage. All bracing and reinforcing members shall be integral to the enclosure. Roof penetrations for the installation of the silencer shall be gasketed to prevent the entrance of rain.

Doors shall be provided and located for easy access to the engine-generator, controls, accessories, radiator fill, and to provide easy accessibility for maintenance. Doors shall be lockable and suitable for use with all stainless steel padlocks. The padlocks shall be suitable for re-keying.

Engine oil and coolant drains shall be piped to outside of enclosure, with lockable shutoff valves and caps. All enclosure penetrations shall be gasketed or sealed to prevent the entry of rodents.

The enclosure shall be provided with intake and exhaust louvers with dampers to open on engine start. Louvers and dampers shall be sized for 120 percent of the cooling air requirements. Louvers shall be AC powered closed and spring open on unit start. The louvers shall be screened from the inside to prevent the entry of birds.

The enclosure shall be rain tight type and shall be designed to prevent the entrance of rain at the specified wind velocity when the unit is operating and the wind direction at 90 degrees to the intake louvers. "Rain Resistant" louvers, vertical air turning plenums, or a combination of the two shall be provided.

AC/DC operated maintenance lights, controlled with a 1 hour, wind-up timer switch shall also be provided inside the enclosure. A duplex receptacle rated 20 amp, 125 volts with a weatherproof enclosure shall be mounted inside and near the middle of the enclosure.

The enclosure shall be pre-wired, requiring only external connection to the power panel and the control panel outputs.

The enclosure shall be provided with vertical air turning plenums for cooling air intake. The air inlet turning plenums shall be located on each side of the enclosure.

The enclosure shall be provided with vertical air tuning plenums for radiator discharge air. The radiator discharge plenum shall direct the air and mechanical noise upwards away from the unit, and shall be supplied with a bottom sump area, with a one inch drain and shutoff valve to remove any moisture.

The entire enclosure, except for the louvered openings, shall be provided with noise suppression insulation and be designed to limit mechanical noise to not more than 75 dB(A) at 25 feet from

any point of the enclosure when operating . Field sound level tests shall be performed on each unit as specified in the installation section of this specification.

The enclosure shall be thoroughly cleaned after assembly and etched to allow both the interior and exterior surfaces to be shop painted. The interior finish shall consist of at least one coat of paint as selected by the Owner.

The enclosure shall be as manufactured by Pritchard-Brown or equal.

2-4.08. Control Panel. Each engine-generator unit shall have a control panel mounted inside the enclosure with panel mounted controls accessible when the enclosure doors are open. The panel shall be provided with vibration isolators to prevent damage to the instruments from engine-generator vibration.

The control panel shall be automatic and safety type and shall, at a minimum, include all items required by NFPA 110, Level 1.

The control panel shall be provided with a four-position selector switch with the following positions: "MANUAL-OFF/RESET-STOP-AUTO". In the "MANUAL" position, the engine starting sequence shall be initiated providing local control for maintenance, in the "AUTO" position, the engine-generator will be remotely started and stopped by a run contract from the automatic transfer switch as described in specification 16491. Isolated contacts for when the unit is in the "AUTO" position shall be provided for remote indication.

Adequate clearance shall be provided between the panel and the engine to allow engine maintenance without moving the control panel. The control panel shall be provided with the following instruments and control devices in addition to those required by NFPA 110, Level 1.: The Metering equipment shall include 3-1/2-inch diameter meters.

Tachometer.

Non-resetable hour meter.

2% accuracy AC voltmeter, AC ammeter, voltmeter/ammeter selector switch with "off" position.

Two normally open dry contacts which close when the engine is running and open with it is stopped.

Dry contact that closes for remote common alarm.

Dry contact that closes when the control selector switch is in "auto" mode.

Frequency Meter

Engine water temperature

Lube Oil Pressure

Fault Indicators for the following:

Individual press-to-test fault indicator lights for low oil pressure

High water temperature

Low water level

Over speed

Over crank

2-4.09. Crankcase Vent Blow-By Absorber. Suitable crankcase ventilation shall be provided by the engine manufacturer to meet the applicable Tier level emission requirements.

2-4.10. Power Panel. Each engine-generator unit shall have a 12 minimum circuit 120/240-volt load center with main and feeder breakers, rated as needed. The load center shall be mounted inside the enclosure and isolated from generator vibration. The load center shall be pre-wired to all engine generator accessories as needed. The power panel shall supply power to the following:

Engine-generator starting system battery charger.

Enclosure lights and receptacles.

Day tank fuel system.

Enclosure intake and exhaust louvers/dampers.

Engine jacket water heater.

Alternator windings heater.

2-4.11. Generator Line and Generator Component Overcurrent Protection. A generator line circuit breaker rated for the generator output voltage, having the trip rating as needed, shall be provided on the output terminals. The line circuit breaker shall be pre-wired to the generator output terminals, and shall be provided within the generator enclosure in outdoor applications or shall be furnished in a skid mounted NEMA 1 enclosure for indoor applications.

Overcurrent protection devices shall be provided as needed by the system design to protect generator rotor and excitation system components.

2-4.12. Limiting Dimensions. Each engine-generator unit furnished shall be of a design that can be accommodated in the space available as specified herein and as shown on the drawings.

2-5. SHOP PAINTING. All steel and iron surfaces shall be protected by suitable coatings applied in the shop. Surfaces which will be inaccessible after assembly shall be protected for the life of the equipment. Coatings shall be suitable for the environment where the equipment is installed. Exposed surfaces shall be finished, thoroughly cleaned, and filled as necessary to provide a smooth, uniform base for painting. Electric motors, engine, alternator, enclosure, piping, and valves shall be shop primed and finish painted prior to shipment to the site.

Stainless steel, nonferrous, and nonmetallic surfaces shall not be painted.

2-6. SHOP TESTS. The manufacturer shall shop test each engine-generator set with its control panel and unit mounted radiator to demonstrate that the equipment conforms to specified requirements for load capacity.

All items included on the control panel shall be assembled, wired, and tested in the manufacturer's shop.

The tests shall consist of repeated starts and stops, operation under a load bank at specified capacity frequency, voltage, phase, and power factor for a minimum of 1 continuous hour, and tests to demonstrate that each safety shutdown device is working properly. Contractor shall submit certified copies of the shop test results prior to shipping the unit.

2-7. OPERATION INSTRUCTION. Step-by-step instructions shall be furnished by each engine manufacturer for each unit. The instructions shall include, but not be limited to, the following procedures or information:

Startup of the unit.

Normal shutdown of the unit.

Emergency shutdown of the unit.

Normal operation of the unit, typical temperatures, pressures, speed, etc., for gauges and instruments which are displayed on the panel.

The operation instructions shall be submitted for review in accordance with the submittals section. When the review is complete, the instruction sheets shall be printed on heavy paper or cardboard stock and laminated with clear plastic. Two copies of the laminated instructions shall be furnished with the unit. One copy shall be located or displayed at the control panel for the unit. The reserve copy shall be delivered to Owner. The instructions specified here are in addition to the operation and maintenance manuals required by the submittals section.

2-8. AIR EMISSIONS PERMIT. Contractor shall be responsible for preparing and submitting air emission permit application on behalf of the Owner to the local air quality authority for the unit being supplied based on the maximum number of operating hours specified herein and guaranteed emissions.

Permit to include provisions for the Owner to contact the local air quality authority for permission to operate the unit in the event the permit hours may be exceeded due to unforeseen conditions.

PART 3 - EXECUTION

3-1. INSTALLATION. Each engine-generator will be installed in accordance with the Equipment Installation section.

3-2. FIELD QUALITY CONTROL.

3-2.01. Installation Check. When required, an experienced, competent, and authorized representative of the manufacturer shall visit the site of the Work and inspect, check, adjust if necessary, and approve the equipment installation. The representative shall be present when the equipment is placed in operation in accordance with Startup Requirements section, and shall revisit the job site as often as necessary until all trouble is corrected and the equipment installation and operation are satisfactory in the opinion of Engineer.

The manufacturer's representative shall furnish a written report certifying that the equipment has been properly installed and lubricated; is in accurate alignment; is free from any undue stress imposed by connecting piping or anchor bolts; and has been operated under full load conditions and that it operated satisfactorily.

All costs for these services shall be included in the contract price.

3-2.02. Installation Supervision. When required, the equipment manufacturer shall furnish a qualified field installation supervisor during the equipment installation.

All costs for these services shall be included in the contract price.

Manufacturers' installation supervisor shall observe, instruct, guide, and direct the installing contractor's erection or installation procedures. The equipment manufacturer will be provided with written notification 10 days prior to the need for such services.

3-3. FIELD TESTING. Manufacturer's field services shall be provided for field testing. All costs for these services shall be included in the contract price.

3-3.01. Performance Test. Each unit shall be mechanically checked for proper operation. Each alarm and safety shutdown shall be checked by artificially simulating an alarm condition. Defective equipment and controls disclosed by the tests shall be replaced or corrected, and the packages placed in satisfactory operating condition.

The complete system (engine, generator, fuel system, fuel storage tank, and control panel) shall be field tested together by the manufacturer as a complete system to assure compatibility.

The tests shall consist of repeated starts and stops, operation under a load bank at the specified power rating and power factor for the durations listed below, and test of successful operation under different loads and various fuel tank levels (minimum and full tank fuel levels). Before each test, the engine shall be brought to steady state conditions as determined by the instrument readings.

Four (4) continuous hours at specified power rating and power factor
Starting and proper operation of the specified loads in the order listed
for a minimum of two (2) continuous hours
Demonstration of four (4) starts

Contractor shall furnish the lubricants, load bank, and the fuel for the tests.

At the option of the Owner, an independent laboratory will be provided by the Owner for the exhaust gas sampling and analysis during the 4 hour load test of the engine. The laboratory analysis will be used for verification the units meets the guaranteed emissions.

Any retesting or modifications to the equipment to meet the above requirements and emission guarantees shall be approved by the Engineer. All costs of modifications and retesting, including the independent laboratory for air emission testing, shall be at no cost to the Owner.

The following items shall be measured, recorded at 15 minute intervals, and submitted in a field test report:

- Outdoor ambient temperature.
- Indoor ambient temperature.
- Barometric pressure.
- kW output.
- Engine speed, rpm.
- Engine jacket water temperature.
- Engine oil pressure.
- Start time.
- Completion time.

Test reports shall verify that the specified tests have been performed and shall state results. Test results shall be submitted as required in the Submittals section.

3-3.02. Field Sound Level Test. The installed equipment shall be tested for noise. The maximum measured sound levels outside the enclosure shall not exceed the specified noise level at any octave band frequencies, at the specified distance when operating alone. Background noise shall be included in the specified sound level. The Contractor shall take background noise measurements as necessary to determine the level of sound attenuation required for the enclosures.

Any retesting or modifications to the equipment or enclosure to meet the above requirements shall be approved by the Engineer. All costs of modifications and retesting shall be at no cost to the Owner.

Test reports shall verify that the specified tests have been performed and shall state results. Test results shall be submitted as required in the Submittals section.

3-4. TRAINING. The manufacturer shall conduct on-site training to instruct the Owner on operation and maintenance of the units. The training shall be arranged and coordinated with the Owner through the Contractor. All costs for these services shall be included in the contract price. Contractor shall include a minimum of four (4) clock hours for up to five (5) persons for each model unit.

End of Section

This page was left blank intentionally

REMOVAL OF EXISTING ENGINE-GENERATORS

PART 1 - GENERAL

1-1. SCOPE. This section covers the removal of existing diesel fueled engine generator and associated engine generator accessories. The engine generator for PS 3151 (Dr. Phillips) is a 375 kW diesel fueled unit.

The engine generator and associated equipment shall be demolished and removed from its current outdoor location by the Contractor. FDEP Permit application for this work shall be done by Orange County Risk Management Division.

1-2. GENERAL.

1-2.01. Coordination. Equipment removed under this section shall be inspected, disassembled, and removed in full conformity with drawings, specifications, engineering data, instructions, and recommendations furnished by the equipment manufacturer unless exceptions are noted by the Engineer.

The engine – generator shall be removed completely including all accessories. The Owner will not be responsible for any parts damaged by the Contractor.

The removal of the equipment shall be coordinated with the modifications to the existing engine-generator area outside. The Contractor shall coordinate the removal from service and storage of the existing engine – generator with the Owner to minimize impact on operations schedules.

The Contractor shall, at this own expense, arrange for and obtain all necessary permits, inspections, and approval by the proper authorities in local jurisdiction of such work.

The General Equipment Stipulations shall apply to all equipment furnished under this section.

1-3. STORAGE AND HANDLING. Equipment shall be stored and handled in accordance with the General Equipment Stipulations and the equipment manufacturer's recommendations.

PART 2 - EXECUTION

2-1. DECOMMISSION. The engine generator, associated wiring for the engine – generator as well as the day tank, exhaust silencer, and all accessories shall be demolished and removed by the Contractor in accordance to all applicable regulatory requirements.

Provisions shall be made for temporary onsite engine generators to be used as back-up sources of power, prior to decommissioning. All cable and connectors shall be provided.

End of Section

This page was left blank intentionally

ABOVEGROUND FUEL STORAGE TANKS

PART 1 - GENERAL

1-1. SCOPE. This section covers the furnishing and installation of aboveground, steel fuel storage tanks and accessories as indicated herein. FDEP Permit application for this work shall be done by Orange County Risk Management Division.

Each tank shall be either constructed with porous concrete between two steel walls or constructed of steel and encased in concrete.

1-2. GENERAL. Equipment furnished under this section shall be fabricated and installed in full conformity with drawings, specifications, engineering data, instructions, and recommendations of the manufacturer unless exceptions are noted by Engineer.

1-2.01. General Equipment Stipulations. The General Equipment Stipulations shall apply to all equipment furnished under this section. If requirements in this specification differ from those in the General Equipment Stipulations, the requirements specified herein shall take precedence.

1-2.02. Coordination. All equipment for this section shall be furnished by or through a single manufacturer who shall be responsible for the design, coordination, and proper installation and operation of the entire system.

Contractor shall properly coordinate the work between the suppliers of equipment to be used with or connected to each storage tank to ensure that all required provisions for mounting the accessories are included.

Where two or more units of the same class of equipment are required, they shall be the product of a single manufacturer; however, all the component parts of the system need not be the products of one manufacturer.

Contractor shall verify that each component of the system is compatible with all other parts of the system; that all piping, materials, pumps, and motor sizes are appropriate; and that all devices necessary for a properly functioning system have been provided.

Contractor shall, at his own expense, arrange for and obtain all necessary permits, inspections, and approval by the proper authorities in local jurisdiction of such work.

1-2.03. Governing Standards. Except as modified or supplemented herein, all work covered by this section shall be performed in accordance with all applicable municipal codes and ordinances, laws, and regulations which pertain to such work. In case of a conflict between these specifications and any state law or municipal ordinance, the latter shall govern. All materials and construction methods shall comply with the applicable provisions of the following standards:

ASTM A283 "Low and Intermediate Tensile Strength Carbon Steel Plates, Shapes,

and Bars," or ASTM A569 "Steel, Carbon, Hot-Rolled Sheet and Strip, Commercial Quality."

American Petroleum Institute.

National Fire Protection Association.

Underwriters' Laboratories UL 142, Steel Aboveground Tanks for Flammable and Combustible Liquids; UL 1709, and Rapid Rise Fire Tests for a two hour period.

Applicable local regulations and ordinances.

1-2.04. Power Supply. Power supply for tank fill assembly control panel shall be 120 volts, 60 Hz, single phase.

1-3. SUBMITTALS.

1-3.01. Drawings and Data. Complete fabrication, assembly, and installation drawings, together with detailed specifications and data covering materials used, parts, devices, and other accessories forming a part of the tank furnished, shall be submitted in accordance with the Submittals section.

The data shall also indicate the sizes of all major tank components and full information and details concerning field assembly and installation.

The manufacturer's standard calibration charts shall be submitted.

1-3.02. Operation and Maintenance Data and Manuals. Adequate operation and maintenance information shall be supplied as required in the Submittals section. Operation and maintenance manuals shall be submitted in accordance with the Submittals section. The operation and maintenance manuals shall be in addition to any instructions or parts lists packed with or attached to the equipment when delivered.

1-4. DELIVERY, STORAGE, AND HANDLING. Shipping shall be in accordance with the Shipping section. Handling and storage shall be in accordance with the Handling and Storage section.

Each tank and component parts shall be adequately protected during all transportation, loading and unloading, storage, installation, and subsequent construction activities. All nozzles shall be properly protected at all times and shall be plugged to prevent contamination of the tank interior. Repairs of minor damage, including scratches and abrasions, may be made where permitted by Engineer in the manner recommended by the manufacturer. If a tank is damaged beyond reasonable repair, in the opinion of Engineer, it will be rejected and shall be replaced by Contractor with an undamaged unit.

At no time shall a tank be dropped or rolled. All lifting shall be done using the lifting lugs or suitable slings.

PART 2 - PRODUCTS

2-1. SERVICE CONDITIONS.

All equipment shall be designed to operate under the following service conditions:

Type of environmental exposure.	Outdoor
Design ambient air temperature range.	20 to 100 °F

2-2. PERFORMANCE AND DESIGN REQUIREMENTS. Each aboveground fuel storage tank shall be from the same manufacturer and meet the following performance and design requirements as follows:

Pump Station	3006	
Capacity.	1,500	gal
Liquid stored.	No. 2 Diesel	
Minimum insulation thickness.		
Con Vault type	6	in
Phoenix type	3	in
Limiting dimensions.		
Length.	132	in
Width.	68	in
Height.	52	in
Minimum primary tank wall thickness.	3/16	in
Minimum top wall thickness of secondary tank, if applicable.	1/4	in
Minimum sides and bottom wall thickness of secondary tank, if applicable.	3/16	in
Quantity of supply pipe extractor fittings with caps.	1	
Supply pipe extractor fitting size.	4	in
Supply pipe extractor fitting cap size.	1 ½	in
Quantity of supply pipe foot valves.	1	
Supply pipe foot valve size.	1.5	in
Vent cap size	1 ½	in
Primary tank emergency vent size	6	in

The primary internal steel tank shall be vented and normally used to store the specified product at atmospheric pressure but shall be designed and tested at the factory before shipment to maintain a 5 psi internal air pressure.

The primary internal steel tank shall be suitable to withstand internal corrosion from the liquid stored at a maximum temperature of 150°F.

The porous lightweight concrete shall be placed between the two steel walls at the factory or the tank shall be encased at the factory and either method shall provide a minimum two-hour fire rating.

The secondary outer steel tank or the concrete encased tank shall be suitable to withstand external corrosion due to atmospheric conditions.

2-3. ACCEPTABLE MANUFACTURERS. The tank shall be current production model as manufactured by either ConVault or Phoenix Envirovault, or equal.

2-4. CONSTRUCTION. Each storage tank shall be either double wall type with lightweight concrete between the two steel walls or single wall tank with styrofoam insulation and HDPE secondary containment and encased in concrete. Each tank shall be aboveground horizontal rectangular, atmospheric type with support rails or support legs and accessories as indicated on the drawings and specified herein. Each tank shall be secured to a concrete base by anchor bolts (cast in reinforced concrete) through the tank support as indicated on the drawings. Each entire tank package system shall be electrically grounded.

The materials for construction shall be in accordance with the following requirements:

ConVault Type

Tank (primary)	Carbon steel.
Encasement	Concrete, with minimum design strength of 3,000 psi, containing no aggregate, suitable for preventing the internal tank temperature from rising 260°F during a 2000°F fire test for 2 hours.
Annular space	Styrofoam insulation
Secondary containment	HDPE

Phoenix Type

Primary Tank	Carbon steel
Secondary Tank	Carbon steel
Annular Space	Porous lightweight concrete

The primary internal steel tank and, if applicable, the secondary outer steel tank shall both be of welded construction throughout and each shall be UL 142 listed and labeled.

The tank shall have a minimum of 2 hour fire rating and UL listed supports. The tank shall be UL 2085 listed, and shall meet the requirements of the Uniform Fire Code 7907, and NFPA 30/30A. .

Upon completion of construction, the exterior of the of the double walled steel tank's outer tank and the inner tank interior seams shall be ground free of rough areas such that finished welds are full and rounded.

Each tank shall be constructed, and provided with all connections as required to permit testing of the tank containment including a nonmetallic secondary containment tank, if applicable.

2-4.01. Surface Preparation. After fabrication, all metal surfaces and connections shall be blasted clean in conformance with the paint manufacturer's recommendations. All mill scale, rust, and contaminants shall be removed before shop primer is applied.

2-4.02. Painting. All exterior surfaces of the primary internal tank and either the secondary outer steel tank or the concrete encasement shall be shop primed and painted in accordance with the tank manufacturer's requirements.

2-4.03. Concrete. Porous lightweight concrete insulation or concrete encasement shall be suitable for preventing the primary tank temperature from rising 260°F during 2000°F fire test for the fire rating specified above.

2-4.04. Connections and Openings. Each fuel storage tank shall be supplied with the following connections and openings:

Primary tank emergency vent connection.	6	in
Fill connection.	4	in
Supply connection quantity.	1	
Supply connection size.	4	in
Return connection quantity.	1	
Return connection size.	2	in
Leak monitor connection.	2	in
Level transducer connection.	4	in
Tank vent connection.	1-1/2	in
Secondary tank emergency vent connection, if applicable.	*	
Secondary tank test connection with cap, if applicable.	*	
Manway connection.	18	in
Extra connection quantity.	2	
Extra connection size.	4	in

*As recommended by the tank manufacture if applicable.

All connections on the fuel storage tank shall be located on the top of the tank and shall be forged steel threaded pipe nipples, located as indicated on the drawings. All connections on the tank that are not used shall be capped.

Extra connections on the tank shall be located on the top and shall be forged steel threaded pipe nipples with caps, located as indicated on the drawings.

Secondary outer tank emergency vent connection size and secondary tank testing connection size shall be as required for tank furnished.

All connections shall be sealed to prevent moisture from penetrating the outside of the secondary outer steel tank and shall maintain the specified fire rating.

The manway for the tank shall be an all welded extension cylinder in the top of the tank.

2-5. ACCESSORIES. The accessories for each fuel storage tank shall be provided as indicated on the drawings and as specified herein.

2-5.01. Tank Fill Assembly. Each fuel storage tank shall be furnished with a complete fill system including remote fill box, fill pipe, level gauge, shutoff valves, NEMA 4X stainless steel control panel (painted white), mounting pole, mounting bracket, and all accessories as indicated on the drawings and specified herein. All items shall be suitable for the specified fluid.

The remote fill box shall be a grade level fill box with spill containment, overflow prevention and automatic fill shut-off. The remote fill box shall be a weatherproof, lockable stainless steel enclosure (painted white), with hinged doors and the following items:

Three-inch quick-disconnect coupling.

Check valve.

Electrically actuated shutoff valve.

Spill containment basin.

Hand pump.

Fire valve with fusible link.

Manual firesafe shutoff valve.

Fitting for outlet of product.

Fuel supply truck ground stud.

Ground lug for grounding the enclosure as indicated on the drawings.

Mounting pole, brackets, and other accessories as required

The remote fill box shall include a rainproof, lockable, NEMA 4X, stainless steel construction enclosure (painted white) with hinged door for housing the control panel. All stainless steel surfaces shall be properly prepared to prevent flaking and/or peeling of applied paint. The control panel shall include the following items:

Control power On-Off switch and control power available indicating light.

Pushbuttons for Open-Close control of fill valve.

Fill valve Open-Close indicating lights.

Fuel tank leak indication light.

90 percent and 95 percent tank level indicating lights.

Alarm horn sounding for 90 percent full, 95 percent full, and leak detected, with silence pushbutton.

Continuous percent level indicator.

The control panel shall control the operation of the remote fill box mounted fuel transfer valve. The control panel shall provide restriction of fuel transfer when the tank is at the 90 percent full level, and stop fuel transfer when the tank is at the 95 percent full level.

Terminal connections for tank-mounted level transducer, 30 percent, 90 percent, 95 percent, and 100 percent level float switches, and leak detection float switch shall be provided. All cable required between control panel and electrical components mounted on the tank shall be furnished under this section.

Dry Form C dry contacts rated 5 amps at 120 VAC shall be provided for tank level at 100 percent and 30 percent, and for leak detected.

4-20 mA output signal for tank level

The tank fill assembly shall be Simplex Compact Automatic Fuel Port as manufactured by Simplex, Inc., or equal.

The fill pipe for the fuel storage tank shall extend from 4 inches above the bottom of the tank to the remote fill box. The lower end of the fill pipe shall be cut off at 45 degree angle, and the upper end inside the tank shall include an anti-siphon bleed hole. Suitable fittings shall also be provided for the fill pipe to connect to the tank connection.

A suitable means of sealing around the sensor wire entering the leak detection riser pipe shall be provided to prevent the annular space from being contaminated. Suitable fittings shall also be provided for the level transmitter to connect to the tank connection.

2-5.02. Supply Pipe Assembly. Each supply pipe assembly for the fuel storage tank shall consist of an extractor fitting with a top cap, suction piping, and a foot valve. Each suction pipe length shall be such that the foot valve is located 4 inches above the bottom of the tank. The extractor fitting shall thread onto the tank connection. The tank connection location shall be as indicated on the drawings. The extractor fitting shall be OPW "233-E" with cap. The foot valve shall be of the double poppet type with metal-to-metal replacement seats, 20 mesh Monel inlet screen, and shall be OPW "86".

2-5.03. Vent Cover. A vent cover suitable for the specified tank vent size, shall be provided on each fuel storage tank vent as indicated on the drawings. The vent pipe shall screw into the coupling that is screwed onto the tank connection. The cover shall have an aluminum body, 40 mesh [40 mm] screen over the outlet, and shall prevent rain from entering the vent line. The vent cover shall be OPW"23".

2-5.04. Primary Internal Tank Emergency Vent. An emergency vent shall be provided on the top of each fuel storage tank as indicated on the drawings. The emergency vent shall relieve

internal pressure in excess of 8 oz/sq in. The emergency vent shall be Morrison "Figure No. 244", or equal.

2-5.05. Secondary Outer Tank Emergency Vent. A secondary outer tank emergency vent shall be provided on top of each fuel storage tank for the space between the two steel walls as indicated on the drawings. The emergency vent shall relieve internal pressure in excess of 8 oz/sq in. The vent size shall be as recommended by the tank manufacturer.

2-5.06. Tank Support. Tank support rails or tank support legs shall be provided with each tank at the spacing recommended by the manufacturer. Rails shall be fabricated of carbon steel as a part of the tank structure. Legs shall be fabricated of concrete as a part of the tank structure. Rails or legs shall be of the size and design required to adequately support the tank and its contents and shall be suitable to withstand the buoyancy forces when the tank is empty and covered with water.

2-5.07. Leak Detection System. Each tank shall be provided with a leak detection system to continuously monitor the fuel storage tank. The system shall consist of porous insulation, a riser pipe open on the bottom end and placed vertically next to and below the inner primary tank. Any leakage shall flow through the insulation to the riser pipe.

The system shall use a single float switch to continuously monitor the presence of liquid in the riser pipe.

The leak detection control panel is specified with the fill assembly and shall be located on the remote fill box.

2-5.08. Level Transducer and Float Switches. Each tank shall be furnished with a level transducer and float switch assembly to monitor fuel level in the tank. The level transducer shall output an analog signal to the level indicator mounted on the control panel. 30, 90, 95, and 100 percent level float switches shall be vertical action SPST 120 VAC pilot duty. Level transducer and float switches shall be wired to terminals in a weather proof conduit box mounted on top of the tank.

2-5.09. Return Assembly. Each return pipe assembly shall include a 1-1/2 inch riser pipe that extends 12 inches above the bottom of the tank up to the tank connection. Riser pipe shall include anti-siphon bleed hole at the top of the pipe inside the tank. Suitable fittings shall be provided for attaching the return piping to the tank connection.

2-5.10. Gauge Stick. A suitable gauge stick and calibration chart shall be supplied with each tank.

PART 3 - EXECUTION

3-1. FIELD TESTING. After shipment to the jobsite, but prior to installation, each inner primary tank shall be pressure tested at 5 psi for one hour. The inner primary tank shall be checked for leaks, using an air gauge. During testing, connections may be plugged but shall not be blocked or plugged on the inside. If there are leaks or indications of leaks, the tank shall be replaced with a new tank and tested after shipment to the jobsite.

3-2. INSTALLATION. Each tank shall be installed in accordance with the manufacturer's instructions, these specifications, detail drawings, and to the satisfaction of Engineer.

3-3. FIELD PAINTING. After installation of the fuel storage tanks, the contents of the tank and the words "FLAMMABLE – KEEP FIRE AWAY" shall be painted on four sides of each tank shall in an arrangement and location acceptable to the Owner. Letters shall be of the block type, at least 5 inches, spaced and proportioned to provide a well-balanced appearance. Two coats of paint shall be applied.

3-4. FIELD QUALITY CONTROL.

3-4.01. Installation Check. An experienced, competent, and authorized representative of the manufacturer shall visit the site of the Work and inspect, check, adjust if necessary, and approve the equipment installation. The representative shall be present when the equipment is placed in operation in accordance with Startup Requirements section, and shall revisit the job site as often as necessary until all trouble is corrected and the equipment installation and operation are satisfactory in the opinion of Engineer.

The manufacturer's representative shall furnish a written report certifying that the equipment has been properly installed and lubricated; is in accurate alignment; is free from any undue stress imposed by connecting piping or anchor bolts; and has been operated under full load conditions and that it operated satisfactorily.

All costs for these services shall be included in the contract price.

3-4.02. Installation Supervision. The equipment manufacturer shall furnish a qualified field installation supervisor during the equipment installation.

All costs for these services shall be included in the contract price.

Manufacturers' installation supervisor shall observe, instruct, guide, and direct the installing contractor's erection or installation procedures. The equipment manufacturer will be provided with written notification 10 days prior to the need for such services.

3-5. CLEANING. The exposed finish shall be inspected after completing system installation, including pipe connections, fittings, valves, and specialties. Burrs, dirt, and construction debris shall be removed and damaged finishes, including chips, scratches, and abrasions shall be repaired.

3-6. PROTECTION. The equipment shall be protected after installation, but prior to final acceptance by Owner. Protection provisions shall be as recommended by the manufacturer, and shall include provisions to prevent rust, mechanical damage, and foreign objects entering the equipment.

3-7. INITIAL TANK FILL. Upon completion, Contractor shall fill each fuel storage tank with the specified liquid.

End of Section

INSTRUMENTATION AND CONTROL SYSTEM

PART 1 – GENERAL

1-1. SCOPE. This section covers the furnishing and installation of instrumentation and control systems at the following site.

Pump Station PS 3151 (Dr. Phillips)

PS 3151 is currently equipped with an RTU, SCADA Type 3 panel, including communications equipment. This panel is comprised of a Siemens 216-2 PLC, interface relays, an MDS model 9810 spread spectrum radio and other pertinent equipment. The RTU panel shall be removed and returned to the Owner. The antenna mast and antenna at this station shall be relocated and reused with the new pump station configuration. The Contractor shall provide and install a new SCADA RTU and pump control panel, including radio that is integrated into one panel as well as a backup float control panel. These new panels shall include devices shown on the schematic diagrams per division 13 and 16 specifications and where referenced by division 13 and 16 specifications. Although PS 3151 will be equipped with 5 pumps, the RTU panel shall be a Type 6 configuration and shall have all supporting equipment installed such that a pump may be installed in any slot in a wetwell and the supporting equipment (rails, piping, VFD's, controls, etc) shall be in place to allow its operation. Solid state reduced voltage bypass starters will be provided for each installed pump. The Contractor shall coordinate with Orange County Utilities for the relocation of the antenna mast and antenna.

It shall be the responsibility of the CONTRACTOR to mount the RTU, install all required hardware and software components necessary for a complete functional RTU.. A Florida certified electrical CONTRACTOR shall perform the installation. All work shall be in accordance with the current edition of the NFPA, NEC, UL and COUNTY electrical codes.

A certified radio technician shall install all RF cable, antennas and associated equipment.

The CONTRACTOR shall provide conduit and wire from all instruments to the SCADA RTU panel, provide the power required for all instruments and SCADA RTU panel, and provide conduit from the SCADA RTU panel to the bio-solids control panel as shown on the drawings. Analog wire shall be run in separate conduit from VAC wiring to minimize inductance and false signals in the analog signal wiring and the contractor shall provide a drain wire that is connected to the ground at the RTU cabinet. The drain wire shall not be connected at the device end so as to minimize ground loops.

The CONTRACTOR shall be responsible to run power circuits to the RTU panel as shown on the drawings. The systems shall be furnished as specified, complete with all software, human machine interface (HMI) hardware, input/output hardware, instrumentation, and all devices, accessories, appurtenances, testing, and training necessary for proper operation. Software configuration and programming of the PLC and Local Operator Interface shall be performed by the System Supplier. All configuration activities at the Central site shall be performed by Orange County Utilities

1-1.01. Associated Sections. This section also includes the equipment and services specified in the following sections.

Section 13530	PROGRAMMABLE LOGIC CONTROLLERS
Section 13540	MULTIPLE ADDRESS RADIO EQUIPMENT
Section 13550	SOFTWARE CONTROL BLOCK DESCRIPTIONS
Section 13561	PANEL MOUNTED INSTRUMENTS
Section 13562	FLOW INSTRUMENTS
Section 13563	PRESSURE AND LEVEL INSTRUMENTS
Section 13565	MISCELLANEOUS INSTRUMENTS
Section 13570	PANELS, CONSOLES, AND APPURTENANCES

1-2. GENERAL. Equipment furnished and installed under this section shall be fabricated, assembled, erected, and placed in proper operating condition in full conformity with the drawings, specifications, engineering data, instructions, and recommendations of the equipment manufacturer, unless exceptions are noted by Engineer.

1-2.01. General Equipment Stipulations. The General Equipment Stipulations shall apply to all equipment and materials furnished under this section. If requirements in this specification differ from those in the General Equipment Stipulations, the requirements specified herein shall take precedence.

1-2.02. Drawings. The drawings indicate locations and arrangements of equipment and may include installation details and block and one-line diagrams showing connections and interfaces with other equipment. The input/output (I/O) lists are attached as an appendix to the Programmable Logic Controllers section.

Principal components of the instrumentation systems shall be as indicated on the P&ID drawings and instrument device schedule attached to this section.

1-2.03. Codes, Permits and Agency Approvals. All work performed and all materials used shall be in accordance with the National Electrical Code, and with applicable local regulations and ordinances. Where mandated by codes, assemblies, panels, materials, and equipment shall be listed by Underwriters' Laboratories (UL). Contractor shall, as part of their work, arrange for and obtain all necessary permits, inspections, and approvals by the authorities having local jurisdiction of such work. This shall include any third-party inspections and testing of panels and equipment.

1-2.04. Supplier's Qualifications. Equipment and software furnished under this section and under other related sections listed in the scope paragraph above shall be designed, coordinated, and supplied by a single manufacturer or supplier, hereinafter referred to as the System Supplier. The System Supplier shall be regularly engaged in the business of supplying computer-based monitoring, control, and data acquisition systems. The Contractor shall utilize the services of the System Supplier to coordinate all control system related items, to check-out and calibrate instruments, and to perform all testing, training, and startup activities specified to be provided.

The System Supplier shall be one of the following integrators:

- Curry Controls Inc - <http://www.currycontrols.com/>
- CEC Controls Company Inc – <http://www.cecontrols.com>
- DCR Engineering - <http://www.dcreng.com>
- Siemens Water Technology Control Systems - <http://www.water.siemens.com>

1-2.05. Coordination. Systems supplied under this section shall be designed and coordinated by System Supplier for proper operation with related equipment and materials furnished by other suppliers under other sections of these specifications, under other contracts, and, where applicable, with related existing equipment. All equipment shall be designed and installed in full conformity with the drawings, specifications, engineering data, instructions, and recommendations of the manufacturer, and the manufacturer of the related equipment.

1-2.06. Related Equipment and Materials. Related equipment and materials may include, but will not be limited to, instrumentation, motor controllers, valve actuators, chemical feeders, analytical measuring devices, conduit, cable, and piping as described in other sections or furnished under other contracts.

1-2.07. Device Tag Numbering System. All devices shall be provided with permanent identification tags. The tag numbers shall agree with System Supplier's equipment drawings and shall be as close as practical to the tag numbers used on the project drawings and device schedules. All field-mounted transmitters and devices shall have stamped stainless steel identification tags. Panel, subpanel, and rack-mounted devices shall have laminated phenolic identification tags securely fastened to the device. Hand-lettered or tape labels will not be acceptable.

1-3. GENERAL REQUIREMENTS. The drawings and specifications indicate the extent and general arrangement of the systems. If any departures from the drawings or specifications are deemed necessary by System Supplier, details of such departures and the reasons shall be submitted to Engineer for review with or before the first stage submittal. No departures shall be made without prior written acceptance.

The specifications describe the minimum requirements for hardware and software. Where System Supplier's standard configuration includes additional items of equipment or software features not specifically described herein, such equipment or features shall be furnished as a part of the system and shall be warranted as specified herein.

1-3.01. Governing Standards. Equipment furnished under this section shall be designed, constructed, and tested in accordance with IEEE 519, ANSI C37.90, FCC Part 15 - Class A, and NEMA ICS-1-109.60.

1-3.02. Dimensional Restrictions. Layout dimensions will vary between manufacturers and the layout area indicated on the drawings is based on typical values. The System Supplier shall review the contract drawings, the manufacturer's layout drawings and installation requirements, and make any modifications requisite for proper installation subject to acceptance by Engineer.

At least three feet of clear access space shall be provided in front of all components of the instrumentation and control system components.

1-3.03. Workmanship and Materials. System Supplier shall guarantee all equipment against faulty or inadequate design, improper assembly or erection, defective workmanship or materials, and leakage, breakage, or other failure. Materials shall be suitable for service conditions.

All equipment shall be designed, fabricated, and assembled in accordance with recognized and acceptable engineering and shop practice. Individual parts shall be manufactured to standard sizes and thicknesses so that repair parts, furnished at any time, can be installed in the field. Like parts of duplicate units shall be interchangeable. Equipment shall not have been in service at any time prior to delivery, except for testing.

1-3.04. Corrosive Fluids. All parts, which are exposed to corrosive conditions, shall be made from corrosion resistant materials. System Supplier shall submit certification that the instrument manufacturer approves the selection of materials of primary elements that are in contact with the specified process fluid to be inert to the effects of the process fluid.

1-3.05. Appurtenances. Signal converters, signal boosters, amplifiers, special power supplies, special cable, special grounding, and isolation devices shall be furnished as needed for proper performance of the equipment.

1-3.06. Programming Devices. A programming or system-configuring device shall be provided for systems that contain any equipment that requires such a device for routine calibration, maintenance, and troubleshooting. The programming device shall be complete, newly purchased for this project, and shall be in like-new condition when turned over to Owner at completion of startup.

1-4. SUBMITTALS. Complete dimensional, assembly, and installation drawings, wiring and schematic diagrams; and details, specifications, and data covering the materials used and the parts, devices and accessories forming a part of the system furnished, shall be submitted in accordance with the submittals section. Submittal data shall be grouped and submitted in three separate stages. The submittal for each stage shall be substantially complete. Individual drawings and data sheets submitted at random intervals will not be accepted for review. Equipment tag numbers or identifications used on the drawings shall be referenced where applicable.

1-4.01. First Stage Submittal. The first stage submittal shall include the following items.

- a. A detailed list of any exceptions, functional differences, or discrepancies between the system proposed by System Supplier and this specification.
- b. Product catalog cut sheets on all hardware and software items, clearly marked to show the model number, optional features, and intended service of each device.
- c. A brief, concise description of the proposed system, including major hardware and software components and personnel training.
- d. A block diagram or schematic drawing showing the principal items of

- equipment furnished, including model numbers, and their interrelationships.
- e. Drawings showing floor space or desktop area requirements for all equipment items, including allowances for door swings and maintenance access.
 - f. Environmental and power requirements, including heat release information for each equipment item.
 - g. Standard field termination drawings for all process input/output equipment, showing typical terminations for each type of point available in the system.
 - h. A copy of the proposed software licenses for all software associated with the system.
 - i. Outline for training classes.

1-4.02. Second Stage Submittal. Before any equipment is released for shipment to the site and before factory testing is scheduled, the following data shall be submitted.

At System Supplier's option, the first and second stage submittals may be combined.

- a. Detailed functional descriptions of all software modules specified and furnished as part of System Supplier's standard system. The descriptions shall be identified with the applicable specification paragraph.
- b. Complete panel fabrication drawings and details of panel wiring, piping, and painting. Panel and subpanel drawings shall be to scale and shall include overall dimensions, metal thickness, door swing, mounting details, weight, and front of panel arrangement to show general appearance, with spacing and mounting height of instruments and control devices.
- c. Wiring and installation drawings for all interconnecting wiring between components of the system and between related equipment and the equipment furnished under this section. Wiring diagrams shall show complete circuits and indicate all connections. If panel terminal designations, interdevice connections, device features and options, or other features are modified during the fabrication or factory testing, revised drawings shall be submitted before shipment of the equipment to the site.
- d. Review of drawings submitted prior to the final determination of related equipment shall not relieve System Supplier from supplying systems in full compliance with the specific requirements of the related equipment.
- e. Input/output listings showing point names, numbers, and addresses. Input/output identification numbers from the contract documents shall be cross-referenced in this submittal.
- f. Proposed lesson plans or outlines for all training courses specified herein, including schedule, instructors' qualifications and experience, and recommended prerequisites.
- g. Standard system engineering and user manuals describing the use of the system and application programming techniques for creating reports, graphics, database, historical records, and adding new process I/O nodes to the system.

1-4.03. Third Stage Submittal. Complete system documentation, in the form of Operation and Maintenance Manuals, shall be submitted before the commencement of field acceptance testing. Operation and Maintenance Manuals shall include complete instruction books for each item of equipment furnished. Where instruction booklets cover more than one specific model or range of device, product data sheets shall be included which indicate the device model number and other special features. A complete set of "as-built" wiring, fabrication, and interconnection drawings shall be included with the manuals. If field-wiring modifications are made after these drawings are submitted, the affected drawings shall be revised and resubmitted. Supplemental documentation requirements are as follows:

- Complete schematic and wiring diagram, in the latest version of AutoCAD, and bill of materials on compact disc;
- Four maintenance manuals with above drawings and manufacturer's maintenance literature bound in three-ring binders;
- A laminated copy of the schematic and wiring diagram shall be permanently affixed to the interior side of the exterior enclosure door.
- Documented HMI and/or RTU application program suitable for programming updates for the RTU.

1-5. PREPARATION FOR SHIPMENT. All electronic equipment and instruments shall be suitably packaged to facilitate handling and to protect against damage during transit and storage. All equipment shall be boxed, crated, or otherwise completely enclosed and protected during shipment, handling, and storage. All equipment shall be protected from exposure to the elements, shall be kept dry at all times, and shall not be exposed to adverse ambient conditions.

Painted surfaces shall be protected against impact, abrasion, discoloration, and other damage. Painted surfaces that are damaged prior to acceptance of equipment shall be repainted to the satisfaction of Engineer.

Each shipment shall include an appropriate shipping list that indicates the contents of the package, including the specific instrument tags. The shipping list shall be accessible without exposing the instruments to the atmosphere. The shipping list shall also contain any cautionary notes regarding storage of the instruments, including requirements to protect the instrument from static discharge, desensitizing chemicals (solvents, paints, etc.), or ambient atmospheric conditions.

Individual instruments shall be appropriately tagged or labeled to positively identify the device. All identification shall be visible without the need to unpack the instrument from its protective packaging.

Instrument shipment and storage requirements shall be coordinated with Engineer or Owner prior to shipment. System Supplier shall provide adequate storage and be ready to accept the shipment before shipping any equipment to the site. Additional shipping and storage requirements shall be as detailed in the individual instrument specifications.

Components which are shipped loose due to transportation limitations shall be assembled and disassembled by the manufacturer prior to shipment to assure that all components fit together and are adequately supported.

1-6. DELIVERY, STORAGE, AND SHIPPING. Shipping shall be in accordance with the shipping section. Handling and storage shall be in accordance with the handling and storage section.

1-7. SPARE PARTS. In addition to spare parts and consumable items specified in other sections, the following spares and consumable items shall be provided:

<u>Spare Parts</u>	<u>Quantity</u>
Lamps for indicating lights	1 full set

1-7.01. Packaging. All spare parts shall be delivered to Owner before final acceptance of the system. Packaging of spare parts shall provide protection against dust and moisture and shall be suitable for storage. Circuit boards and other electronic parts shall be enclosed in anti-static material. All packages shall be clearly marked with the manufacturer's name, part number or other identification, date of manufacture, and approximate shelf life.

1-7.02. Replacement. System Supplier may utilize spare parts and supplies during system installation, de-bugging, startup, or training, but shall restore all such materials and supplies to the specified quantities before final acceptance of the systems.

PART 2 - PRODUCTS

2-1. GENERAL REQUIREMENTS. All equipment furnished under each section referenced in SCOPE is a part of this section and shall be selected by System Supplier for its superior quality and intended performance. Equipment and materials used shall be subject to review.

2-1.01. Standard Products. The systems furnished shall be standard products. Where two or more units of the same type of equipment are supplied, they shall be the products of the same manufacturer; however, all components of the systems furnished hereunder need not be the products of one manufacturer unless specified herein.

To the extent possible, instruments used for similar types of functions and services shall be of the same brand and model line. Similar components of different instruments shall be the products of the same manufacturer to facilitate maintenance and stocking of repair parts. Whenever possible, identical units shall be furnished.

2-2. PERFORMANCE AND DESIGN REQUIREMENTS. The design of the systems furnished hereunder shall utilize concepts, techniques and features that provide maximum reliability and ease of maintenance and repair. The systems shall include board-level devices such as light emitting diodes or other indicators to facilitate quick diagnosis and repair. Diagnostic software shall be furnished to facilitate system-level troubleshooting.

Where redundant hardware is provided, the system shall be capable of performing all specified functions, without reconfiguring hardware or software, with only one device of each category in service.

2-2.01. Factory Assembly. Equipment shall be shipped completely factory assembled, except where its physical size, arrangement, configuration, or shipping and handling limitations make the shipment of completely assembled units impracticable.

2-2.02. Expandability. The system shall be capable of expansion as follows:

<u>Future Requirement</u>	<u>Quantity</u>
I/O points	20%

2-3. POWER SUPPLY AND INSTRUMENT SIGNAL. Power supply to all control system equipment will be 120 volts, 60 Hz, single phase. System Supplier shall be responsible for distribution of power among enclosures, consoles, peripherals, and other components of the system from the power supply receptacles and junction boxes indicated on the drawings. Power distribution hardware shall include cables and branch circuit overcurrent protection installed in accordance with the electrical section.

Unless otherwise indicated, power supply to the instrumentation will be unregulated 120 volts ac. Unless otherwise indicated, all transmitted electronic analog instrument signals shall be 4-20 mA dc and shall be linear with the measured variable.

2-3.01. Facility Distribution System. Equipment not indicated to be powered from an uninterruptible power source shall be suitable for being supplied from the facility distribution system and shall be capable of withstanding voltage variations of ± 10 percent and harmonics up to the limits of IEEE 519 without affecting operation. System Supplier shall provide voltage conditioning or filtering equipment if necessary to meet the requirements specified.

2-3.02. Power Supplies. Power supplies for voltages other than those listed above shall be an integral part of the equipment furnished. Internal power supplies shall be regulated, current limiting, and self-protected.

2-3.03. Surge Withstand. All equipment shall meet all surge withstand capability tests as defined in ANSI C37.90 without damage to the equipment.

2-3.04. Uninterruptible Power Supply. An uninterruptible power supply (UPS) shall be furnished hereunder to power the equipment indicated on the drawings or will be furnished under another section. System Supplier shall be responsible for coordinating the size of the UPS unit with the equipment furnished hereunder, and shall advise Engineer if a unit of higher capacity is necessary.

2-4. SERVICE CONDITIONS AND ENVIRONMENTAL REQUIREMENTS. The equipment provided for the instrumentation and control system shall be suitable for the service conditions specified in the attached equipment sections.

All equipment shall be designed and selected to operate without degradation in performance throughout the environmental extremes specified. Equipment shall be designed to prevent the generation of electromagnetic and radio frequency interference and shall be in compliance with FCC Rules and Regulations, Part 15, for Class A computing devices.

2-4.01. Ambient Temperature and Elevation. All components shall be able to operate at –22 degrees Fahrenheit or lower to 140 degrees Fahrenheit and higher at 95 percent humidity.

2-4.02. Deleterious Effects. All system equipment will be installed in areas without anti-static floor construction and without any provisions for control of particulates or corrosive gases other than ordinary office-type HVAC filtering. System Supplier shall furnish any additional air cleaning equipment, anti-static chair pads, or other protective measures necessary for proper operation of the system.

All input/output hardware shall meet or exceed, without false operation, all requirements of NEMA ICS-1-109.60, Electrical Noise Tests.

2-4.03. Noise Level. The equivalent "A" weighted sound level for any system equipment located in the control room, except printers, shall not exceed 35 dBA. The sound level for printers shall not exceed 65 dBA. Sound reduction enclosures shall be provided where necessary to comply with these limits.

2-4.04. Lightning Protection. In addition to other environmental protection specified herein, the entire system shall be provided with lightning protection. Lightning protection measures shall include the following.

2-4.04.01. Grounding. All major components of the system shall have a low resistance ground connection. Grounding system provisions indicated on the drawings shall be modified as recommended by System Supplier.

2-4.04.02. Surge Suppressors. Surge and lightning suppressors shall be non-faulting, non-interrupting, and shall protect against line-to-line and line-to-ground surges. Devices shall be solid-state metal oxide varistor (MOV) or silicon junction type, with a response time of less than 50 nanoseconds. Surge protective devices shall be applied for the following:

- a. All power connections to RTUs, PLCs, DCUs, instruments and control room equipment. Surge arresters shall be Transtector "ACP-100 Series", Power Integrity Corporation "ZTA Series", Phoenix Contact "Mains PlugTrab", or MCG Surge Protection "400 Series".
- b. All analog signal circuits where any part of the circuit is outside of the building envelope. Circuits shall be protected at both the transmitter and the control system end of the circuit. Surge protection devices shall not impede or interfere with the use of smart transmitter calibration/communication. Protection devices located near the transmitter shall be Edco SS64 series or Telematic "TP48." Protection devices in control panels shall be Edco PC-642, Transtector "TSP Series", Telematic "SD Series", Phoenix Contact "PipeTrab Series", or Citel "BP1-24."
- c. All radio antenna leads. Surge protection devices shall be as specified in Multiple Address Radio Equipment section.

2-5. SOFTWARE DOCUMENTATION. System Supplier shall furnish complete documentation on all software supplied with the systems specified herein. Operating systems,

compilers, assemblers, and utility and diagnostic programs that are standard commercial products of third parties need not be included in the magnetic media backup. Software documentation shall consist of the following principal items.

- a. One backup set of any integrated circuit or solid-state memory-based plug-in firmware used.
- b. Two complete back up copies of system and application software in executable format on magnetic media compatible with the system furnished.
- c. Three sets of user reference manuals for all standard system and application software.
- d. One set of user reference manuals for all operating system software.
- e. Three sets of printed as-built reference documentation for any special software provided specifically for this contract.
- f. For each licensed software product, all documentation provided by the product manufacturer shall be provided. This includes all reference manuals and any other documents that were provided by the manufacturer. There should be one set of this documentation for each and every piece of equipment provided. Multiple pieces of similar equipment or software require multiple copies of this documentation.

2-6. SOFTWARE LICENSE. All software programs supplied as a standard part of System Supplier's products for this project shall be licensed to Owner for use on the system specified herein. Such license shall not restrict Owner from using the software on the system provided hereunder or its replacement. Owner shall have the right to make copies of the software for use on the system provided. Specific requirements of System Supplier's software license are subject to review and approval by Owner and Engineer. Each RTU shall have the latest RTU SCADA application license compatible with the existing central configuration.

2-7. INSTALLATION TEST EQUIPMENT. All necessary testing equipment for calibration and checking of system components shall be provided by System Supplier. System Supplier shall also furnish calibration and maintenance records for all testing and calibration equipment used on the site if requested by Engineer.

2-8. PROGRAMMING DEVICES. The following programming devices shall be provided for the instruments specified in other sections:

<u>Instruments Requiring Programming Devices</u>	<u>Quantity of Programming Devices</u>
Flow instruments	1
Pressure and level instruments	1

2-9. PROGRAMMING SOFTWARE. The following programming software shall be provided for the instruments specified in other sections:

<u>Instruments Requiring Programming Software</u>	<u>Number of Copies of Programming Software</u>
Flow instruments	1
Pressure and level instruments	1

PART 3 – EXECUTION

3-1. INSTALLATION REQUIREMENTS. The installation of equipment furnished hereunder shall be by the Contractor or their assigned subcontractors.

3-1.01. Field Wiring. Field wiring materials and installation shall be in accordance with the requirements listed in the Standards and Construction Specifications Manual (SCSM) Section 3413 3.01 and 3.02.

3-1.02. Instrument Installation. Instruments shall be mounted so that they can be easily read and serviced and so that all appurtenant devices can be easily operated. Installation details for some instruments are indicated on the drawings.

3-1.03. Salvage of Existing Equipment. Existing equipment and materials removed or replaced under this contract shall be delivered to Owner at a location designated by Owner, or shall be properly disposed of at Owner’s discretion. Care shall be taken to avoid damage to equipment delivered to Owner.

Any mounting brackets, enclosures, stilling wells, piping, conduits, wiring, or openings that remain after removal of equipment and support hardware shall be removed or repaired in a manner acceptable to Owner and Engineer. Transmitters or switches containing mercury shall be removed and disposed of by personnel trained in the handling of hazardous materials and using approved procedures.

3-2. SYSTEM SOFTWARE CONFIGURATION. The central site system software will be configured by Orange County Utilities. The PLC program shall be written and configured by the system supplier.

3-3. SYSTEMS CHECK. System Supplier shall provide the services of a trained and experienced field supervisor to assist the installation contractor during installation, and to calibrate, test, and advise others of the procedures for installation, adjustment, and operation.

3-3.01. Field Manager. Not used.

3-3.02. Field Inspection at Delivery. The field supervisor shall inspect major equipment items within five working days of delivery, to assure that the equipment was not damaged during shipment and shall supervise or assist with unpacking, initial placement, and initial wiring of the system.

3-3.03. Field Calibration of Instruments. After each instrument has been installed, a technical representative of System Supplier shall calibrate each instrument and shall provide a written

calibration report for each instrument, indicating the results and final settings. The adjustments of calibrated instruments shall be sealed or marked, insofar as possible, to discourage tampering. Instrument calibration shall be done before checkout of the system operation. A typical instrument calibration report is attached to the end of this section.

3-3.04. Training for Installation Personnel. Not used.

3-3.05. Field Inspection Prior to Start Up. After installation and wiring connections are complete, the field supervisor, with additional System Supplier's personnel shall verify that each external connection to the system is correctly wired and field process components and devices are functioning as intended. A minimum of 4 working days shall be included for this task, but System Supplier shall be responsible for completing the following scope of work.

3-3.05.01. Analog Signals. Analog input signals shall be simulated at the transmitting source, and verified to be received at the proper register address in the control system. Analog outputs shall be generated at the control system, and verified to be received with the correct polarity, at the respective receiving device.

3-3.05.02. Discrete Signals. Discrete input and output signals shall be simulated and verified that they are received at the respective receiving device, and at the proper voltage.

3-3.05.03. Devices by Other Suppliers. If interrelated devices furnished by other suppliers, under other contracts, or by Owner, such as valve actuators, motor controls, chemical feeders, and instruments, do not perform properly at the time of system checkout, the field supervisor shall use suitable test equipment to introduce simulated signals to and/or measure signals from these devices to locate the sources of trouble or malfunction.

3-3.05.04. System Check Out Report. The System Supplier shall submit a written report on the results of such tests to Engineer. Additional documentation shall be furnished as requested by Engineer to establish responsibility for corrective measures. System Supplier shall verify, in writing, to Engineer or Owner that System Supplier has successfully completed the external connection check before beginning system startup or field acceptance testing.

3-3.06. Start Up Assistance. After the field supervisor has completed the system check and submitted his report, System Supplier shall supply a factory-trained engineer to provide onsite start up assistance. During the startup period, these personnel shall thoroughly check all equipment, correct any deficiencies, and verify the proper operation of all components. 5 working days shall be included for this task.

3-4. TESTING. The system shall be acceptance tested at the factory and on site.

System Supplier shall prepare a testing procedure to be approved by Owner and Engineer that shall demonstrate that the system conforms to the specifications. The testing procedure shall be submitted at least 30 days in advance of testing. The testing shall be conducted by System Supplier and witnessed by Owner and/or Engineer.

System Supplier shall notify Engineer and Owner in writing at least 14 days before the proposed testing date. If the factory acceptance test is concluded unsuccessfully, the test shall be repeated. System Supplier shall reimburse Owner and Engineer for all expenses incurred in connection

with attending repeated factory or site testing necessitated by system failure or inadequate preparation.

3-4.01. Factory Acceptance Testing. After system assembly and debugging at System Supplier's facility, the system shall be tested before the system is shipped to the site. The factory test shall be conducted on the PLC/RTU panel.

The Contractor shall arrange for the shop assembled panel to be electrically shop tested, by the System Supplier, before shipment to the site. The System Supplier shall do the following:

1. Verify during the FAT tests that each device in the panel is connected to the correct power source.
2. Simulate each PLC analog input at the field interface terminal strip and examine the corresponding PLC register to verify the response.
3. Simulate each PLC discrete input at the field interface terminal strip and examine the corresponding PLC register to verify the response.
4. Simulate each PLC analog output within the PLC and verify at the corresponding field interface terminal strip.
5. Simulate each PLC discrete output within the PLC and verify at the corresponding field interface terminal strip.
6. Demonstrate interconnections among devices within each panel by exercising the connected devices together.
7. Functionally test the PLC software algorithm utilizing panel hardware, hardware simulation switch boxes and field devices.
8. Provide all necessary equipment and services to test communications as indicated on the drawings.

3-4.01.03. PLC Program Emulation. When PLC program emulation testing software is required in Programmable Logic Controller Section, its functionality shall be demonstrated as part of the factory acceptance test.

3-4.02. Site Acceptance Testing. Site acceptance testing shall be per the requirements of the SCSM, Section 3413 3.05.

3-4.03. Service. Service requirements shall be per the requirements of the SCSM, Section 3413 3.06.

3-4.04. Warranty. The RTU shall have a two-year after acceptance warranty to include lightning damage. The RTU supplier shall provide all material and labor to repair or replace failed components at no cost to UTILITIES.

Software shall be warranted for the life of the system. Subsequent revisions of the RTU software shall be made available to UTILITIES at not cost to UTILITIES. Any errors, bugs, faults or other malfunctions due to software in the RTU shall be corrected at no cost to UTILITIES.

Warranty service shall be completed within the following period of time:

1. Major issues rendering the RTUs non-functional shall have on site response with qualified personnel within one business day.
2. Minor issues involving a failure of the RTU or any of its components shall have on site response within qualified personnel within two business days.
3. UTILITIES will have the option to proclaim any hardware or software failure an emergency if in the opinion of UTILITIES the failure could result in a public health or safety concern.

3-5. TRAINING. System Supplier shall conduct training courses for personnel selected by Owner. Four categories of training, instrument, control system maintenance, programmer (PLC software), and supplemental shall be provided. Training shall be conducted by experienced instructors who are familiar with the specific system supplied.

3-5.01. General Training Requirements. In general, System Supplier's standard training courses may be used to meet the training objectives specified. Where standard courses do not meet these objectives, additional coursework shall be developed. Clock hour requirements for each level of training are shall be as listed. A "clock hour" is defined as one hour of instruction or supervised training exercise. Training hour requirements are the number of hours of training to be provided for each student. Additional training time shall be provided if considered necessary to meet the training objectives.

3-5.01.01. Training Costs. All costs associated with the training program; excluding travel, lodging, and per diem expenses for Owner's and Engineer's personnel to attend off-site training programs; shall be the responsibility of System Supplier and shall be included in the contract price.

3-5.01.02. Lessons. Training lesson plans and other information for the second stage submittal as defined herein shall be submitted at least 30 days prior to the start of training.

3-5.01.03. Video Recording. Not used.

3-5.02. Instrument Training. Training on the calibration, maintenance, troubleshooting, and repair for the instrument devices provided under this project shall be provided. Training shall also be provided for any hand-held or computer-based calibration devices and their associated software. 4 hours of training for 4 students shall be provided at the Owner's facility.

3-5.03. System Maintenance Training. System maintenance training shall be provided to enable Owner's personnel to perform routine and preventive maintenance, troubleshoot, and repair all hardware furnished with the system. Maintenance and repair instruction shall assume that Owner's personnel will repair equipment by replacing circuit boards and modules, and shall not include instruction on circuit board level repair.

3-5.03.01. Classes. All maintenance training shall be conducted at Owner's facilities. Each session shall consist 6 hours of training for 4 of the Owner's personnel.

3-5.03.02. Content of Classes. The training shall cover at least the following topics:

- a. Preventive, scheduled maintenance for all equipment.
- b. Function and normal operation of circuit boards and modules.
- c. Diagnosis of hardware failures to the faulted board or module.
- d. Removal and replacement of removable circuit boards and modules.
- e. Emergency maintenance and restoration procedures.

The maintenance training program shall be developed for personnel who have experience in electronics maintenance and repair and a general knowledge of computer systems, but not necessarily any familiarity with the specific hardware furnished.

3-5.04. Operator Training. Not used.

3-5.05. Programmer Training (HMI Software). Not used.

3-5.06. Programmer Training (PLC Software). Programmer training shall be provided for the PLC software furnished. Programmer training shall be provided on at least the following topics.

- a. File management and backup procedures.
- b. Documentation printing options.
- c. Entering I/O and database points.
- d. Logic function programming.
- e. PID loop programming and tuning.
- f. Error recovery and interpretation of errors.
- g. Communication protocol set-up and diagnostics.

PLC software programmer training shall be conducted at Owner's or Engineer's facilities within 30 days of delivery of PLC's. The training shall consist of 4 hours of instruction for 4 students.

3-5.07. Supplemental Training. System Supplier shall provide additional training to Owner's personnel on topics of Owner's choosing. Supplemental training shall be conducted in one session at Owner's facilities using the hardware and software installed for this project. The training shall consist of 4 hours of instruction for 4 students.

End of Section

This page was left blank intentionally

INSTRUMENT NAME & SERVICE:		
BRAND & MODEL NO.:		
TAG OR LOOP NO.:		
INPUT/OUTPUT RANGE:		
INPUT	ACTUAL OUTPUT	DESIRED OUTPUT
PROPORTIONAL BAND:		
RESET:		
POSITION OF SWITCHES, JUMPERS, ETC.		
COMMENTS:		
DATE OF CALIBRATION: CALIBRATED BY:		
Black & Veatch	INSTRUMENT CALIBRATION REPORT	Figure 1-13500

This page was left blank intentionally

Instrument Device Schedule - Legend/Description Sheet											
Item. This is an arbitrary sequential number which is for reference only.											
Tag. This is the ISA (or similar) alpha tag representing the function of the instrument.											
Loop. This is the numeric (or alphanumeric) loop designation for the instrument.											
Service Description. This is the description of the instrument service (i.e. Filter No. 1 Loss-of-Head).											
Device Type & Size. This is the instrument device type and should match the description as listed in the specification. Where appropriate, the size of the device (such as diameter of flowmeters) will be listed.											
Output Type. This generally will be '4-20 mA' or 'Dry Contact'. It could also be a serial output for smart devices (such as HART or FLD-BUS) but only if the serial output is the primary I/O interface.											
Output Range. This is the calibrated range for analog devices or the trip point(s) for discrete devices.											
Power. This will typically be either '2-wire' for loop powered devices or '4-wire' for 120 volt powered devices.											
InstDet. This is a reference to the applicable installation detail on the drawings if applicable.											
Loc. Drwg. This is the drawing number of the electrical plan or instrument location plan where the device is shown.											
P&I Drawing. This is the drawing number of the P&ID where the device is shown.											
Comments/Notes. This column may include a cross reference to another specification section where applicable or to a note which provides additional information. Notes are appended to the end of the device schedule listings.											

Item	System	Tag		Service Description	Device Type	Size	Output Type	Output Range	Power	Inst Det	P&I Drwg.	Comments/Notes
1	3151	FE	3151-01	FLOW ELEMENT	MAGNETIC FLOW TUBE	16"	NA	0-6750 GPM	N/A	I-9	I-5	
2	3151	FIT	3151-01	STATION FLOW	MAGNETIC FLOW INDICATING TRANSMITTER	N/A	4-20 mA	0-6750 GPM	4-WIRE	I-9	I-5	
3	3151	LS	3151-11B	WELL 1 OFF	BALL FLOAT	N/A	DRY CONTACT	N/A	N/A	I-9	I-5	With Intrinsically Safe Relay
4	3151	LS	3151-11C	WELL 1 LEAD	BALL FLOAT	N/A	DRY CONTACT	N/A	N/A	I-9	I-5	With Intrinsically Safe Relay
5	3151	LS	3151-11D	WELL 1 LAG	BALL FLOAT	N/A	DRY CONTACT	N/A	N/A	I-9	I-5	With Intrinsically Safe Relay
6	3151	LS	3151-11E	WELL 1 LAG 2	BALL FLOAT	N/A	DRY CONTACT	N/A	N/A	I-9	I-5	With Intrinsically Safe Relay
7	3151	LS	3151-11F	WELL 1 LAG 3	BALL FLOAT	N/A	DRY CONTACT	N/A	N/A	I-9	I-5	With Intrinsically Safe Relay
8	3151	LS	3151-11G	WELL 1 LAG 4	BALL FLOAT	N/A	DRY CONTACT	N/A	N/A	I-9	I-5	With Intrinsically Safe Relay
9	3151	LS	3151-11H	WELL 1 LAG 5	BALL FLOAT	N/A	DRY CONTACT	N/A	N/A	I-9	I-5	With Intrinsically Safe Relay
10	3151	LS	3151-12B	WELL 2 OFF	BALL FLOAT	N/A	DRY CONTACT	N/A	N/A	I-9	I-5	With Intrinsically Safe Relay
11	3151	LS	3151-12C	WELL 2 LEAD	BALL FLOAT	N/A	DRY CONTACT	N/A	N/A	I-9	I-5	With Intrinsically Safe Relay
12	3151	LS	3151-12D	WELL 2 LAG	BALL FLOAT	N/A	DRY CONTACT	N/A	N/A	I-9	I-5	With Intrinsically Safe Relay
13	3151	LS	3151-12E	WELL 2 LAG 2	BALL FLOAT	N/A	DRY CONTACT	N/A	N/A	I-9	I-5	With Intrinsically Safe Relay
14	3151	LS	3151-12F	WELL 2 LAG 3	BALL FLOAT	N/A	DRY CONTACT	N/A	N/A	I-9	I-5	With Intrinsically Safe Relay
15	3151	LS	3151-12G	WELL 2 LAG 4	BALL FLOAT	N/A	DRY CONTACT	N/A	N/A	I-9	I-5	With Intrinsically Safe Relay
16	3151	LS	3151-12H	WELL 2 LAG 5	BALL FLOAT	N/A	DRY CONTACT	N/A	N/A	I-9	I-5	With Intrinsically Safe Relay

Black and Veatch

Instrument Device Schedule

Item	System	Tag		Service Description	Device Type	Size	Output Type	Output Range	Power	Inst Det	P&I Drwg.	Comments/Notes
17	3151	LSHH	3151-11I	WELL 1 HI HI	BALL FLOAT	N/A	DRY CONTACT	N/A	N/A	I-9	I-5	With Intrinsically Safe Relay
18	3151	LSHH	3151-11J	WELL 1 HI HI	BALL FLOAT	N/A	DRY CONTACT	N/A	N/A	I-9	I-5	With Intrinsically Safe Relay
19	3151	LSHH	3151-12I	WELL 2 HI HI	BALL FLOAT	N/A	DRY CONTACT	N/A	N/A	I-9	I-5	With Intrinsically Safe Relay
20	3151	LSHH	3151-12J	WELL 2 HI HI	BALL FLOAT	N/A	DRY CONTACT	N/A	N/A	I-9	I-5	With Intrinsically Safe Relay
21	3151	LSLL	3151-11A	WELL 1 LOW	BALL FLOAT	N/A	DRY CONTACT	N/A	N/A	I-9	I-5	With Intrinsically Safe Relay
22	3151	LSLL	3151-12A	WELL 2 LOW	BALL FLOAT	N/A	DRY CONTACT	N/A	N/A	I-8	I-5	With Intrinsically Safe Relay
23	3151	LT	3151-11	WETWELL 1 LEVEL	RADAR ELEMENT	N/A	4-20 mA	0-23 FT	2-WIRE	I-9	I-5	Intrinsically Safe with Intrinsic Safety Barrier
24	3151	LT	3151-12	WETWELL 2 LEVEL	RADAR ELEMENT	N/A	4-20 mA	0-23 FT	2-WIRE	I-9	I-5	Intrinsically Safe with Intrinsic Safety Barrier
25	3151	PI	3151-01	DISCHARGE PRESSURE	GAUGE	N/A	N/A	0-100 PSI	N/A	I-9	I-5	Diaphragm Seal
26	3151	PIT	3151-01	STATION DISCHARGE PRESSURE	PRESSURE INDICATING TRANSMITTER	N/A	4-20 mA	0-100 PSI	2-WIRE	I-9	I-5	Diaphragm Seal
27	3151	YS	3151-20	BUILDING HIGH TEMPERATURE	THERMOSTAT		DRY CONTACT	NA	N/A	NA	I-5	
28	3151	ZS	3151-20A	BUILDING INTRUSION SWITCH	DOOR SWITCH		DRY CONTACT	NA	N/A	NA	I-5	

PROGRAMMABLE LOGIC CONTROLLERS

PART 1 - GENERAL

1-1. SCOPE. This section covers programmable logic controllers (PLCs), including associated input/output hardware to control process equipment and serve as the interface to field devices.

1-1.01. Control System. The Instrumentation and Control System section shall apply to all equipment furnished under this section. Additional PLC software requirements are indicated in Software Control Block Descriptions section.

1-2. GENERAL. Equipment furnished and installed under this section shall be fabricated, assembled, erected, and placed in proper operating condition in full conformity with the drawings, specifications, engineering data, instructions, and recommendations of the equipment manufacturer, unless exceptions are noted by Engineer.

1-2.01. General Equipment Stipulations. The General Equipment Stipulations shall apply to all equipment and materials furnished under this section. If requirements in this specification differ from those in the General Equipment Stipulations, the requirements specified herein shall take precedence.

1-2.02. Drawings. Supplementing this section, the drawings indicate the number and sizes of PLCs, locations of PLCs, and provide diagrams and schematics regarding connection and interaction with other equipment. All hardware, including power supplies, special cables, and other appurtenant equipment, shall be provided to meet the functional requirements described herein and indicated on the drawings.

1-2.03. I/O List. An input/output (I/O) field device signal listing is included as an appendix attached to this section.

1-3. SUBMITTALS. Submittals shall be as specified in the Instrumentation and Control System section.

1-4. DELIVERY, STORAGE, AND SHIPPING. Delivery, storage and shipping shall be as specified in the Instrumentation and Control System Section.

1-5. SPARE PARTS. Spare parts shall be furnished as follows:

<u>Spare Part</u>	<u>Quantity</u>
Processor modules	1 of each type used
I/O modules	1 of each type used

PART 2 - PRODUCTS

2-1. GENERAL. All equipment furnished under this section shall be expressly selected by System Supplier for its superior quality for the intended purpose and shall comply with the following requirements.

2-1.01. Interchangeability. All programmable logic controller systems shall be products of the same manufacturer and of the same series or product line. Processors, local and remote input/output hardware, communications modules, and specialty modules such as coprocessors and ASCII modules shall be interchangeable among all I/O panels and systems. PLC modules and hardware by other manufacturers will be acceptable only if the PLC manufacturer does not offer suitable modules and hardware for the same functions.

2-1.02. Initial, Spare, and Future Memory (RAM). System Supplier shall provide adequate memory for the amount of I/O, control algorithms, and communications in the PLC. If the PLC specified below does not have enough memory for the required application, the Contractor/Utilities Approved Programmer shall submit an alternate Siemens processor and I/O configuration. Panel construction may not begin until the Contractor /Utilities Approved Programmer certifies that the specified PLC configuration is appropriate for the application.

2-1.03. Spare I/O. Each PLC input/output enclosure shall be provided with at least 20 percent spare inputs and outputs of each type. Spare I/O shall be installed, wired, and interfaced properly to the terminal strip. In the case of spare discrete outputs, interfaced properly to the terminal strip includes output relays and sockets. The spare I/O shall be in addition to any I/O installed and reserved for future process signals as may be indicated on the I/O list. In addition, each PLC input/output enclosure shall be capable of accommodating 20 percent of additional input/output capacity of each type as originally assembled, without the need for additional expansion racks, communication adapters, cables, or PLC power supplies..

2-1.04. Expandability. Each PLC processor and associated I/O shall have a future expandability of at least 50 percent of the provided system.

2-1.05. Acceptable Manufacturers. The PLCs shall be Siemens model 6ES7315-2AH14-0AB0 with maximum ram installed, without exception. Contractor is to verify PLC part number with manufacturer and use latest version of CPU series, or manufacturer's most current model, subject to Orange County acceptance.

2-1.06. Signal Power Supplies. Regulated dc power supplies shall be provided in each PLC enclosure for analog inputs, digital inputs, . Power supplies shall be suitable for an input voltage variation of ± 10 percent, and the supply output shall be fused or protected against short-circuiting. Output voltage regulation shall be as required by the instrumentation equipment supplied under another section.

The loop power supply shall be separate from the power supply circuit for the processor and racks.

The power source for all digital inputs from field devices shall be separately fused for each digital

input module. Unless otherwise noted, all field devices will be provided with dry contacts that close to provide an input to the PLC.

2-1.07. Appurtenances. The PLC processor and I/O hardware shall be provided as complete systems, as shown on the block diagram drawings. The PLCs shall include all necessary hardware and software for a complete working system. All special rack or panel mounted power supplies, special interconnecting and programming cables, special grounding hardware, or isolation devices shall be furnished for proper operation of the equipment. Signal converters, signal boosters, amplifiers, special power supplies, special cable, special grounding, intrinsically safe relays and current repeaters, surge suppression devices, and isolation devices shall be furnished and installed for proper operation of the equipment.

2-1.08. Service Conditions. PLCs will be installed in air conditioned rooms.

2-2. LARGE PLC PROCESSOR. Not used.

2-3. MINI PLC PROCESSOR. The programmable logic controller processor shall be an industrial type that utilizes battery-backed CMOS type or nonvolatile type memory. Battery-backed memory shall include integral batteries with sufficient capacity for at least 6 months' memory retention without power to the processing unit. Standby and shelf life of the batteries shall be at least 5 years.

2-3.01. Diagnostics. The processor shall utilize self-monitoring diagnostic techniques. Easily visible LEDs shall indicate "run" and "halt" status as well as memory and input/output error conditions. Diagnostic codes shall also be available through the programming device to facilitate troubleshooting.

2-3.02. Programming Port. The processor shall include a programming port that is available for programming and monitoring on-line after the system is fully functional.

2-3.03. Communications. The processor shall be programmed to operate autonomously, regardless of communications status with other units.

2-3.04. Environment. The processor shall be suitable for operation in the environments specified in another section. A key switch shall be provided on the processor to select the operating mode and as a security measure.

2-3.05. Programming. The processor shall be programmable using conventional relay ladder logic, or as required, and shall include the following functions and features.

Contacts, coils, branching.

Data comparisons.

On-delay and off-delay timers.

Counters with comparators.

Floating Point Math and Logical instructions.

Master control relay.

Transitional or one-shot outputs.

Standard and user-defined data tables for digital and analog value storage.

2-3.06. Capabilities. The processor shall include the following capabilities for programming, debug of programs, and troubleshooting.

Off-line programming.

On-line status of coils and registers.

Input/output forcing.

2-3.07. Configuration. Processors shall be configured for din rail mounting. Each programmable logic controller shall include integral communications ports for the programming device, remote input/output, HMI device, or remote communications interfaces as required.

Programmable logic controller systems shall support the following types of input/output.

24 volt dc digital input and output.

4-20 mA dc analog input and output.

2-3.08. Input/Output Hardware. Input/output hardware shall be supplied in standard modules of 4, 8, 16, or 32 points each for assembly in local and remote input/output enclosures.

All input/output hardware shall be entirely contained within the PLC enclosure.

Programmable logic controllers having fixed, non-removable input/output hardware are acceptable.

All digital input/output hardware shall include isolation against surges of at least 1500 volts. All output hardware connected to inductive loads shall be supplied with surge suppression devices as required and recommended by the PLC manufacturer to prevent damage to output hardware. Combination input/output modules will be acceptable if they meet all of the requirements in the following subparagraphs.

2-3.08.01. Wiring Terminals. Input/output modules shall utilize easily removable plug-in or hinged field wiring terminals to allow removal of modules without disconnecting individual wires when available.

2-3.08.02. I/O Circuit Power Supply. Outputs for motor driven equipment will typically be powered from the driven equipment. Digital outputs for miscellaneous equipment shall be powered either from the controlled equipment or the PLC enclosure as indicated on the drawings or as coordinated with the controlled equipment supplier.

Outputs that control process equipment specified under other sections or provided under other contracts shall be fully isolated or shall operate relay-type digital output modules or interposing relays in the PLC cabinet.

2-3.08.03. Digital Input Modules. Digital input modules shall sense voltages between 20 and 28

volts dc and shall have LED indicators for each point to display the status of the field contact. Each input module shall be suitable for being connected to a separate voltage source and return. Return voltage may be common to the entire input module. Digital input modules shall provide complete electrical isolation between individual inputs.

2-3.08.04. Digital Output Modules. Digital output modules shall control voltages from 100 and 130volts ac or 20 and 28 volts dc and shall be rated at least 1 ampere. Outputs shall be individually fused and shall have LED indicators to display output status. Each digital output shall be provided with an interposing relay. Outputs shall withstand a surge of at least 80 amperes for one cycle and shall have an off-state leakage current not to exceed 2.0 mA.

2-3.08.05. Relay Digital Output Modules. Not used.

2-3.08.06. Analog Input Modules. Analog input modules shall accept linear 4-20 mA dc signals from field transmitters. Input circuitry shall be floating differential type designed to prevent loop grounding. Analog to digital conversion accuracy shall be at least 12 bit (0-4095 count) resolution. Where analog input signals are grounded outside of the PLC enclosure, isolation shall be provided for the associated analog input point either on the analog input module or through an I/I signal isolator provided in the PLC enclosure.

2-3.08.07. Analog Output Modules. Analog output modules shall transmit linear 4-20 mA dc signals to field devices. Loop power for all analog outputs shall be provided by regulated power supplies in each input/output enclosure and shall be capable of driving a 0 to 500 ohm load. Digital to analog conversion accuracy shall be at least 12 bit (0-4095 count) resolution.

2-3.08.08. Panel Terminations. All PLC input/output signals for field connections shall be terminated through panel enclosure terminal strips. Direct connection of field wiring to the I/O module terminals is not acceptable.

2-4. COMMUNICATIONS. Each programmable controller system shall be furnished complete with communication hardware RS-485 serial communications.

Communication hardware shall be compatible with the cable, data highway, fiber optic, or radio communication media.

2-4.01. Addressability. Each programmable logic controller shall be individually addressable so that only the selected controller responds when queried. At least 64 distinct network addresses shall be available. Designation of a controller's network address may be either a software or hardware function.

2-4.02. Communications Hardware. System Supplier shall provide all necessary communications hardware. Hardware shall be included for, but not be limited to, remote I/O, data highway, host computer, fiber optics, Ethernet and radio.

2-4.02.01. PLC to PLC Communications Hardware. Not used.

2-4.02.02. PLC to Remote Communications Hardware. Not used.

2-4.02.03. PLC to Host Communications Hardware. Not used.

2-4.03. Communications Media. System Supplier shall provide all necessary cabling for the PLC communications and RS-232 to RS-485 conversion. Communications cables shall meet the requirements of the manufacturers of the PLCs and communications modules.

2-5. PROGRAMMING DEVICE HARDWARE. The programming device shall be a portable notebook computer. System Supplier shall provide two interconnecting cables, each 5 meters long, to connect the computer to the programmable logic controller. The cables shall be shielded data cable and shall be terminated on both ends with the appropriate connectors. Connectors shall be labeled to identify the connected equipment.

2-5.01. Special Devices. System Supplier shall provide two sets of any special devices (such as null modems, adapter cards, interface converters, etc.) required to establish an operational programming line between the programmable logic controllers and programming device.

2-6. PROGRAMMING SOFTWARE. System Supplier shall furnish one licensed copy of PLC programming software for the Owner. The software shall be suitable for running on a laptop computer running Windows XP operating system software. A full legal set of programming software documentation shall accompany each copy of the software. Each copy of the programming software shall include all necessary device drivers and add-on software packages.

2-6.01. Standard Product. The programming software shall be personal computer based and a standard product of the PLC manufacturer.

2-6.02. PLC Simulation. Not used.

2-6.03. Programming Software Features. The programming software shall allow off-line development of all PLC-related programming, including user annotation of the program, and creation and printing of application programs and I/O cross-reference lists. Special programming tasks originally provided by System Supplier shall also be included.

On-line features shall include IEC-1311 standards program modification, ladder-logic modification, program language modification, monitoring of real-time ladder-logic execution, monitoring of program execution, monitoring and manipulation of timer and counter preset and present values, monitoring and forcing of physical I/O, and monitoring and manipulation of analog (register) and bit (binary) data table values. PLC and I/O hardware diagnostic and status information shall be accessible using the software in on-line mode.

2-6.04. Local Operator Interface. The PLC shall include a local touchscreen operator interface configured and programmed to monitor and control all application functions configured in the PLC. The LOI displays shall be arranged and configured according to the process functionality required for the PLC application. CONTRACTOR shall submit for approval to ENGINEER and OWNER LOI display layout and configuration. LOI shall be SIMATIC TP 270-10 or pre-approved equal. Licensed configuration software as well as backup copies of all configured screens shall be turned over to the Owner upon completion of the project. LOI shall be mounted on the front of the new PLC enclosure per Section 13570 2-2.

2-6.05. Uninterruptible Power Supply (UPS).

- a. Panels shall be provided with a UPS to provide power to the PLC microprocessor and PLC support, interface and communication equipment for 30 minutes upon failure of local power and to provide non- interruptible transfer when power source is switched to from utility to local generator and back.
- b. A UPS is not required for local backup control panel.
- c. UPS shall provide full time EMI/RFI filtering and clamping response time shall be less than five nanoseconds.
- d. Provide visual UPS “on” and “fault” indicators. Provide audible “on battery”, “low battery” and “overload” indicators.
- e. Provide internal “on-battery” current limiting and “on-line” circuit breaker for UPS overload protection.

2-7. SYSTEM ENCLOSURES. Programmable logic controllers and input/output hardware shall be housed in shop-assembled panels as indicated on the drawings and as described in the Panels, Consoles, and Appurtenances section.

PART 3 - EXECUTION

3-1. INSTALLATION REQUIREMENTS. PLCs installation requirements are specified in Instrumentation and Control System section except as described herein.

Field check, testing, and training shall be as specified in the Instrumentation and Control System section.

3-2. CONFIGURATION.

3-2.01. PLC Programming and Configuration. Configuration services are specified in the Instrumentation and Control System section.

3-2.02. Communications Configuration. The communications shall be fully configured and installed by System Supplier, and shall be operational before application software configuration by others. .

End of Section

This page was left blank intentionally

Input/Output List - Legend/Description Sheet

Item. This is an arbitrary sequential number which is for reference only.

Panel ID. This is the panel identification for the I/O cabinet, PLC cabinet, or controller where the I/O signal terminates.

Type: This is the type of I/O signal, as follows:

AI = Analog Input

AO = Analog Output

DI = Discrete Input

DO = Discrete Output

PI = Pulse Input (totalizer or accumulator type input)

Point. This is the type point number.

Service Description. This is the description or the function (i.e. Filter No. 1 Loss-of-Head).

Field Device. This is the tag number of equipment identifier associated with the I/O point.

Analog Data (Signal Type). This will typically be 4-20mA, but could also be 1-5Vdc, serial, HART, FLD-BUS, or similar to indicate the signal type of the associated input or output.

Analog Data (Calibrated Range). This will be the scaled value of the input in engineering units.

Analog Data (Power). This will typically be '2-wire' for devices which are loop powered from the PLC enclosure, or '4-wire' for devices which are powered from external power supplies, unless noted otherwise.

Discrete Data (Signal Type). This will be 120VAC, 24VDC, or similar to indicate the signal type of the associated input or output.

Discrete Data (Closed State). This will indicate the state of the input or output when it is considered to be closed or energized (normal, alarm, running, failed, etc.).

Discrete Data (Power Source). This will indicate the location of the power source for the wetting voltage on the contacts, as follows:

Field = External field power source. (May require interposing relays or isolated I/O module type.)

Local = Power originates from within the PLC or I/O enclosure.

Discrete Data (Interp Relay). This will be either 'Yes' or 'No' to indicate whether the input or output requires an interposing relay. Relays are typically required to isolate external voltage sources. See specifications for additional details.

Comments/Notes This column may include a cross reference to another specification section where applicable, or to a note which provides additional information. Notes are appended to the end of the I/O listing.

Item	Panel ID	Type	Service Description	Field Device	Analog Data			Discrete Data				Comments/Notes
					Signal Type	Calibrated Range	Power	Signal Type	Closed State	Power Source	Interp Relay	
1	3151	AI	FUEL TANK LEVEL	FUEL TANK	4-20 mA		4-WIRE				No	
2	3151	AI	PUMP 1 SPEED IN	AFD 1	4-20mA	0-100%	4-WIRE					
3	3151	AI	PUMP 2 SPEED IN	AFD 2	4-20mA	0-100%	4-WIRE					
4	3151	AI	PUMP 3 SPEED IN	AFD 3	4-20mA	0-100%	4-WIRE					
5	3151	AI	PUMP 4 SPEED IN	AFD 4	4-20mA	0-100%	4-WIRE					
6	3151	AI	PUMP 5 SPEED IN	AFD 5	4-20mA	0-100%	4-WIRE					
7	3151	AI	PUMP 6 SPEED IN	AFD 6	4-20 mA	0-100%	4-WIRE				No	
8	3151	AI	STATION FLOW	FIT-3151-01	4-20 mA	0-6750 GPM	4-WIRE					
9	3151	AI	STATION PRESSURE	PIT-3151-01	4-20 mA	0-100 PSI	2-WIRE					
10	3151	AI	WETWELL 1 LEVEL	LT-3151-11	4-20 mA	0-23 FT	2-WIRE					INTRINSICALLY SAFE
11	3151	AI	WETWELL 2 LEVEL	LT-3151-12	4-20 mA	0-23 FT	2-WIRE					INTRINSICALLY SAFE
12	3151	AO	PUMP 1 SPEED OUT	AFD 1	4-20mA	0-100%	4-WIRE					
13	3151	AO	PUMP 2 SPEED OUT	AFD 2	4-20mA	0-100%	4-WIRE					
14	3151	AO	PUMP 3 SPEED OUT	AFD 3	4-20mA	0-100%	4-WIRE					
15	3151	AO	PUMP 4 SPEED OUT	AFD 4	4-20mA	0-100%	4-WIRE					
16	3151	AO	PUMP 5 SPEED OUT	AFD 5	4-20mA	0-100%	4-WIRE					
17	3151	AO	PUMP 6 SPEED OUT	AFD 6	4-20 mA	0-100%	4-WIRE					
18	3151	DI	BUILDING HIGH TEMPERATURE	YS-3151-20				DRY CONTACT	HIGH TEMPERATURE	LOCAL	No	
19	3151	DI	BUILDING INTRUSION	ZS-3151-20A				DRY CONTACT	BUILDING INTRUSION	LOCAL	NO	
20	3151	DI	COMPUTER/LOCAL CONTROL	HS-3151-20				DRY CONTACT	COMPUTER	LOCAL	NO	

Item	Panel ID	Type	Service Description	Field Device	Analog Data			Discrete Data				Comments/Notes
					Signal Type	Calibrated Range	Power	Signal Type	Closed State	Power Source	Interp Relay	
21	3151	DI	EMERGENCY SOURCE	ATS				DRY CONTACT	EMERGENCY SOURCE	LOCAL	No	
22	3151	DI	FUEL TANK ALARM	FUEL TANK				DRY CONTACT	FAIL	LOCAL	No	
23	3151	DI	GENERATOR ALARM	ENGINE				DRY CONTACT	GENERATOR FAIL	LOCAL	No	
24	3151	DI	GENERATOR RUNNING	ENGINE				DRY CONTACT	RUNNING	LOCAL	No	
25	3151	DI	LAG 2 FLOAT	LS-3151-11E				DRY CONTACT	TIPPED	LOCAL	YES	INTRINSICALLY SAFE RELAY
26	3151	DI	LAG 3 FLOAT	LS-3151-11F				DRY CONTACT	TIPPED	LOCAL	YES	INTRINSICALLY SAFE RELAY
27	3151	DI	LAG 4 FLOAT	LS-3151-11G				DRY CONTACT	TIPPED	LOCAL	YES	INTRINSICALLY SAFE RELAY
28	3151	DI	LAG 5 FLOAT	LS-3151-11H				DRY CONTACT	TIPPED	LOCAL	YES	INTRINSICALLY SAFE RELAY
29	3151	DI	LAG FLOAT	LS-3151-11D				DRY CONTACT	TIPPED	LOCAL	YES	INTRINSICALLY SAFE RELAY
30	3151	DI	LEAD FLOAT	LS-3151-11C				DRY CONTACT	TIPPED	LOCAL	YES	INTRINSICALLY SAFE RELAY
31	3151	DI	LOW FLOAT	LSLL-3151-11A				DRY CONTACT	TIPPED	LOCAL	YES	INTRINSICALLY SAFE RELAY
32	3151	DI	NORMAL SOURCE	ATS				DRY CONTACT	NORMAL SOURCE	LOCAL	No	
33	3151	DI	ODOR CONTROL GENERAL TROUBLE	ODOR CONTROL PANEL				DRY CONTACT	FAIL	LOCAL	No	
34	3151	DI	ODOR CONTROL RUNNING	ODOR CONTROL PANEL				DRY CONTACT	RUNNING	LOCAL	No	
35	3151	DI	OFF FLOAT	LS-3151-11B				DRY CONTACT	OFF	LOCAL	YES	INTRINSICALLY SAFE RELAY
36	3151	DI	OVERRIDE HIGH FLOAT	LSHH-3151-10A/B				DRY CONTACT	HIGH	LOCAL	YES	INTRINSICALLY SAFE RELAY
37	3151	DI	PANEL INTRUSION	RTU				DRY CONTACT	RTU PANEL INTRUSION	LOCAL	NO	
38	3151	DI	POWER FAILURE RTU PANEL	RTU				DRY CONTACT	POWER FAILURE RTU	LOCAL	NO	
39	3151	DI	PUMP 1 RVSS/AFC MODE	AFD-1				DRY CONTACT	AFC	LOCAL	No	
40	3151	DI	PUMP 1 FAIL AFD	AFD-1				DRY CONTACT	FAIL	LOCAL	No	
41	3151	DI	PUMP 1 HOA AFD AUTO	AFD-1				DRY CONTACT	AUTO	LOCAL	No	
42	3151	DI	PUMP 1 HOA AFD HAND	AFD-1				DRY CONTACT	HAND	LOCAL	No	
43	3151	DI	PUMP 1 RUN RVSS	AFD-1				DRY CONTACT	RVSS	LOCAL	No	
44	3151	DI	PUMP 1 RUNNING AFD	AFD-1				DRY CONTACT	RUNNING	LOCAL	No	
45	3151	DI	PUMP 1 RVSS FAIL	AFD-1				DRY CONTACT	FAIL	LOCAL	No	
46	3151	DI	PUMP 2 RVSS/AFC MODE	AFD-2				DRY CONTACT	AFC	LOCAL	No	
47	3151	DI	PUMP 2 FAIL AFD	AFD-2				DRY CONTACT	FAIL	LOCAL	No	
48	3151	DI	PUMP 2 HOA AFD AUTO	AFD-2				DRY CONTACT	AUTO	LOCAL	No	
49	3151	DI	PUMP 2 HOA AFD HAND	AFD-2				DRY CONTACT	HAND	LOCAL	No	
50	3151	DI	PUMP 2 RUN RVSS	AFD-2				DRY CONTACT	RVSS	LOCAL	No	
51	3151	DI	PUMP 2 RUNNING AFD	AFD-2				DRY CONTACT	RUNNING	LOCAL	No	
52	3151	DI	PUMP 2 RVSS FAIL	AFD-2				DRY CONTACT	FAIL	LOCAL	No	
53	3151	DI	PUMP 3 RVSS/AFC MODE	AFD-3				DRY CONTACT	AFC	LOCAL	No	
54	3151	DI	PUMP 3 FAIL AFD	AFD-3				DRY CONTACT	FAIL	LOCAL	No	

Item	Panel ID	Type	Service Description	Field Device	Analog Data			Discrete Data				Comments/Notes
					Signal Type	Calibrated Range	Power	Signal Type	Closed State	Power Source	Interp Relay	
55	3151	DI	PUMP 3 HOA AFD AUTO	AFD-3				DRY CONTACT	AUTO	LOCAL	No	
56	3151	DI	PUMP 3 HOA AFD HAND	AFD-3				DRY CONTACT	HAND	LOCAL	No	
57	3151	DI	PUMP 3 RUN RVSS	AFD-3				DRY CONTACT	RVSS	LOCAL	No	
58	3151	DI	PUMP 3 RUNNING AFD	AFD-3				DRY CONTACT	RUNNING	LOCAL	No	
59	3151	DI	PUMP 3 RVSS FAIL	AFD-3				DRY CONTACT	FAIL	LOCAL	No	
60	3151	DI	PUMP 4 RVSS/AFC MODE	AFD-4				DRY CONTACT	AFC	LOCAL	No	
61	3151	DI	PUMP 4 FAIL AFD	AFD-4				DRY CONTACT	FAIL	LOCAL	No	
62	3151	DI	PUMP 4 HOA AFD AUTO	AFD-4				DRY CONTACT	AUTO	LOCAL	No	
63	3151	DI	PUMP 4 HOA AFD HAND	AFD-4				DRY CONTACT	HAND	LOCAL	No	
64	3151	DI	PUMP 4 RUN RVSS	AFD-4				DRY CONTACT	RVSS	LOCAL	No	
65	3151	DI	PUMP 4 RUNNING AFD	AFD-4				DRY CONTACT	RUNNING	LOCAL	No	
66	3151	DI	PUMP 4 RVSS FAIL	AFD-4				DRY CONTACT	FAIL	LOCAL	No	
67	3151	DI	PUMP 5 RVSS/AFC MODE	AFD-5				DRY CONTACT	AFC	LOCAL	No	
68	3151	DI	PUMP 5 FAIL AFD	AFD-5				DRY CONTACT	FAIL	LOCAL	No	
69	3151	DI	PUMP 5 HOA AFD AUTO	AFD-5				DRY CONTACT	AUTO	LOCAL	No	
70	3151	DI	PUMP 5 HOA AFD HAND	AFD-5				DRY CONTACT	HAND	LOCAL	No	
71	3151	DI	PUMP 5 RUN RVSS	AFD-5				DRY CONTACT	RVSS	LOCAL	No	
72	3151	DI	PUMP 5 RUNNING AFD	AFD-5				DRY CONTACT	RUNNING	LOCAL	No	
73	3151	DI	PUMP 5 RVSS FAIL	AFD-5				DRY CONTACT	FAIL	LOCAL	No	
74	3151	DI	PUMP 6 RVSS/AFC MODE	AFD-6				DRY CONTACT	AFC	LOCAL	No	
75	3151	DI	PUMP 6 FAIL AFD	AFD-6				DRY CONTACT	FAIL	LOCAL	No	
76	3151	DI	PUMP 6 HOA AFD AUTO	AFD-6				DRY CONTACT	AUTO	LOCAL	No	
77	3151	DI	PUMP 6 HOA AFD HAND	AFD-6				DRY CONTACT	HAND	LOCAL	No	
78	3151	DI	PUMP 6 RUN RVSS	AFD-6				DRY CONTACT	RVSS	LOCAL	No	
79	3151	DI	PUMP 6 RUNNING AFD	AFD-6				DRY CONTACT	RUNNING	LOCAL	No	
80	3151	DI	PUMP 6 RVSS FAIL	AFD-6				DRY CONTACT	FAIL	LOCAL	No	
81	3151	DI	STATION POWER FAIL	ATS				DRY CONTACT	STATION POWER FAIL	LOCAL	No	
82	3151	DI	WELL 1 HI HI FLOAT	LSHH-3151-11J				DRY CONTACT	HIGH HIGH	LOCAL	No	INTRINSICALLY SAFE
83	3151	DI	WELL 2 HI HI FLOAT	LSHH-3151-12J				DRY CONTACT	HIGH HIGH	LOCAL	No	INTRINSICALLY SAFE
84	3151	DO	PLC FAIL	BFCP				DRY CONTACT	PLC OK	LOCAL	YES	DEENERGIZE FAIL
85	3151	DO	PUMP 1 START/STOP AFD	AFD-1				DRY CONTACT	START	LOCAL	YES	
86	3151	DO	PUMP 2 START/STOP AFD	AFD-2				DRY CONTACT	START	LOCAL	YES	
87	3151	DO	PUMP 3 START/STOP AFD	AFD-3				DRY CONTACT	START	LOCAL	YES	
88	3151	DO	PUMP 4 START/STOP AFD	AFD-4				DRY CONTACT	START	LOCAL	YES	
89	3151	DO	PUMP 5 START/STOP AFD	AFD-5				DRY CONTACT	START	LOCAL	YES	
90	3151	DO	PUMP 6 START/STOP AFD	AFD-6				DRY CONTACT	START	LOCAL	YES	
91	3151	DI	ODOR FAN MOTOR FAILURE	ODOR CONTROL PANEL				DRY CONTACT	FAIL	LOCAL	No	
92	3151	DI	ODOR CONTROL FAN RUNNING	ODOR CONTROL PANEL				DRY CONTACT	RUNNING	LOCAL	No	
93	3151	DI	MIST ELIMINATOR HIGH DIFFERENTIAL PRESSURE	ODOR CONTROL PANEL				DRY CONTACT	HIGH DP	LOCAL	No	
94	3151	DI	RECIRCULATION PUMP FAILURE, (RECYCLE-TYPE SYSTEM ONLY)	ODOR CONTROL PANEL				DRY CONTACT	FAIL	LOCAL	No	
95	3151	DI	RECIRCULATION PUMP RUNNING	ODOR CONTROL PANEL				DRY CONTACT	RUNNING	LOCAL	No	

THIS PAGE LEFT BLANK INTENTIONALLY

RADIO EQUIPMENT

PART 1 - GENERAL

1-1. SCOPE. This section covers the furnishing of radio communication equipment for the Instrumentation and Control System. Radio equipment shall operate in conjunction with field devices such as PLCs,, as described elsewhere in these specifications. The radio equipment shall consist of remote radios.

1-1.02. Control System. The Instrumentation and Control System section shall apply to all equipment furnished under this section.

1-2. GENERAL. Equipment furnished and under this section shall be fabricated, assembled, erected, and placed in proper operating condition in full conformity with the drawings, specifications, engineering data, instructions, and recommendations of the equipment manufacturer, unless exceptions are noted by the Engineer.

1-2.01. General Equipment Stipulations. The General Equipment Stipulations shall apply to all equipment provided under this section. If requirements in this specification differ from those in the General Equipment Stipulations, the requirements specified herein shall take precedence.

1-2.02. Drawings. All hardware, including power supplies, special cables, and other appurtenant equipment, shall be provided to meet the functional requirements described herein and indicated on the drawings.

1-2.03. Accessories. System Supplier shall provide all necessary equipment such as channel processors, line buffers, communication couplers, and modems, to transmit commands and receive data via communication channels. System Supplier shall also provide all radio transmitters, receivers, antennas, cabling, and mounting hardware for a complete operational radio system.

1-3. SUBMITTALS. Submittals shall be as specified in the Instrumentation and Control System section.

1-4. DELIVERY, STORAGE, AND SHIPPING. Delivery, storage and shipping shall be as specified in the Instrumentation and Control System section.

PART 2 - PRODUCTS

2-1. SERVICE CONDITIONS. Radios and accessories shall be suitable for installation in enclosures and for environmental conditions as follows.

<u>Radio Type</u>	<u>Tag</u>	<u>Enclosure</u>	<u>Service Conditions</u>
Remote radios	PS-3151	Mounted in	Air-conditioned room

enclosure with
other equipment

2-2. SPREAD SPECTRUM RADIO – Serial Communications. Not used.

2-3. SPREAD SPECTRUM RADIO – Ethernet Communications. Not used.

2-4. MAS RADIO.

2-4.01. MAS Radio General Characteristics. The MAS radio general characteristics shall be as follows:

MAS Remote Radio

Number of channels (per radio)	1
Frequency Selection	928/952 MHz
Number of channels (per radio)	1
Frequency Selection	928/952 MHz
Signal Modulation	FM
Modulation Deviation	±3 kHz
S/N (flat weighing) 15 dBm threshold at antenna port (3 kHz channel)	-104 dBm S/N
Antenna Gain (dB)	9 (existing)
Vertical Beamwidth	43 degrees (existing)
Type of Antenna	Yagi (existing)
Communications Data Baud Rate	Utilities standard

2-4.02. Communication Channel. Radios indicated on the drawings or specified herein shall utilize frequency modulated, radio frequency as its communications medium.

System transceivers shall operate on a dedicated channel pair in the 950 MHz band in conformance with FCC Rules and Regulations, Parts 22 and 101. Bandwidth shall be 12.5 kHz.

2-4.03. System Equipment. MAS radio transceivers shall be MDS 9710B without exception.

2-4.04. Digital Interface. The digital interface shall have the following characteristics.

2-4.04.01. Field Interface Devices. Interface shall be EIA RS-232 consistent with the remote terminal units furnished herein.

2-4.04.02. RTS/CTS. Interface shall support RTS/CTS handshaking. CTS shall be granted within 10 msec after RTS. Bit Error Rate shall be 1×10^{-6} or better at -111 dBm, KBPS.

2-4.05. Power Requirements. The MAS radio shall be designed for continuous operation on a nominal 12 VDC source.

2-4.06. Diagnostic Indicators. The MAS remote radios shall have at least the following indicators for local indication.

Request to Send
Clear to Send
Carrier Detect
Transmit Data
Receive Data

2-4.07. Radio System Diagnostics. The MAS radios shall include system diagnostics to permit continuous or scheduled automatic monitoring of key operating parameters and alarm conditions.

2-4.07.01. Communication. The diagnostic package shall communicate data from all remote transceiver radios in the system to the base radio and polling remote radio via the radio's RF channel.

2-4.07.02. Radio Diagnostic Software. Not used.

2-4.07.02.01. Diagnostic Data. Diagnostic data transmitted over the radio frequency channel must use dual tone multi-frequency encoding to eliminate the possibility of diagnostic information being misinterpreted as data being sent from the SCADA system.

2-4.07.03. Programming Device Hardware. Not used.

2-4.07.04. Special Devices. System Supplier shall provide two sets of any special devices (such as null modems, adapter cards, interface converters, etc.) required to establish an operational programming line between the radios and programming device.

2-4.07.05. Base Radio or Polling Remote Radio Diagnostic Data/Control Functions. Not used.

2-4.07.05.01. Control and Display Capability. Not used.

2-4.07.06. Remote Transceiver Radio Diagnostic Data/Control Functions. Not used.

2-4.07.07. Remote Transceiver Hand-Held Programmer/Test Set. Not used.

2-5. SURGE SUPPRESSION. System Supplier shall provide an in-line surge suppressor on antenna cables at each radio site to protect the radio equipment from damage by lightning. Surge suppressors shall be Polyphaser Series IS-B50LN-C2 or equal.

Two lengths of superflexible Heliac cable shall be supplied for each surge suppressor; one for the connection between surge suppressor and radio antenna port, and one for the connection between the coaxial transmission cable (1/2 inch and larger) and the antenna. The cable shall be terminated with standard N type connectors. The cable shall be Andrew Superflexible Heliac 1/4 inch Type FSS1-50A.

2-6. ANTENNAS. System Supplier shall reuse the antennas and supporting structures at Pump Stations 3151.

2-6.01. Omnidirectional Antennas. Not used.

2-6.02. Directional Antennas. Not used.

2-6.03. Wooden Poles. Not used.

2-6.04. Radio Towers. Not used.

2-6.05. Radio Masts. Not used.

2-6.06. Grounding Conductors. All ground conductors shall be soft drawn copper cable or bar, not smaller than 12 AWG, bare or green insulated in accordance with the National Electrical Code.

2-6.07. Ground Rods. Ground rods not described elsewhere shall be 5/8 inch diameter by 8 feet long, with a copper jacket bonded to a steel core.

2-6.08. Ground Kits. Two ground kits shall be supplied that meets MIL-STD_188_124A "Military Standard for Grounding, Bonding and Shielding" bond resistance requirement of a maximum DC resistance of 0.001 Ohm's and IEC 1024-1 "Protection of Structures Against Lightning" requirements of 16 mm² cross-sectional area for copper bonding conductors. The kit shall be designed to withstand over 100,000 amps peak current surge in accordance to MIL-STD_1757, Test Method T02, Current Component A, using a damped oscillatory type waveform. Kits shall be Andrews SureGroundTM and no other.

2-6.09. Antenna Cable. Coaxial transmission cable shall be furnished that will connect each radio with the antenna and shall be low loss, foam filled dielectric type. Coaxial cable shall be 1/2" with a minimum bend radius of 5 inches for installations under 100 feet and 7/8" with a minimum bend radius of 10 inches for installations over 100 feet. The cable shall be Andrew Superflexible Heliac.

2-6.10. Hanger Kits. Hanger kits shall be provided appropriate for the towers being reused and shall be installed every three feet.

PART 3 - EXECUTION

3-1. GENERAL INSTALLATION REQUIREMENTS. General installation requirements are described in Section 13500.

3-1.01. Radio Equipment. The radio equipment shall be mounted in field device enclosures or in a separate enclosure as specified herein. Separate enclosures shall be furnished with the same NEMA rating and color as the field device enclosure.

3-1.02. Radio Signal Strength Testing. Not used.

3-1.03 Functional Testing. As a minimum, the following functional tests shall be performed on the communications equipment.

3-1.03.01. Antenna Alignment. After each antenna is permanently installed, a power monitor shall be used to properly adjust the antenna for maximum signal strength. A written report on the monitoring results shall be submitted to the Engineer for review before the radios are placed into permanent operation.

3-1.03.02. Radio Frequency Check. After each radio has been installed but before it is placed into permanent operation, a frequency check shall be conducted to verify conformance with the specified tolerances. The frequency check shall be performed by a radio technician either employed or under subcontract to System Supplier. A written report on the results of this check shall be submitted to the Engineer for acceptance.

3-1.04. Surge Suppressor Installation. Surge suppressors shall be bulkhead mounted on the radio enclosures and shall be suitable for the sizes of cable inside and outside the enclosures.

3-1.05. Installation of Grounding Materials. Electrical system grounding and equipment grounding shall be in compliance with the National Electrical Code.

3-1.06. Antenna Installation. The Contractor shall supervise the reinstallation of antenna equipment at Pump Station 3151.

3-2. FCC LICENSE. One or more frequency licenses has been granted to the Owner by the FCC. The licensed frequencies and their effective dates are as specified.

End of Section

THIS PAGE LEFT BLANK INTENTIONALLY

SOFTWARE CONTROL BLOCK DESCRIPTIONS

PART 1 - GENERAL

1-1. SCOPE. This section provides functional descriptions of the PLC and computer software requirements for the Instrumentation and Control System as indicated on the drawings. These descriptions are intended to provide an overview of the operating concept of the pump station process equipment rather than describing in detail every operating feature or interlock.

1-1.01. Control System. The Instrumentation and Control System section shall apply to all systems described in this section.

PART 2 – PRODUCTS

2-1. GENERAL. The descriptions are applicable to the software specified in the Programmable Logic Controller section.

PART 3 - EXECUTION

3-1. PLC PROGRAMMING FUNCTIONAL REQUIREMENTS. The following paragraphs describe general configuration tasks that are required for the system PLC(s). These tasks shall be programmed in any applicable PLC. Each PLC may have multiple instances of each of these tasks, or may have no instances of some or all of these tasks. The input/output lists (located in these documents as specified in the Instrumentation and Control System section) and detailed equipment control descriptions (included herein) should be referenced to determine the requirements for each PLC.

The following paragraphs cover functional requirements of the software, which are generic and may or may not be related to any specific control loop.

3-1.01. Available Process Values. All PLC-generated process alarm, equipment status, and process variable values shall be available to the Master polling device.

3-1.02. Flow Values. Flow values shall be integrated, totalized, scaled and stored in the PLC registers so the values displayed on the HMI computers and on the field processor will be identical.

3-1.03. System Failure. Failure of a PLC shall result in safe shutdown of associated process equipment. Interposing relays shall be provided where required to assure that equipment will revert to its fail-safe condition. Failure of any PLC or its communication shall be alarmed on the HMI computer.

3-1.04. HMI Computers. The HMI computers shall function as a monitoring system, not as a controller, for the process equipment. The computer shall download set points and other

information to the PLCs, and the PLCs shall perform all control algorithms, so a temporary failure of the any HMI computer will not disrupt the pump station control.

3-1.05. Rack/Module Configuration. The rack and module definitions for each PLC, as well as the PLC communications configuration shall be completely configured to allow proper addressing of all field connected I/O points.

3-1.06. PLC Database Definition. The PLC database will include both field I/O points and internally generated points required for programming. All field I/O points and internal programming points shall be fully defined according to database naming conventions approved by Owner. As a minimum, each database point shall be provided with a tag name, engineering unit, alarm parameters, and description.

3-1.07. Analog Scaling. Each analog input and output will be appropriately scaled for use in internal PLC programming, monitoring by the HMI computers, or transmission to other PLCs. Requirements for raw count values shall be coordinated with the operator interface software to ensure compatibility.

3-1.08. Equipment Runtimes. For each equipment item whose "run" status is monitored by a PLC, an internal equipment runtime shall be accumulated by the respective PLC. The runtime procedure will monitor the status of the equipment "run" contact and, when the equipment is running, increment a software timer that maintains equipment runtime to within a one-minute resolution. The timer shall stop incrementing, but not reset, when the "run" contact indicates that the equipment is not running. The timer value shall increment an hour counter that maintains an integer value representing the equipment run time in hours. The counter value shall be available for display on the HMI computer. A manual reset of the runtime value shall be available at the HMI computers for personnel at the supervisor level and above.

3-1.09. Change-of-State Alarms. While equipment is controllable from the PLC ("in remote"), discrete output commands shall be compared to their respective process feedback status signal (where available) to verify proper execution. If the feedback status does not match the most recent output command (after an adjustable 2 to 300 second time delay), an alarm message shall be displayed on the HMI computer and the condition shall be logged as an alarm, requiring operator acknowledgment. The alarm shall remain energized until the proper discrete condition is sensed or until the operator resets the alarm through the HMI computer.

3-1.10. Equipment Availability. In general, equipment with PLC control has been provided with a local selector switch that transfers control to the PLC. The PLC shall monitor the position of this switch to determine if the equipment is available for PLC control. If the equipment is not available, the PLC program shall not attempt to implement remote manual or automatic status changes for the equipment. The PLC program may, however, need to implement special routines if equipment unavailability affects a sequence (as described in the detailed equipment descriptions).

3-1.11. Maintained/Momentary Outputs. The need for maintained or momentary control outputs shall be determined from the input/output listing and the electrical schematics. In general, equipment with only one control output indicated in the I/O list shall be programmed for a maintained control output. Equipment with two (or more) control outputs shall be programmed for momentary outputs. Provisions shall be made, in either case, to remove the active state (start,

open, forward, initiate, etc.) control output when an equipment failure is sensed or when the equipment transitions from available to unavailable (local switch change).

3-1.12. Equipment Mode Changes. Unless otherwise indicated in the equipment control descriptions, equipment in automatic mode shall be transitioned to manual mode (and stopped) if the equipment fails or becomes unavailable or if the PLC processor resets.

3-1.13. Manual/Auto Bumpless Transfer. Unless otherwise indicated in the equipment control descriptions, equipment changes from automatic to manual control shall be bumpless. Equipment running or stopped in automatic mode shall remain running or stopped when manual mode is selected.

3-2. EQUIPMENT CONTROL AND CONTROL MODE OVERVIEW. The following paragraphs explain the general format and control modes that are used in the detailed equipment descriptions. These paragraphs apply to the attached, project specific, equipment control descriptions included herein.

3-2.01. General. Appended to this section are the equipment control programming requirements, with requirements for both PLC programming and the minimum operator interface functions. The HMI requirements represent the anticipated display generation requirements and shall be adjusted if the PLC programming warrants adjustment.

3-2.02. Control Modes. There are two general control modes available for the process equipment: 1) remote manual, and 2) remote auto. Remote manual control provides a means for operators to adjust equipment status or setpoint, through the HMI, using manually initiated commands. Remote automatic control provides a means for automatically changing equipment status or setpoint based on measured process parameters, calculated values, or operator setpoints. Some equipment may have more than one remote auto mode.

Descriptions for local control are included in the detailed equipment control descriptions. They are provided primarily for documentation purposes and for information. These controls are hardwired and require no programming effort.

3-3. DETAILED EQUIPMENT CONTROL DESCRIPTIONS. The following paragraphs describe specific function requirements for various software control blocks in the control system. These descriptions are intended to provide an overview of the operational concept for the facilities, rather than describing in detail every operating feature or interlock. Pump Station 3151 (Southwest) shall be wired and programmed to provide the following functionality.

3-3.01. Pump Station 3151 Wetwell Level Control. Please Note: As directed in Section 13500, the Southwest Station shall be programmed and configured as follows.

Associated Equipment

P-3151-01, P-3151-02, P-3151-03, P-3151-04, P-3151-05

Associated PLC

PLC-3151

Associated P&ID(s)

I-4

Note: The PLC shall be programmed to accomplish the control as described below.

Control Modes

In all control modes, the pump will shutdown on phase fault (as detected by the starting equipment) or pump fault (temperature, leak etc.). These interlocks are hardwired. Refer to the electrical schematics. When in Remote, the pump can be disabled by the RTU via telemetry command if the PLC is not failed or the HI HI float is not tipped (backup float panel operation).

Local Manual Mode

Local Manual control of each raw wastewater pump shall be provided through its associated AFD or Soft Starter via hand switches and push buttons resident on the individual pump control panels.

1. AFD MODE - If the Selector Switch #1 (AFD/RVSS) is placed in "AFD" and Selector Switch #2 (HOA) is placed in HAND and the momentary Start Push Button is depressed the pump shall run and pump speed shall be adjusted at the AFD. The pump shall continue to run until the momentary Stop Push Button is depressed.
2. RVSS MODE - If the Selector Switch #1 (AFD/RVSS) is placed in "RVSS" and Selector Switch #2 (HOA) is placed in HAND and the momentary Start Push Button is depressed the Soft Starter shall energize and the pump shall run in RVSS. The pump shall continue to run until the momentary Stop Push Button is depressed.

Local Auto Mode

Local Automatic control of each raw wastewater pump shall be provided by a Backup Float Control Panel (BCP) when Selector Switch #2 is in "REMOTE" and the High High Float tips or a PLC failure is detected. When Selector Switch #2 is in "OFF" or "HAND" the BCP is disabled. When Local Automatic mode is initiated, the PLC control will be disabled and the backup control panel shall control wetwell level by switching each drive lineup from AFD to RVSS (softstarts) and starting the pumps in a Lead, Lag, Lag2, Lag3 and Lag4 configuration based on the Lead, Lag, Lag2, Lag3 and Lag4 floats. No alternation of pumps is provided by the backup control panel. Pump 1 will be lead, etc. Local Automatic control shall continue until reset locally by the Operator. These controls are hardwired. Refer to the electrical schematics.

Remote Manual Mode

In remote manual mode the pumps can be started and stopped as commanded by the Operator in AFD mode only.

Remote Auto Mode

Remote auto mode shall be provided through the PLC. AFD Selector Switch #1 shall be in "AFD", Selector Switch #2 shall be in AUTO or OFF and the remote HOA switch shall be in "AUTO" before the auto sequencing shall perform. If the Selector Switch #2 is in "OFF" or the remote HOA switch is in "OFF", the pump will be dropped out of the alternation sequence. Sequencing for up to five (5) pumps shall be programmed. The operator shall select AUTO at the remote or local HMI and the pump shall be controlled by the pump station wetwell level

control system. The pump station wetwell level control system shall stage pumps to control the level in the wetwell as follows:

1. AFD MODE

A. The lead variable speed pump shall start as level in the wetwell rises to an adjustable level (operator selectable on either HMI initially set at EL 13.07 ft). The lead AFD will ramp up and down to maintain this setpoint wetwell level. If wetwell level drops below an adjustable level setpoint, operator selectable at the HMI, initially set at 0.5 foot below the setpoint level, the lead variable speed pump shall shut down.

B. If the wetwell level rises above a level setpoint (operator selectable at the HMI, initially set at 0.5 foot) above the setpoint level for lead pump operation, an adjustable timer with an initial setting of 60 seconds shall start. If the timer times out and the level still has remained above the level setpoint then the lag pump shall start. If wetwell level drops below the setpoint level by the amount established in step A, an adjustable timer initially set for 60 seconds shall start. If the timer times out and the level is still below the level setpoint, then the lag variable speed pump shall shut down, and the system shall operate as described in step A.

C. If the wetwell level rises above the setpoint level for the lag pump operation by the amount established in step B, an adjustable timer initially set at 60 seconds shall start. If the level is above the established setpoint after the timer times out then the lag2 variable speed pump shall start. All variable speed pumps shall be controlled by the wetwell level to operate at the same speed and maintain the level in the wetwell. If wetwell level drops below the setpoint level for lag2 pump operation by the amount established in step A, an adjustable timer initially set for 60 seconds shall start. If the timer times out and the level is below the established level then the lag 2 variable speed pump shall shut down and the system shall operate as described in step B.

D. If the wetwell level rises above the setpoint level for the lag2 pump operation by the amount established in step B, an adjustable timer initially set at 60 seconds shall start. If the level is above the established setpoint after the timer times out then the lag3 variable speed pump shall start. All variable speed pumps shall be controlled by the wetwell level to operate at the same speed and maintain the level in the wetwell. If wetwell level drops below the setpoint level for lag3 pump operation by the amount established in step A, an adjustable timer initially set for 60 seconds shall start. If the timer times out and the level is below the established level then the lag3 variable speed pump shall shut down and the system shall operate as described in step C.

E. If the wetwell level rises above the setpoint level for the lag3 pump operation by the amount established in step B, an adjustable timer initially set at 60 seconds shall start. If the level is above the established setpoint after the timer times out then the lag4 variable speed pump shall start. All variable speed pumps shall be controlled by the wetwell level to operate at the same speed and maintain the level in the wetwell. If wetwell level drops below the setpoint level for lag4 pump operation by the amount established in step A, an adjustable timer initially set for 60 seconds shall start. If the timer times out and the level is below the established level then the lag4 variable speed pump shall shut down and the system shall operate as described in step D.

The wetwell and pump selection shall be alternated per the following requirements:

- a. Control shall alternate wet wells on each lead pump start and select pump with the lowest hours of operation for each new start.
- b. Control options shall provide the ability to isolate each wet well for service, while maintaining pump station operation.
- c. Control options shall allow the operator to set the total number of pumps that can be active.
- d. Upon the activation of a high level alarm from a float ball, the station shall automatically switch to the backup float control panel and take over operation of the station from the RTU panel. The SCADA system shall indicate a PLC failure alarm under this condition.

Initially, the pump lead selection shall be at the HMI.

Wetwell Level Selection

Wetwell level sensor selection shall be provided via the HMI. The selected sensor shall be utilized by the control strategies for the station.

The RTU/PLC Panel shall provide local automatic monitoring of float switches, transducers, and dry contacts. Inputs shall be provided for both digital inputs and analog (4 to 20 milliamps DC) transducers. If a critical analog level sensing device fails, then an alternate level sensing device(s) shall be automatically activated. Analog sensors and specific float alarms shall report to the central HMIs if floats operate out of sequence. The RTU shall be supplied with an input for an emergency "high level float". UPS backup power shall be provided so that monitoring is maintained during utility power failures.

Alarms and other functionality to be provided

- A. The capability to remotely override or disable individual pumps shall be provided. These functions shall be logged with a time stamp at the redundant central HMIs.
- B. The capability to remotely disable the pump station shall be provided. This function shall be logged with a time stamp at the redundant central HMIs.
- C. The RTU shall report elapsed runtime and number of starts for each pump to the central HMIs. These values shall be stored in the RTU. In the case of failure of the RTU, these values shall be restored without user intervention. The central HMIs shall have the ability to individually reset each pump's starts and/or runtimes without loss of data.
- D. An alarm shall be provided to indicate that all 5 AFDs are in Auto. Refer to the electrical schematic for fail signal devices.
- E. The RTU shall be provided with routines to detect individual pump fault alarms and shall report these alarms to the central HMIs:
 - a. A pump is called to run, but fails to start;
 - b. When a pump is called to turn off, but continues to run; or
 - c. When a pump is running and shuts off before it is called to turn off.
- F. The Station Power Fail shall be generated by the Automatic Transfer Switch:
 - a. Upon loss of phase;

- b. Phase reversal;
- c. Low or high line voltages;
- d. Low or high Phase voltages from Phase A to Phase B, from Phase C to Phase B and from Phase A to Phase C on three-phase systems;

Status Indications

See the I/O list,

PLC Powerup

On PLC powerup, control of the pump shall be set to remote auto mode if the pump was previously operating in automatic. Pumps shall start in 1 minute intervals to avoid all the pumps starting at once.

Power Failure

Control of the pump shall resume with the control mode established prior to the power failure. Pumps will start in 1 minute intervals to avoid all the pumps starting at once. If operating on generator power, the number of pumps allowed to operate shall be one less than the normal number of pumps installed in the pump station.

HMI Requirements

None

Calculations

None

Data Mapping

None

End of Section

This page was left blank intentionally

PANEL MOUNTED INSTRUMENTS

PART 1 - GENERAL.

1-1. SCOPE. The Panel Mounted Instrument section covers the furnishing of all panel mounted instruments and accessories required for the Instrumentation and Control System as indicated on the drawings.

Equipment and services provided under this section shall be subject to the Instrumentation and Control System section. This section shall be used and referenced only in conjunction with the Instrumentation and Control System section. Supplementing the Instrumentation and Control System section, instrument data, special requirements, and options are indicated on the drawings or the Instrument Device Schedule.

When multiple instruments of a particular type are specified, and each requires different features, the required features are described on the drawings or the Instrument Device Schedule.

1-2. DESIGN CRITERIA. The instruments shall be installed to measure, monitor, or display the specified process at the ranges and service conditions indicated on the drawings or as indicated in the Instrument Device Schedule. The instruments shall be installed at the locations indicated on the drawings or the Instrument Device Schedule.

Where possible, each instrument shall be factory calibrated to the calibration ranges indicated on the drawings or in the Instrument Device Schedule. Transmitters or similar measurement instruments shall be calibrated using National Institute of Standards and Technology (NIST) approved bench calibration procedures, when such procedures exist for the instrument type. For "smart" devices, calibration data shall be stored digitally in each device, including the instrument tag designation indicated on the drawings and/or Instrument Device Schedule.

1-3. SUBMITTALS. Submittals shall be as specified in the Instrumentation and Control System section.

PART 2 - PRODUCTS

2-1. GENERAL. The following paragraphs describe minimum device stipulations. The drawings or Instrument Device Schedule shall be used to determine any additional instrument options, requirements, or service conditions.

2-1.01 Programming Device. For systems that require a dedicated programming device for calibration, maintenance, or troubleshooting, one such programming device shall be provided for each Owner facility (quantity required shall be as indicated in the Instrumentation and Control System section). The programming device shall include appropriate operation manuals and shall be included in the training stipulations. For systems that allow the programming device functions to be implemented in software, running on a laptop computer, the software shall be provided instead of the programming device.

2-1.02 Configuration Software/Serial Interface. Devices indicated as requiring a serial interface shall be provided with all accessories to properly communicate over the serial link. An appropriate cable shall be provided to allow the transmitter serial interface to be connected to a personal computer. One licensed copy of the diagnostic/interface software shall be provided for each Owner facility (quantity required shall be as indicated in the Instrumentation- General Requirements section). Software shall be capable of running under the Windows XP operating system. If the software furnished performs the same functions as the programming device, specified elsewhere, then the programming device shall not be furnished.

2-2. PANEL FRONT MOUNTED DEVICES.

2-2.01. Annunciators. Not used.

2-2.02. Totalizers. Not used.

2-2.03. Digital Panel Indicators. Digital indicators shall be designed for semi-flush mounting in a panel. The indicator shall be a 3-1/2 digit LED, LCD, or gas discharge type display, with digits at least 0.5 inch [12.7 mm] high. The indicator shall be easily read at a distance of 10 feet [3 m] in varying control room lighting environments. Operating temperature range shall be 32°F [0°C] to 140°F [60°C]. Accuracy shall be ± 0.1 percent. The indicator shall be scaled in engineering units, with the units engraved on the display face or on the associated nameplate. The indicator shall have a selectable decimal point and shall provide over-range indication. Digital indicators shall be manufactured by Action Instruments, Crompton Instruments, Newport Electronics, Precision-Digital, or Red Lion.

2-2.04. Electronic Bar Graph Indicators. Not used.

2-2.05. Edgewise Panel Indicators. Not used.

2-2.06. Manual Loading Stations. Not used.

2-2.07. Ratio Stations. Not used.

2-2.08. Electronic Indicating Control Stations. Not used.

2-2.09. 1/4 DIN Single-Loop Control Stations. Not used.

2-2.10. 1/4 DIN Manual/Auto Backup Stations. Not used.

2-2.11. Large Case Recorders. Not used.

2-2.12. Strip Chart Recorders. Not used.

2-2.13. Pressure Gauges. Not used.

2-2.14. Digital and Panel Clocks. Not used.

2-2.15. Switches, Lights, and Push Buttons.

2-2.15.01. Selector Switches. Selector switches shall be heavy-duty, oil-tight type with gloved-hand or wing lever operators. Position legends shall be engraved on the switch faceplate. Switches for electric circuits shall have silver butting or sliding contacts, rated 10 amperes continuous at 120 V ac. Contact configuration shall be as indicated on the drawings or for the application. Switches used in electronic signal circuits shall have contacts suitable for that duty. Switches shall be Cutler-Hammer "Type 10250T", Square D "Class 9001 Type SKS" or approved equal.

2-2.15.02. Indicating Lights. Not used.

2-2.15.03. Push Buttons. Push buttons shall be heavy-duty, oil-tight type. Legends shall be engraved on the push-button faceplate. Contacts shall be rated 10 amperes continuous at 120 V ac. Push buttons shall be Cutler-Hammer "Type 10250T, Square D "Class 9001 Type SKR" or approved equal.

2-3. PANEL INTERIOR MOUNTED DEVICES.

2-3.01. Integrators. Not used.

2-3.02. Power Supplies. Not used.

2-3.03. Relays. Control panel relays shall be Potter Brumfield Type KRPA or approved equal. Control panel time delay relays shall be Eagle Signal 22 Series or approved equal. RTU relays shall be Allen Bradley Type 700-HK or approved equal.

2-3.04. Intrinsically Safe Relays. Not used.

2-3.05. Electronic Signal Booster/Isolators. Not used.

2-3.06. Electronic Signal Selectors. Not used.

2-3.07. Electronic Signal Summers. Not used.

2-3.08. Fixed Deadband Signal Monitors. Not used.

2-3.09. Adjustable Deadband Signal Monitors. Not used.

2-3.10. Strip Heaters. Not used.

2-3.11. Intrinsically Safe Barriers. Not used.

PART 3 – EXECUTION

3-1 FIELD SERVICES. Manufacturer's field services shall be provided for installation, field calibration, startup, and training as specified in the Instrumentation and Control System section. Instruments shall not be shipped to the Work Site until two weeks prior to the scheduled installation. SYSTEM SUPPLIER shall be responsible for coordinating the installation schedule with the Installation Contractor. Each shipment shall contain a listing of protective measures required to maintain sensor operation, including a listing of any common construction or cleaning chemicals that may affect instrument operation.

End of Section

Section 13562
FLOW INSTRUMENTS

PART 1 - GENERAL

1-1. SCOPE. The Flow Instrument Section covers the furnishing of flow instruments and accessories required for the Instrumentation and Control System as indicated on the drawings.

Equipment and services provided under this section shall be subject to the Instrumentation and Control System section. This section shall be used and referenced only in conjunction with the Instrumentation and Control System section. Supplementing the Instrumentation and Control System section, instrument data, special requirements, and options are indicated on the drawings or the Instrument Device Schedule.

When multiple instruments of a particular type are specified, and each requires different features, the required features are described on the drawings or the Instrument Device Schedule.

1-2. DESIGN CRITERIA. Each device shall be a pre-assembled, packaged unit. Upon delivery to the work site, each device or system shall be ready for installation with only minor piping and electrical connections required by Contractor.

Primary elements shall derive any required power from the transmitter, unless otherwise indicated.

The instruments shall be installed to measure, monitor, or display the specified process at the ranges and service conditions indicated on the drawings or as indicated in the Instrument Device Schedule. The instruments shall be installed at the locations indicated on the drawings or in the Instrument Device Schedule.

Where possible, each instrument shall be factory calibrated to the calibration ranges indicated on the drawings or in the Instrument Device Schedule. Transmitters or similar measurement instruments shall be calibrated using National Institute of Standards and Testing (NIST) approved bench calibration procedures, when such procedures exist for the instrument type. Calibration data shall be stored digitally in each device, including the instrument tag designation indicated on the drawings or Instrument Device Schedule.

1-3. SUBMITTALS. Submittals shall be made as specified in the Instrumentation and Control System section .

1-4. SHIPMENT, PROTECTION, AND STORAGE. Equipment provided under this section shall be shipped, protected, and stored as specified in the Instrumentation and Control System section. Identification of packaging shall be as specified in the Instrumentation and Control System section.

PART 2 - PRODUCTS

2-1. GENERAL. The following paragraphs provide minimum device requirements. The drawings or Instrument Device Schedule shall be used to determine any additional instrument options, requirements, or service conditions.

2-1.01. Interconnecting Cable. For instruments where the primary element and transmitter are physically separated, interconnecting cable from the element to the transmitter shall be provided. The cable shall be the type approved by the instrument manufacturer for the intended purpose of interfacing the element to the transmitter. Length of cable shall be a minimum of three meters or as indicated on the drawings or in the Instrument Device Schedule.

2-1.02. Programming Device. For instruments that require a dedicated programming device for calibration, maintenance, or troubleshooting, one such programming device shall be provided for each Owner facility (quantity required shall be as indicated in the Instrumentation and Control System section). The programming device shall include appropriate operation manuals and shall be included in the training requirements. For systems that allow the programming device functions to be implemented in software, running on a laptop computer, the software shall be provided instead of the programming device.

2-1.03. Configuration Software/Serial Interface. Devices indicated as requiring a serial interface shall be provided with all accessories required to properly communicate over the serial link. As a minimum, an appropriate cable shall be provided to allow the transmitter serial interface to be connected to a personal computer. One licensed copy of the diagnostic/interface software shall be provided for each Owner facility (quantity required shall be as indicated in the Instrumentation-General Requirements Section). Software shall be capable of running under the Windows XP operating system. If the software furnished performs the same functions as the programming device, specified elsewhere, then the programming device shall not be furnished.

2-2. FLOW INSTRUMENTATION.

2-2.01. Differential Pressure Flow Transmitters. Not used.

2-2.02. Magnetic Flowmeters, Signal Converters, and Accessories.

1. The magnetic flow meter shall be of the low frequency electromagnetic induction type and shall produce a DC pulsed signal directly proportional and linear to the liquid flow rate. The meter shall be designed for operation on 120-VAC plus/minus 10 percent, 60 hertz, plus/minus 5 percent with a power consumption of less than 20 watts for sizes through 12 inches.

2. The metering tubes shall be constructed of stainless steel. All magnetic flow meters shall be designed to mount directly in the pipe between ANSI Class 150 flanges and shall consist of a flanged pipe spool piece with laying length of at least 1-1/2 times the meter diameter. Meters shall have polyurethane liners with stainless steel electrodes.

3. The electronics portion of the magnetic flow meter shall include both a magnet driver to power the magnet coils and a signal converter. The signal converter shall be integrally mounted. The converter shall include a separate customer connection section to isolate the electronics compartment and protect the electronics from the environment. A separate

terminal strip for power connection shall be supplied. The electronics shall be of the solid state, feedback type and utilize integrated circuitry. The input span of the signal converter shall be continuously adjustable between 0-1 and 0-31 fps for both analog and frequency outputs. The converter shall not be affected by quadrature noise nor shall it require zero adjustment or special tools for start-up.

4. Input and output signals shall be fully isolated. The converter output shall be 4 to 20 ma DC into 0 to 900 ohms.

5. Meter shall be suitable for outdoors installation and shall be furnished complete with grounding rings and installation hardware including studs, nuts, gaskets, and flange adapter hardware.

6. The converter shall include an integral zero return to provide a constant zero output signal in response to an external dry contact closure.

7. Converter shall also include digital type switches for direct adjustment of scaling factor in engineering units along with integral calibration self-test feature to verify proper operation of the electronics.

8. The meter shall be hydraulically calibrated at a facility located in the United States and the calibration shall be traceable to the *National Bureau of Standards*. A computer printout of the actual calibration data giving indicated versus actual flows at a minimum of three flow rates shall be provided with the meter. A certification letter shall accompany the computer printout of the calibration data for each meter referencing the meter's serial number. The accuracy of the metering system shall be 1 percent of rate from 10 to 100 percent of flow for maximum flow velocities of 3 to 31 feet per second.

9. Complete zero stability shall be an inherent characteristic of the meter system to eliminate the need to zero adjust the system with a full pipe at zero flow.

10. The meter housing shall be splash-proof and weather resistant design. The meter shall be capable of accidental submergence in up to 30 feet of water for up to 48 hours without damage to the electronics or interruption of the flow measurement.

The flowmeter shall be the Unimag model manufactured by EMCO and no other. The flowmeter transmitter shall be model 4411e manufactured by EMCO and no other.

2-2.03. Open Channel Ultrasonic Flow meters. Not used.

2-2.04. Open Channel Admittance Probe Flowmeters. Not used.

2-2.05. Doppler Ultrasonic Flowmeters. Not used.

2-2.06. In-Line Type Ultrasonic Flowmeters (Single Path). Not used.

2-2.07. In-Line Type Ultrasonic Flowmeters (Multi-Path). Not used.

2-2.08. Averaging Pitot Type Flow Elements. Not used.

2-2.09. Thermal Dispersion Flowmeters. Not used.

2-2.10. Propeller Flowmeters. Not used.

- 2-2.11. Turbine Flowmeters. Not used.
- 2-2.12. Orifice Plates. Not used.
- 2-2.13. Differential Pressure Flow Indicators. Not used.
- 2-2.14. Gas Service Rotameters. Not used.
- 2-2.15. Liquid Service Rotameters. Not used.
- 2-2.16. Target-Type Flow Switches. Not used.

PART 3 - EXECUTION

3-1. FIELD SERVICES. Manufacturer's field services shall be provided for installation, field calibration, startup, and training as specified in the Instrumentation and Control System section.

Instruments shall not be shipped to the Work Site until two weeks prior to the scheduled installation. The System Supplier shall be responsible for coordinating the installation schedule with the Installation Contractor. Each shipment shall contain a listing of protective measures required to maintain sensor operation, including a listing of any common construction or cleaning chemicals that may affect instrument operation.

End of Section

PRESSURE AND LEVEL INSTRUMENTS

PART 1 - GENERAL

1-1. SCOPE. The Pressure and Level Instruments section covers the furnishing of pressure and level instruments and accessories required for the Instrumentation and Control System as indicated on the drawings.

Equipment and services provided under this section shall be subject to the Instrumentation and Control System section. This section shall be used and referenced only in conjunction with the Instrumentation and Control System section. Supplementing the Instrumentation and Control System section, instrument data, special requirements, and options are indicated on the drawings or the Instrument Device Schedule.

When multiple instruments of a particular type are specified, and each requires different features, the required features are described on the drawings or the Instrument Device Schedule.

1-2. DESIGN CRITERIA. Each device shall be a pre-assembled, packaged unit. Upon delivery to the work site, each device or system shall be ready for installation with only minor piping and electrical connections required by Contractor.

Primary elements shall derive any required power from the transmitter, unless otherwise indicated.

The instruments shall be installed to measure, monitor, or display the specified process at the ranges and service conditions indicated on the drawings or as indicated in the Instrument Device Schedule. The instruments shall be installed at the locations indicated on the drawings or in the Instrument Device Schedule.

Where possible, each instrument shall be factory calibrated to the calibration ranges indicated in the drawings or in the Instrument Device Schedule. Transmitters or similar measurement instruments shall be calibrated using National Institute of Standards and Technology (NIST) approved bench calibration procedures, when such procedures exist for the instrument type. Calibration data shall be stored digitally in each device, including the instrument tag designation indicated on the drawings and/or Instrument Device Schedule.

1-3. SUBMITTALS. Submittals shall be made as specified in the Instrumentation and Control System section.

1-4. SHIPMENT, PROTECTION, AND STORAGE. Equipment provided under this section shall be shipped, protected, and stored in accordance with the requirements of the Instrumentation and Control System section. Identification of packaging shall be as described in the Instrumentation and Control System section.

PART 2 - PRODUCTS

2-1. GENERAL. The following paragraphs provide minimum device stipulations. The drawings or Instrument Device Schedule shall be used to determine any additional instrument options, requirements, or service conditions.

2-1.01. Interconnecting Cable. For systems where the primary element and transmitter are physically separated, interconnecting cable from the element to the transmitter shall be provided. The cable shall be the type approved by the instrument manufacturer for the intended purpose of interfacing the element to the transmitter. Length of cable shall be a minimum of three meters or as indicated in the drawings or Instrument Device Schedule.

2-1.02. Programming Device. For systems that require a dedicated programming device for calibration, maintenance, or troubleshooting, one such programming device shall be provided for each Owner facility (quantity required shall be as indicated in the Instrumentation and Control System section.) The programming device shall include appropriate operation manuals and shall be included in the training requirements. For systems that allow the programming device functions to be implemented in software, running on a laptop computer, the software shall be provided instead of the programming device.

2-1.03. Configuration Software/Serial Interface. Devices indicated as requiring a serial interface shall be provided with all accessories required to properly communicate over the serial link. An appropriate cable shall be provided to allow the transmitter serial interface to be connected to a personal computer. One licensed copy of the diagnostic/interface software shall be provided for each Owner facility (quantity required shall be as indicated in the Instrumentation and Control System section). Software shall be capable of running under Microsoft's Windows XP operating system. If the software furnished performs the same functions as the programming device, specified elsewhere, then the programming device shall not be furnished.

2-2. PRESSURE AND LEVEL INSTRUMENTATION.

2-2.01. Pressure and Pressure Sensing Level Transmitters. Transmitters shall be an all solid state electronic two-wire device that does not require a direct power connection to the transmitter. Process fluid shall be isolated from the sensing elements by AISI Type 316 stainless steel, Hastelloy-C, ceramic, or cobalt-chromium-nickel alloy diaphragms, and the transducer may use a silicone oil fluid fill. Transmitters shall have self-diagnostics and electronically adjustable span, zero, and damping. Transmitters shall be enclosed in a NEMA Type 4X housing and shall be suitable for operation at temperatures from 0° to 180°F [-17° to +82°C], and relative humidity of 5 to 100 percent. All parts shall be cadmium-plated carbon steel, stainless steel, or other corrosion-resistant materials. Transmitters shall have over-range protection to maximum line pressure. Accuracy of the transmitter shall be 0.075 percent of span, and transmitter output shall be 4-20 mA dc without the need for external load adjustment. Transmitters shall not be damaged by reverse polarity. Transmitters shall have an elevated or suppressed zero. For calibrated spans of less than 8 psig [55 kPa gage] a differential pressure type transmitter with side vents shall be utilized. Transmitters shall be provided with brackets for wall and pipe-stand mounting.

Transmitters shall be factory calibrated to the required range and provided with the manufacturer's standard hand-held communications/calibration device. One device shall be furnished for all transmitters provided by a single manufacturer.

Transmitters tagged on the drawings or specified to be indicating type shall be furnished with LCD type digital indicators.

Transmitters will have a turndown ration of 30:1, or more.

Where indicated on the drawings or in the Instrument Device Schedule, a diaphragm seal shall be provided. Diaphragm seals shall be thread-attached type with removable AISI Type 316 stainless steel diaphragm, zinc or cadmium plated carbon steel upper housing, and stainless steel lower housing. The upper housing shall be contoured to fit and provide a seat and seal for the diaphragm and shall be designed to permit removal of the gauge with the system under pressure. The lower housing shall be provided with a tapped and plugged 1/4 inch [6 mm] NPT flushing connection. Each diaphragm seal and the gauge served shall be factory assembled, filled with a suitable fluid, and calibrated as a unit.

Transmitters shall be Foxboro "Model IGP10-D", Endress & Hauser "Cerabar S", or "Deltabar S Series", ABB Model 264GS, or Rosemount Model 1151.

2-2.02. Premium Accuracy Pressure and Pressure Sensing Level Transmitters. Not used.

2-2.03. Differential Pressure Transmitters. Not used.

2-2.04. Premium Accuracy Differential Pressure Transmitters. Not used.

2-2.05. Flange-Mounted Pressure Sensing Level Transmitters. Not used.

2-2.06. Ultrasonic Level Transmitters. Not used.

2-2.07. Admittance Probe Level Transmitters. Not used.

2-2.08. Bubbler System Components. Not used.

2-2.09. Fixed-Mount Float Type Level Switches. Not used.

2-2.10. Weighted Float Type Level Switches. Each level switch shall consist of a single-pole, double-throw mercury switch, rated not less than 3 amp [A] ac, sealed and housed in a chemical-resistant polypropylene casing. The switch assembly shall be weighted and suspended on a waterproof, three-conductor, synthetic covered flexible cable with 19 AWG [0.5 mm²] conductors and of such length that no splice or junction box is required in the wet well. Switches shall be suitable for operation at up to 150 V ac within an ambient temperature range of 0 to 60°C. Switches shall be suitable for use in a sanitary wastewater wet well. Adjustable mounting hardware shall be provided for supporting each level switch. Mechanical floats will not be acceptable. Switches shall be B/W Controls "Series 7010", U.S. Filter Control Systems "Model LSC", Flygt "Type ENM-10", or Warrick Controls "Series M".

2-2.11. Adjustable Deadband Float Type Level Switch. Not used.

2-2.12. Electrode/Conductance Relay Level Switch. Not used.

2-2.13. Flange-Mounted Displacement Float Type Level Switches. Not used.

2-2.14. Pressure Switches. Not used.

2-2.15. Flood Level Switches. Not used.

2-2.16. Submersible Pressure Sensing Level Transmitters. Not used.

2-2.17. Ultrasonic Level Switches. Not used.

2-2.18. Pressure Gauges. Pressure gauges shall be of the indicating dial type, with C-type phosphor bronze Bourdon tube; stainless steel rotary geared movement; phenolic or polypropylene open front turret case; adjustable pointer; stainless steel, phenolic, or polypropylene ring; and acrylic plastic or shatterproof glass window.

Gauge dial shall be 4-1/2 inch [114 mm] size, with white background and black markings. The units of measurement shall be indicated on the dial face. Subdivisions of the scale shall conform to the requirements of the governing standard. Pointer travel shall be not less than 200 degrees or more than 270 degrees of arc.

Panel-mounted and surface-mounted gauges shall be provided with 1/4 inch [6 mm] NPT connections. All stem-mounted gauges shall be provided with 1/2 inch [12 mm] NPT connections. Where indicated in the drawings or on the Instrument Device Schedule, stem mounted gauges shall have an adjustable viewing angle to allow the gauge to be positioned for optimum viewing.

All pressure gauges shall measure in psi [kPa] and all vacuum gauges in inches [mm] water. All gauges shall have a suitable range to give mid-scale readings under normal conditions. Gauge accuracy shall be 0.5 percent of scale range.

Each gauge shall be provided with a threaded end, ball-type gauge valve. Gauge valve materials shall be compatible with the measured process. Where the process is not defined, gauge valves shall have AISI Type 316 stainless steel wetted parts and Teflon seals. Multi-port gauge valves shall have all unused ports plugged. Gauge valve construction shall be as detailed in Section 13565.

Where indicated on the drawings or in the Instrument Device Schedule, a diaphragm seal shall be provided for the respective gauge. Diaphragm seals shall be thread-attached type with removable AISI Type 316 stainless steel diaphragm, zinc or cadmium plated carbon steel upper housing, and stainless steel lower housing. The upper housing shall be contoured to fit and provide a seat and seal for the diaphragm and shall be designed to permit removal of the gauge with the system under pressure. The lower housing shall be provided with a tapped and plugged 1/4 inch [6 mm] NPT flushing connection. Each diaphragm seal and the gauge served shall be factory assembled, filled with a suitable fluid, and calibrated as a unit.

Gauges shall be installed at the locations indicated on the drawings, with installation conforming to the installation details. All gauges, snubbers, and diaphragm seals shall be installed in the vertical, upright position. Thread sealer, suitable for use with the associated process, shall be used in the assembly of threaded connections. All connections shall be free from leaks. Lines

shall be purged of trapped air at gauge locations prior to installation of the gauge or diaphragm seal.

Each gauge shall be provided with all required mounting hardware to securely mount the unit according to the mounting requirements indicated in the drawings or the Instrument Device Schedule.

Unless otherwise indicated, mounting and installation hardware shall be Type 316L stainless steel.

Pressure gauges shall be Ashcroft "1279 Duragauge", or equal.

2-2.19. Radar Level Transmitters. Radar level transmitter shall be a microprocessor-based electronic unit consisting of a antenna assembly, a signal converter/transmitter, and an interconnecting cable. The antenna shall be encapsulated in polypropylene. The unit shall be capable of operating with process temperature: -40 °C to +93 °C (-40 °F to +200 °F) Pressure: Vacuum to 13,8 bar (200 psi) Dielectric: 1,7 – 100. The radar level transmitter shall be a 2-wire, intrinsically safe, loop powered instrument. The radar level transmitter shall be by Magnetrol and shall be the R82-5B0A-011 model.

PART 3 - EXECUTION

3-1. FIELD SERVICES. Manufacturer's field services shall be provided for installation, field calibration, startup, and training as specified in the Instrumentation and Control System section.

Instruments shall not be shipped to the Work Site until two weeks prior to the scheduled installation. System Supplier shall be responsible for coordinating the installation schedule with the Installation Contractor. Each shipment shall contain a listing of protective measures required to maintain sensor operation, including a listing of any common construction or cleaning chemicals that may affect instrument operation.

End of Section

THIS PAGE LEFT BLANK INTENTIONALLY

MISCELLANEOUS INSTRUMENTS

PART 1 - GENERAL

1-1. SCOPE. The Miscellaneous Instruments section covers the furnishing of all miscellaneous instruments and accessories required for the Instrumentation and Control System as indicated on the drawings.

Equipment and services provided under this section shall be subject to the Instrumentation and Control System section. This section shall be used and referenced only in conjunction with the Instrumentation and Control System section. Supplementing the Instrumentation and Control System section, instrument data, special requirements, and options are indicated on the drawings or the Instrument Device Schedule.

When multiple miscellaneous instruments of a particular type are indicated, and each requires different selectable features, the required features are described on the drawings or in Instrument Device Schedule.

1-2. DESIGN CRITERIA. Each device shall be a pre-assembled, packaged unit. Upon delivery to the work site, each device or system shall be ready for installation with only minor piping and electrical connections required by System Supplier.

Primary elements shall derive any required power from the transmitter, unless otherwise indicated.

The instruments shall be installed to measure, monitor, or display the specified process at the ranges and service conditions indicated on the drawings or as indicated in the Instrument Device Schedule. The instruments shall be installed at the locations indicated on the drawings or the Instrument Device Schedule.

Where possible, each instrument shall be factory calibrated to the calibration ranges indicated in the Instrument Device Schedule. Transmitters or similar measurement instruments shall be calibrated using National Institute of Standards and Technology (NIST) approved bench calibration procedures, when such procedures exist for the instrument type. Calibration data shall be stored digitally in each device, including the instrument tag designation indicated on the Instrument Device Schedule.

1-3 SUBMITTALS. Submittals shall be made as specified in Instrumentation and Control System section.

1-4 SHIPMENT, PROTECTION, AND STORAGE. Equipment provided under this section shall be shipped, protected, and stored as specified in the Instrumentation and Control System section. Identification of packaging shall be as described in the Instrumentation and Control System section.

PART 2 - PRODUCTS

2-1. GENERAL. The following paragraphs provide minimum device stipulations. The Instrument Device Schedule shall be used to determine any additional instrument options, requirements, or service conditions.

2-1.01. Interconnecting Cable. For systems where the primary element and transmitter are physically separated, interconnecting cable from the element to the transmitter shall be provided. The cable shall be the type approved by the instrument manufacturer for the intended purpose of interfacing the element to the transmitter. Length of cable shall be a minimum of three meters or as indicated in the Instrument Device Schedule.

2-1.02. Programming Device. For instruments that require a dedicated programming device for calibration, maintenance, or troubleshooting, one such programming device shall be provided for each Owner facility (quantity required shall be as indicated in the Instrumentation and Control System section). The programming device shall include appropriate operation manuals and shall be included in the training requirements. For systems that allow the programming device functions to be implemented in software, running on a laptop computer, the software shall be provided instead of the programming device.

2-1.03. Configuration Software/Serial Interface. Devices indicated as requiring a serial interface shall be provided with all accessories required to properly communicate over the serial link. An appropriate cable shall be provided to allow the transmitter serial interface to be connected to a personal computer. One licensed copy of the diagnostic/interface software shall be provided for each Owner facility (quantity required shall be as indicated in the Section 13560 general data sheet). Software shall be capable of running under Microsoft's Windows XP operating system. If the software furnished performs the same functions as the programming device, specified elsewhere, then the programming device shall not be furnished.

2-2. MISCELLANEOUS INSTRUMENTS.

2-2.01. Resistance Temperature Detectors. Not used.

2-2.02. Resistance Temperature Transmitters. Not used.

2-2.03. Temperature Switches. Not used.

2-2.04. Temperature Gauges. Not used.

2-2.05. Field-Mounted Process Indicators. Not used.

2-2.06. Milliamp Calibrator. Not used.

2-2.07. Pressure Calibrator. Not used.

2-2.08. Multi-function Instrument Calibrator. Not used.

2-2.09. Manometer. Not used.

2-2.10. Proximity (Door) Switches. Proximity switches shall be magnetic proximity type, consisting of two sensors. One sensor shall be fixed to the door and the other to the door frame. The sensor mounted to the door shall have no electrical connections. Switches shall be provided with DPDT contacts rated 5 amperes at 120 V ac. All necessary mounting hardware shall be provided to allow both the sensors to be installed at the locations indicated on the drawings.

2-2.11. Vibration Switches. Not used.

2-2.12. Instrument Shutoff Valves. Instrument shutoff valves shall be provided for instruments as indicated on the drawings and as detailed in the specifications. The indicated shutoff valves shall be provided by System Supplier for all instruments furnished under the Instrumentation – General Requirements section, the Panel Mounted Instruments section, the Flow Instruments section, the Pressure and Level Instruments section, the Analytical Instruments section, and the Miscellaneous Instruments section.. Shutoff valves shall be compatible with the measured process and shall be selected in accordance with the manufacturer’s recommendations for the specified process. Unused ports of multi-port gauge valves shall be plugged. An instrument shutoff valve schedule shall be submitted indicating the quantity, material, size, and associated instrument. Permanent tagging of the instrument valves is not required. However, temporary hand-written tags or other means of identification shall be provided to ensure that the appropriate valve is installed for a given instrument.

Instrument shutoff valves shall be D/A Manufacturing, Anderson-Greenwood, or equal.

2-2.13. Limit Switches. Not used.

2-2.14. Modulating Valve Positioners. Not used.

2-2.15. Current-to-Pressure Transducers. Not used.

2-2.16. Valve Position Transmitters. Not used.

PART 3 - EXECUTION

3-1. FIELD SERVICES. Manufacturer's field services shall be provided for installation, field calibration, startup, and training as specified in the Instrumentation and Control System section.

Instruments shall not be shipped to the Work Site until two weeks prior to the scheduled installation. The System Supplier shall be responsible for coordinating the installation schedule with the Installation Contractor. Each shipment shall contain a listing of protective measures required to maintain sensor operation, including a listing of any common construction or cleaning chemicals that may affect instrument operation.

End of Section

This page was left blank intentionally

PANELS, CONSOLES, AND APPURTENANCES

PART 1 - GENERAL

1-1. SCOPE. The Panels, Consoles and Appurtenances section covers the furnishing of panels, consoles, and appurtenances as indicated on the drawings.

1-1.01. Control System. The Instrumentation and Control System section shall apply to all equipment furnished under the Panels, Consoles and Appurtenances section.

1-2. GENERAL. Equipment furnished and installed under this section shall be fabricated and assembled in full conformity with the drawings, specifications, engineering data, instructions, and recommendations of the equipment manufacturer, unless exceptions are noted by Engineer.

1-2.01. General Equipment Stipulations. The General Equipment Stipulations shall apply to all equipment and materials provided under this section. If requirements in this specification differ from those in the General Equipment Stipulations, the requirements specified herein shall take precedence.

1-2.02. Drawings. General dimensions and arrangements are indicated on the drawings. System Supplier shall be responsible for coordinating the console and enclosure sizes and arrangements to accommodate the equipment provided.

1-3. SUBMITTALS. Submittals shall be made as specified in the Instrumentation and Control System section.

1-4. DELIVERY, STORAGE, AND SHIPPING. Delivery, storage and shipping shall be as per The Instrumentation and Control System section.

PART 2 - PRODUCTS

2-1. PANEL DESIGN AND FABRICATION FEATURES. All panels furnished shall conform to the stipulations of NEMA ICS-6-1993. Unless indicated otherwise on the drawings, the following paragraphs describe general fabrication specifications for the PLC cabinets, instrument panels, consoles, enclosures, and subpanels.

2-1.01. Piping. Pneumatic tubing shall be 1/4 inch [6 mm] OD, soft annealed copper with compression fittings. Tubing and fittings shall be as specified in the Miscellaneous Piping section.

2-1.01.01. Fittings. Compression type bulkhead fittings shall be provided near the bottom or the top of the panel for all field connections. Compression nuts and sleeves shall be provided for the field connections. Indicators, recorders, controllers, and other pneumatic devices shall be provided with plugged test connections and shutoff valves for isolation.

2-1.01.02. Valves. All devices shall have separate air supply shutoff valves. Valves and compression fittings shall be as manufactured by Nupro, Parker Hannifin, Swagelock, Tylok, or Whitey.

2-1.02. Instrument Wiring. All internal instrument and component device wiring shall be as normally furnished by the manufacturer. Annunciator and indicating light circuits shall be minimum 16 AWG. Electronic analog circuits shall be 16 AWG twisted and shielded pairs rated not less than 300 volts. Analog circuits shall be separated from ac power circuits.

All wiring to the control devices within the RTU panel shall be harnessed and permanently attached to the panel using welded 8-32 studs and stud mounted cable ties. Stick-on tie wrap fasteners are not acceptable. Wiring shall be supported a minimum of every eight inches. The panel shall be grounded via 10-32 stud located in the bottom hinged side and bonded to the enclosure and ground buss.. Each individual wire in power, control, and instrumentation circuits shall be provided with identification markers at each point of termination. The wire markers shall be positioned to be readily visible for inspection and the identification numbers shall match the identification on the supplier's panel wiring drawings. Sufficient space shall be provided between cable groups and terminal blocks for easy installation or removal of cables.

2-1.03. Power Entrance. The power entrance to each panel shall be provided with a surge protection device. Surge protectors shall be Surge Suppression Inc model SSLA1S1, PSI model 120HWCP-15, or Innovative Technologies XT40-1p101.

2-1.04. Power Wiring. Power distribution wiring on the line side of panel fuses shall be minimum 12 AWG. Secondary power distribution wiring and wiring for control circuits shall be minimum 14 AWG. Wiring for ac power distribution, dc power distribution, and control circuits shall have different colors and shall agree with the color-coding legend on System Supplier's panel wiring diagrams. With the exception of electronic circuits, all interconnecting wiring and wiring to terminals for external connection shall be stranded copper, insulated for not less than 600 volts, with a moisture resistant and flame retardant covering rated for not less than 90°C.

2-1.05. Terminal Blocks. Terminal blocks for external connections shall be suitable for 12 AWG wire and shall be rated 30 amperes at not less than 300 volts. Terminal blocks shall be fabricated complete with marking strip, covers, and pressure connectors. Terminals shall be labeled to agree with identification shown on the supplier's submittal drawings. A terminal shall be provided for each conductor of external circuits, plus one ground for each shielded cable. Not less than 8 inches of clearance shall be provided between the terminal strips and the base of vertical panels for conduit and wiring space. Not less than 25 percent spare terminals shall be provided. Each control loop or system shall be individually fused, and all fuses or circuit breakers shall be clearly labeled and located for easy maintenance.

2-1.06. Device Tag Numbering System. All devices shall be provided with permanent identification tags. The tag numbers shall agree with the Instrument Device Schedule and with the supplier's equipment drawings. All field-mounted transmitters and devices shall have stamped stainless steel identification tags. Panel, subpanel, and rack-mounted devices shall have laminated phenolic identification tags securely fastened to the device. Hand-lettered labels or tape labels will not be permitted.

2-1.07. Nameplates. Nameplates shall be provided on the face of the panel or on the individual device. Panel nameplates shall have approximate dimensions and legends, as indicated on the drawings, and shall be made of laminated phenolic material having engraved letters approximately 3/16 inch [5 mm] high extending through the black face into the white layer. Nameplates shall be secured firmly to the panel. Panel face nameplates do not replace the requirement for device identification tags as specified under the Device Tag Numbering System paragraph.

2-1.08. Painting. The enclosure, sub-panel and dead front operator panel shall be painted with heat fused polyester powder, electro-statically applied paint on a phosphatized base. The enclosure shall be white, inside and outside. The interior panels shall be silver-tek bronze.

2-1.09. Factory Test. Panels shall be factory tested electrically and pneumatically by the panel fabricator before shipment.

2-2. FREESTANDING VERTICAL PANELS. Not used.

2-3. FILTER CONSOLES. Not used.

2-4. WALL-MOUNTED CABINETS. Cabinets, which contain the system components indicated on the drawings, shall be NEMA Type 12, 3R, 4, or 4X enclosures, suitable for wall mounting. The enclosures shall be fabricated from USS 14 gage [1.9 mm thick], or heavier, carbon steel, stainless steel, or fiberglass. Cabinets shall be equipped with full size gasket equipped doors with hinges and a chromium-plated or stainless steel three-point latch. A screened vent shall be provided in the bottom of enclosures that contain pneumatic devices. All wall-mounted cabinets shall meet the requirements of the panel fabrication paragraph of this section. Outdoor cabinets shall be provided with sunshades as indicated on the drawings.

2-4.01. Additional Panel Requirements. Additional requirements shall be as required below:

A. All assemblies shall be UL listed and approved.

B. RTU Mountings - indoors (Dry location within non-corrosive environment)

a. The RTU shall be mounted in a NEMA 12, steel enclosure with a lockable, three point latching mechanism.

C. A 14-gauge painted steel back panel shall be provided to mount all electrical control devices. All interior electrical control components mounted on the back panel shall be secured using a minimum size of 8-32 stainless steel machine screws. Heavier items, including the RTU panel, control power transformers and items in excess of 10 pounds, shall be secured with 1/4-20 stainless steel machine screws. Screw anchor nuts shall be permanently installed in the sub-panel using cadmium plated steel knurled threaded inserts AKV Model AKS7 or equal. No self-tapping or sub-panel tapped screws shall be used.

D. There shall be a permanently affixed document pocket in the interior side of the exterior enclosure door to include a laminated wiring diagram and bill of materials.

E. No devices or equipment shall be mounted to the top of the control panel enclosure, exclusive of radio antenna.

F. Environmental Ratings:

All components shall be able to operate at –22 degrees Fahrenheit or lower to 140 degrees Fahrenheit and higher at 95 percent humidity.

G. See panel schedule.

2-5. WALL MOUNTED INSTRUMENT SUBPANELS. Not used.

2-6. CONTROL SYSTEM CONSOLES AND ENCLOSURES. Not used.

2-7. CONTROL SYSTEM FURNITURE. Not used.

PART 3 - EXECUTION

3-1. GENERAL INSTALLATION REQUIREMENTS. Installation requirements are specified in the Instrumentation and Control System section. In addition, equipment furnished under this section shall conform to the following manufacturing stipulations.

3-1.01. Piping. All tubing shall be run in horizontal and vertical planes and shall be rigidly supported to withstand handling and shipment. Flexible polyethylene tubing shall be used to connect devices mounted on hinged doors.

3-1.02. Wiring. All wiring shall be grouped or cabled and firmly supported inside the panel. Wiring shall be bundled in groups and routed in Panduit or similar nonmetallic slotted ducts. Ducts shall be readily accessible within the panel with removable covers and shall have a space of at least 40 percent of the depth of the duct available for future use after installation is complete and all field wiring installed. Sufficient space shall be provided between cable groups or ducts and terminal blocks for easy installation or removal of cables.

3-1.03. More Than One Panel. Where signal or loop wiring must be routed to more than one panel or device, the required circuit routing shall be as indicated on the one-line diagrams. The panel fabricator shall provide such additional circuits as may be indicated on the electrical schematic drawings.

End of Section

Equipment Schedule 13570-S02

Wall Mounted Cabinet Schedule

1.000	General					
1.010	Specification Section 13570P, Revision 1.2, 9/2/99					
2.000	Wall Mounted Cabinets (PR 2-4)	RTU/PCP	BPCP			
2.010	Tag Number/Panel ID	PS3151-1	PS3151-2			
2.020	NEMA type enclosure					
	12	X	X			
	3R					
	4					
	4X					
2.030	Materials					
	Carbon steel					
	Stainless steel	X	X			
	Fiberglass polyester					
2.040	Required environmental controls					
	Sun shade					
	Cooling fan					
	Air conditioned					
3.000	Exceptions, Clarifications, and Comments					
3.010	None	X	X			
	UL-508	X	X			

THIS PAGE LEFT BLANK INTENTIONALLY

REMOVAL OF ABOVEGROUND FUEL STORAGE TANKS

PART 1 – GENERAL

1-1. SCOPE This section covers the draining, removal, and completion of closure assessment activities for existing aboveground fuel storage, associated fuel tank accessories, including the removal of existing fuel dispensers at PS 3151 (Dr. Phillips). The above ground diesel fuel tank at PS 3151 has the capacity of 1,000 gallons. Contractor shall provide necessary labor, materials, and supervision required to remove and dispose of the stored product, equipment pad, and all related above ground piping.

All such work must be accomplished in accordance with all federal, state, county, and local requirements as well as accepted safety standards. Before initiating work, the appropriate government agencies shall be consulted concerning applicable regulatory requirements and to obtain any permits required.

1-2 GENERAL

1-2.01. Coordination Equipment removed under this section shall be inspected, disassembled, removed, relocated, and placed in proper storage conditions in full conformity with drawings, specifications, engineering data, instructions, and recommendations furnished by the equipment manufacturer unless exceptions are noted by the Engineer.

All equipment for this section shall comply with federal state, county, and local regulations concerning above ground storage tanks. In the event that state or local regulations exceed the requirements of this specification, the regulations shall take precedence.

All work shall be performed in accordance with the 1996 Edition of NFPA-30, Chapter 62-762 FAC, and Chapter 62-761 FAC.

The removal of the equipment shall be coordinated with the installation of the new fuel storage tanks, the Contractor shall coordinate the removal from service and storage of the existing fuel storage tanks with the Owner to minimize impact on operations schedules.

1-3. SUBMITTALS Prior to starting the work the Contractor shall submit the following;

- a. Name of all Subcontractors.
- b. Location and method of disposal for all waste materials for recording purposes only.
- c. A site specific health and safety plan and contingency plan.
- d. Schedule and sequence of each tank removal.

1-4. STORAGE AND HANDLING Equipment shall be stored and handled in accordance with the General Equipment Stipulations and the equipment manufacturer's recommendations.

PART 2 – PRODUCTS

2-1. PREPARATION AND PERFORMANCE OF TANK REMOVAL The Contractor shall be responsible for performing the tasks as identified in the FDEP Storage Tank System Closure Assessment Requirements, Chapter 62-762.801 F.A.C. and Chapter 62-761.800 F.A.C., which shall include, but shall not be limited to the following.

- a. Perform storage tank closure assessment which includes existing soils and groundwater evaluation, as stated in the FDEP Storage Tank System Closure Assessment Requirements.
- b. Contact all State and Local regulatory agencies to obtain work permits and to file the required notice of work commencement, if required.
- c. The contractor shall inspect each tank prior to removal activities to the extent required to be able to safely perform the work.
- d. All electrical power connected to the tank or ancillary equipment shall be disconnected at the circuit breaker.
- e. Prior to tank cleaning, remove all stored fuel from each tank and collect in drums or tank truck and dispose thereof. Drain and flush all piping back into the tank and remove all residual fuel, sludge, and water.
 - If any piping is abandoned in place all contents of the piping shall be removed by flushing or other approved means. Fluids generated during the pipe flushing operation must be captured for proper disposal and not allowed to spill onto the ground or into the tank excavation. The ends of the piping must be capped and sealed.
 - All fuel residues, fluids, sludge, and cleaning materials removed from the tank shall be disposed of at an approved disposal site as recognized by the State. Materials shall be manifested, as required by State and Federal regulations.
- f. Disconnect and cap, or remove and dispose of the storage tank and associated piping. Manways shall be secured to prevent access. Remove and dispose of the concrete equipment pad and any attachments.
 - Prior to disposing of the piping, the latest applicable waste disposal regulations shall be checked to determine if special attention of preparation is required.
- g. During removal of the tank and piping, the Contractor will be responsible for any spills. This includes containment, providing proper notification of the incident in accordance with Chapter 62-770, notifying the emergency contact for Orange County Government Risk Management Environmental Loss Prevention Coordinator (Tisha Pence: 407-836-9638), all cleanup of the incident including disposal of the contaminated soil and replenishing with clean soil.

- h. Close the storage tank systems in accordance with paragraphs 62-762.801(3)(b) F.A.C, as applicable; and conduct a closure assessment in accordance with subsection 62-762.801(4) F.A.C.
- i. The above ground tanks shall be rendered free of pollutant vapors at the time of closure to prevent hazardous explosive conditions, and maintained to prevent future explosive conditions.
- j. The above ground tanks shall also be protected from flotation in accordance with NFPA 30, Section 2-6.

PART 3 – EXECUTION.

3.1. **REMOVAL** Each fuel storage tank and all accessories shall be carefully removed and disposed of by the Contractor in accordance with all requirements.

End of Section

THIS PAGE LEFT BLANK INTENTIONALLY

Section 15010

VALVE INSTALLATION

PART 1 - GENERAL

1-1. SCOPE. This section covers the installation of new valves and actuators purchased by Contractor as part of this Work.

Pressure and leakage testing and pipe supports are covered in other sections.

The following specification sections are applicable to valves to be installed:

<u>Section</u>	<u>Title</u>
15091	Miscellaneous Ball Valves
15093	Check Valves
15094	Backflow Preventers
15102	Eccentric Plug Valves
15108	Air Release/Combination Air Valves

1-2. GENERAL. Equipment installed under this section shall be erected and placed in proper operating condition in full conformity with drawings, specifications, engineering data, instructions, and recommendations of the equipment manufacturer, unless exceptions are noted by Engineer.

1-2.01. Coordination. When manufacturer's field services or installation check services are provided by the valve manufacturer, Contractor shall coordinate the services with the valve manufacturer. Contractor shall give Engineer written notice at least 30 days prior to the need for manufacturer's field services.

Flanged connections to valves including the bolts, nuts, and gaskets are covered in the appropriate pipe specification section.

1-3. DELIVERY, STORAGE, AND HANDLING.

1-3.01. Storage. Upon delivery, all equipment and materials shall immediately be stored and protected by Contractor in accordance with Handling and Storage section and the manufacturer's instructions until installed in the Work. Stored equipment shall be protected by Contractor against damage and exposure from the elements. At no time shall the equipment be stored on earth or grass surfaces or come into contact with earth or grass. Contractor shall keep the equipment dry at all times.

PART 2 - PRODUCTS

Not Applicable.

PART 3 - EXECUTION

3-1. INSPECTION. All valves and accessories shall be inspected for damage and cleanliness before being installed. Any material damaged or contaminated in handling on the job shall not be used unless it is repaired and re-cleaned to the original requirements by Contractor. Such material shall be segregated from the clean material and shall be inspected and approved by Owner or his representative before its use.

3-2. INSTALLATION.

3-2.01. General. Valves shall be installed with sufficient clearance for proper operation of any external mechanisms, and with sufficient clearance to dismantle the valve for in-place maintenance. Installation shall be in accordance with the valve manufacturer's recommendations.

Unless otherwise indicated on the drawings, all valves installed in horizontal runs of pipe having centerline elevations 4 feet 6 inches or less above the finish floor shall be installed with their operating stems vertical. Valves installed in horizontal runs of piping having centerline elevations between 4 feet 6 inches and 6 feet 9 inches above the finish floor shall be installed with their operating stems horizontal. If adjacent piping prohibits this, the stems and operating hand wheel shall be installed above the valve horizontal centerline as close to horizontal as possible. Valves installed in vertical runs of pipe shall have their operating stems oriented to facilitate the most practicable operation, as reviewed by Engineer.

3-2.02. Installation Checks. When specified in the valve sections, the valve manufacturer will provide installation checks. For installation checks, the manufacturer's field representative will inspect the valve installation immediately following installation by Contractor. The manufacturer's representatives will revisit the site as often as necessary to ensure installation satisfactory to Owner.

Contractor shall perform no Work related to the installation or operation of materials or equipment furnished by others without direct observation and guidance of the field representative, unless Engineer and manufacturer furnishing such materials concur otherwise.

3-2.03. AWWA Butterfly Valves. Not used.

3-2.04. Check Valves.

3-2.04.01. Swing Check Valves. Install valves oriented for the correct flow direction. Only valves designed for vertical installation shall be installed in vertical piping.

3-2.05. Eccentric Plug Valves. Eccentric plug valves shall be installed with the shaft horizontal and the plug in the upper half of the valve body. Valves in wastewater, sludge, or scum lines shall be installed with the seat on the upstream end.

3-2.06. Resilient Seated Gate Valves. Not used.

3-2.07. Double Disc Gate Valves. Not used.

3-2.08. Air Release and Combination Air Valves. The exhaust from each valve shall be piped to a suitable point acceptable to Engineer. Air release valve exhaust piping leading to a trapped floor drain shall terminate at least 6 inches above the floor.

3-2.09. Valve Boxes. Valve boxes shall be set plumb. Each valve box shall be placed directly over the valve it serves, with the top of the box brought flush with the finished grade. After each valve box is placed in proper position, earth fill shall be placed and thoroughly tamped around the box.

3-2.10. Yard Hydrants. Not used.

3-2.11. Fire Hydrants. Not used.

3-3. VALVE ACTUATORS. Valve actuators and accessories shall be installed in accordance with the equipment manufacturer's recommendations.

3-4. FIELD QUALITY CONTROL.

3.4.01. Field Testing. After installation, all valves shall be tested in conjunction with the Pipeline Pressure and Leakage Testing section.

3-4.01.01. Pressure Tests. Pressure testing shall be in accordance with the Pipeline Pressure and Leakage Testing section.

3-4.01.02. Leakage Tests. All valves shall be free from leaks. Each leak that is discovered within the correction period stipulated in the General Conditions shall be repaired by and at the expense of Contractor. This requirement applies whether pressure testing is required or not.

3-5. ADJUSTING. After installation, the opening and closing time shall be adjusted as needed for each pneumatic, hydraulic and electric actuated valve.

End of Section

This page was left blank intentionally

MISCELLANEOUS PIPING AND ACCESSORIES INSTALLATION

PART 1 - GENERAL

1-1. SCOPE. This section covers the installation of piping and accessories as indicated on the drawings for the following piping sections:

<u>Section</u>	<u>Description</u>
15060	Miscellaneous Piping and Pipe Accessories
15064	Stainless Steel Pipe, Tubing, and Accessories
15065	Miscellaneous Steel Pipe, Tubing, and Accessories
15067	Miscellaneous Plastic Pipe, Tubing, and Accessories

Contractor shall furnish all necessary jointing materials, coatings, and accessories that are specified herein.

Pipe supports and anchors shall be furnished by Contractor, and are covered in the Pipe Supports section. Pipe trenching and backfilling are covered in the Trenching and Backfilling section.

1-2. GENERAL.

1-2.01. Coordination. Materials installed under this section shall be installed in full conformity with drawings, specifications, engineering data, instructions, and recommendations of the manufacturer, unless exceptions are noted by Engineer.

1-3. SUBMITTALS.

1-3.01. Drawings and Data. Complete specifications, data, and catalog cuts or drawings shall be submitted in accordance with the Submittals section. Items requiring submittals shall include, but not be limited to, the following:

Watertight/dusttight pipe sleeves.

Materials as specified herein.

1-3.02. Welder Certification. Prior to the start of the work, Contractor shall submit a list of the welders he proposes using and the type of welding for which each has been qualified. Copy of certification and identification stamp shall be submitted for each welder. Qualification tests may be waived if evidence of prior qualification is deemed suitable by Engineer.

1-3.03. Spool Drawings. Not Used.

1-4. QUALITY ASSURANCE.

1-4.01. Welding and Brazing Qualifications. All welding and brazing procedures and operators shall be qualified by an independent testing laboratory in accordance with the applicable provisions of Section IX of the ASME Code. All procedure and operator qualifications shall be in written form and subject to Engineer's review. Accurate records of operator and procedure qualifications shall be maintained by Contractor and made available to Engineer upon request.

1-4.02. Tolerances. These tolerances apply to in-line items and connections for other lines.

The general dimension, such as face-to-face, face or end-to-end, face- or end-to center, and center-to-center shall be 1/8 inch [3 mm].

The inclination of flange face from true in any direction shall not exceed 3/64 inch per foot [4 mm per meter].

Rotation of flange bolt holes shall not exceed 1/16 inch [1.5 mm].

1-5. DELIVERY, STORAGE, AND HANDLING. Shipping shall be in accordance with the Shipping section. Handling and storage shall be in accordance with the Handling and Storage section. All materials shall be stored in a sheltered location above the ground, separated by type, and shall be supported to prevent sagging or bending.

Plastic pipe, tubing, and fittings shall be stored between 40°F and 90°F [4°C and 32°C].

1-5.01. Coated Pipe. Handling methods and equipment used shall prevent damage to the protective coating and shall include the use of end hooks, padded calipers, and nylon or similar fabric slings with spreader bars. Bare cables, chains, or metal bars shall not be used. Coated pipe shall be stored off the ground on wide, padded skids. Plastic-coated pipe shall be covered or otherwise protected from exposure to sunlight.

PART 2 - PRODUCTS

2-1. SERVICE CONDITIONS. Pipe, tubing, and fittings covered herein shall be installed in the services indicated in the various pipe sections.

2-2. MATERIALS.

Threaded Fittings

Anti-Seize Thread Lubricant	Jet-Lube "Nikal", John Crane "Thred Gard Nickel", Never-Seez "Pure Nickel Special", or Permatex "Nickel Anti-Seize".
-----------------------------	--

Teflon Thread Sealer	Paste type; Hercules "Real-tuff", John Crane "JC-30", or Permatex "Thread Sealant with Teflon".
----------------------	---

Teflon Thread Tape	Hercules "Tape Dope" or John Crane "Thread-Tape".
Solvent Welded Fittings	
Solvent cement for PVC Systems	ASTM D2564.
Solvent cement for CPVC Systems	ASTM F493.
Sodium Hypochlorite, Sodium Hydroxide, and Sodium Bisulfite Service	IPS Corporation "Weld-On 724"
Primer for PVC Systems	ASTM F656.
Solder or Brazed Fittings	
Solder	Solid wire, ASTM B32, ANSI/NSF 61 certified, Alloy Grade Sb5, (95-5).
Soldering Flux	Paste type, ASTM B813.
Brazing Filler Metal	AWS A5.8, BCuP-5; Engelhard "Silvaloy 15", Goldsmith "GB-15", or Handy & Harman "Sil-Fos".
Brazing Flux	Paste type, Fed Spec O-F-499, Type B.
Insulating Fittings	
Threaded	Dielectric steel pipe nipple, ASTM A53, Schedule 40, polypropylene lined, zinc plated; Perfection Corp. "Clearflow Fittings".
Flanged	EpcO "Dielectric Flange Unions" or Central Plastics "Insulating Flange Unions".
Pipe Insulation	See Mechanical Insulation section.
Watertight/Dusttight Pipe Sleeves	O-Z Electrical Manufacturing "Thruwall" and "Floor Seals", or Thunderline "Link-Seals"; with modular rubber sealing elements, nonmetallic pressure plates, and 316 stainless steel bolts and nuts.
Pipe Sleeve Sealant	Polysulfide or urethane, as specified in the Caulking section or as indicated on the drawings.
Protective Coatings	

Tape Wrap	ANSI/AWWA C209, except single ply tape thickness shall not be less than 30 mils [760 µm]; Protecto Wrap "200" or Tapecoat "CT".
Primer	As recommended by the tape manufacturer.
Coal Tar Epoxy	High-build coal tar epoxy; Ameron "Amercoat 78HB Coal Tar Epoxy", Carboline "Bitumastic 300 M", Tnemec "46H-413 Hi-Build Tneme-Tar", or Sherwin-Williams "Hi-Mil Sher-Tar Epoxy".

PART 3 - EXECUTION

3-1. INSPECTION. All piping components shall be inspected for damage and cleanliness before being installed. Any material damaged or contaminated in handling on the job shall not be used unless it is repaired and recleaned to the original requirements by Contractor. Such material shall be segregated from the clean material and shall be inspected and approved by Owner or his representative before its use.

3-2. PREPARATION.

3-2.01. Field Measurement. Pipe shall be cut to measurements taken at the site, not from the drawings. All necessary provisions shall be made in laying out piping to allow for expansion and contraction. Piping shall not obstruct openings or passageways. Pipes shall be held free of contact with building construction to avoid transmission of noise resulting from expansion.

3-3. INSTALLATION.

3-3.01. General. All instruments and specialty items shall be installed according to the manufacturer's instructions and with sufficient clearance and access for ease of operation and maintenance.

Flat faced wrenches and vises shall be used for copper tubing systems. Pipe wrenches and vises with toothed jaws will damage copper materials and shall not be used. Bends in soft temper tubing shall be shaped with bending tools.

3-3.02. Pipe Sleeves. Piping passing through concrete or masonry shall be installed through sleeves that have been installed before the concrete is placed or when masonry is laid. Unless otherwise indicated on the drawings, in all other locations where pipes pass through floors, pipe sleeves shall project not less than 1 inch [25 mm] nor more than 2 inches [50 mm] above the floor surface, with the projections uniform within each area. In the case of insulated pipes, the insulation shall extend through pipe sleeves. Where the drawings indicate future installation of pipe, sleeves fitted with suitable plastic caps or plugs shall be provided.

Unless otherwise indicated on the drawings, all pipes passing through walls or slabs which have one side in contact with earth or exposed to the weather shall be sealed watertight with special rubber-gasketed sleeve and joint assemblies, or with sleeves and modular rubber sealing elements.

Piping shall be made dusttight and gastight with sleeves sealed with modular rubber sealing elements, when passing through pump station wetwell walls.

3-3.03. Pipe Joints. Pipe joints shall be carefully and neatly made in accordance with the indicated requirements.

3-3.03.01. Threaded. Pipe threads shall conform to ANSI/ASME B1.20.1, NPT, and shall be fully and cleanly cut with sharp dies. Not more than three threads at each pipe connection shall remain exposed after installation. Ends of pipe shall be reamed after threading and before assembly to remove all burrs. Unless otherwise indicated, threaded joints shall be made up with teflon thread tape, thread sealer, or a suitable joint compound.

Threaded joints in plastic piping shall be made up with teflon thread tape applied to all male threads. Threaded joints in stainless steel piping shall be made up with teflon thread sealer and teflon thread tape applied to all male threads. Threaded joints in steel piping for chlorine service shall be made up with teflon thread tape or litharge and glycerine paste applied to all male threads.

3-3.03.02. Compression. Ends of tubing shall be cut square and all burrs shall be removed. The tubing end shall be fully inserted into the compression fitting and the nut shall be tightened not less than 1-1/4 turns and not more than 1-1/2 turns past fingertight, or as recommended by the fitting manufacturer, to produce a leaktight, torque-free connection.

3-3.03.03. Flared. Ends of annealed copper tubing shall be cut square, and all burrs shall be removed prior to flaring. Ends shall be uniformly flared without scratches or grooves. Fittings shall be tightened as needed to produce leaktight connections.

3-3.03.04. Soldered and Brazed. Where solder fittings are specified for lines smaller than 2 inches [50 mm], joints may be soldered or brazed at the option of Contractor. Joints in 2 inch [50 mm] and larger copper tubing shall be brazed. Brazing alloy shall contain no tin. Joints in copper chlorine tubing and refrigerant piping shall be brazed; solder will not be acceptable.

Surfaces to be joined shall be thoroughly cleaned with flint paper and coated with a thin film of flux. At each joint, tubing shall enter to the full depth of the fitting socket.

Care shall be taken to avoid overheating the metal or flux. Each joint shall be uniformly heated to the extent that filler metal will melt on contact. While the joint is still hot, surplus filler metal and flux shall be removed with a rag or brush.

3-3.03.05. Solvent Welded. Solvent welded connections shall only be used for PVC or CPVC pipe. All joint preparation, cutting, and jointing procedures shall comply with the pipe manufacturer's recommendations and ASTM D2855. Pipe ends shall be beveled or chamfered to the dimensions recommended by the manufacturer. Newly assembled joints shall be suitably

blocked or restrained to prevent movement during the setting time recommended by the manufacturer. Pressure testing of solvent welded piping systems shall not be performed until the applicable curing time, as set forth in Table X2.1 of ASTM D2855, has elapsed. Solvent welding shall be performed by bonding operators who have met the requirements of ASME B31.3 and A328.

3-3.03.06. Epoxy and Adhesive Bonded. Not Used.

3-3.03.07. Heat Fusion Bonded. Not Used.

3-3.03.08. Flanged. Flange bolts shall be tightened sufficiently to slightly compress the gasket and effect a seal, but shall not be torqued less than the minimum value required by the gasket manufacturer. Flange bolts shall not be so tight as to fracture or distort the flanges. A plain washer shall be installed under the head and nut of bolts connecting plastic pipe flanges. Anti-seize thread lubricant shall be applied to the threaded portion of all stainless steel bolts during assembly.

Flange bolt holes shall be oriented as follows, unless otherwise indicated on the spool drawings:

Vertical flange face:	Bolt holes to straddle the vertical centerlines.
Horizontal flange face:	Bolt holes to straddle plant north-south centerlines.

Pipe sealants, thread compounds, or other coatings shall not be applied to flange gaskets unless recommended by the gasket manufacturer for the specified service and approved by Engineer.

Welds at orifice flanges shall have internal surfaces ground smooth to the pipe wall.

Slip-on flanges shall be welded inside and outside. There shall be a distance of approximately 1/16 to 1/8 inch [1.5 to 3 mm] between the edge of the fillet weld and the face of the flange. The seal weld shall be applied so that the flange face shall be free of weld spatter and does not require refacing.

Flat-faced flanges shall be used when mating to Class 125 flanges. Full-face gaskets shall be used with flat-faced flanges and ring gaskets shall be used with raised faced flanges.

Weld neck flanges shall be used with butt-weld fittings. The bore of weld neck flanges shall match the pipe wall thickness.

Insulating joints connecting submerged (buried) piping to exposed piping shall be installed above the maximum water surface elevation and before the first pipe support not having coated anchor bolts or adhesive-bonded concrete anchors. All submerged (buried) metallic piping shall be isolated from the concrete reinforcement. Insulating flanges shall be tested for electrical isolation after installation and bolt-up but prior to introduction of conducting fluid.

3-3.03.09. Welded. Welding shall conform to the specifications and recommendations contained in the "Code for Pressure Piping", ANSI B31.1.

Weld cross-sections shall be equal to or greater than the pipe wall thickness. Welds shall be smooth and continuous and shall have interior projections no greater than 1/16 inch [1.5 mm]. Backing strips or rings shall not be used except with specific prior review by Engineer as to use, material, and design. Root gap inserts that are completely melted and consumed in the weld bead are acceptable only when reviewed in advance by Engineer.

Stainless steel welding shall be inert gas tungsten arc (TIG) or the direct current, straight polarity, inert gas metal arc process (MIG).

Carbon steel welding shall be made by the shielded metal arc process.

3-3.03.10. Grooved Couplings. Not Used.

3-3.03.11. Push-on. Gasket installation and other jointing procedures shall be in accordance with the recommendations of the manufacturer. Each spigot end shall be suitably beveled to facilitate assembly. All joint surfaces shall be lubricated with a heavy vegetable soap solution immediately before the joint is completed. Lubricant shall be suitable for use in potable water, shall be stored in closed containers, and shall be kept clean.

3-3.03.12. Rubber-Gasketed. Not Used.

3-3.03.13. Other Pipe Joints. Not Used.

3-3.04. Pipe. Pipe shall be installed as specified, as indicated on the drawings, or, in the absence of detail piping arrangement, in a manner acceptable to Engineer.

Piping shall be installed without springing or forcing the pipe in a manner which would induce stresses in the pipe, valves, or connecting equipment.

Piping shall be supported in conformance with the Pipe Supports section.

Piping shall be connected to equipment by flanges or unions as specified in the various piping sections. Piping connecting to equipment shall be supported by a pipe support and not by the equipment.

Water, gas, and air supply piping shall be provided with a shutoff valve and union at each fixture or unit of equipment, whether or not indicated on the drawings, to permit isolation and disconnection of each item without disturbing the remainder of the system. Air supply piping shall be provided with sectionalizing valves and valved air inlet connections as needed for isolation of portions of the system for periodic testing. Gas supply lines to buildings shall be provided with a shutoff valve and union located above grade immediately outside the building. A capped drip leg shall be provided at the bottom of the vertical riser of gas supply piping adjacent to gas-fired appliances.

A union shall be provided within 2 feet [600 mm] of each threaded-end valve unless there are other connections which will permit easy removal of the valve. Unions shall also be provided in piping adjacent to devices or equipment which may require removal in the future and where required by the drawings or the specifications.

Taps for pressure gauge connections on the suction and discharge of pumping units shall be provided with a nipple and a ball type shutoff valve.

Drilling and tapping of pipe walls for installation of pressure gauges or switches will not be permitted.

In all piping, insulating fittings shall be provided to prevent contact of dissimilar metals, including but not limited to, contact of copper, brass, or bronze pipe, tubing, fittings, valves, or appurtenances, or stainless steel pipe, tubing, fittings, valves, or appurtenances with iron or steel pipe, fittings, valves, or appurtenances. Insulating fittings shall also be provided to prevent contact of copper, brass, or bronze pipe, tubing, fittings, valves or appurtenances with stainless steel pipe, tubing, fittings, valves, or appurtenances.

Branch connections in horizontal runs of steam, air, and gas piping shall be made from the top of the pipe.

Buried PVC piping shall be "snaked" in the trench and shall be kept as cool as possible during installation. PVC pipe shall be kept shaded and shall be covered with backfill immediately after installation.

Piping adjacent to flow sensors shall be installed in accordance with the requirements of the manufacturer of the flow sensor and commonly accepted design practices of the appropriate straight pipe runs both upstream and downstream.

Drains required for operation are shown on the drawings. However, vents at all high points and drains at all low points in the piping that are required for complete draining for pressure test may not be shown on these drawings. Contractor shall add such items as found to be necessary during detail piping design and/or piping installation.

Locating wire, for electronically locating pipe after it is buried, shall be attached along the length of and installed with the pipe. This is applicable to all sizes and types of pressure mains. The tracing wire is to be attached to the pipe with nylon wire ties, as shown on the Drawings. The wire itself shall be 10-gauge single strand solid core copper wire with non-metallc insulation. The insulation shall be color coded for the type of pipe being installed. Continuous continuity must be maintained in the wire along the entire length of the pipe run. Permanent splices must be made in the length of the wire using wire connectors approved for underground applications as listed in the uniform electric code handbook. The wire shall extend to the surface and be connected to a test station box at valve locations in the manor, as shown on the Drawings.

3-3.05 Valves. Isolation valves provided with equipment and instruments shall be located in a manner which will allow ease of access and removal of the items to be isolated. Prior to soldering or brazing valves, teflon and elastomer seats and seals shall be removed to prevent damage.

3-3.06. Directional Drilling. Polyethylene pipe shall be installed by horizontal directional drilling in accordance with Orange County Standard Specification Section 3115: Directional Drilling. In case of conflict between section 3115 and this specification, the more stringent requirement shall govern.

3-4. PIPING ASSEMBLY.

3-4.01. General. Contractor shall only use labor that has been qualified by training and experience to capably perform the specified activities required to accomplish the work in a satisfactory manner

If there is a conflict between the mechanical drawings and piping and instrumentation drawings (P&IDs), the P&ID shall take precedence. Any deviations from the Specifications or piping locations shown on the drawings require prior review and approval by Engineer.

3-4.02. Buttwelded Piping. Not Used.

3-5. PROTECTIVE COATING. Standard weight steel pipe in buried locations will have exterior surfaces protected with a shop applied plastic coating.

Where specified in the Miscellaneous Steel Pipe, Tubing, and Accessories section, extra strong steel pipe in buried locations will have exterior surfaces protected with a shop applied plastic coating or a shop applied tape wrap. Where not specified to be shop coated or wrapped in the Miscellaneous Steel Pipe, Tubing and Accessories section, a tape wrap shall be field applied. The exterior surfaces of all fittings, couplings, specials, and other portions of buried piping not protected with plastic coating shall be tape-wrapped in the field.

All surfaces to be tape-wrapped shall be thoroughly cleaned and primed in accordance with the tape manufacturer's recommendations immediately before wrapping. The tape shall be applied by two-ply (half-lap) wrapping or as needed to provide a total installed tape thickness of at least 60 mils [1.5 mm]. Joints in plastic-coated pipe shall be cleaned, primed, and tape-wrapped after installation.

Joints in galvanized steel piping in underground locations shall be field painted with two coats of coal tar epoxy coating.

3-5.01. Inspection. All shop-applied plastic coatings and tape wrap on pipe or fittings shall be inspected for holidays and other defects after receipt of the pipe or fitting on the job and immediately before installation. All field-applied tape wrap on pipe, joints, fittings, and valves shall be inspected for holidays and other defects following completion of wrapping. Inspection of plastic coatings after installation of the pipe or fitting in the trench shall be made where, in the opinion of Engineer, the coating may have been damaged during installation. Holidays and defects disclosed by inspection shall be repaired in accordance with the recommendations of the coating or tape wrap manufacturer, as applicable.

The inspection shall be made using an electrical holiday detector. The detector and inspection procedures shall conform to the requirements of Section 4.4 of ANSI/AWWA C209.

3-6. PRESSURE AND LEAKAGE TESTING. All specified tests shall be made by and at the expense of Contractor in the presence, and to the satisfaction of Engineer. Each piping system shall be tested for at least 1 hour with no loss of pressure. The Contractor shall coordinate this

section with the Pipeline Pressure and Leakage Testing section. Piping shall be tested at the indicated pressures:

<u>Service</u>	<u>Test Pressure</u>	<u>Test Medium</u>
Water supply	1-1/2 times working pressure but not less than 120 psi [828 kPa]	Water
Other piping	1-1/2 times working pressure but not less than 50 psi [345 kPa]	Suitable fluid

Compressed air or pressurized gas shall not be used for testing plastic piping unless specifically recommended by the pipe manufacturer.

Leakage may be determined by loss-of-pressure, soap solution, chemical indicator, or other positive and accurate method acceptable to Engineer. All fixtures, devices, or accessories which are to be connected to the lines and which would be damaged if subjected to the specified test pressure shall be disconnected and the ends of the branch lines plugged or capped as needed during the testing.

Unless otherwise required by the applicable codes, drainage and venting systems shall be water or air tested. For water testing, the drainage and venting system shall be filled with water to the level of the highest vent stack. For air testing, the system shall be charged with air to a minimum pressure of 5 psig [35 kPa]. Openings shall be plugged as necessary for either type of test. To be considered free of leaks, the system shall hold the water or air for 30 minutes without any drop in the water level or air pressure.

All necessary testing equipment and materials, including tools, appliances and devices, shall be furnished and all tests shall be made by and at the expense of Contractor and at the time directed by Engineer.

All joints in piping shall be tight and free of leaks. All joints which are found to leak, by observation or during any specified test, shall be repaired, and the tests repeated.

3-7. CLEANING. The interior of all pipe, valves, and fittings shall be smooth, clean, and free of blisters, loose mill scale, sand, dirt, and other foreign matter when installed. Before being placed in service, the interior of all lines shall be thoroughly cleaned, to the satisfaction of Engineer.

Metal anhydrous ammonia, chlorine and sulfur dioxide piping shall be cleaned as recommended by the gas chemical feed system supplier. All surfaces which may come into contact with gas chemical shall be thoroughly dry and free of oil or grease before being placed in service. The recommended cleaning procedures shall be submitted for review in accordance with the Submittals section.

Tin-lined copper tubing for distribution of distilled water shall be flushed and cleaned with distilled water in accordance with the tubing manufacturer's recommendations.

3-8. ACCEPTANCE. Owner reserves the right to have any section of the piping system which he suspects may be faulty cut out of the system by Contractor for inspection and testing. Should the joint prove to be sound, Owner will reimburse Contractor on a time-and-material basis as specified in the Contract. Should the joint prove to be faulty, the destructive test will continue joint by joint in all directions until sound joints are found. Costs for replacement of faulty work and/or materials shall be the responsibility of Contractor.

End of Section

This page was left blank intentionally

BASIC MECHANICAL BUILDING SYSTEMS MATERIALS AND METHODS

PART 1 - GENERAL

1-1. SCOPE. This section covers general mechanical building system requirements as referenced from other sections and furnishing and installation of:

Mechanical equipment identification
Protective coatings

for the plumbing; heating, ventilating, and air conditioning systems.

1-2. GENERAL. Materials furnished and installed under this section shall be fabricated, assembled, erected, and placed in proper operating condition in full conformity with the drawings, specifications, engineering data, instructions, and recommendations of the manufacturer unless exceptions are noted by the Engineer.

1-2.01. Coordination. Where two or more units of the same class of materials are required, they shall be the product of a single manufacturer; however, all the component parts of the system need not be the products of one manufacturer.

1-2.02. General Equipment Stipulations. The General Equipment Stipulations shall apply to all materials furnished under this section. If requirements in this specification differ from those in the General Equipment Stipulations, the requirements specified herein shall take precedence.

1-2.03. Governing Standards. Except as modified or supplemented herein, all work covered by this section shall be performed in accordance with all applicable local codes and ordinances, laws, and regulations which pertain to such work. In case of a conflict between these specifications and any state law or local ordinance, the latter shall govern.

1-2.04. Metal Thickness. Metal thickness and gages specified herein are minimum requirements. Gages refer to US Standard gage.

1-3. SUBMITTALS.

1-3.01. Drawings and Data. Complete information, detailed specifications, and data covering materials, parts, devices, and accessories forming a part of the materials furnished, shall be submitted in accordance with the Submittals section.

Number Plates

Product data on number plates.

A listing of equipment to receive number plates shall be submitted.

Protective Coatings

Name of manufacturer.

Coating type.

Color.
Chemical resistance data.
Temperature range data.
Surface preparation.
Application data.
Film thickness per coat.
Drying and curing time information.

Equipment Motors

Name of Manufacturer.
Type and Model.
Horsepower (kW) rating and service factor.
Temperature rise and insulation rating.
Full load rotative speed.
Type of bearings and method of lubrication.
Net weight.
Overall dimensions.
Efficiency at full, 3/4, and 1/2 loads.
Full load current and power factor.
Locked rotor current.

1-4. QUALITY ASSURANCE.

1-4.01. Welding Qualifications. All welding procedures and welding operators shall be qualified by an independent testing laboratory in accordance with the applicable provisions of AWS Standard Qualification Procedures. All procedure and operator qualifications shall be in written form and subject to Engineer's review. Accurate records of operator and procedure qualifications shall be maintained by Contractor and made available to Engineer upon request.

1-4.02. Manufacturer's Experience. Unless the equipment manufacturer is specifically named in this section, the manufacturer shall have furnished equipment of the type and size specified which has been in successful operation for not less than the past 5 years.

1-5. EXTRA MATERIALS. The following extra materials shall be furnished for the listed equipment:

Touchup protective coating material

Extra materials shall be packaged in accordance with the Shipping section, with labels indicating the contents of each package. Each label shall indicate manufacturer's name, equipment name, equipment designation, part nomenclature, part number, address of nearest distributor, and current list price. Extra materials shall be delivered to Owner as directed.

PART 2 - PRODUCTS

2-1. SERVICE CONDITIONS. All equipment shall be designed and selected to meet the specified conditions. Where equipment is provided with protective coatings, unit capacities shall be corrected to account for any efficiency losses from the selected protective coating.

2-2. PERFORMANCE AND DESIGN REQUIREMENTS.

2-2.01. Dimensional Restrictions. Layout dimensions will vary between manufacturers and the layout area indicated on the drawings is based on typical values of the first manufacturer listed. Contractor shall review the contract drawings, the manufacturer's layout drawings, and installation requirements and shall make any modifications required for proper installation subject to acceptance by Engineer.

2-2.02. Elevation. Equipment shall be designed to operate at the elevation as indicated on the drawings.

2-2.03. Drive Units. Drive units shall be designed for 24 hour continuous service.

2-2.03.01. V-Belt Drives. Each V-belt drive shall include a sliding base or other suitable tension adjustment. V-belt drives shall have a service factor of at least 1.5 at maximum speed based on the nameplate horsepower [kW] of the drive motor unless otherwise indicated in the specific equipment paragraph.

2-2.03.02. Electric Motors. Motor horsepowers scheduled on the drawings are minimum motor horsepowers. Larger motors shall be provided if required to meet the specified capacities for the equipment furnished. Motors furnished with equipment shall meet the following requirements.

- a. All motors shall meet the minimum efficiency standards required by the Energy Policy Act (EPACT) of 1992.
- b. Designed and applied in accordance with NEMA, ANSI, IEEE, AFBMA, and NEC for the duty service imposed by the driven equipment, such as frequent starting, intermittent overload, high inertia, mounting configuration, or service environment.
- c. Rated for continuous duty at 40°C ambient.
- d. Motors used in applications which exceed the usual service conditions as defined by NEMA, such as higher than 40°C ambient, altitude exceeding 3,300 feet [1005 m], explosive or corrosive environments, departure from rated voltage and frequency, poor ventilation, frequent starting, or adjustable frequency drive applications, shall be properly selected with respect to their service conditions and shall not exceed specified temperature rise limits in accordance with ANSI/NEMA MG 1 for insulation class, service factor, and motor enclosure type.
- e. To ensure long life, motors shall have nameplate horsepower [kW] equal or greater than the maximum load imposed by the driven equipment and shall carry a service factor rating as follows:

<u>Motor Size</u>	<u>Enclosure</u>	<u>Service Factor</u>
Fractional hp [kW]	Open	1.15
	Other Than Open	1.0

Integral hp [kW]	Open	1.15
	Other Than Open	1.0

- f. Designed for full voltage starting.
- g. Designed to operate from an electrical system that may have a maximum of 5 percent voltage distortion according to IEEE 519.
- h. Totally enclosed motors shall have a continuous moisture drain that also excludes insects.
- i. Bearings shall be either oil or grease lubricated.
- j. Motor nameplates shall indicate as a minimum the manufacturer name and model number, motor horsepower, voltage, phase, frequency, speed, full load current, locked rotor current, frame size, service factor, power factor, and efficiency.
- k. Dripproof motors, or totally enclosed motors at Contractor's option, shall be furnished on equipment in indoor, above-grade, clean, and dry locations.
- l. Totally enclosed motors shall be furnished on:
 - (1) Outdoor equipment.
 - (2) Equipment for installation below grade.
 - (3) Equipment operating in chemical feed and chemical handling locations.
 - (4) Equipment operating in wet or dust-laden locations.
- m. Explosionproof motors shall be furnished as specified by applicable codes or as specified in other sections.
- n. A manufacturer's standard motor may be supplied on packaged equipment and fans in which case a redesign of the unit would be required to furnish motors of other than the manufacturer's standard design. However, in all cases, the motor types indicated are preferred and shall be furnished if offered by the manufacturer as a standard option.

2-3. MANUFACTURE AND FABRICATION.

2-3.01. Welding. All welds shall be continuous (seal type) on submerged or partially submerged components.

2-3.02. Anchor Bolts and Expansion Anchors. Anchor bolts, expansion anchors, nuts, and washers shall be as indicated in the Anchorage in Concrete and Masonry section unless otherwise indicated on the drawings.

2-3.03. Edge Grinding. Sharp corners of cut or sheared edges which will be submerged in operation shall be dulled by at least one pass of a power grinder to improve paint adherence.

2-3.04. Surface Preparation. All iron and steel surfaces, except motors, shall be shop cleaned by sandblasting or equivalent, in strict conformance with the paint manufacturer's

recommendations. All mill scale, rust, and contaminants shall be removed before shop primer is applied.

2-4. MATERIALS.

2-4.01. Mechanical Identification. Mechanical equipment shall be identified with engraved or stamped equipment plates securely affixed to the equipment in an accessible and visible location. Equipment plates shall be in addition to the number plates specified in the following paragraph. Equipment plates shall indicate the manufacturer's name, address, product name, catalog number, serial number, capacity, operating and power characteristics, labels of tested compliances, and any other pertinent design data. Equipment plates listing the distributing agent only will not be acceptable.

2-4.01.01. Number Plates. All equipment, panels, and control equipment denoted on the drawings by a symbol and an identifying number shall be provided with an identifying number plate. The identifying text shall be identical to the symbols indicated herein or on the drawings and shall be located in a conspicuous place. Number plate symbols and numbers shall be capitalized block letters with a minimum height as indicated below.

<u>Item Identified</u>	<u>Letter Height, inches [mm]</u>
Major Equipment	3/4 [19]
Minor Equipment	1/2 [13]
Control Panels	3/16 [5]

Number plate height shall be twice the letter height. Number plate length shall be as needed, with suitable margins all around. Lettering shall be placed in one row where practicable; however, where necessary due to excessive length, lettering shall be placed on more than one row and centered.

Number plates shall be in the form of nameplates unless equipment is too small to accommodate the specified nameplate, then tags shall be used. Nameplates and tags shall be metal or plastic. Plastic nameplates and tags shall be laminated phenolic not less than 1/8 inch [3 mm] thick and shall be black with a white core. Metal nameplates and tags shall be at least 12 gage [2.66 mm] thickness with engraved or imprinted symbols. Tags shall have smooth edges and shall be a minimum diameter of 1-1/2 inches [38 mm]. Hand-lettered or tape labels will not be acceptable. Tags shall be installed with corrosion-resistant chains or straps. Nameplates shall be installed with corrosion-resistant mechanical fasteners.

Number plates for control equipment such as but not limited to thermostats, control stations, and emergency ventilation shutoff switches shall in addition to the specific device identification list the controlled equipment in parenthesis below the device number.

2-4.01.02. Piping. Piping identification shall be as specified in the Protective Coatings section. The lettering size, length of color field, colors, and viewing angles of identification devices shall be in accordance with ASME A13.1.

2-4.01.03. Valves. Valves that have been assigned an identification number shall be identified with tags. Valve tags shall comply with the requirements listed in the Number Plates paragraph.

2-4.01.04. Ductwork. Ductwork shall be identified with nameplates as specified herein, or stenciled painting as specified in the Protective Coatings section. Ductwork shall be identified with the equipment number and area served, direction of airflow, and service (supply, return, mixed, exhaust, and outside air). The identification shall be located at equipment, at each side of structure or enclosure penetrations, and at each obstruction.

2-4.02. Seismic Restraints. Not used.

2-4.03. Protective Coatings. Where indicated on the drawings, sheet metal ductwork, dampers, registers, grilles, and equipment shall be given a protective coating suitable for the corrosive atmosphere indicated. Sheet metal ductwork, dampers, registers, grilles, and equipment construction shall be suitable to allow proper application of the protective coating system in accordance with the manufacturer's recommendation.

PART 3 - EXECUTION

3-1. INSTALLATION. Materials furnished under this section shall be installed in proper operating condition in full conformity with the drawings, specifications, engineering data, instructions, and recommendations of the manufacturer, unless exceptions are noted by the Engineer.

The installation of identifying devices shall be coordinated with the application of covering materials and painting where devices are applied to surfaces. All surfaces to receive adhesive number plates shall be cleaned before installation of the identification device.

End of Section

Section 15060

MISCELLANEOUS PIPING AND PIPE ACCESSORIES

PART 1 - GENERAL

1-1. SCOPE. This section covers the furnishing of miscellaneous piping and pipe accessories. Miscellaneous piping shall be furnished complete with all fittings, flanges, unions, and other accessories specified herein.

1-2. SUBMITTALS.

1-2.01. Drawings and Data. Complete specifications, data and catalog cuts or drawings shall be submitted in accordance with the submittals section. Submittals are required for all piping, fittings, gaskets, sleeves, and accessories, and shall include the following data:

- Name of Manufacturer
- Type and model
- Construction materials, thickness, and finishes
- Pressure and temperature ratings

Contractor shall obtain and submit a written statement from the gasket material manufacturer certifying that the gasket materials are compatible with the joints specified herein and are recommended for the specified field test pressures and service conditions.

1-3. DELIVERY, STORAGE, AND HANDLING. Shipping shall be in accordance with the Shipping section. Handling and storage shall be in accordance with the Handling and Storage section. All materials shall be stored in a sheltered location above the ground, separated by type, and shall be supported to prevent sagging or bending.

PART 2 - PRODUCTS

2-1. MATERIALS. Miscellaneous piping materials shall be as specified herein.

2-1.01. Material Classification BR-1.

BR-1 – Regular Weight Brass Pipe Gauge piping for hot/cold water.	Pipe	ASTM B43, red brass, seamless, regular weight.
	Fittings	ANSI/ASME B16.15, Class 125.

2-1.02. Material Classification BR-2. Not used.

- 2-1.03. Material Classification HS-1. Not used.
- 2-1.04. Material Classification HS-2. Not used.
- 2-1.05. Material Classification TG-1. Not used.
- 2-1.06. Material Classification CRP-1. Not used.
- 2-1.07. Accessories. Accessories for the miscellaneous piping systems shall be as indicated.

Unions for brass pipe Fed Spec A-A-59617, Class 125.

PART 3 - EXECUTION

3-1. INSTALLATION. Materials furnished under this section will be installed in accordance with the Miscellaneous Piping and Accessories Installation section.

End of Section

DUCTILE IRON PIPE

PART 1 - GENERAL

1-1. SCOPE. This section covers the furnishing and installation of ductile iron pipe. Ductile iron pipe shall be furnished complete with all fittings, jointing materials, pipe hangers and supports, anchors, blocking, encasement, and appurtenances. Piping shall be furnished by Contractor.

Piping furnished hereunder shall be complete with all joint gaskets, bolts, and nuts required for installation of any valves and equipment furnished by others for installation under this contract.

Pipe hangers and supports, pressure and leakage testing, cleaning, disinfection, and cathodic protection are covered in other sections. Cast iron soil pipe is covered in the Miscellaneous Piping section. Pipe trenching, embedment, and backfill are covered in the Trenching and Backfilling section.

1-1.01. Main Pipe Supplier. All ductile iron pipe, fittings, and specials shall be fabricated, lined, coated, and furnished under the direction and management of one pipe supplier, (the Main Pipe Supplier). The Contractor shall designate the Main Pipe Supplier and notify them in writing of their responsibilities, which shall include, at a minimum; ensure and certify that all pipe, fittings, specials, and other materials specified herein, are being manufactured in full accordance with the contract documents; prepare and submit all submittal information and shop drawings; and make any corrections that may be required to submittal information and shop drawings.

1-1.02. Main Pipe Supplier's Experience and Field Services. The Main Pipe Supplier's minimum required experience qualifications shall include manufacture of a pipeline at least 1 mile [1.6 km] in length, of a diameter equal to or larger than the pipe to be provided, with joints, lining, and coating suitable for the same or a higher pressure rating, which has performed satisfactorily for the past 5 years.

All ductile iron pipe shall be installed in accordance with the Main Pipe Supplier recommendations.

1-2. SUBMITTALS. Drawings, details, specifications, and installation schedules covering all ductile iron pipe and accessories shall be submitted in accordance with the Submittals section. The drawings and data shall include, but shall not be limited to, the following:

Certification by manufacturer for each item furnished in accordance with the ANSI/AWWA Standards.

Restrained joints details.

Certification of pipe manufacturer's field services, including a copy of the initial

services, and all subsequent inspection reports.

Certification of gaskets, certifying that gasket material is suitable for services intended.

Certification of joint lubricant.

Certification of proof-of-design tests for joints, including restrained joints.

Certification of pipe manufacturer or fabricator and certification of proof-of-design tests for welded-on outlets.

Laying schedule complete with an explanation of all abbreviations used in the schedule. For long, straight pipe runs, the laying schedule shall list the pipeline station and centerline elevation at least every 100 feet.

Two samples of the polyethylene encasement, each sample clearly identified as required by the Governing Standards and test results from an independent third party laboratory of the requirements specified in ANSI/AWWA C105/A21.5.

The method that the Contractor proposes to use for measuring deflection of pipe joints.

Submittal data shall clearly indicate the country of origin of pipe, fittings, flanges, restraining devices, and accessories.

Contractor shall submit a written statement from the gasket material manufacturer certifying that the gasket materials are compatible with the joints specified herein and are recommended for the specified field test pressures and service conditions.

1-2.01. Emergency Repair Manual. Not used.

1-3. SHIPPING, HANDLING, AND STORAGE. Shipping shall be in accordance with the Shipping section. Handling and storage shall be in accordance with the Handling and Storage section, and as specified herein.

Pipe, fittings, and accessories shall be handled in a manner that will ensure installation in sound, undamaged condition. Equipment, tools, and methods used in handling and installing pipe and fittings shall not damage the pipe and fittings. Hooks inserted in ends of pipe shall have broad, well-padded contact surfaces. Unpadded hooks, wire brushes or other abrasive tools shall not be permitted to come into contact with polyethylene lining if such lining is specified.

Contractor-furnished pipe and fittings in which the lining has been damaged shall be replaced by and at the expense of Contractor. With the concurrence of Engineer, small and readily accessible damaged areas may be repaired.

If the lining of Owner-furnished pipe or fittings is damaged by Contractor during unloading or handling, the damaged pipe or fittings shall be replaced by and at the expense of Contractor. Where the damaged areas are small and readily accessible, Contractor may be permitted to repair the lining.

Contractor shall repair any damage to pipe coatings before the pipe is installed.

PART 2 – PRODUCTS. Each length of pipe shall bear the name or trademark of the manufacturer, the location of the manufacturing plant and the class or strength classification of the pipe. The markings shall be plainly visible on the pipe barrel, Pipe, which is not clearly marked is subject to rejection. The Contractor shall remove all rejected pipe from the project site within five normal working days.

2-1. PIPE CLASS. The class of ductile iron pipe shall be as indicated in the Ductile Iron Pipe Schedule. The specified class includes service allowance and casting allowance.

Pipe wall thickness for grooved and threaded end pipe shall be increased if necessary to comply with the following minimum thickness:

<u>Pipe Size</u>		<u>Minimum Class</u>	
<u>inches</u>	<u>Mm</u>	<u>Threaded Ends (1)</u>	<u>Grooved Ends (2)</u>
4-16	100-400	53	53
18	450	53	54
20	500	53	55
24	600	53	56
30-54	750-1400	53	--
60 & 64	1500-1600	350	--

(1) Complies with ANSI/AWWA C115/A21.15 for minimum pipe wall thickness for threaded flanges.

(2) Complies with ANSI/AWWA C606 for grooved and shouldered joint ductile iron pipe.

2-2. MATERIALS.

Pipe

Ductile iron, ANSI/AWWA C151/A21.51, Table 1 or Table 3.

Gaskets – All Joint Types

Synthetic rubber; natural rubber will not be acceptable. Gaskets for potable water service shall be certified as suitable at the pipe pressure and for chlorinated and chloraminated potable water; a certificate of gasket suitability shall be submitted. Gaskets shall be furnished by the pipe manufacturer.

Gas and oil-resistant gaskets shall be made of Nitrile (NBR [Acrylonitrile Butadiene]) rubber. The name of the material shall be permanently marked or molded on the gasket. Gaskets shall be certified as suitable where soils may be contaminated with gas and oil products. A certificate of gasket suitability shall be submitted.

Joint Lubricant

Vegetable-based lubricant recommended by the pipe manufacturer. Petroleum or animal-based lubricants will not be acceptable. Lubricants that will be in contact with treated or potable water shall be certified as being in compliance with ANSI/NSF 61.

Fittings

ANSI/AWWA C110/A21.10 (except shorter laying lengths will be acceptable for U.S. Pipe), or ANSI/AWWA C153/A21.53, minimum working pressure rating as follows, unless indicated otherwise on the drawings.

<u>Fitting Size</u> in. [mm]	<u>Material</u>	<u>Type</u>	<u>Min. Working Pressure Rating,</u> psi [kPa]
4 to 24 [100 to 600]	DI	Mechanical and Push-on joints	350 [2,400]
4 to 24 [100 to 600]	DI	Flanged joints	250 [1,700]
30 to 48 [750 to 1,200]	DI	All joints	250 [1,700]
54 to 64 [1,350 to 1,600]	DI	All joints	150 [1,000]

All fittings shall be ductile iron and suitable for a factory test pressure of 100 psi or 1.5 times rated working pressure, whichever is less, without leakage or damage.

Push-on Joints

Restrained Push-on Joints, gaskets with stainless steel gripping segments, (4 inch through 12 inch) [100 mm through 300 mm]

Restrained Push-on Joints, locking wedge type, (4 inch through 24 inch) [100 mm through 600 mm]

Restrained Push-on Joints, positive locking segments and/or rings, (4 inch through 64 inch) [100 mm through 1,600 mm]

ANSI/AWWA C111/A21.11.

American "Fast Grip" or "Field Lok 350 Gasket" manufactured by U.S. Pipe and furnished to licensed Tyton® joint manufacturer.

EBA Iron "Megalug" Series 1700; U.S. Pipe "TR Flex Gripper Ring"; Star Pipe Products "StarGrip 3100"; or American "Field Flex Ring", without exception.

American "Flex-Ring," or "Lok-Ring"; Clow "Super-Lock"; U.S. Pipe "TR Flex"; or Griffin "Snap-Lok."

Flanged Joints

Flanges

Class 250
(where identified)

All Others

ANSI/AWWA C115/A21.15.

Ductile iron, flat faced, with ANSI/ASME B16.1, Class 250 diameter and drilling.

Ductile iron, Class 125, ANSI/AWWA C115/A21.15.

Flanges

All flanges shall be suitable for test pressure of 1.5 times rated pressure without leakage or damage.

Bolts

ASTM A307, chamfered or rounded ends projecting 1/4 to 1/2 inch [6.3 to 12.7 mm] beyond outer face of nut.

Nuts

ASTM A307, hexagonal, ANSI/ASME B18.2.2, heavy semifinished pattern.

Gaskets

ASTM D1330, Grade I rubber, full face type, 1/8 inch [3 mm] thick. Gaskets shall be furnished by the pipe manufacturer. Gaskets for potable water service shall be certified as suitable for chlorinated potable water; a certificate of gasket suitability shall be submitted.

Insulated Flanges

Flanges	As specified herein, except bolt holes shall be enlarged as needed to accept bolt insulating sleeves.
Insulation Kits	As manufactured by Central Plastics or Pipeline Seal and Insulator, Inc.
Insulating Gaskets	Type E, NEMA G-10 glass reinforced epoxy, 1/8 inch [3 mm] thick, with Buna-N sealing element for water and air service. For wastewater service use Viton sealing element. Gaskets shall be furnished by the pipe manufacturer. Gaskets for potable water service shall be certified as suitable for chlorinated potable water; a certificate of gasket suitability shall be submitted.
Bolt Insulating Sleeves	Mylar, 1/32 inch [0.79 mm] thick.
Insulating Washers	Phenolic laminate, 1/8 inch [3 mm] thick, two for each flange bolt.
Backing Washers	Steel, 1/8 inch [3 mm] thick, two for each flange bolt.
Mechanical Joints	ANSI/AWWA C111/A21.11.
Restrained Mechanical Joints (factory prepared spigot), (4 inch through 48 inch) [100 mm through 1,200 mm]	American "MJ coupled Joints", or Griffin "Mech-Lok".
Restrained Mechanical Joints, (field cut spigot), (4 inch through 24 inch) [100 mm through 600 mm]	EBAA Iron "Megalug" Series 1100, or Star Pipe Products "StarGrip Series 3000" without exception.
Wall Pipes or Castings	Mechanical joint with water stop and tapped holes; single casting or fabricated ductile iron pipe; holes sized in accordance with the details on the drawings and provided with removable plugs.
Mechanical Joints with Tie Rods	As indicated on the drawings.
Tie Rods	ASTM A307.
Steel Pipe	ASTM A53, Schedule 40 or 80 as indicated on the drawings.
Washers	ANSI/ASME B18.22.1, plain steel.

Threaded Connections	ANSI/ASME B1.20.1, NPT; with boss or tapping saddle wherever wall thickness minus the foundry tolerance at the tapped connection is less than that required for 4-thread engagement as set forth in Table A.1, Appendix A, of ANSI/AWWA C151/A21.51.
Mechanical Couplings	
Couplings	Dresser "Style 38"; Smith-Blair "r 411 Steel Coupling"; or Romac "Style 400" or "Style 501"; without pipe stop.
Gaskets	Oil-resistant synthetic rubber. Gaskets shall be furnished by the pipe manufacturer. Gaskets for potable water service shall be certified as suitable for chlorinated potable water; a certificate of gasket suitability shall be submitted.
Flanged Adapters	
Restrained (4 inch through 12 inch) [100 mm through 300 mm]	EBA Iron "Megaflange" Series 2100, Ford Star Pipe Products Flange Adapters Series 400.
Dismantling Joints	
Restrained (3 inch and larger [350 mm and larger] - Dismantling Joint)	Romac "DJ400"; Dresser "Style 131 Dismantling Joint" or Viking Johnson. For use in potable water systems, coating to be in accordance with NSF-61. Bolts, nuts, and tie rods shall be stainless steel ASTM A304 or A316.
Unrestrained (14 inch and larger) [350 mm and larger]	Smith-Blair "Type 913" or Romac "Style FC400", 14 inches [350 mm] and larger.
Unless otherwise indicated on the drawings, flanged coupling adapters shall be restrained.	
Tapping Sleeves	Ductile iron, with steel straps and rubber sealing gasket, 250 psi [1,700 kPa] pressure rating.
Watertight/Dusttight Pipe Sleeves	PSI "Thunderline Link-Seal", insulating type with modular rubber sealing elements, nonmetallic pressure plates, and 316 stainless steel bolts and nuts.

Shop Coating and Lining

Cement Mortar Lining with Seal Coat	ANSI/AWWA C104/A21.4.
Ceramic Epoxy Lining (exterior piping)	Induron "Protecto 401 Ceramic Epoxy".
Glass Lining	Two-coat system applied over blast-cleaned surface; ground and finish coats separately fired; finished lining thickness at least 8 mils [200 μm], Mohs' Hardness 5 to 6 density [2,500 to 3,000 kg/m ³] as determined by ASTM D792; Fast Fabricators, Inc. "MEH 32" or "SG-14".
Universal Primer	Manufacturer's standard. If in contact with treated or potable water, certify as being in compliance with ANSI/NSF 61.
Asphaltic Coating	Manufacturer's standard.
Coal Tar Epoxy	Manufacturer's standard.
Liquid Epoxy	ANSI/AWWA C210, non-coal tar modified, or when in contact with treated or potable water, certify as being in compliance with ANSI/NSF 61.
Medium Consistency Coal Tar	Carboline "Bitumastic 50" or Tnemec "46-465 H.B. Tnemecol."

2-3. SHOP COATING AND LINING. The interior of all pipe and fittings, unless noted otherwise, shall be ceramic epoxy lined.

The exterior surfaces of all pipes and fittings which will be above grade and exposed to the elements, shall be shop primed. Flange faces shall be coated with a suitable rust preventive compound. Exterior surfaces of all other pipe and fittings shall be coated with asphaltic coating.

PART 3 - EXECUTION

3-1. INSPECTION. Pipe and fittings shall be carefully examined for cracks and other defects immediately before installation; pipe ends shall be examined with particular care. All defective pipe and fittings shall be removed from the site.

3-2. PREPARATION. The interior of all pipe and fittings shall be thoroughly cleaned of all foreign matter prior to installation. Before jointing, all joint contact surfaces shall be wire brushed if necessary, wiped clean, and kept clean until jointing is completed.

Precautions shall be taken to prevent foreign material from entering the pipe during installation. Debris, tools, clothing, or other objects shall not be placed in or allowed to enter the pipe.

3-3. CUTTING PIPE. Cutting shall be done in a neat manner, without damage to the pipe or the lining. Cuts shall be smooth, straight, and at right angles to the pipe axis. After cutting, the ends of the pipe shall be dressed with a file or a power grinder to remove all roughness and sharp edges. The cut ends of push-on joint pipe shall be suitably beveled.

All field cutting of existing gray cast iron pipe shall be done with mechanical pipe cutters, except where the use of mechanical cutters would be difficult or impracticable.

Contractor shall use factory prepared pipe ends unless a field cut is required for connections.

Ends of ductile iron pipe shall be cut with a portable guillotine saw, abrasive wheel, saw, milling cutter, or oxyacetylene torch. The use of hydraulic squeeze type cutters will not be acceptable. Field-cut holes for saddles shall be cut with mechanical cutters; oxyacetylene cutting will not be acceptable.

3-4. ALIGNMENT. Piping shall be laid to the lines and grades indicated on the drawings. Pipelines or runs intended to be straight shall be laid straight. Deflections from a straight line or grade shall not exceed the values stipulated in Table 3 or Table 4 of AWWA C600, unless specially designed bells and spigots are provided.

Either shorter pipe sections or fittings shall be installed where needed to conform to the alignment or grade indicated on the drawings.

3-5. LAYING PIPE. Buried pipe shall be protected from lateral displacement by placing the specified pipe embedment material installed as specified in the Trenching and Backfilling section. Under no circumstances shall pipe be laid in water, and no pipe shall be laid under unsuitable weather or trench conditions.

Whenever pipe laying is stopped, the open end of the pipe shall be sealed with a watertight plug, which will prevent trench water from entering the pipe.

Pipe shall be laid with the bell ends facing the direction of laying, except where reverse laying is specifically acceptable by Engineer.

3-6. FIELD JOINTS. Joints in buried and tunnel locations shall be mechanical or push-on type unless otherwise indicated on the drawings or where required to connect to existing piping or to valves. Bells on wall castings and wall sleeves shall be mechanical joint type, with tapped holes for tie rods or stud bolts. All other joints shall be flanged unless otherwise indicated on the drawings.

Certification of joint design shall be provided in accordance with ANSI/AWWA C111/A21.11, Section 4.5, Performance Requirements, as modified herein. The joint test pressure shall be not less than 2 times the working pressure or 1-1/2 times the test pressure of the pipeline, whichever is higher. The same certification and testing shall also be provided for restrained joints. For restrained joints, the piping shall not be blocked to prevent separation and the joint shall not leak or show evidence of failure. It is not necessary that such tests be made on pipe manufactured

specifically for this project. Certified reports covering tests made on other pipe of the same size and design as specified herein and manufactured from materials of equivalent type and quality may be accepted as adequate proof of design.

Restrained joints shall be extended after they are assembled to minimize further take-up.

Field closure pieces shall be located away from the bends beyond the length over which joints are to be restrained.

3-7. MECHANICAL JOINTS. Mechanical joints shall be carefully assembled in accordance with the manufacturer's recommendations. If effective sealing is not obtained, the joint shall be disassembled, thoroughly cleaned, and reassembled. Bolts shall be uniformly tightened to the torque values listed in Appendix A of ANSI/AWWA C111/A21.11. Over tightening of bolts to compensate for poor installation practice will not be acceptable.

The holes in mechanical joints with tie rods shall be carefully aligned to permit installation of the tie rods. In flange and mechanical joint pieces, holes in the mechanical joint bells and the flanges shall straddle the top (or side for vertical piping) centerline. The top (or side) centerline shall be marked on each flange and mechanical joint piece at the foundry.

3-8. PUSH-ON JOINTS. The pipe manufacturer's instructions and recommendations for proper jointing procedures shall be followed. All joint surfaces shall be lubricated with a soap solution provided by the pipe manufacturer immediately before the joint is completed. Lubricant shall be suitable for use in potable water, shall be stored in closed containers, and shall be kept clean. Each spigot end shall be suitably beveled to facilitate assembly.

Pipe ends for restrained joint pipe shall be prepared in accordance with the pipe manufacturer's recommendations.

3-9. FLANGED JOINTS. Pipe shall extend completely through screwed-on flanges. The pipe end and flange face shall be finish machined in a single operation. Flange faces shall be flat and perpendicular to the pipe centerline.

When bolting flanged joints, care shall be taken to avoid restraint on the opposite end of the pipe or fitting which would prevent uniform gasket compression or would cause unnecessary stress in the flanges. One flange shall be free to move in any direction while the flange bolts are being tightened. Bolts shall be tightened gradually and at a uniform rate, to ensure uniform compression of the gasket.

Special care shall be taken when connecting piping to any pumping equipment to ensure that piping stresses are not transmitted to the pump flanges. All connecting piping shall be permanently supported to obtain accurate matching of bolt holes and uniform contact over the entire surface of flanges before any bolts are installed in the flanges. Pump connection piping shall be free to move parallel to its longitudinal centerline while the bolts are being tightened. Each pump shall be leveled, aligned, and wedged into position which will fit the connecting piping, but shall not be grouted until the initial fitting and alignment of the pipe, so that the pump may be shifted on its foundation if necessary to properly install the connecting piping. Each

pump shall, however, be grouted before final bolting of the connecting piping. After final alignment and bolting, the pump connections shall be tested for applied piping stresses by loosening the flange bolts which, if the piping is properly installed, should result in no movement of the piping relative to the pump or opening of the pump connection joints. If any movement is observed, the piping shall be loosened and re-aligned as needed and then the flanges bolted back together. The flange bolts shall then be loosened and the process repeated until no movement is observed.

3-10. FLANGED COUPLING ADAPTERS. Flanged coupling adapters shall be installed in strict accordance with the coupling manufacturer's recommendations. After the pipe is in place and bolted tight, the proper locations of holes for the anchor studs shall be determined and the pipe shall be field-drilled. Holes for anchor studs shall be drilled completely through the pipe wall. Hole diameter shall be not more than 1/8 inch [3 mm] larger than the diameter of the stud projection. Unless indicated on the drawings, all flange coupling adapters shall be restrained.

The inner surfaces of couplings shall be prepared for coating in accordance with instructions of the coating manufacturer and shall then be coated with liquid epoxy in accordance with ANSI/AWWA C210. The remaining surfaces, except flange mating surfaces, shall be cleaned and shop primed with universal primer.

3-11. DISMANTLING JOINTS. Dismantling joints shall be provided for restrained coupling 14 inch and larger and where indicated on the drawings and as specified herein. Dismantling joints shall comply with AWWA C219 and shall be restrained flange by flange couplings manufactured as a single unit. Dismantling joints shall be installed in accordance with the manufacturer's recommendations.

3-12. MECHANICAL COUPLINGS. Mechanical couplings shall be carefully installed in accordance with the manufacturer's recommendations. A space of at least 1/4 inch [6 mm], but not more than 1 inch [25 mm], shall be left between the pipe ends. Pipe and coupling surfaces in contact with gaskets shall be clean and free from dirt and other foreign matter during assembly. All assembly bolts shall be uniformly tightened so that the coupling is free from leaks, and all parts of the coupling are square and symmetrical with the pipe. Following installation of the coupling, damaged areas of shop coatings on the pipe and coupling shall be repaired to the satisfaction of Engineer.

The interior surfaces of the middle rings shall be prepared for coating in accordance with instructions of the coating manufacturer and shall then be coated with liquid epoxy in accordance with ANSI/AWWA C210. The remaining components shall be cleaned and shop primed with universal primer.

3-13. GROOVED-END JOINTS. Not used.

3-14. POLYETHYLENE ENCASEMENT. Not used.

3-15. OUTLETS. Where a 12 inch [300 mm] or smaller branch outlet is indicated and the diameter of the parent pipe is at least twice the diameter of the branch, a tee, a factory welded-on boss, or a tapping saddle will be acceptable.

Where a 4 inch [100 mm] or larger branch outlet is indicated on the drawings and the diameter of the branch pipe for a given diameter of parent pipe is less than equal to the maximum diameter listed herein, a factory welded-on outlet fabricated from centrifugally cast ductile iron pipe will be acceptable.

Parent Pipe Diameter Versus Maximum Branch Pipe
Diameter for Welded-On Outlets

<u>Parent Pipe Dia</u> inches [mm]	<u>Max Branch Pipe Dia</u> inches [mm]	<u>Parent Pipe Dia</u> inches [mm]	<u>Max Branch Pipe Dia</u> inches [mm]
8 [200]	4 [100]	30 [750]	20 [500]
10 [250]	6 [150]	36 [900]	24 [600]
12 [300]	8 [200]	42 [1050]	30 [750]
14 [350]	8 [200]	48 [1200]	30 [750]
16 [400]	10 [250]	54 [1350]	36 [900]
18 [450]	12 [300]	60 [1500]	36 [900]
20 [500]	14 [350]	64 [1600]	36 [900]
24 [600]	16 [400]		

All 30 inch [750 mm] and smaller branch pipe diameter welded-on outlets shall be rated for a working pressure of 250 psi [1,700 kPa], 36 inch [900 mm] branch diameter welded-on outlets shall be rated for a working pressure of 200 psi [5,000 kPa], and all outlets shall have a minimum factor of safety of 2.0. The pipe manufacturer shall provide test data and certification of proof of design. It is not necessary that these tests be performed on pipe manufactured specifically for this project. Certified reports covering tests made on other pipe of the same size and design as specified herein and manufactured from materials of equivalent type and quality may be accepted as adequate proof of design. Welded-on outlets may be provided as a radial (tee) outlet, a tangential outlet, or a lateral outlet fabricated at a specific angle to the parent pipe (in 15 degrees [0.262 rad] increments between 45 degrees and 90 degrees [0.785 to 1.570 rad] from the axis of the parent pipe), as indicated on the drawings. The fillet weld dimensions for welded-on outlets shall be as specified herein. Parent pipe and branch pipe shall meet hydrostatic test requirements in accordance with ANSI/AWWA C151/A21.51, Sec. 5.2, prior to fabrication.

Welded-on Outlet Fillet Weld Dimensions for Specified
Outlet Configurations

<u>Radial and Lateral Outlets</u>			<u>Tangential Outlets</u>		
<u>Parent Pipe Dia</u> inches [mm]	<u>Branch Pipe Dia</u> inches [mm]	<u>Weld Fillet Size</u> inches [mm]	<u>Parent Pipe Dia</u> inches [mm]	<u>Branch Pipe Dia</u> inches [mm]	<u>Weld Fillet Size</u> inches [mm]
24 [600] and	24 [600] and	1 x 1	8-30	24 [600] and	1-1/4 x 1-1/4

Welded-on Outlet Fillet Weld Dimensions for Specified
Outlet Configurations

<u>Radial and Lateral Outlets</u>			<u>Tangential Outlets</u>		
<u>Parent Pipe Dia</u>	<u>Branch Pipe Dia</u>	<u>Weld Fillet Size</u>	<u>Parent Pipe Dia</u>	<u>Branch Pipe Dia</u>	<u>Weld Fillet Size</u>
inches [mm]	inches [mm]	inches [mm]	inches [mm]	inches [mm]	inches [mm]
smaller	smaller	[25 x 25]	[200-750]	smaller	[32 x 32]
30-48 [750-1200]	24 [600] and smaller	1-1/4 x 1-1/4 [32 x 32]	36-54 [900-1350]	24 [600] and smaller	1-1/2 x 1-1/2 [38 x 38]
54-64 [1350-1600]	24 [600] and smaller	2-1/4 x 2-1/2 [57 x 64]	60-64 [1500-1600]	24 [600] and smaller	2-1/2 x 2-1/2 [64 x 64]
42-64 [1050-1600]	30 [750]	2-1/2 x 2-1/2 [64 x 64]	42-54 [1050-1350]	30 [750]	2-1/2 x 2-1/2 [64 x 64]
54-64 [1350-1600]	36 [900]	2-3/4 x 2-3/4 [70 x 70]	60-64 [1500-1600]	30 [750]	2-3/4 x 2-3/4 [70 x 70]

All joints on welded-on branch outlets shall be made in accordance with the latest revision of ANSI/AWWA C111/A21.11 and/or ANSI/AWWA C115/A21.15, as applicable. All outlets shall be fabricated from centrifugally cast ductile iron pipe designed in accordance with ANSI/AWWA C150/A21.50 and manufactured and tested in accordance with ANSI/AWWA C151/A21.51. Ni-Rod FC 55[®] electrodes manufactured by International Nickel Corporation (or an electrode with equivalent properties) shall be used in the manufacture of the fillet welds. Carbon steel electrodes will not be acceptable. Special Thickness Class 53 pipe shall be used for all branch pipe and parent pipe in 4 to 54 inch [100 to 1350 mm] sizes. Pressure Class 350 pipe shall be used for 60 inch and 64 inch [1,500 and 1,600 mm] parent pipe. After welding, each fabricated outlet shall be subjected to a 15 psi [100 kPa] air test. A soap and water solution shall be applied during the testing procedure to inspect the weld for leakage. Any welds that show air seepage shall be refabricated and retested.

Welded-on outlets shall be fabricated by the pipe manufacturer at its production facilities. Manufacturers of welded-on outlets shall have at least 5 years of satisfactory experience in the manufacture and performance of these products. The manufacturer shall have a documented welding quality assurance system and shall maintain resident quality assurance records based on ANSI/AWS D11.2, the Guide for Welding Iron Castings. The manufacturer shall also maintain appropriate welding procedure specifications (WPS) and procedure qualification (PQR), and welder performance qualification test (WPQR) records.

The type of pipe end for the branch outlet shall be as specified or indicated on the drawings. The maximum size and laying length of the welded-on branch outlet shall be as recommended by the pipe manufacturer and shall be acceptable to Engineer for the field conditions and the connecting pipe or valve. Pipe embedment material and trench backfill shall be placed and compacted under and around each side of the outlet to hold the pipe in proper position and alignment during the subsequent pipe jointing, embedment, and backfilling.

At locations acceptable to Engineer, drilling and tapping of the pipe wall for 2 inch [50 mm] and smaller pipe connections will also be acceptable, provided that the wall thickness, minus the casting allowance, at the point of connection equals or exceeds the wall thickness required for 4-thread engagement in accordance with Table A.1, Appendix A of ANSI/AWWA C151/A21.51.

3-16. WALL PIPES OR CASTINGS. Wall pipes or castings shall be provided where ductile iron pipes pass through concrete walls, unless otherwise indicated on the drawings.

Where a flange and mechanical joint piece is to connect to a mechanical joint wall pipe or casting, the bolt holes in the bell of the wall pipe or casting shall straddle the top (or the side for vertical piping) centerline of the pipe or casting and shall align with the bolt holes in the flange and mechanical joint piece. The top centerline shall be marked on the wall pipe or casting at the foundry.

3-17. REDUCERS. Reducers shall be eccentric or concentric as indicated on the drawings. Reducers of eccentric pattern shall be installed with the straight side on top, so that no air traps are formed.

3-18. CONNECTIONS WITH EXISTING PIPING. Connections between new work and existing piping shall be made using fittings suitable for the conditions encountered. Each connection with an existing pipe shall be made at a time and under conditions which will least interfere with service to customers, and as authorized by Owner. Facilities shall be provided for proper dewatering and for disposal of all water removed from dewatered lines and excavations without damage to adjacent property.

Special care shall be taken to prevent contamination when dewatering, cutting into, and making connections with existing potable water piping. Trench water, mud, or other contaminating substances shall not be permitted to enter the lines. The interior of all pipe, fittings, and valves installed in such connections shall be thoroughly cleaned and then all potable water pipe, fittings, and valves shall be swabbed with, or dipped in, a 200 mg/L chlorine solution.

3-19. INSULATED FLANGED JOINTS. Insulated flanged joints shall be installed where indicated on the drawings. In addition to one full-faced insulated gasket, each flange insulating assembly shall consist of one full-length sleeve, two insulating washers, and two backing washers for each flange bolt. The insulating gasket ID shall be 1/8 inch [3 mm] less than the ID of the flange in which it is installed. The insulated flanged joint accessories shall be installed in accordance with the instructions and recommendations of the manufacturer.

3-20. CONCRETE ENCASEMENT. Concrete encasement shall be installed where indicated on the drawings. A pipe joint shall be provided within 12 inches [300 mm] of each end of the concrete encasement. Concrete and reinforcing steel shall be as specified in the Cast-in-Place Concrete section. All pipe to be encased shall be suitably supported and blocked in proper position, and shall be anchored to prevent flotation.

3-21. REACTION ANCHORAGE AND BLOCKING. Concrete blocking shall be installed where indicated on the drawings. The blocking size shall be of the dimensions indicated on the drawings, shall extend from the fitting to solid, undisturbed earth, and shall be so installed that all joints are accessible for repair. If adequate support against undisturbed ground cannot be obtained, restrained joints shall be installed to provide the necessary support. If the lack of suitable solid vertical excavation face is due to improper trench excavation, restrained joints shall be furnished and installed by and at the expense of Contractor.

Reaction blocking, anchorages, or other supports for fittings installed in fills or other unstable ground, installed above grade, or exposed within structures, shall be provided as indicated on the drawings.

Coatings for the appurtenances listed below shall be as specified in the Protective Coatings section, or if a Protective Coatings section is not included, shall be as specified below.

All ferrous metal clamps, rods, bolts, and other components of tapping saddles, reaction anchorages, or joint harness, subject to submergence or in contact with earth or other fill material and not encased in concrete, shall be protected from corrosion by two coats of medium consistency coal tar applied in the field to clean, dry metal surfaces. The first coat shall be dry and hard before the second coat is applied. Metal surfaces exposed above grade or within structures shall be given one prime coat and two finish coats of a coating acceptable to Engineer.

3-22. PRESSURE AND LEAKAGE TESTS. Pipe and fittings shall be subjected to a pressure test and a leakage test in accordance with the Pipeline Pressure and Leakage Testing section.

Pipe and fittings shall be subjected to a pressure test and a leakage test. The Contractor shall provide all necessary pumping equipment; piping connections between the piping and the nearest available source of test water; pressure gauges; and other equipment, materials, and facilities necessary for the tests.

All pipe, fittings, valves, pipe joints, and other materials which are found to be defective shall be removed and replaced with new and acceptable materials, and the affected portion of the piping shall be retested by and at the expense of Contractor.

All joints shall be watertight and free from visible leaks. Any visible leak which is discovered within the correction period stipulated in the General Conditions shall be repaired by and at the expense of Contractor.

3-23. CLEANING. The interior of all pipe and fittings shall be kept clean of any foreign matter until the work has been accepted.

End of Section

This page was left blank intentionally

This page was left blank intentionally

Section 15064

STAINLESS STEEL PIPE, TUBING, AND ACCESSORIES

PART 1 - GENERAL

1-1. SCOPE. This section covers the furnishing of stainless steel pipe, tubing and accessories for the services as indicated herein. Pipe and tubing shall be furnished complete with all fittings, flanges, unions, and other accessories specified herein.

1-2. SUBMITTALS.

1-2.01. Drawings and Data. Complete specifications, data, and catalog cuts or drawings shall be submitted in accordance with the Submittals section. Submittals are required for all piping, fittings, gaskets, sleeves, and accessories, and shall include the following data:

Name of Manufacturer
Type and model
Construction materials, thickness, and finishes
Pressure and temperature ratings

Contractor shall obtain and submit a written statement from the gasket material manufacturer certifying that the gasket materials are compatible with the joints specified herein and are recommended for the specified field test pressures and service conditions.

1-3. DELIVERY, STORAGE, AND HANDLING. Shipping shall be in accordance with the Shipping section. Handling and storage shall be in accordance with the Handling and Storage section. All materials shall be stored in a sheltered location above the ground, separated by type, and shall be supported to prevent sagging or bending.

PART 2 - PRODUCTS

2-1. MATERIALS. Stainless steel pipe materials shall be as specified herein.

2-1.01. Material Classification SS-1. Not used.

2-1.02. Material Classification SS-2. Not used.

2-1.03. Material Classification SS-3. Not used.

2-1.04. Material Classification SS-4.

SS-4 – Schedule 40S with Beveled Ends	Pipe Fittings	ASTM A312, Grade TP316L. Buttwelded, ASTM A403, WP316L. Fittings shall conform to ANSI/ASME B16.9, Schedule 40S with beveled ends.
Pipe Sleeves		
2-1/2 inch and larger.		

2-1.05. Material Classification SS-5.

SS-5 – Schedule 40S with Flanged Ends	Pipe Fittings	ASTM A312, Grade TP316L. Flanged, ASTM A403 and ASTM A774, WP316L. Fittings shall conform to ANSI/ASME B16.9, Schedule 40S.
Piping in wetwells.		
2-1/2 inch and larger.		

2-1.06. Material Classification SS-6. Not used.

2-1.07. Material Classification SS-7. Not used.

2-1.08. Material Classification SS-8. Not used.

2-1.09. Material Classification SS-9. Not used.

2-1.10. Accessory Materials. Accessory materials for the stainless steel pipe systems shall be as indicated.

SS-5 Pipe Flanges	ANSI/ASME B16.5, Class 150, flat faced, AISI Type 316L, to match piping.
Flange Bolts	ASTM A193 Class 2, AISI Type 316, ANSI B18.2.1, heavy hex head, length such that, after installation, the bolts will project 1/8 to 3/8 inch [3 to 10 mm] beyond outer face of the nut.
Flange Nuts	ASTM A194, AISI Type 316, ANSI/ASME B18.2.2, heavy hex pattern.
Flange Gaskets	ASTM D1330, Grade I, red rubber, ring type, 1/3 inch thick. Gaskets shall be furnished by the pipe manufacturer.

2-2. WELDING OF STAINLESS STEEL. Filler metal for welding austenitic stainless steel, P-number 8 base materials shall be in accordance with the following:

Material Type/Grade 316L shall use Type 316L filler metal.

The following requirements shall apply when fabricating austenitic stainless steel components.

Grinding shall be by aluminum oxide, zirconium oxide, or silicon carbide grinding wheels that shall not have been used on carbon or low alloy steels. Hand or power wire brushing shall be by stainless steel brushes that shall not have been used on carbon or low alloy steels. All tools used in fabrication shall be protected to minimize contact with steel alloys or free iron. Grinding wheels and brushes shall be identified and controlled for their use on these materials only to ensure that contamination of these materials does not occur.

Antispatter compounds, marking fluids, marking pens, tape, temperature indicating crayons, and other tools shall have a total halogen content of less than 200 parts per million.

Heat input control for welding shall be specified in the applicable WPS and shall not exceed 55,000 joules per inch (22,000 joules per cm) as determined by the following formula:

$$\text{Heat Input (J/in.)} = \frac{\text{Voltage} \times \text{Amperage} \times 60}{\text{Travel Speed (in./min.)}}$$

Complete penetration pressure retaining welds shall be made using the GTAW process for the root and second layer as a minimum.

Austenitic stainless steel instrument tubing shall be welded using only the GTAW process.

Socket welds or butt welds in all austenitic stainless steel instrument tubing lines shall require an inert gas backing (purge) using argon during welding to avoid oxidation.

The application of heat to correct weld distortion and dimensional deviation without prior written approval from the Engineer is prohibited.

Unless otherwise approved in writing, the GTAW process shall require the addition of filler metal.

The maximum preheat and interpass temperature for austenitic stainless steel shall be 350° F (176° C). The minimum preheat temperature shall be 50° F (10° C).

Complete joint penetration welds welded from one side without backing, weld repairs welded from one side without backing, or weld repairs in which the base metal remaining after excavation is less than 0.1875 inch (5 mm) from being through wall, which are fabricated from austenitic stainless steel ASME P-number 8 base metal or unassigned metals with similar chemical compositions, shall have the root side of the weld purged with an argon backing gas prior to welding. Backing gas (purge) shall only be argon. The argon backing gas shall be classified as welding grade argon or shall meet Specification SFA-5.32, AWS Classification SG-A. The backing gas (purge) shall be maintained until a minimum of two layers of weld metal have been deposited.

2-3. SHOP CLEANING AND PICKLING OF STAINLESS STEEL PIPING AND WELDS. All stainless steel piping shall be thoroughly cleaned and pickled at the mill in accordance with ASTM A380.

Pickling shall produce a modest etch and shall remove all embedded iron and heat tint. After fabrication, pickled surfaces shall be subjected to a 24 hour water test or a ferroxyl test to detect the presence of residual embedded iron. All pickled surfaces damaged during fabrication including welded areas shall either be mechanically cleaned or repickled or passivated in accordance with ASTM A380. Materials that have been contaminated with steel alloys or free iron shall not be used until all contamination is removed. When cleaning to remove steel or iron contamination is required, it shall be performed in accordance with ASTM A380, Code D requirements. Mechanical cleaning is not an acceptable cleaning method for oxygen or ozone piping. Oxygen and ozone piping shall be repickled or passivated as specified herein. All stainless steel surfaces shall be adequately protected during fabrication, shipping, handling, and installation to prevent contamination from iron or carbon steel objects or surfaces. Particulate matter shall be removed from piping and welds. Labels shall be affixed to the piping sections to indicate shop cleaning has been performed. Welds shall be either mechanically cleaned, pickled, or passivated on the exterior of the pipe.

For oxygen or ozone piping, welds shall be pickled or passivated on the interior and exterior of the pipe.

2-4. HIGH TEMPERATURE EPOXY COATING. Not used.

2-5. INSULATING FITTINGS. In all piping except air and gas piping, insulating fittings shall be provided to prevent contact of dissimilar metals, including but not limited to, contact of copper, brass, or bronze pipe, tubing, fittings, valves, or appurtenances, or stainless steel pipe, tubing, fittings, valves, or appurtenances with iron or steel pipe, fittings, valves, or appurtenances. Insulating fittings shall also be provided to prevent contact of copper, brass, or bronze pipe, tubing, fittings, valves or appurtenances with stainless steel pipe, tubing, fittings, valves, or appurtenances.

PART 3 - EXECUTION

3-1. INSTALLATION. Materials furnished under this section will be installed in accordance with the Miscellaneous Piping and Accessories Installation section.

End of Section

MISCELLANEOUS STEEL PIPE, TUBING, AND ACCESSORIES

PART 1 - GENERAL

1-1. SCOPE. This section covers the furnishing of miscellaneous steel pipe, tubing and accessories that for pipe diameters 24 inches [600 mm] and smaller. Pipe and tubing shall be furnished complete with all fittings, flanges, unions, and other accessories specified herein.

1-2. GENERAL.

1-2.01. General Equipment Stipulations. The General Equipment Stipulations shall apply to all equipment furnished under this section. If requirements in this specification differ from those in the General Equipment Stipulations, the requirements specified herein shall take precedence.

1-3. SUBMITTALS.

1-3.01. Drawings and Data. Complete specifications, data, and catalog cuts or drawings shall be submitted in accordance with the Submittals section. Submittals are required for all piping, fittings, gaskets, sleeves, and accessories, and shall include the following data:

Name of Manufacturer
Type and model
Construction materials, thickness, and finishes
Pressure and temperature ratings

Contractor shall obtain and submit a written statement from the gasket material manufacturer certifying that the gasket materials are compatible with the joints specified herein and are recommended for the specified field test pressures and service conditions.

1-4. DELIVERY, STORAGE, AND HANDLING. Shipping shall be in accordance with the Shipping section. Handling and storage shall be in accordance with the Handling and Storage section. All materials shall be stored in a sheltered location above the ground, separated by type, and shall be supported to prevent sagging or bending.

1-4.01. Coated Pipe. Handling methods and equipment used shall prevent damage to the protective coating and shall include the use of end hooks, padded calipers, and nylon or similar fabric slings with spreader bars. Bare cables, chains, or metal bars shall not be used. Coated pipe shall be stored off the ground on wide, padded skids. Plastic coated pipe shall be covered or otherwise protected from exposure to sunlight.

PART 2 - PRODUCTS

2-1. GALVANIZED STEEL PIPE.

Galvanized steel pipe materials and service shall be as specified herein.

2-1.01. Material Classification CSG-1. Not used.

2-1.02. Material Classification CSG-2.

CSG-2 – Standard Weight Galvanized Steel with Threaded Fittings Grease piping – pumping units. Sump pump discharge piping in interior locations except where buried. Filtrate piping. Drain piping from equipment.	Pipe	ASTM A53, Type E, standard weight, Grade A or B; or ASTM A106, of equivalent thickness, galvanized.
	Fittings	Malleable iron threaded, galvanized. Fittings shall conform to ANSI/ASME B16.3, Class 150, or Fed Spec WW-P-521, Type II.

2-1.03. Material Classification CSG-3. Not used.

2-1.04. Accessory Materials. Accessory materials for galvanized steel pipe shall be as indicated in the Steel Pipe section of the specification.

2-2. STEEL PIPE. Steel pipe materials and service shall be as specified herein.

2-2.01. Material Classification CS-1. Not used.

2-2.02. Material Classification CS-2. Not used.

2-2.03. Material Classification CS-3.

CS-3 – Standard Weight Steel with Buttwelded Fittings. Diesel fuel piping outdoors above grade. Fuel oil or diesel fuel piping in interior locations or outdoors above grade. 2-1/2 inch and larger.	Pipe	ASTM A53, Type S, standard weight Grade B; or ASTM A106, of equivalent thickness. Bevel ends. Buttwelded. Fitting shall conform to ANSI/ASME B16.9, standard weight.
	Fittings	

2-2.04. Material Classification CS-4.

CS-4 – Extra Strong Steel with Threaded Fittings. Fuel oil or diesel fuel piping in interior locations or outdoors above grade. 2 inch and smaller.	Pipe	ASTM A53, Type S, extra strong, Grade B; or ASTM A106, of equivalent thickness. Threaded ends.
	Fittings	Forged steel, threaded. Fittings shall conform to

	ANSI B16.11, Class 2000 or 3000; Bonney, Crane, Ladish, or Vogt.
--	--

- 2-2.05. Material Classification CS-5. Not used.
- 2-2.06. Material Classification CS-6. Not used.
- 2-2.07. Material Classification CS-7. Not used.
- 2-2.08. Material Classification CS-8. Not used.
- 2-2.09. Material Classification CS-9. Not used.
- 2-2.10. Material Classification CS-10. Not used.
- 2-2.11. Material Classification CS-11. Not used.
- 2-2.12. Material Classification CS-12. Not used.
- 2-2.13. Material Classification CS-13. Not used.
- 2-2.14. Material Classification CS-14. Not used.
- 2-2.15. Accessory Materials. Accessory materials for the miscellaneous steel pipe and tubing systems shall be as indicated.

Nipples	ASTM A733, seamless, extra strong (Schedule 80); "close" nipples will be permitted only by special authorization in each case.
Unions (Malleable Iron)	Fed Spec WW-U-531, Class 2; Type B (galvanized) for galvanized pipe or Type A (black) for ungalvanized pipe.
Flanges	
Standard Weight Pipe	ANSI/ASME B16.5, Class 150, flat faced when connected to flat faced flanges; otherwise, raised face.
Extra Strong Pipe	
Chemical Gas Piping	ASTM A105, forged steel, tongue and groove flanged union type, with nonmetallic gasket; rated for a working pressure of 1,500 psi [10.3 MPa].
Other services	ANSI/ASME B16.5, Class 300, raised face.
Plastic Lined Pipe	Steel, forged or cast, diameter and drilling in accordance with ANSI/ASME B16.5, Class 150

or 300 as required.

Flange Bolts and Nuts

ASTM A193, Grade B7 with ASTM A194 Grade 2H nuts. Length such that, after installation, the bolts will project 1/8 to 3/8 inch [3 to 10 mm] beyond outer face of the nut.

Flange Gaskets

For Process Air Service

Raised Face Flanges

Non-asbestos inorganic fiber with EPDM binder; dimensions to suit flange contact face, 1/16 inch [1.5 mm] minimum thickness for plain finished surfaces, 3/32 inch [2 mm] minimum thickness for serrated surfaces, rated for 275°F [135°C] service; Garlock "IFG 5507".

Flat Faced Flanges

Premium Grade, EPDM, full face for 12 inch [300 mm] and smaller ring type for 14 inch [350 mm] and larger, 1/8 inch [3 mm] thick, rated for 275°F [135°C] service; Garlock "8314".

For Boiler Exhaust Service

Garlock "Blue-Gard, Style 3000".

For Oil Service

Non-asbestos filler with neoprene or nitrile binder; dimensions to suit flange contact face; 1/16 inch [1.5 mm] minimum thickness for plain finished surfaces, 3/32 inch [2 mm] minimum thickness for serrated surfaces.

For Heating Water Service

Non-asbestos inorganic fiber with nitrile binder; dimensions to suit flange contact face, 1/16 inch [1.5 mm] minimum thickness for plain finished surfaces, 3/32 inch [2 mm] minimum thickness for serrated surfaces; Garlock "IFG 5500".

For Water Service

ASTM D1330, Grade I, red rubber, ring type, 1/8 inch [3 mm] thick.

For Chemical Service

Suitable for chemical.

For Other Services

Flat Faced Flanges

Non-asbestos filler with neoprene or nitrile binder; dimensions to suit flange contact face; 1/16 inch [1.5 mm] minimum thickness for plain finished surfaces, 3/32 inch [2 mm] minimum thickness for serrated surfaces.

Raised Face Flanges

Continuous stainless steel ribbon wound into a spiral with non-asbestos filler between adjacent coils with a carbon steel gauge ring. Compressed gasket thickness shall be

0.095 inch ±0.005 inch [2.4 mm ±0.13 mm].

Grooved Couplings

Rigid AWWA C606; Gustin-Bacon "No. 120 Rigid" or Victaulic "07 Zero-Flex".

Standard AWWA C606; Gustin-Bacon "No. 100 Standard" or Victaulic "Style 77".

Mechanical Couplings Dresser "Style 38" or Smith-Blair "Type 411 Flexible Coupling"; without pipe stop.

Expansion Joints

Process air Expansion joints shall be the elastomeric, arched type and shall be Mercer "Type 450" with "Type 500" retaining rings and Kevlar reinforcement, or equal.

The number of arches shall be as indicated on the drawings. The connection shall be suitable for a maximum pressure of 15 psig [105 kPa gauge] and maximum temperature of 250 F [122 C]. Expansion joints shall have the following ratings:

Number of Arches: 1
Spring rate: ___ lbs/inch
Movement: ___ inch

Number of Arches: 2
Spring rate: ___ lbs/inch
Movement: ___ inch

Number of Arches: 3
Spring rate: ___ lbs/inch
Movement: ___ inch

Heating water, chilled water, and other services not specified. Flexonics "Model H Expansion Compensators" for 3 inch [75 mm] or smaller; Flexonics "Mid-Corr, Series MCB" with flanged ends and stainless steel bellows for 4 inch [100 mm] or larger. Expansion joints shall be suitable for working pressures up to 150 psig [1035 kPa].

Material Classification CS-14: Double wall pipe with leak detection.

Joining Carrier pipe shall be joined by socket welding. Containment pipe shall be joined by split sleeve of the same diameter as containment pipe with minimum 60 mil [1.5 mm] thick polyethylene jacket.

End Seal End seals shall be furnished at all terminal ends. The end seal shall be sealed to the containment pipe.

Leak Detection Microprocessor based monitoring unit, for continuous monitoring by cable of a single line for water and

hydrocarbon.

Control Panel	Modified NEMA Type 12 enclosure, with Status and Alarm Data Model "PAL-AT20C". Power supply to the unit will be 120 volt, 1 phase, 60 Hz. Unit shall be UL listed with alarm horn and shall locate leaks and not depend on battery back-up functions. System conditions shall be stored in memory in the event of power failure and shall automatically resume monitoring without reset once power is available. Monitoring unit shall be able to differentiate between water left in pipe during installation and an actual growing leak. Panel shall also be able to detect a break in sensor cable and its location.
Cable	Cable shall be located in the interstitial space between the carrier and containment pipe, shall detect both water and hydrocarbon, and shall be capable of being dried in place without being replaced after exposure to any fluid Type "AGW-Gold". Coaxial cable shall interface monitoring control panel with sensor cable by utilizing waterproof junction box for protecting connection.

2-3. COATINGS. Standard weight steel pipe in buried locations, except hot piping such as aeration air piping, shall have exterior surfaces protected with a shop applied plastic coating. Coatings for hot piping shall be as specified.

Extra strong steel pipe in buried locations shall have exterior surfaces protected with a shop applied plastic coating. shall have exterior surfaces protected with a shop applied tape wrap. will have exterior surfaces protected with a field applied tape wrap as specified in the Miscellaneous Piping and Accessories Installation section.

All surfaces to be tape-wrapped in the shop shall be thoroughly cleaned and primed in accordance with the tape manufacturer's recommendations immediately before wrapping. The tape shall be applied by two-ply (half-lap) wrapping or as needed to provide a total installed tape thickness of at least 60 mils [1.5 mm].

Shop applied coatings shall be as follows:

External Coatings

Plastic	Liberty Coating Company "Pritec" or Bredero-Shaw "Entec". The products of other manufacturers will not be acceptable.
Tape Wrap	ANSI/AWWA C209, except single ply tape thickness shall not be less than 30 mils [760 µm]; Protecto Wrap "200" or Tapecoat "CT".
High temperature epoxy for	Shop or field applied high solids epoxy; suitable for protection at continuous pipe

aeration and process air piping wall temperatures up to 300 F. Coating shall be abrasion resistant. The finished coating shall have a minimum total film thickness of 10 mils. The surface shall be prepared in accordance with SSPC-SP7 as a minimum unless otherwise recommended by the coating manufacturer. The coating shall be Carboline "Thermaline 450", Ameron "Amerlock 400 with Amercoat 880 Additive", or approved equal.

PART 3 - EXECUTION

3-1. INSTALLATION. Materials furnished under this section will be installed in accordance with the Miscellaneous Piping and Accessories Installation section.

End of Section

THIS PAGE LEFT BLANK INTENTIONALLY

FIBERGLASS REINFORCED PLASTIC PIPE (AIR SERVICE)

PART 1 - GENERAL

1-1. SCOPE. This section covers furnishing low pressure fiberglass reinforced plastic pipe for application in exhaust air systems indicated on the drawings as odor control. Piping shall be furnished complete with all fittings, transitions, jointing materials, expansion joints, and other necessary appurtenances.

Pipe supports, anchors, and odor control dampers are covered in other sections.

1-2. GENERAL. Materials furnished and installed under this section shall be fabricated, assembled, erected, and placed in proper operating condition in full conformity with the drawings, specifications, engineering data, instructions, and recommendations of the manufacturer unless exceptions are noted by Engineer.

1-2.01. Coordination. Contractor shall verify that each component of the system furnished is compatible with all other parts of the system, that all piping and materials are appropriate for the expected services, and that all devices necessary for a properly functioning system have been provided.

1-2.02. Pipe Identification. Piping identification shall be as specified in the Protective Coating section.

1-3. SUBMITTALS.

1-3.01. Drawings and Data. Complete specifications, data and catalog cuts, and shop assembled layout drawings shall be submitted in accordance with the Submittals section. The data and specifications shall include, but shall not be limited to, the following:

Pipe

Manufacturer's name.

Brand designation.

Type of resin.

Pressure, vacuum, and temperature rating of pipe.

AWWA M-45 pipe stiffness calculation for buried pipe.

Certification of compliance with referenced standards.

Layouts and dimensions of subassemblies to be shipped.

Detailed instructions for field butt joints including lay-up sequence, width of each reinforcement layer, and total number of layers.

Where the pipe sizes needed for the project are larger than the named manufacturer's standard pipe sizes, the following information shall be submitted for the pipe and fittings that are being provided:

Manufacturer's name.

Certificate of compliance that states compliance with referenced construction standards and test methods.

- Material sources.
- Material types.
- Average reinforced wall thickness for each pipe size.
- Minimum reinforced wall thickness for each pipe size.
- Average outside diameter for each pipe size.
- Liner material.
- Nominal liner thickness for each pipe size.

Expansion Joints

- Name of manufacturer.
- Type and model.
- Materials of construction.
- Force required for expansion and contraction.

1-4. QUALITY ASSURANCE.

1-4.01. Manufacturer’s Field Services. The pipe manufacturer shall provide hands-on training for the installation contractor’s employees in the proper assembly of butt joints. The pipe manufacturer’s representative shall be on-site for at least one 8-hour day, during which they shall observe the assembly of at least three butt joints. The pipe manufacturer shall submit written certification that the installation contractor's employees have satisfactorily completed all training and instruction and can perform the jointing required for this project in accordance with the pipe manufacturer's recommendations and as specified herein. All field butt joints shall be made by representatives of the pipe manufacturer or by employees of the installation contractor who have been trained and certified by the pipe manufacturer. Qualified fitters shall carry and have visible at all times a certificate of qualification issued by the pipe manufacturer. Contractor shall arrange the qualifying training.

1.5. DELIVERY, STORAGE, AND HANDLING. Shipping shall be in accordance with the Shipping section. Handling and storage shall be in accordance with the Handling and Storage section. Pipe and fittings shall be properly supported to avoid damage caused by flexural strains. Pipe and fittings shall not be thrown or dropped.

PART 2 - PRODUCTS

2-1. SERVICE CONDITIONS. Fiberglass reinforced pipe will be used in odor control service condition(s).

2-2. DESIGN REQUIREMENTS.

2-2.01. Minimum Pipe Wall Stiffness. The minimum pipe wall stiffness, at 5 percent deflection, determined in accordance with ASTM D2412 and Section 3 of AWWA C950, shall be not less than the following:

<u>Nominal Pipe Diameter</u>		<u>Pipe Stiffness</u>	
<u>inches</u>	<u>[mm]</u>	<u>psi</u>	<u>[kPa]</u>
1-8	[25-200]	36	[250]

10	[250]	18	[125]
12-16	[300-400]	9	[62]
18 and larger, buried	[450 and larger, buried]	10 or greater as required	[70]
18 and larger, other locations	[450 and larger, other locations]	5	[35]

2-2.02. Temperature. All pipe, fittings, and appurtenances shall be suitable for the following temperature conditions.

Design maximum temperature	120 °F
Design minimum temperature.	0 °F

2-3. ACCEPTABLE MANUFACTURERS. The fiberglass reinforced plastic pipe, fittings and specials provided under this section shall be limited to the products of Ameron, Conley, or Smith/Fibercast as specified herein without exception.

2-4. MATERIALS.

The materials for the specified service conditions shall be as follows:

<u>Service Condition</u>	<u>Pipe Resin</u>
Odor Control, FA	Epoxy (20" and smaller)

Piping materials shall be as follows:

Epoxy Pipe

Centrifugally Cast

14 inches [350 mm] and smaller	ASTM D2997, RTRP-21C, centrifugally cast, reinforced epoxy resin pipe with 30 mil [750 µm] liner; Smith/Fibercast "Centricast RB-1520"; without exception.
--------------------------------------	--

Filament-Wound

16 inches [400 mm] and smaller	[ASTM D2996, RTRP-11FE-111, RTRP-11FF-312, and RTRP-11FQ-311, with at least a 20 mil [500 µm] reinforced liner; [Ameron "Bondstrand Series 2000; Conley "Schedule 20E"; Smith/Fibercast "Green Thread"; without exception.
--------------------------------------	--

18 through 20 inches [450 through 500 mm]	ASTM D2310, RTRP-11FQ, with at least a 20 mil [500 µm] reinforced liner; Conley "Schedule 20E" without exception.
---	---

Fittings	Manufacturer's standard, glass fiber reinforced, thickness to match pipe, compatible with the pipe and with chemical resistance equal to or greater than the pipe. Elbows 24 inch [600 mm] and smaller shall be smooth radius. Elbow 30 inch [750 mm] and larger shall be smooth radius or mitered. Mitered elbows shall be constructed of a least 4 sections and 3 mitered joints.
Flanges	ASTM D3982 made on the specified pipe.
Flange Bolts or Studs	ASTM F593, Type 304 stainless steel having a length such that, after installation, bolts will project 1/8 to 3/8 inch [3 to 9 mm] beyond the outer face of the nut.
Nuts	ASTM F594, Type 304 stainless steel.
Flat Washers	ANSI B18.22.1, Type 304 stainless steel.
Flange Gaskets	Full face, 1/8 inch [3 mm] thick, 40-50 durometer, EPDM.
Bell-and-Spigot Joints	Matched tapered bell-and-spigot ends bonded with adhesive.
Butt Joints	Butt and wrap, resin bonded using same resin as pipe, PS 15-69, with pressure rating equal to the pipe.
Expansion Joints	As specified herein.
Adhesive	Pipe manufacturer's standard.

All above grade pipe, fittings and appurtenances shall contain ultraviolet (UV) inhibitors.

Resins used in the piping system laminates, except for the inner corrosion liner, shall have a flame spread rating of 25 or less when tested in accordance with ASTM E84. The manufacturer's products named shall be used with a fire retardant resin substitution that is certified to meet or exceed ASTM requirements by the manufacturer.

2-5. FABRICATION.

2-5.01. Jointing Method. Unless otherwise specified, 14 inch [350 mm] and smaller pipe shall have adhesive bonded joints. Sixteen inch [400 mm] and larger pipe shall have adhesive bonded butt joints. Shop fabricated assemblies should be provided to the maximum extent possible, to minimize the number of field joints. Shop fabrications including fittings and specials must be constructed by the pipe manufacturer or pipe manufacturer's certified pipe fabrication source.

Flanged joints shall be provided at each damper and item of equipment to facilitate disassembly, at each change in material, and where indicated on the drawings. Bolts, nuts, washers, and gaskets shall be provided for all flanged connections in the piping system, including connections to equipment.

Field butt joints shall be located at least 12 inches [300 mm] from any increasing or decreasing cross-section of pipe where the pipe to be jointed has the same diameter.

2-5.02. Transitions. Fiberglass reinforced plastic transition sections shall be furnished for connecting round pipe to rectangular openings on equipment. Transitions shall have a pressure rating and wall stiffness equal to those of the pipe. Internal lining shall be of the same type of material and thickness as specified for the pipe. Transitions shall have flanged end connections compatible with the connecting pipe and equipment.

2-5.03. Expansion Joints. Expansion joints shall be furnished at the locations indicated on the drawings and at other locations required for proper pipe installation. Expansion joints shall be resistant to ultraviolet light and shall be suitable for the service conditions.

Expansion joints shall be fully molded type rated for a minimum 3 psi [21 kPa] working pressure and shall consist of an inner tube, body, and outer cover to be compatible with the specified service conditions. The tube shall be a minimum of 1/4 inch [6 mm] thick EPDM with two ply of high tensile nylon, polyester, or kevlar fabric reinforcement. The cover shall be a minimum 1/16-inch [1.5 mm] elastomer and shall be resistant to ultraviolet light.

Slip on type expansion joints shall fit tightly on the outside diameter of the piping and shall be secured in place by stainless steel adjustable bands with worm screw type adjustments to provide a gastight connection.

Flanged type expansion joints shall have split stainless steel retaining rings and shall have ASTM D3982 diameter and drilling. Expansion joints shall be Red Valve "Duct Expansion Joints", Mercer Rubber Company, or Holz Rubber Company.

PART 3 - EXECUTION

3-1. INSPECTION. Pipe and fittings shall be carefully examined for cracks and other defects immediately before installation. Any pipe that is damaged or shows evidence of contamination shall not be installed in the piping system.

3-2. PREPARATION.

3-2.01. Field Measurement. Pipe shall be cut to measurements taken at the site, not from the drawings. All necessary provisions shall be made in laying out piping to allow for expansion and contraction. Piping shall not obstruct openings or passageways. Pipe shall be held free of contact with building construction to avoid transmission of noise resulting of expansion.

3-3. INSTALLATION. Pipe shall be installed as specified and as indicated on the drawings. All necessary provisions shall be taken in the fabrication and installation of piping to provide for expansion and contraction. Expansion joints shall be installed as specified in the Pipe Supports section.

The piping shall be supported as indicated on the drawings and in accordance with the requirements of the Pipe Supports section. The inside of pipe, fittings, and transitions shall be smooth, clean and free from blisters, when installed.

3-3.01. Pipe Sleeves. Piping passing through concrete or masonry shall be installed through sleeves installed before the concrete is placed or when masonry is laid.

3-3.02. Pipe Joints. Pipe joints shall be carefully and neatly made in accordance with the following specified requirements. All field joints made by trained and certified employees that are not representatives of the pipe manufacturer shall be made using individually packaged joint kits.

3-3.02.01. Adhesive Bonded Joints. All joint preparation, cutting, and jointing for adhesive bonded joints shall comply with the pipe manufacturer's recommendations. Adhesive shall be mixed and applied in accordance with the manufacturer's recommendations. Newly assembled joints shall be suitably blocked or restrained to prevent movement during the recommended curing period.

3-3.02.02. Flanged Joints. Flange bolts shall be tightened sufficiently to slightly compress the gasket and make a good seal, but not so tight as to distort the flanges. A flat washer shall be installed under each nut and bolt head.

3-3.02.03. Butt Joints. Butt joints shall be made in accordance with the manufacturer's recommendations and as specified herein. Twenty inch [500 mm] and larger pipe shall be overlaid both inside (when accessible) and outside. Eighteen inch [450 mm] and smaller pipe shall be overlaid on the outside only. The minimum width of the overlay shall be as specified in the following table. Inside overlaps shall be made to seal the joint but shall not be considered in meeting the strength requirements.

<u>Pipe Size</u>		<u>Minimum Total Width of Overlay</u>	
inches	[mm]	inches	[mm]
18-20	[450-500]	14	[350]
24-36	[600-900]	18	[450]
42-54	[1050-1350]	24	[600]
60-72	[1500-1825]	26	[650]

Finished joints shall be built up in successive layers, shall be as strong as the pieces being joined, and shall be as crevice-free as is commercially practicable, in accordance with ASTM D2563. The width of the first layer shall be at least 4 inches [100 mm]. Successive layers shall be increased uniformly to provide the specified minimum total width of overlay which shall be centered on the joint. Crevices between jointed pieces shall be filled with resin, leaving a smooth inner surface. The interior of joints shall also be sealed by covering with not less than 0.1 inch [2 mm] of liner of the same material as the pipe.

The inner surface shall be free of cracks and crazing, with a smooth finish, and with an average of not more than two pits per square foot [21 pits per square meter], provided the pits are less

than 1/8 inch [3 mm] in diameter, not more than 1/32 inch [0.7 mm] deep, and covered with sufficient resin to avoid exposure of inner surface fabric. Some waviness is permissible as long as the surface is smooth and free of pits. Such surfaces may be reinforced with glass surfacing mat, synthetic fibers, or other suitable material.

3-3.03. Alignment. Piping installed below grade shall be laid to the lines and grades indicated on the drawings. Batter boards, laser beam equipment, or surveying instruments shall be used to maintain alignment and grade.

Batter boards, if used, shall be erected at intervals of not more than 25 feet [7 m]. Batter boards shall be used to determine and check pipe subgrades. At least three batter boards shall be maintained in proper position at all times when trench grading is in progress.

If laser beam equipment is used, periodic elevation measurements shall be made with surveying instruments to verify accuracy of grades. If such measurements indicate thermal deflection of the laser beam due to differences between the ground temperature and the air temperature within the pipe, precautions shall be taken to prevent or minimize further thermal deflections.

3-3.04. Laying Pipe. Pipe installed below grade shall be protected from lateral displacement by placing the specified pipe embedment material. Pipe shall not be laid in water or under unsuitable weather or trench conditions.

Pipe laying shall begin at the lowest elevation with bell ends facing the direction of laying, except when reverse laying is permitted by Engineer.

Whenever pipe laying is stopped, the open end of the pipe shall be closed with an end board closely fitting the end of the pipe, to keep sand and earth out of the pipe. The end board shall have several small holes near the center to permit water to enter the pipe and to prevent flotation in the event of flooding of the trench.

3-4. FIELD QUALITY CONTROL.

3-4.01. Field Testing. All joints in piping shall be tight and free of leaks. All joints which are found to leak, by observation or during any specified test, shall be repaired, and the tests repeated. All necessary testing equipment and materials, including tools, appliances, and devices, shall be furnished by Contractor. All tests shall be made by and at the expense of Contractor and at such time as directed by Engineer. All tests shall be conducted in a manner acceptable to Engineer and shall be repeated as many times as necessary to demonstrate compliance with specified requirements. Engineer shall be present during all testing.

Leakage may be determined by loss-of-pressure, soap solution, or positive and accurate method acceptable to Engineer. All equipment or other accessories which would be damaged if subjected to the specified test pressure shall be disconnected, and ends of branch lines plugged or capped, as required, during the testing procedures.

End of Section

This page was left blank intentionally

Section 15067

MISCELLANEOUS PLASTIC PIPE, TUBING, AND ACCESSORIES

PART 1 - GENERAL

1-1. SCOPE. This section covers the furnishing of miscellaneous plastic pipe, tubing, and accessories. Pipe and tubing shall be furnished complete with all fittings, flanges, unions, jointing materials and other necessary appurtenances.

1-2. SUBMITTALS.

1-2.01. Drawings and Data. Complete specifications, data and catalog cuts or drawings shall be submitted in accordance with the submittals section. Submittals are required for all piping, fittings, gaskets, sleeves, and accessories, and shall include the following data:

Name of Manufacturer
Type and model
Construction materials, thickness, and finishes
Pressure and temperature ratings

Contractor shall obtain and submit a written statement from the gasket material manufacturer certifying that the gasket materials are compatible with the joints specified herein and are recommended for the specified field test pressures and service conditions.

1-3. DELIVERY, STORAGE, AND HANDLING. Shipping shall be in accordance with the Shipping section. Handling and storage shall be in accordance with the Handling and Storage section. All materials shall be stored in a sheltered location above the ground, separated by type, and shall be supported to prevent sagging or bending.

Pipe, tubing, and fittings shall be stored between 40°F and 90°F.

PART 2 - PRODUCTS

2-1. FRP PIPE. Not used.

2-2. PVC PIPE MATERIALS. PVC pipe materials and services shall be as specified herein.

2-2.01. Material Classification PVC-1.

PVC-1 – Schedule 40 PVC Pipe with Solvent Welded Joints. Condensate drain piping.	Pipe	ASTM D1785, Cell Classification 12454, bearing NSF seal, Schedule 40.
	Fittings	ASTM D2466, Cell Classification 12454, bearing NSF seal.

2-2.02. Material Classification PVC-2.

PVC-2 – Schedule 80 PVC Pipe with Solvent Welded Joints. Potable water service piping. Odor control drain piping. Air release valve discharge piping.	Pipe	ASTM D1785, Cell Classification 12454, bearing NSF seal, Schedule 80.
	Fittings	ASTM D2467, Cell Classification 12454, bearing NSF seal. Flanges or unions shall be provided where needed to facilitate disassembly of equipment or valves. Flanges or unions shall be joined to the pipe by a solvent weld.

2-2.03. Material Classification PVC-3. Not used.

2-2.04. Material Classification PVC-4. Not used.

2-2.05. Material Classification PVC-5. Not used.

2-2.06. Material Classification PVC-6. Not used.

2-2.07. Material Classification PVC-7. Not used.

2-2.08. Material Classification PVC-8. Not used.

2-2.09. Accessory Materials. Accessory materials for the PVC Pipe systems shall be as indicated.

Flanges

Diameter and drilling shall conform to
ANSI/ASME B16.5, Class 150.

Schedule 80 for DWV systems.

Flange Bolts and Nuts	ASTM A307, Grade B, length such that, after installation, the bolts will project 1/8 to 3/8 inch [3 to 10 mm] beyond outer face of the nut. Stainless steel for DWV and chemical feed systems, galvanized steel for all other systems.
Flat Washers	ANSI B18.22.1, plain. Same material as bolts and nuts.
Flange Gaskets	Full face, 1/8 inch [3 mm] thick, chemical-resistant elastomeric material suitable for the specified service.
Expansion Joints	Edlon "Thermo-molded TFE" or Resistoflex "Style R6905" molded expansion joint.

2-3. PE PIPE. PE pipe materials and services shall be as specified herein.

2-3.01. Material Classification PE-1. Not used.

2-3.02. Material Classification PE-2. Not used.

2-3.03. Material Classification PE-3. Not used.

2-3.04. Material Classification PE-4.

PE-4 – Polyethylene Pipe. 2” HDD pipe under road.	Pipe	ASTM D3350, Cell Classification PE345464C or PE345464E. ASTM F412, SDR-11, pressure rating Driscoplex "PE 3408".
	Fittings	Molded or manufactured from pipe; cell classification of material and pressure rating same as for pipe.

2-3.05. Material Classification PE-5. Not used.

2-3.06. Material Classification PE-6. Not used.

2-3.07. Accessory Materials. Accessory materials for the PE Pipe systems shall be as indicated.

Flanges	Schedule 80 PVC; diameter and drilling shall conform to ANSI/ASME B16.5, Class 150.
Flange Bolts and Nuts	ANSI B18.2.1, ASTM A193, AISI Type 304,

heavy hex head, length such that after installation the bolts will project 1/8 to 3/8 inch [3 to 10 mm] beyond outer face of the nut. ASTM A194, AISI Type, ANSI/ASME B18.2.2, heavy hex pattern.

Fittings and Flange Adapters

Molded or manufactured from the pipe; cell classification of material and pressure rating same as for pipe.

PART 3 - EXECUTION

3-1. INSTALLATION. Materials furnished under this section will be installed in accordance with the Miscellaneous Piping and Accessories Installation section.

End of Section

MISCELLANEOUS BALL VALVES

PART 1 - GENERAL

1-1. SCOPE. This section covers the furnishing of manually operated or remote activated two position (open-close) ball valves as specified herein.

Miscellaneous ball valves shall be provided where AWWA type ball valves are not required.

Piping, pipe supports, insulation, and accessories that are not an integral part of the valves or are not specified herein are covered in other sections.

1-2. GENERAL.

1-2.01. General Equipment Stipulations. The General Equipment Stipulations shall apply to all equipment and materials furnished under this section. If the requirements in this section are different from those in the General Equipment Stipulations, the requirements in the section shall take precedence.

1-2.02. Permanent Number Plates. Not used.

1-3. SUBMITTALS. Complete drawings, details, and specifications covering the valves and their appurtenances shall be submitted in accordance with the Submittals section. Included in the submittal shall be drawings by the valve manufacturer to indicate the position of the valve actuator and valve shaft.

1-4. DELIVERY, STORAGE, AND HANDLING. Shipping shall be in accordance with the Shipping section. Handling and storage shall be in accordance with the Handling and Storage section.

PART 2 - PRODUCTS

2-1. CONSTRUCTION. Ball valves shown on the drawing, but not specified herein, shall be selected to match piping material they are installed in.

2-1.01. Valves Type VB-1.

VB-1	Rating	500 psi [3.4 MPa] nonshock cold WOG
Supply Water Service.	Code Type	MSS SP-110 In-line, two piece, end entry, full port
2 inch and	Body/Bonnet	ASTM B584-C84400 bronze

smaller	Trim	Reinforced Teflon
	Seat	Brass, or chrome plated brass
	Ball	Brass or bronze
	Stem	Reinforced Teflon
	Thrust Washer	Teflon or Viton
	Stem Seal	Threaded End
	End Connection	-20 to 400°F [-29 to 204°C]
	Temp. Limitations	Lever
	Valve Operator	Conbraco Industries "Apollo 77-100 Series"; Powell "Fig 4210T"
	Manufacturers	

2-1.02. Valves Type VB-2.

VB-2	Rating	500 psi [3.4 MPa] nonshock cold WOG
Supply Water Service.	Code	MSS SP-110
	Type	In-line, three piece, end entry, full port
2-1/2 inch and 3 inch	Body/Bonnet	ASTM B584-C84400 Bronze
	Trim	
	Seat	Reinforced Teflon
	Ball	Brass or chrome plated
	Stem	Brass or Bronze
	Thrust Washer	Reinforced Teflon
	Stem Seal	Teflon or Viton
	End Connection	Threaded End
	Temp. Limitations	-20 to 400°F [-29 to 204°C]
	Valve Operator	Lever
	Manufacturers	Conbraco Industries "Apollo 82-100 Series"

2-1.03. Valves Type VB-3. Not used.

2-1.04. Valves Type VB-4. Not used.

2-1.05. Valves Type VB-5. Not used.

2-1.06. Valves Type VB-6. Not used.

2-1.07. Valves Type VB-7. Not used.

2-1.08. Valves Type VB-8. Not used.

2-1.09. Valves Type VB-9. Not used.

2-1.10. Valves Type VB-10. Not used.

2-1.11. Valves Type VB-11. Not used.

2-1.12. Valves Type VB-12. Not used.

2-1.13. Valves Type VB-13. Not used.

2-1.14. Valves Type VB-14. Not used.

2-1.15. Valves Type VB-15. Not used.

2-1.16. Valves Type VB-16. Not used.

2-1.17. Valves Type VB-17. Not used.

2-1.18. Length Tolerance. Unless otherwise specified, the actual length of valves shall be within plus or minus 1/16 inch [1.6 mm] of the specified or theoretical length.

2-1.19. Shop Coatings. All ferrous metal surfaces of valves and accessories, both interior and exterior, shall be shop coated for corrosion protection. The valve manufacturer's standard coating will be acceptable, provided it is functionally equivalent to the specified coating.

Coating Materials

Asphalt Varnish

Fed Spec TT-C-494.

Coal Tar Epoxy

High-build coal tar epoxy; Ameron "Amercoat 78HB Coal Tar Epoxy", Carboline "Bitumastic 300 M", Tnemec "46H-413 Hi-Build Tneme-Tar", or Sherwin-Williams "Hi-Mil Sher-Tar Epoxy".

Epoxy Enamel (for liquid service)

Ameron "Amerlock 400 High-Solids Epoxy Coating", Carboline "Carboguard 891", or Tnemec "Series N140 Pota-Pox Plus".

Rust-Preventive Compound

As recommended by the manufacturer.

Surfaces To Be Coated

Unfinished Surfaces

Interior Surfaces

Liquid Service

Asphalt varnish (two coats) or epoxy enamel.

Exterior Surfaces of Valves To Be Buried, Submerged, or Installed in Manholes or Valve Vaults

Asphalt varnish or coal tar epoxy.

Exterior Surfaces of all other valves

Universal primer.

2-2. VALVE ACTUATORS. Ball valve, except those which are equipped with power actuators or are designed for automatic operation, shall be provided with manual actuators. Unless otherwise specified or indicated on the drawings, each manual actuator shall be equipped with a lever operator. Ball valves with center lines more than 7'-6" [2.3m] above the floor shall be provided with chain levers.

Valves indicated to be electric motor operated on the drawings shall have reversible electric motor operators designed for 120 volt ac, single phase operation. Actuators shall include integral thermal overload protection and a declutchable manual override. Actuators shall be equipped with motor operation limit switches and two additional single-pole, double-throw limit switches for auxiliary open and closed indication. An internal heater and thermostat shall be provided in each actuator housing to prevent condensation. Actuators in Class I, Division 1 and Division 2, Group D hazardous areas indicated on the drawings shall have NEMA Type 7 housings. Actuators in other areas shall have NEMA Type 4X housings.

2-3. ACCESSORIES. If the drawings indicate the need for extension stems, stem guides; position indicator; floor boxes; valve boxes; or operating stands, refer to the Valve and Gate Actuator section.

PART 3 - EXECUTION

3-1. INSTALLATION. Materials furnished under this section shall be installed in accordance with the Valve Installation section.

End of Section

CHECK VALVES

PART 1 - GENERAL

1-1. SCOPE. This section covers the furnishing of check valves as specified herein and as indicated in the Check Valve Schedule.

Piping, pipe supports, insulation, and accessories that are not an integral part of the valves or are not specified herein are covered in other sections.

1-2. GENERAL. Equipment furnished under this section shall be fabricated and assembled in full conformity with drawings, specifications, engineering data, instructions, and recommendations of the equipment manufacturer unless exceptions are noted by Engineer.

Valves shall be furnished with all necessary parts and accessories indicated on the drawings, specified, otherwise required for a complete, properly operating installation and shall be the latest standard products of a manufacturer regularly engaged in the production of valves.

1-2.01. General Equipment Stipulations. The General Equipment Stipulations shall apply to all equipment furnished under this section. If requirements in this specification differ from those in the General Equipment Stipulations, the requirements specified herein shall take precedence.

1-2.02. Temporary Number Plates. Not used.

1-2.03. Permanent Number Plates. All check valves, except buried or submerged valves, that have been assigned a number on the drawings or in the Check Valve Schedule, shall be provided with a permanent number plate. The location of number plates and the method of fastening shall be acceptable to Engineer. Numerals shall be at least 1 inch [25 mm] high and shall be black baked enamel on anodized aluminum plate.

1-3. SUBMITTALS. Complete drawings, details, and specifications covering the valves and their appurtenances shall be submitted in accordance with the Submittals section. Included in the submittal shall be drawings by the valve manufacturer to indicate the position of the valve actuator and valve shaft.

1-4. DELIVERY, STORAGE, AND HANDLING. Shipping shall be in accordance with the Shipping section. Handling and storage shall be in accordance with the Handling and Storage section.

PART 2 - PRODUCTS

2-1. CONSTRUCTION.

2-1.01. Valves VC-1. Not used.

2-1.02. Valves VC-2. Not used.

2-1.03. Valves VC-3. Not used.

2-1.04. Valves VC-4. Not used.

2-1.05. Valves VC-5. Not used.

2-1.06. Valves VC-6. Not used.

2-1.07. Valves VC-7. Not used.

2-1.08. Valves VC-8. Not used.

2-1.09. Valves VC-9. Not used.

2-1.10. Valves VC-10.

VC -10	Rating	Class 125
Wastewater pump discharge service	Code	AWWA C508
6 inch [150 mm] and larger pipe	Type	Horizontal swing, bolted bonnet
	Body	ASTM A126 Class B cast iron
	Trim	
	Seat Ring	ASTM B763 Alloy 84400 bronze
	Disc	ASTM A126 Class B cast iron
	Hinge Pins	Stainless steel
	Bearings	Bronze bushings
	Cover Gasket	Manufacturer's standard
	End Connection	Flanged, ASME B16.1, Class 125, flat faced
	Temp. Limitations	-20 to 212°F [-29 to 100°C]
	Valve Operator	Weighted lever
	Manufacturers	American Flow Control "50 SC", M&H "Style 159", Mueller "A2600-6-01"

2-1.11. Valves VC-11. Not used.

2-1.12. Valves VC-12. Not used.

2-1.13. Valves VC-13. Not used.

2-1.14. Valves VC-14. Not used.

2-1.15. Valves VC-15. Not used.

2-1.16. Valves VC-16. Not used.

2-1.17. Valves VC-17. Not used.

2-1.18. Valves VC-18. Not used.

2-1.19. Valves VC-19. Not used.

2-1.20. Shop Coatings. All ferrous metal surfaces of valves and accessories, both interior and exterior, shall be shop coated for corrosion protection. The valve manufacturer's standard coating will be acceptable, provided it is functionally equivalent to the specified coating.

Coating Materials

Asphalt Varnish	Fed Spec TT-C-494.
Coal Tar Epoxy	High-build coal tar epoxy; Ameron "Amercoat 78HB Coal Tar Epoxy", Carboline "Bitumastic 300 M", Tnemec "46H-413 Hi-Build Tneme-Tar", or Sherwin-Williams "Hi-Mil Sher-Tar Epoxy".
Epoxy Enamel (for liquid service)	Ameron "Amerlock 400 High-Solids Epoxy Coating", Carboline "Carboguard°891", or Tnemec "Series N140 Pota-Pox Plus".
Rust-Preventive Compound	As recommended by the manufacturer.

Surfaces To Be Coated

Unfinished Surfaces

Interior Surfaces

Liquid Service	Epoxy enamel.
----------------	---------------

Exterior Surfaces of Valves To Be Buried, Submerged, or Installed in Manholes or Valve Vaults	Asphalt varnish or coal tar epoxy.
---	------------------------------------

Exterior Surfaces of All Other Valves	Universal primer.
---------------------------------------	-------------------

Polished or Machined Surfaces	Rust-preventive compound.
-------------------------------	---------------------------

Actuators and Accessories

Universal primer.

PART 3 - EXECUTION

3-1. INSTALLATION. Materials furnished under this section will be installed in accordance with Valve Installation section.

End of Section

Schedule 15093-S01
Check Valves Schedule

1.010	1.020	1.030	1.040	1.050	1.060
Tag Number	Size	Type of Valve	Service	Design Capacity	Ends(1)
1	2	3	4	5	6
	(in)			(gpm)	
VCK-3151-01	12	VC-10	WW Pump Discharge	1000	F
VCK-3151-02	12	VC-10	WW Pump Discharge	1000	F
VCK-3151-03	12	VC-10	WW Pump Discharge	1000	F
VCK-3151-04	12	VC-10	WW Pump Discharge	1000	F
VCK-3151-05	12	VC-10	WW Pump Discharge	1000	F
VCK-3151-06	12	VC-10	WW Pump Discharge	1000	F

Notes:

(1) Abbreviations for valve ends are as indicated:

F	Flanged
MJ	Mechanical joint
P	Push-on joint

END OF SCHEDULE

BACKFLOW PREVENTERS

PART 1 - GENERAL

1-1. SCOPE. This section covers the furnishing of backflow preventers and associated appurtenances, as indicated herein.

Piping, pipe supports, insulation, and accessories which are not an integral part of the backflow preventers or are not specified herein are covered in other sections.

1-2. GENERAL.

1-2.01. General Equipment Stipulations. The General Equipment Stipulations shall apply to all equipment and materials provided under this section. If requirements in this specification differ from those in the General Equipment Stipulations, the requirements specified herein shall take precedence.

1-2.02. Permanent Number Plates. All backflow preventers that have been assigned a number on the drawings or in the Backflow Preventer Schedule, shall be provided with a permanent number plate. The location of number plates and the method of fastening shall be acceptable to Engineer. Numerals shall be at least 1 inch [25 mm] high and shall be black baked enamel on anodized aluminum plate.

1-3. SUBMITTALS.

1-3.01. Drawings and Data. Complete fabrication and assembly drawings, together with detailed specifications and data covering materials, parts, devices, and accessories forming a part of the equipment furnished, shall be submitted in accordance with the submittals section. The data and specifications for each unit shall include, but shall not be limited to the following:

- Name of manufacturer.
- Type and model.
- Construction materials and finishes.
- Net weight.
- Unit dimensions.
- Performance curves indicating flow capacity versus pressure drop.

1-3.02. Operations and Maintenance Data and Manuals. Adequate operation and maintenance information shall be supplied as required in the Submittals section. Operation and maintenance manuals shall be submitted in accordance with the Submittals section. The operation and maintenance manuals shall be in addition to any instructions or parts lists packed with or attached to the equipment when delivered.

1-4. DELIVERY, STORAGE, AND HANDLING. Shipping shall be in accordance with the Shipping section. Handling and Storage shall be in accordance with the handling and storage section.

PART 2 - PRODUCTS

2-1. PERFORMANCE AND DESIGN REQUIREMENTS. Backflow preventers shall be designed to meet the requirements as indicated herein.

2-2. ACCEPTABLE MANUFACTURERS. Acceptable manufacturers and specific products are listed in the Design and Construction paragraph.

2-3. DESIGN AND CONSTRUCTION. Backflow prevention device type shall be as indicated herein.

2-3.01. Reduced Pressure Zone Backflow Preventers. Reduced pressure zone (RPZ) backflow preventers shall consist of isolation valves, two independent check valves, and differential relief valve. The assembly shall automatically reduce the pressure in the zone between the check valves. In the event that the reduced pressure is not maintained, the differential relief valve shall open, maintaining the proper zone differential. RPZ backflow preventers shall comply with AWWA C511-92 and ASSE Standard 1013 requirements and shall be suitable for horizontal installation. Each RPZ backflow preventer shall be provided with a relief valve air-gap drain fitting.

RPZ backflow preventers in 2 inch [50 mm] and smaller sizes shall be provided with bronze bodies and with a threaded bronze bodied ball valve on each end of the device. Two inch [50 mm] and smaller RPZ backflow preventers shall be Febco "Model 860", Wilkens "Model 975XL", or Watts Regulator "Series 909".

2-3.01.01 Strainers. Strainers shall be provided where indicated on the drawings. Strainer screen size shall be 20 mesh unless otherwise indicated. The blowoff from each strainer shall be equipped with a shutoff valve.

Strainers located in ductile iron piping systems shall be Y-pattern type with iron body, flanged ends, and monel or stainless steel screens. Strainers shall be Hoffman ITT "Series 400" or Metraflex "Model TF".

PART 3 - EXECUTION

3-1. INSTALLATION. Materials furnished under this section will be installed in accordance with Section 15010.

End of Section

Backflow Preventer Schedule

Device Number	Location	Size (in)	Max Flow (gpm)	Max Pressure Drop (psi)	Type (1)
BFP-3151	PS 3151 yard	2	50	13	RPZ

Notes:

(1) Abbreviations for backflow preventer type:

RPZ Reduced Pressure Zone

This page was left blank intentionally

Section 15102

ECCENTRIC PLUG VALVES

PART 1 - GENERAL

1-1. SCOPE. This section covers furnishing all eccentric plug valves as required by the Work and as indicated in the Eccentric Plug Valve Schedule. Plug valves shall be furnished complete with actuators and accessories as specified herein, as indicated in the schedule, and as specified in the Valve and Gate Actuators section.

1-2. GENERAL. Equipment provided under this section shall be fabricated and assembled in full conformity with drawings, specifications, engineering data, instructions, and recommendations of the equipment manufacturer, unless exceptions are noted by Engineer.

Valves shall be furnished with all necessary parts and accessories indicated on the drawings, specified, or otherwise required for a complete, properly operating installation and shall be the latest standard products of a manufacturer regularly engaged in the production of valves.

1-2.01. General Equipment Stipulations. The General Equipment Stipulations shall apply to all equipment and materials furnished under this section. If the requirements in this section are different from those in the General Equipment Stipulations, the requirements in the section shall take precedence.

1-2.02. Governing Standard. Except as modified or supplemented herein, all eccentric plug valves and manual actuators shall conform to the applicable requirements of ANSI/AWWA C517.

1-2.03. Marking. Each valve shall be marked with the manufacturer's name, valve size, and pressure rating, and the country of origin of the body casting. All markings shall be cast on the exterior surface of the valve body. An identifying serial number shall be stamped on a corrosion-resistant plate attached to the valve body.

1-2.04. Temporary Number Plates. Not used.

1-2.05. Permanent Number Plates. All plug valves, except buried or submerged valves, that have been assigned a number on the drawings or in the Eccentric Plug Valve Schedule, shall be provided with a permanent number plate. The location of number plates and the method of fastening shall be acceptable to Engineer. Numerals shall be at least 1 inch [25 mm] high and shall be black baked enamel on anodized aluminum plate.

1-3. SUBMITTALS. Complete drawings, details, and specifications covering the valves and their appurtenances shall be submitted in accordance with the Submittals section.

Certified copies of reports covering proof-of-design testing of valves as set forth in Section 5. of ANSI/AWWA C517, with an affidavit of compliance as indicated in Section 6.3 of C517, shall be submitted to Engineer before the valves are shipped.

1-4. DELIVERY, STORAGE, AND HANDLING. Shipping shall be in accordance with the Shipping section. Handling and storage shall be in accordance with the Handling and Storage section.

PART 2 - PRODUCTS

2-1. ACCEPTABLE PRODUCTS. Eccentric plug valves furnished under this section shall be manufactured by DeZurik, Pratt, Milliken, Val-Matic or Clow, without exception.

2-2. MATERIALS. Materials used in the manufacture of eccentric plug valves shall be as indicated:

Body	Cast iron, ASTM A126, Class B; or ductile iron, ASTM A536, Grade 65-45-12.
Plug	Cast iron, ASTM A126, Class B; or ductile iron, ASTM A536, Grade 65-45-12.
Plug Facing	Chloroprene, Neoprene or Buna-N, 70 Type A durometer hardness in accordance with ASTM D2240.
Body Seat	Welded nickel overlay.
Upper and Lower Trunnion Bearings	Sleeve type; stainless steel or bronze.
Upper Thrust Bearing	TFE, Nylatron, or Delrin.
Stem Seal	V-type packing or U-cups, Buna-N or TFE.

The following are acceptable shop coatings.

Coal Tar Epoxy	High-build coal tar epoxy; Ameron "Amercoat 78HB Coal Tar Epoxy", Carboline "Bitumastic 300 M", Tnemec "46H-413 Hi-Build Tneme-Tar", or Sherwin-Williams "Hi-Mil Sher-Tar Epoxy".
Epoxy	
For Gas Service	Ameron "Amercoat 385 Epoxy", Carboline "Carboguard 890", Tnemec "Series N69 Hi-Build Epoxoline II", or Plasite "Plasguard 7122".
For Liquid Service other than in potable water facilities	Ameron "Amercoat 385 Epoxy", Carboline "Carboguard 890", or Tnemec "Series N69 Hi-Build Epoxoline II".

For Raw or Treated Water Service
in potable water facilities (NSF
certified)

Ameron "Amercoat 400 High Solids
Epoxy", Carboline "Carboguard 891",
or Tnemec "Series N140 Pota-Pox
Plus".

2-3. VALVE CONSTRUCTION.

2-3.01. Valve Body. The valve port area of each valve shall be at least 80 percent of the cross section of the connecting piping for 20 inch [500 mm] and smaller valves and 70 percent for 24 inch [600 mm] and larger valves. Valves shall provide tight shutoff at the rated pressure from either direction. An adjustable closed position plug stop shall be provided.

Each valve body shall be plainly marked to indicate the seat end. The actual length of 10 inch [250 mm] and smaller valves shall be within plus or minus 1/16 inch [1.6 mm] of the theoretical length. The actual length of 12 inch [300 mm] and larger valves shall be within plus or minus 1/8 inch [3 mm] of the theoretical length.

Valve ends shall be compatible with connecting piping. All valves shall have flanged, grooved or mechanical joint ends as indicated in the Eccentric Plug Valve Schedule. Flange diameter and drilling shall conform to ANSI B16.1, Class 125. Flanges shall be flat faced and finished to true plane surfaces within a tolerance limit of 0.005 inch [0.12 mm]. The finished face shall be normal to the longitudinal valve axis within a maximum angular variation tolerance of 0.002 inch per foot [0.16 mm per meter] of flange diameter. Grooved end dimensions shall conform to AWWA C606, Table 5, for rigid joints. When grooved end valves are to be installed in flanged piping, two flange adapters compatible with the connecting piping shall be provided with each valve. Mechanical joint ends shall conform to ANSI/AWWA C111/A21.11.

Valve bodies shall be rated for a working pressure as indicated on the Eccentric Plug Valve Schedule.

2-3.02. Plug. The plug shall be of one-piece construction and shall have a cylindrical or spherical seating surface eccentrically offset from the center of the plug shaft. The interference between the plug face and the body seat, with the plug in the closed position, shall be externally adjustable in the field with the valve in the line under pressure. Plug surfaces shall be faced with a resilient material.

2-3.03. Seats. Seats shall be cast in the body and shall have raised, welded-in nickel overlay not less than 0.050 inch [1.30 mm] thick on all surfaces in contact with the plug face. The overlay shall be at least 90 percent nickel and have a Brinell hardness of 200 or greater.

2-3.04. Stem Seals. The valve shaft shall be sealed by U-cups or by at least four self-adjusting chevron type packing rings.

2-4. VALVE ACTUATORS. Requirements for valve actuators shall be as specified herein and as specified in the Valve and Gate Actuators section. Valve actuators shall be manual.

Geared actuators shall be used for manually operated valves in the following applications:

floor boxes, operating stands, and valve boxes shall be as indicated in the Eccentric Plug Valve Schedule as indicated on the drawings and as specified in the Valve and Gate Actuators section.

2-7. TESTING. Except as modified herein, eccentric plug valves shall be tested in accordance with Section 5 of ANSI/AWWA C517. Each valve shall be performance tested in accordance with Section 5.2. The leakage test shall be applied to the seating face of the plug (tending to unseat the plug) at the rated pressure of the valve.

Each valve shall be leaktight in both directions when closed by the actuator with the maximum differential pressure applied to the plug as specified in the Eccentric Plug Valve Schedule.

PART 3 - EXECUTION

3-1. INSTALLATION. Valves will be installed in accordance with Valve Installation section.

3-1.01. Installation Check. An installation check by an authorize representative of the manufacturer is not required.

End of Section

This page was left blank intentionally

**Schedule 15102-S01
Eccentric Plug Valves Schedule
Manual Actuators**

1.010	1.020	1.030	1.040	1.050	1.060	1.080	1.090	2.010	2.020	8.010	8.020	8.040	8.041
Tag Number	Size	Rated Working Pressure	Type of Service(1)	Type of Installation(2)	Ends(3)	Maximum Differential Pressure Across Valve	High Pressure Side of Plug(5)	Type of Manual Actuator(4)	Limit Switches(6)	Extensions Stems	Position Indicator for Buried Valve Actuators	Cast Iron Operating Stands	Fabricated Steel Operating Stands
	(in)	(psi)				(psi)							
VPG-3151-01	12	150	OC	AG	F	40	U	HW	No	No	N/A	No	No
VPG-3151-02	12	150	OC	AG	F	40	U	HW	No	No	N/A	No	No
VPG-3151-03	12	150	OC	AG	F	40	U	HW	No	No	N/A	No	No
VPG-3151-04	12	150	OC	AG	F	40	U	HW	No	No	N/A	No	No
VPG-3151-05	12	150	OC	AG	F	40	U	HW	No	No	N/A	No	No
VPG-3151-06	12	150	OC	AG	F	40	U	HW	No	No	N/A	No	No
VPG-3151-07	16	150	OC	AG	F	40	U	HW	No	No	N/A	No	No
VPG-3151-08	16	150	OC	AG	F	40	U	HW	No	No	N/A	No	No
VPG-3151-09	20	150	OC	AG	F	40	U	HW	No	No	N/A	No	No
VPG-3151-10	8	150	OC	AG	F	40	U	HW	No	No	N/A	No	No
VPG-3151-11	20	150	OC	B4	MJ	40	U	WN	No	Yes	Yes	No	No

Notes:

(1) Actuators designated "O-C" are for "Open-Close" service. Actuators designated "m" are for "modulating" (throttling) service.

(2) Abbreviations for installation types are as follows:

B4 Buried, depth of 4 feet [1.2 m] or less
B20 Buried, depth greater than 4 feet [1.2 m] but 20 feet [6.1 m] or less
B Buried, depth greater than 20 feet [6.1 m], actual depth of xx feet(Bxx)
SV20 Submerged or vaulted, depth 20 feet [6.1 m] or less
SV Submerged or vaulted, depth greater than 20 feet [6.1 m], actual depth of xx feet(SVXX)
IP In plant

(3) Abbreviations for valve ends are as indicated:

F Flanged
MJ Mechanical joint
P Push-on joint

(4) Abbreviations for manual actuator types are as indicated:

WN Wrench Nut
LVR Lever
CW ChainWheel
HW HandWheel

(5) Abbreviations for high pressure side of plug are as indicated:

S Seating (plug shaft side)
U Unseating (plug seat side)

(6) Abbreviations for limit switches on manual and cylinder operated valves.

EOT End of travel (open - close)
PSS Pump start - stop (two intermediate positions)
ELSCH See electrical schematics

(7) Abbreviations for electronic or electric actuator housing.

WP Weatherproof
SUB Submersible [xx = depth of submergence](SUBxx)
EXP Explosion proof

(8) Abbreviations for control devices are as indicated.

Table 1: Control Devices				
Abbreviations	Open- Close	Open- Stop-	Local- Off-	Red and Green
A	Required		Required	Required
B	Required		Required	
C		Required	Required	Required
D		Required	Required	
E		Required		
F	Required			
G	Required			Required
H		Required		Required

(10) Abbreviations for manual actuator types are as indicated:

SE Standard Electric
PE Programmable Electric
NE Networked Electric

END OF SCHEDULE

THIS PAGE LEFT BLANK INTENTIONALLY

RESILIENT-SEATED GATE VALVES

PART 1 - GENERAL

1-1. SCOPE. This section covers furnishing resilient-seated AWWA gate valves . Resilient-seated gate valves shall be furnished complete with actuators and accessories as specified herein and as specified in the Valve and Gate Actuator section.

1-2. GENERAL. Equipment provided under this section shall be fabricated and assembled in full conformity with drawings, specifications, engineering data, instructions, and recommendations of the equipment manufacturer, unless exceptions are noted by Engineer.

Valves shall be furnished with all necessary parts and accessories indicated on the drawings, specified, or otherwise required for a complete, properly operating installation and shall be the latest standard products of a manufacturer regularly engaged in the production of valves.

1-2.01. General Equipment Stipulations. The General Equipment Stipulations shall apply to all equipment furnished under this section. If requirements in this specification differ from those in the General Equipment Stipulations, the requirements specified herein shall take precedence.

1-2.02. Governing Standard. Except as modified or supplemented herein, all resilient-seated gate valves shall conform to the applicable requirements of ANSI/AWWA C509 or ANSI /AWWA C515.

1-2.03. Temporary Number Plates. Not used.

1-2.04. Permanent Number Plates. Not used.

1-3. SUBMITTALS. Complete drawings, details, and specifications covering the valves and their appurtenances shall be submitted in accordance with the Submittals section.

All valves shall be tested in accordance with Section 5 of the governing standard. Certified copies of the results of all tests, together with an affidavit of compliance as indicated in Section 6.3 of the governing standard, shall be submitted to Engineer before the valves are shipped.

PART 2 - PRODUCTS

2-1. MATERIALS. Except as modified or supplemented herein, materials used in the manufacture of resilient-seated gate valves shall conform to the requirements of the governing standard.

2-1.01. Bronze Components. All bronze valve components in contact with liquid shall contain less than 16 percent zinc. All aluminum bronze components in contact with liquid shall be inhibited against dealuminization in accordance with Section 4.2.2.4.3 of ANSI/AWWA C509.

2-1.02. Gaskets. Gaskets shall be free of asbestos and corrosive ingredients.

2-1.03. Shop Coatings.

Coal Tar Epoxy	High-build coal tar epoxy; Ameron "Amercoat 78HB Coal Tar Epoxy", Carboline "Bitumastic 300 M", Tnemec "46H-413 Hi-Build Tneme-Tar", or Sherwin-Williams "Hi-Mil Sher-Tar Epoxy".
Epoxy	Manufacturer's standard fusion-bonded or liquid epoxy.
Rust-Preventive Compound	As recommended by manufacturer.

2-2. VALVE CONSTRUCTION.

2-2.01. Valve Ends. Valve ends shall be compatible with connecting piping. Tapping valves shall be compatible with tapping sleeve and ends shall be flange by mechanical joint. Except as modified or supplemented herein, the ends shall conform to the applicable requirements of the governing standard.

Flanges shall be finished to true plane surfaces within a tolerance limit of 0.005 inch [125 µm]. The finished face shall be normal to the longitudinal valve axis within a maximum angular variation tolerance of 0.001 inch per inch [1 µm/mm] of flange diameter.

2-2.02. Stem Seals. Valve stems shall be the non-rising type. Stuffing box stem seals shall be provided for all gate valves with rising stems (outside screw-and-yoke type). O-ring stem seals shall be provided for all buried gate valves, and for all gate valves with non-rising stems.

2-2.03. Rotation. The direction of rotation of the handwheel or the wrench nut to open the valve shall be to the left (counterclockwise).

2-2.04. Shop Coating. All interior and exterior ferrous metal surfaces of valves and accessories shall be shop coated for corrosion protection. Except as specified below, the valve manufacturer's standard coating will be acceptable, provided it is functionally equivalent to the specified coating and is compatible with the specified field coating.

Surfaces shall be coated as follows:

Interior surfaces	Epoxy.
Interior surfaces (potable water)	Epoxy (NSF certified).

Exterior surfaces of valves to buried, submerged, or installed in manholes or valve vaults	Epoxy or coal tar epoxy
Exterior surfaces of all other valves	Universal primer.
Polished or machined surfaces	Rust-preventive compound.

The protective epoxy coating on the interior surfaces of each valve shall be applied in three coats, with a minimum total dry film thickness of 13 mils [325 µm]. Alternatively, the manufacturer's standard coating may be used and the interior surfaces of each valve shall be subjected to a nondestructive holiday test in accordance with ASTM G62, Method A, and shall be electrically void-free.

Interior coatings shall comply with AWWA C550. The total dry film thickness of shop-applied coatings shall be not less than:

<u>Type of Coating</u>	<u>Minimum Dry Film Thickness</u>
Coal Tar Epoxy	15 mils [380 µm].
Epoxy	10 mils [250 µm] or 13 mils [325 µm] where specified herein.
Universal Primer	3 mils [75 µm].

2-3. VALVE ACTUATORS. Actuators shall be of the manual type with a wrench nut. Requirements for valve actuators shall be as specified in the Valve and Gate Actuator section.

2-4. ACCESSORIES. When the drawings indicate the need for extension stems, stem guides, position indicators, floor boxes, valve boxes, or operating stands, refer to the Valve and Gate Actuator section.

PART 3 - EXECUTION

3-1. INSTALLATION. Valves will be installed in accordance with Valve Installation section.

3-1.01. Installation Check. An installation check by an authorize representative of the manufacturer is not required.

End of Section

THIS PAGE LEFT BLANK INTENTIONALLY

AIR RELEASE VALVES

PART 1 - GENERAL

1-1. SCOPE. This section covers furnishing air release valves as required by the Work, and as indicated in the Air Release Valve Schedule.

1-2. GENERAL. Equipment provided under this section shall be fabricated and assembled in full conformity with drawings, specifications, engineering data, instructions, and recommendations of the equipment manufacturer, unless exceptions are noted by Engineer.

Valves shall be furnished with all necessary parts and accessories indicated on the drawings, specified, or otherwise required for a complete, properly operating installation and shall be the latest standard products of a manufacturer regularly engaged in the production of valves.

1-2.01. General Equipment Stipulations. The General Equipment Stipulations shall apply to all equipment furnished under this section. If requirements in this specification differ from those in the General Equipment Stipulations, the requirements specified herein shall take precedence.

1-2.02. Governing Standard. Except as modified or supplemented herein, all valves furnished under this section shall conform to the applicable requirements of AWWA C512.

1-2.03. Permanent Number Plates. All valves that have been assigned a number on the drawings or in the Industrial Butterfly Valve Schedule, shall be provided with a permanent number plate. The location of number plates and the method of fastening shall be acceptable to Engineer. Numerals shall be at least 1 inch high and shall be black baked enamel on anodized aluminum plate.

1-3. SUBMITTALS. Complete assembly drawings, together with detailed specifications and data covering materials used and accessories forming a part of the valves furnished, shall be submitted in accordance with the Submittals section.

1-4. DELIVERY, STORAGE, AND HANDLING. Shipping shall be in accordance with the Shipping section. Handling and storage shall be in accordance with the Handling and Storage section.

PART 2 - PRODUCTS

2-1. CONSTRUCTION. Air release valves shall be GA Industries "929BW", APCO "400SBW", Val-Matic "48ABW", Crispin "S20 SB", or ARI "ARI-S-020".

A stainless steel isolation valve shall be provided.

2-2. MATERIALS. Except as modified or supplemented herein, materials of construction shall comply with the governing standard. The use of stressed thermoplastic components will not be acceptable.

Valve Trim	316 stainless steel.
Float	316 stainless steel.

2-3. SHOP PAINTING. Not used.

2-4. SHUTOFF VALVES. A shutoff valve shall be provided in the piping leading to each air release valve.

PART 3 - EXECUTION

3-1. INSTALLATION. Air release valves will be installed in accordance with the Valve Installation section.

End of Section

Schedule 15108-S01

Air Release Valves Schedule

1.000	Requirements	
1.010	Valve Number	VR-3151-01,02,03,04, 05,06,07,08
1.011	Quantity	8 total
1.020	Type (1)	ARV
1.030	Location (2)	Discharge Piping
1.040	Inlet Size	
	inches	2
	mm	
1.050	Outlet Size	
	inches	2
	mm	
1.060	Orifice Size	
	inches	3/32
	mm	
1.070	Inlet Type (3)	T
1.080	Outlet Type (4)	T
1.090	Working Pressure	
	psi	75
	kPa	

Notes:

(1) Abbreviations for types are as indicated:

ARV	Air Release Valve
CAV	Combination Air Valve
ARVR	Air Release and Vacuum Relief Valve

(2) Abbreviations for locations are as indicated:

IP	In-plant
IV	In-vault

(3) Abbreviations for inlet types are as indicated:

T	Threaded, ANSI/ASME B1.20.1, NPT
125F	Flanged, ANSI/ASME B16.1, Class 125
250F	Flanged, ANSI/ASME B16.1, Class 250

(4) Abbreviations for outlet types are as indicated:

T	Threaded, ANSI/ASME B1.20.1, NPT
125F	Flanged, ANSI/ASME B16.1, Class 125
PH	Protective hood

End of Schedule

Section 15111

GATE INSTALLATION

PART 1 - GENERAL

1-1. SCOPE. This section covers the installation of new gates and actuators purchased by Contractor as part of this Work.

The following Sections are applicable to gates to be installed under this contract:

<u>Section</u>	<u>Title</u>
11291	Stainless Steel Sluice Gates

1-2. GENERAL. Equipment installed under this section shall be erected and placed in proper operating condition in full conformity with drawings, specifications, engineering data, instructions, and recommendations of the equipment manufacturer, unless exceptions are noted by Engineer.

1-2.01. General Equipment Stipulations. The General Equipment Stipulations shall apply to all equipment furnished under this section. If requirements in this specification differ from those in the General Equipment Stipulations, the requirements specified herein shall take precedence.

1-2.02. Coordination. When installation checks are provided by the equipment manufacturer, Contractor shall coordinate the services with the equipment manufacturer. Contractor shall give Engineer written notice at least 30 days prior to the need for installation checks.

1-3. DELIVERY, STORAGE, AND HANDLING. Upon delivery, all equipment and materials shall immediately be stored and protected by Contractor in accordance with the Handling and Storage section until installed in the Work. Equipment shall be protected by Contractor against damage and exposure from the elements. At no time shall the equipment be stored on earth or grass surfaces or come into contact with earth or grass. Contractor shall keep the equipment dry at all times.

PART 2 – PRODUCTS. Not used.

PART 3 - EXECUTION

3-1. INSPECTION. All gates and accessories shall be inspected for damage and cleanliness before being installed. Any material damaged or contaminated in handling on the job shall not be used unless it is repaired and recleaned to the original requirements by Contractor. Such material shall be segregated from the clean material and shall be inspected and approved by Owner or his representative before its use.

3-2. INSTALLATION.

3-2.01. General. Gates and appurtenances shall be handled and installed in accordance with the manufacturer's recommendations, and the requirements herein.

All bolts shall be tightened and all items requiring lubrication, including pivot pins, shall be lubricated. Anti-seize thread lubricant shall be liberally applied to the threaded portion of stainless steel anchor bolts during the installation and tightening of nuts. Excess lubricant shall be thoroughly removed following final tightening.

The threaded portion of each plastic stem cover shall be wrapped in at least two layers of teflon thread tape, and the threaded portion of steel pipe stem covers shall be coated with teflon thread sealer immediately prior to installation of the cover on the actuator.

Each gate shall be adjusted so that it does not bind or leak in excess of specified requirements. After installation, each gate shall be operated through at least two complete open-close cycles, re-adjusted and re-operated as necessary, and left in a condition acceptable to Engineer.

3-2.02. Installation Checks. When specified in the gate sections, the gate manufacturer will provide installation checks. For installation checks, the manufacturer's field representative will inspect the gate installation immediately following installation by Contractor. The manufacturer's representatives will revisit the site as often as necessary to ensure installation satisfactory to Owner.

Contractor shall perform no Work related to the installation or operation of materials or equipment furnished by others without direct observation and guidance of the field representative, unless Engineer and manufacturer furnishing such materials concur otherwise.

3-2.03. Sluice Gates. Not used.

3-2.04. Stainless Steel Sluice Gates. Each embedded frame shall be carefully braced in the forms before concrete is placed, or a space shall be boxed out and the frame shall be grouted in place later. Care shall be exercised to ensure that frame members and anchor bolts do not rest upon or contact steel reinforcing bars.

Damaged areas of shop-applied coatings shall be re-coated and allowed to cure before placement of concrete or grout. Anchor bolts shall be carefully set using a template.

3-2.05. Flap Gates. Not used.

3-2.06. Tilting Weirs in Aeration Basins. Not used.

3-3. GATE ACTUATORS. Gate actuators and accessories shall be installed in accordance with the equipment manufacturer's recommendations.

3-4. FIELD QUALITY CONTROL.

3-4.01. Field Leakage Testing. After installation, all gates shall be tested for leakage.

Leakage exceeding the specified limits which is discovered within the correction period stipulated in the General Conditions shall be repaired by and at the expense of Contractor. This requirement applies whether pressure testing is required or not.

3-4.01.01. Stainless Steel Sluice Gates. For the maximum seating and unseating heads, the leakage shall not exceed 0.1 gpm per foot of seating perimeter.

3-5. ADJUSTING. After installation, the opening and closing time shall be adjusted as needed for each electric actuated gate.

End of Section

This page was left blank intentionally

PRESSURE GAUGES

PART 1 - GENERAL

1-1. SCOPE. This section covers analog dial-type gauges and accessories to be furnished and installed at the locations indicated on the drawings and as specified in the Gauge Schedule at the end of this section.

Gauges to be furnished by an equipment supplier, either with an item of equipment or as a component of an equipment package, are covered in the applicable equipment section.

Gauge piping and fittings are covered in other sections.

1-2. GENERAL.

1-2.01. General Equipment Stipulations. The General Equipment Stipulations shall apply to all equipment furnished under this section. If requirements in this specification differ from those in the General Equipment Stipulations, the requirements specified herein shall take precedence.

1-2.02. Governing Standard. Except as modified or supplemented herein, all gauges shall conform to the requirements of ANSI/ASME B40.1.

1-2.03. Accuracy Grade. Unless otherwise specified, gauge accuracy shall be ANSI Grade 2A or better. Overall accuracy for diaphragm seal protected and liquid-filled gauges shall be ANSI Grade A or better.

1-3. SUBMITTALS. Complete drawings or catalog cuts, together with detailed specifications and data covering materials used, shall be submitted in accordance with the Submittals section.

PART 2 - PRODUCTS

2-1. GAUGE CONSTRUCTION. Gauges shall be stainless steel dial type with moving stainless pointer, liquid filled, stem mounted, range 0 to 30 psi, Buna-N multi-function plug with removable nipple, , shatterproof sealed case window with Buna-N gasket, silicone filled, 316 stainless steel Bourdon tube, 1/2" NPT stainless steel stem, accuracy +/- 1% of space. Pressure gauges shall be Ashcroft "Model 40-10090-60", H.O. Trerice Co. "700 LFSS-G-40-FSL 250 PSI 100", Winter Gauges "Q770 0-60 PSI", or Palmer Gauges "45-S-W-Q-60#-J"..

The dial shall be 4 inches in diameter, with white background and black markings. The units of measurement shall be indicated on the dial face. Subdivisions of the scale shall conform to the requirements of the governing standard. Pointer travel shall be not less than 200 degrees nor more than 270 degrees of arc.

Unless otherwise indicated, pressure gauges shall measure in psig. All gauges shall have a suitable range to give mid-scale readings under normal conditions

2-2. GAUGE ACCESSORIES.

2-2.01. Isolation Valves. Each gauge shall be provided with a threaded end ball-type shutoff valve as specified in the Miscellaneous Ball Valves section.

2-2.02. Gauge Isolators.

2-2.02.01. In-line Diaphragm Seals. In-line, flow-through type diaphragm seals shall be provided where indicated on the drawings.

For in-line diaphragm seals in pipe 4 inches and larger, flange type gauge isolators shall be provided. Diaphragm seals shall be Ashcroft "Type 200", H.O. Trerice "'01FF", or Winter "D950 top D954 bottom".

Each diaphragm seal and the gauge served shall be factory assembled, filled with a suitable fluid, and calibrated as a unit.

PART 3 - EXECUTION

3-1. INSTALLATION. Gauges shall be installed at the locations indicated on the drawings. Installation configurations shall conform to the requirements of the detail indicated on the drawings.

All gauges and diaphragm seals shall be installed in the vertical upright position. Threaded connections shall be assembled using teflon thread tape or teflon thread sealer, as specified in the Miscellaneous Piping and Accessories Installation section. Teflon thread sealer shall not be used for liquid oxygen or oxygen gas piping. All connections shall be free from leaks.

Lines shall be purged of trapped air at gauge locations prior to installation of the gauge or diaphragm seal.

End of Section

PIPE SUPPORTS

PART 1 - GENERAL

1-1. SCOPE. This section covers the furnishing and installation of pipe hangers, brackets, and supports. Pipe supports shall be furnished complete with all necessary inserts, bolts, nuts, rods, washers, and other accessories. This section also covers the spacing of expansion joints in piping systems. Expansion joint products and materials are covered in the respective piping sections.

Concrete and fabricated steel supports shall be as indicated on the drawings, as specified in other sections, or, in the absence of such requirements, as permitted by Engineer.

This section covers pipe supports for the following pipe materials:

- Cast or ductile iron
- Stainless Steel
- Hot-dip galvanized steel
- Steel (other)
- PVC/CPVC Schedule 80 (other)
- FRP (LP)

1-2. GENERAL. Pipe supports, anchors, and expansion joints have been indicated on the drawings in certain locations, but no attempt has been made to indicate every pipe support, anchor, and expansion joint. It shall be Contractor's responsibility to provide a complete system of pipe supports, to provide expansion joints, and to anchor all piping, in accordance with the requirements specified herein. Additional pipe supports may be required adjacent to expansion joints, couplings, or valves. When supports are shown on the drawings, Contractor shall not relocate supports without Engineer's approval.

All piping shall be rigidly supported and anchored so that there is no movement or visible sagging between supports.

Pipe supports and expansion joints are not required in buried piping, but concrete blocking or other suitable anchorage shall be provided as indicated on the drawings or specified in other sections.

Piping support system components shall comply with specified piping code requirements.

1-2.01. General Equipment Stipulations. The General Equipment Stipulations shall apply to all equipment furnished under this section. If requirements in this specification differ from those in the General Equipment Stipulations, the requirements specified herein shall take precedence.

1-3. SUBMITTALS. Complete data and catalog cuts or drawings covering fabricated pipe supports, fabricated inserts, and stainless steel, galvanized, and copper- and plastic-coated pipe supports shall be submitted in accordance with the Submittals section.

Data shall include a listing of the intended use and general location of each item submitted.

PART 2 - PRODUCTS

2-1. MATERIALS. Unless otherwise indicated, all pipe supports shall comply with ANSI/MSS SP-58 and MSS SP-69. Materials of construction for fabricated steel supports are covered in the Structural and Miscellaneous Metals section. All pipe support materials shall be packaged as necessary to ensure delivery in satisfactory condition.

Unless otherwise specified or indicated on the drawings, pipe supports shall be fabricated of manufacturer's standard materials and provided with manufacturer's standard finish.

Design loads for inserts, brackets, clamps, and other support items shall not exceed the manufacturer's recommended loads.

Pipe supports shall be manufactured for the sizes and types of pipe to which they are applied. Strap hangers will not be acceptable. Threaded rods shall have sufficient threading to permit the maximum adjustment available in the support item. Continuously threaded rod is not acceptable for hanger rods over 12 inches in length.

Unless otherwise acceptable to Engineer, the use of supports which rely on stressed thermoplastic components to support the pipe will not be acceptable.

Contact between dissimilar metals, including contact between stainless steel and carbon steel, shall be prevented. Supports for brass or copper pipe or tubing shall be copper plated. Portions of pipe supports which come into contact with other metals that are dissimilar shall be rubber or vinyl coated.

Stainless steel supports shall be furnished, and shall be AISI Type 304 or 316 stainless steel. Stainless steel supports fabricated by welding shall be AISI Type 304L or 316L.

Hot-dip galvanized supports shall be furnished and shall be in accordance with ASTM A153 and A385.

Pipe support types and application shall comply with Table 1.

2-2. WIND AND SEISMIC LOADS. For pipe supports that are designed by the Contractor, wind and seismic loads shall be considered in the design. The applicable building code and design criteria are included in the structural general notes on the drawings.

PART 3 - EXECUTION

3-1. APPLICATION. Concrete inserts or anchor bolts shall be used to support piping from new cast-in-place concrete. Expansion anchors shall be used to fasten supports to existing concrete and masonry.

Anchorage shall be provided to resist thrust due to temperature changes, changes in diameter or direction, or dead-ending. Anchors shall be located as specified to force expansion and contraction movement to occur at expansion joints, loops, or elbows, and as needed to prevent excessive bending stresses and opening of mechanical couplings. Anchorage for temperature changes shall be centered between elbows and mechanical joints used as expansion joints. Anchorage for bellows type expansion joints may be located adjacent to the joint.

When expansion joints are required, pipe guides shall be provided adjacent to bellows type expansion joints. Guides will not be required where mechanical couplings are permitted as expansion joints. Guides shall be located on both sides of expansion joints, except where anchors are adjacent to the joint. Unless otherwise indicated on the drawings, one guide shall be within four pipe diameters from the joint and a second guide within 14 pipe diameters from the first guide. Pipe supports shall allow adequate movement; pipe guides shall not be used for support. Pipe guides shall be provided at locations as recommended by the manufacturer.

Pipe supports for insulated cold piping systems shall be sized for the outside diameter of the insulated pipe, and an insulation protection shield shall be installed between the support and the insulation. Rigid insulation inserts shall be installed between the pipe and the insulation shields for piping larger than 2 inches or when needed to prevent crushing of the insulation. Inserts shall be of the same thickness as the adjacent insulation and shall be vapor sealed.

Insulated hot piping systems shall be supported by clevises, clamps, support saddles, or rollers. Pipe clamps shall be attached directly to the pipe. Support saddles and rollers shall be sized for the outside diameter of the insulated pipe, and an insulation protection saddle shall be installed at the support.

When supports for the FRP piping systems are in contact with less than 180 degrees of the pipe surface or when the width of the support is less than one-third the nominal pipe diameter (4 inches minimum), an FRP or steel saddle, shaped to the outside diameter of the pipe, shall be bonded to at least the bottom 120 degrees of the pipe.

3-2. TYPES OF SUPPORTS. The specific products for pipe supports shall be as indicated in Table 1 for the specified type and size of support.

TABLE 1 - TYPES OF SUPPORTS

Description and Service	MSS SP 69 (Note 1)	Type	
			Other
Hangers 2-1/2 inch [63 mm] and smaller pipe For hot and cold insulated piping Clevis	1		B-Line "B3100" or Anvil "260".

TABLE 1 - TYPES OF SUPPORTS

Description and Service	MSS SP 69 (Note 1)	Type
		Other
Other services		
J-style	5	B-Line "B3690", Anvil "67", or Unistrut "J Hanger".
Clevis	1	B-Line "B3104" or Anvil "65".
3 Through 10 inch [75 through 250 mm] pipe		
For hot insulated piping		
Double bolt	3	B-Line "B3144" or Anvil "295".
For cold insulated piping		
Clevis	1	B-Line "B3100" or Anvil "260".
For uninsulated cold piping		
Clamp	4	B-Line "3140" or Anvil "212".
Clevis	1	B-Line "B3100" or Anvil "260".
Other services		
Clevis	1	B-Line "B3100" or Anvil "260" for steel pipe; B-Line "B3102" or Anvil "590" for cast iron pipe.
12 inch [300 mm] pipe		
Clevis or saddle	1	See drawings.
14 inch [350 mm] and larger pipe		
Saddle	--	See drawings.
Concrete Inserts, Steel		
12 inch [300 mm] and smaller pipe	18	Channel 12 ga [2.66 mm thick], galv, 1-5/8 by 1-3/8 inches [41.3 by 34.9 mm], min. 8 inches [200 mm] long, anchor lugs on 4 inch [100 mm] centers, at least three lugs, end caps, and filler strip.
14 inch [350 mm] and larger pipe, fabricated insert, except as noted	--	See drawings.
Beam Clamps, Malleable Iron or Steel, 12 inch [300 mm] and smaller pipe	21 28, 29 30	B-Line "3050" and "3055" or Anvil "133" and "134". Anvil "292". B-Line "3054" or Anvil "228".
Side Beam Bracket	34	B-Line "B3062" or Anvil "202".
Wall Supports and Frames, Steel, 12 inch [300 mm] and smaller pipe (Note 2)		

TABLE 1 - TYPES OF SUPPORTS

Description and Service	MSS SP 69 (Note 1)	Type
		Other
Brackets	32	B-Line "B3066" or Anvil "195".
	33	B-Line "B3067" or Anvil "199".
Prefabricated channels	--	12 ga [2.66 mm thick], galv, 1-5/8 inches [41.3 by 41.3 mm], with suitable brackets and pipe clamps.
Offset pipe clamp, 1-1/2 inch [38 mm] and smaller pipe	--	Galv, 1-1/4 by 3/16 inch [32 by 4.7 mm] steel, with 3/8 inch [9.5 mm] bolts.
Offset pipe clamp, 2 to 3-1/2 inch [50 to 88 mm] pipe	--	Galv, 1-1/4 by 1/4 inch [32 by 6 mm] steel, with 3/8 inch [9.5 mm] bolts.
Floor Supports, Steel or Cast Iron		
6 inch [150 mm] and smaller pipe	37 (with base)	B-Line "B3090" or Anvil "259".
8 through 24 inch [200 to 600 mm] pipe	38	B-Line "B3093" or Anvil "264".
Pipe Alignment Guides	--	B-Line "B3281" through "B3287" or Anvil "255".
Turnbuckles Steel	13	B-Line "B3202" or Anvil "230".
Hanger Rods, Carbon Steel, Threaded Both Ends, 3/8 inch [10 mm] minimum size	--	B-Line "B3205" or Anvil "140".
Weldless Eye Nut, steel	17	B-Line "B3200" or Anvil "290".
Insulation Protection Saddle	39	B-Line "B3160 Series" or Anvil "160 Series".
Insulation Protection Shield	40	B-Line "B3151" or Anvil "167".

Table 1 Notes:

1. MSS SP-69 supports and hangers are illustrated on Figure 1-15140.
2. Pipe clamps or other devices which rely on the application of a clamping force to the supported pipe in order to maintain the clamp position or location in a prefabricated channel or track will not be acceptable for use with nonmetallic pipe or tubing.

3-3. **SUPPORT SPACINGS.** Pipe supports and expansion joints shall be spaced in accordance with Tables 2, 3, 4, and 5. The types of pipes to be supported are as specified herein. Table 2 covers spacings for the standard operating conditions specified for each pipe material. Tables 3 and 4 cover PVC and FRP pipe spacings where operating conditions are in excess of the temperature and specific gravity requirements covered in Table 2. Table 5 covers PVC and FRP pipe which carries air or liquids with a specific gravity other than 1.0.

TABLE 2 – MAXIMUM PIPE SUPPORT SPACINGS AT STANDARD TEMPERATURES AND SERVICES

Type of Pipe	Pipe Support Max Spacing	Max Run Without Expansion Joint, Loop, or Bend (Note 1)	Expansion Joint Max Spacing (Note 2)	Type of Expansion Joints
	feet [m]	feet [m]	feet [m]	
Cast iron or Ductile iron	15 [4.5]	80 [24.4]	80 [24.4]	Note 6
Steel, for other services				
1-1/4 inch [31 mm] and smaller	7 [2.1]	30 [9.1]	100 [30.5]	Note 3
1-1/2 to 4 inch [38 to 100 mm]	10 [3.0]	30 [9.1]	100 [30.5]	Note 3
Over 4 inch [100 mm]	15 [4.5]	80 [24.4]	80 [24.4]	Note 6
Stainless steel				
1-1/4 inch [31 mm] and smaller	7 [2.1]	30 [9.1]	100 [30.5]	Note 3
1-1/2 to 4 inch [38 to 100 mm]	10 [3.0]	30 [9.1]	100 [30.5]	Note 3
Over 4 inch [100 mm]	15 [4.5]	80 [24.4]	80 [24.5]	Note 3
PVC, Schedule 80, for other services at a maximum temperature of 100°F [38°C] and a maximum specific gravity of 1.0.				
1/8 and 1/4 inch [3 and 6 mm]	Continuous Support	20 [6.1]	60 [18.3]	Note 3
1/2 inch [13 mm]	4 [1.2]	20 [6.1]	60 [18.3]	Note 3
3/4 inch [19 mm]	4-1/2 [1.3]	20 [6.1]	60 [18.3]	Note 3
1 and 1-1/4 inch [25 and 31 mm]	5 [1.5]	20 [6.1]	60 [18.3]	Note 3
1-1/2 and 2 inch [38 and 50 mm]	5-1/2 [1.6]	20 [6.1]	60 [18.3]	Note 3
2-1/2 inch [63 mm]	6 [1.8]	20 [6.1]	60 [18.3]	Note 3
3 inch [75 mm]	7 [2.1]	20 [6.1]	60 [18.3]	Note 3
4 inch [100 mm]	7-1/2 [2.3]	20 [6.1]	60 [18.3]	Note 3

TABLE 2 – MAXIMUM PIPE SUPPORT SPACINGS AT STANDARD TEMPERATURES AND SERVICES

Type of Pipe	Pipe Support Max Spacing	Max Run Without Expansion Joint, Loop, or Bend (Note 1)	Expansion Joint Max Spacing (Note 2)	Type of Expansion Joints
	feet [m]	feet [m]	feet [m]	
6 inch [150 mm]	8-1/2 [2.6]	20 [6.1]	60 [18.3]	Note 3
8 inch [200 mm]	9-1/2 [2.8]	20 [6.1]	60 [18.3]	Note 3
10 inch [250 mm]	10 [3.0]	20 [6.1]	60 [18.3]	Note 3
12 inch [300 mm]	11 [3.3]	20 [6.1]	60 [18.3]	Note 3
FRP, for low pressure and odor control pipe at a maximum temperature of 150°F [66°C] and a maximum specific gravity of 1.0.				
1 inch [25 mm]	4 [1.2]	60 [18.3]	100 [30.5]	Note 3
1-1/2 inch [38 mm]	4-1/2 [1.3]	60 [18.3]	100 [30.5]	Note 3
2 inch [50 mm]	5-1/2 [1.6]	60 [18.3]	100 [30.5]	Note 3
3 inch [76 mm]	6 [1.8]	60 [18.3]	100 [30.5]	Note 3
4 inch [100 mm]	6-1/2 [2]	40 [12.2]	100 [30.5]	Note 3
6 inch [150 mm]	7-1/2 [2.3]	40 [12.2]	100 [30.5]	Note 3
8 inch [200 mm]	8-1/2 [2.6]	40 [12.2]	100 [30.5]	Note 3
10 inch [250 mm]	9-1/2 [2.8]	40 [12.2]	100 [30.5]	Note 3
12 inch [300 mm] and larger	10 [3.0]	40 [12.2]	100 [30.5]	Note 3

Table 2 Notes:

1. Unless otherwise acceptable to Engineer, an expansion joint shall be provided in each straight run of pipe having an overall length between loops or bends exceeding the maximum run specified herein.
2. Unless otherwise acceptable to Engineer, the spacing between expansion joints in any straight pipe run shall not exceed the maximum spacing specified herein.

3. Expansion joint fittings are specified in the respective piping procurement sections.
4. At least two properly padded supports for each pipe section.
5. At least one support for each pipe section.
6. Expansion joints shall be mechanical couplings.
7. No expansion joints are required.
8. Supports for 5 and 10 foot [1.5 and 3 m] long pipe sections shall be located within 18 inches [460 mm] of each joint. Supports shall be positioned to maintain the piping alignment and to prevent the piping from sagging.

3-3.01. Temperature Adjustments for PVC Pipe. Not used.

3-3.02. Temperature Adjustments for FRP Pipe. Not used.

3-3.03. Specific Gravity Adjustments for PVC and FRP Pipe. Not used.

3-4. INSTALLATION.

3-4.01. General. All piping shall be supported in a manner which will prevent undue stress on any valve, fitting, or piece of equipment. In addition, pipe supports shall be provided at changes in direction or elevation, adjacent to flexible couplings, and where otherwise shown. Pipe supports and hangers shall not be installed in equipment access areas.

Where horizontal piping is arranged with two or more parallel lines, trapeze hangers may be used in lieu of individual hangers. Trapeze assembly shall consist of structure attachments as previously specified with rod size dependent upon total weight supported. Spacing of assemblies shall be determined by the minimum pipe size included in the group supported. Trapeze horizontal assemblies shall be structural angle or channel section of sufficient size to prevent measurable sag between rods. All lines shall be attached to the horizontal with intermediate pipe guides and U-bolts or one-hole clamps. Pre-engineered support equipment may be used when selected and installed in accordance with the manufacturer's recommendations.

No copper pipe shall contact a pipe support or hanger of dissimilar metal. Hangers and supports for copper pipe shall be copper-plated, plastic coated, or copper pipe shall be galvanically isolated using Neoprene strips or other material as approved.

No piping shall be supported from the pipe above.

Horizontal piping hanger support rods shall attach to steel beams with center-loading I-clamps, or welded beam clips. Hanger support rods shall attach to concrete slabs or beams with inserts.

Anchorage shall be provided to resist both lateral and longitudinal seismic forces. Seismic forces shall be calculated assuming the pipes are full.

3-4.02. Inserts. Reference building structural concrete drawings for concrete inserts. When not provided as part of the building concrete structure, provide inserts for suspending hangers from reinforced concrete slabs and sides of reinforced concrete beams.

Where concrete slabs form finished ceilings, provide inserts flush with the slab surface.

Where inserts are omitted, drill through concrete slab from below and provide thru-bolt with recessed square steel plate and nut recessed into and grouted flush with slab. X-ray locate existing reinforcing rods before drilling.

3-4.03. Pipe Hangers and Supports. Hanger rod sizing for copper pipe and plastic pipe shall be same as for steel pipe. Install hangers to provide a minimum 1/2 inch [13 mm] space between finished covering and adjacent work.

A hanger shall be placed with 18 inches of each horizontal elbow, and on both sides of all piping accessories and valves weighing 20 lbs [9 kg] or more.

Hangers shall have 1-1/2 inches minimum vertical adjustment.

Support horizontal cast iron, ductile iron and no-hub piping systems adjacent to each joint.

Support vertical piping at every floor using riser clamps.

Support riser piping independently of connected horizontal piping.

Hanger and hanger components shall be sized specifically for the pipe size it is to be used on.

3-5. PLACEMENT. Unless closer spacing is indicated on the drawings, the maximum spacing for pipe supports and expansion joints shall be as indicated in Tables 2, 3, 4, and 5.

Rubber hose and flexible tubing shall be provided with continuous angle or channel support.

Unless otherwise indicated on the drawings or acceptable to Engineer, piping shall be supported approximately 1-1/2 inches out from the face of walls and at least 3 inches below ceilings.

End of Section

This page was left blank intentionally

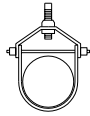

ADJ. STEEL CLEVIS
TYPE-1



ADJ. STEEL
BAND HGR
TYPE-7



STEEL TURNBUCKLE
TYPE-13



TOP BEAM
C-CLAMP
TYPE-19

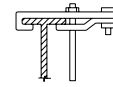

TOP I-BEAM CLAMP
TYPE-25

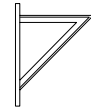

LIGHT WELDED
STEEL BRACKET
TYPE-31

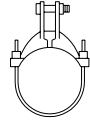

ALLOY STEEL
PIPE CLAMP
TYPE-2



EXTENSION PIPE ON
RISER CLAMP
TYPE-8



STEEL CLEVIS
TYPE-14



SIDE I-BEAM ON
CHANNEL CLAMP
TYPE-20



CLIP
TYPE-26

MEDIUM WELDED
STEEL BRACKET
TYPE-32

HEAVY WELDED
STEEL BRACKET
TYPE-33

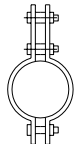

CARBON OR ALLOY
STEEL DOUBLE BOLT
PIPE CLAMP
TYPE-3

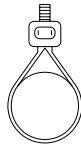

ADJUSTABLE
BAND HGR
TYPE-9



SWIVEL
TURNBUCKLE
TYPE-15



CENTER I-BEAM
TYPE-21

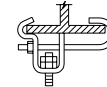

SIDE I-BEAM CLAMP
TYPE-27



SIDE BEAM BRACKET
TYPE-34

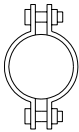

STEEL PIPE CLAMP
TYPE-4



ADJ. SWIVEL RING
BAND TYPE
TYPE-10



MALLEABLE
IRON SOCKET
TYPE-16



WELDED
ATTACHMENT
TYPE-22
AS SHOWN OR
INVERTED LESS BOLT

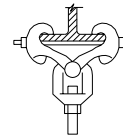

STEEL I-BEAM CLAMP
W/ EYE NUT
TYPE-28

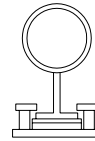

PIPE SLIDE &
SLIDE PLATE
TYPE-35



PIPE HANGER
TYPE-5

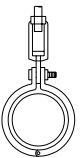

SPLIT PIPE W/WD
TURNBUCKLE ADJ.
TYPE-11



STEEL WELDLESS
EYE NUT
TYPE-17



C-CLAMP
TYPE-23

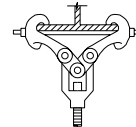

STEEL W.F. CLAMP
W/ EYE NUT
TYPE-29



PIPE SADDLE
SUPPORT
TYPE-36



ADJ. SWIVEL PIPE RING
SPLIT RING TYPE OR
SOLID RING TYPE
TYPE-6

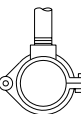

EXTENSION SPLIT
PIPE CLAMP
HINGED OR TWO BOLT
TYPE-12

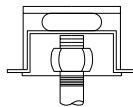

STEEL OR MALLEABLE
CONCRETE INSERT
TYPE-18



U-BOLT
TYPE-24

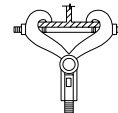

MALLEABLE BEAM CLAMP
W/EXTENSION PIECE
TYPE-30



PIPE STANCHION
SADDLE
TYPE-37

HANGERS AND SUPPORTS

This page was left blank intentionally

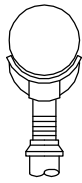

ADJUSTABLE PIPE SADDLE SUPPORT TYPE-38

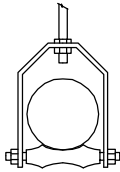

ADJUSTABLE ROLLER HANGER W/NO SWIVEL TYPE-43

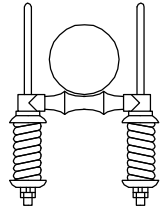

SPRING CUSHION ROLL TYPE 49

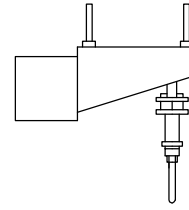

CONSTANT SUPPORT HORIZONTAL TYPE TYPE-54

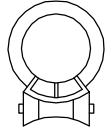

STEEL PIPE COVER PROTECTION SADDLE TYPE 39

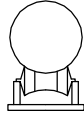

PIPE ROLL COMPLETE TYPE 44

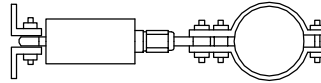

SPRING SWAY BRACE TYPE 60

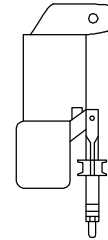

CONSTANT SUPPORT VERTICAL TYPE TYPE-65

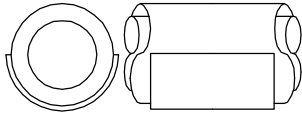

PROTECTION SHIELD TYPE-41

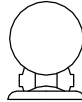

PIPE ROLL & PLATE TYPE-45

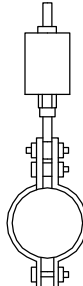

VARIABLE SPRING HANGER TYPE-61

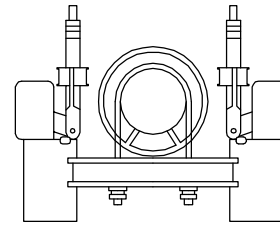

CONSTANT SUPPORT TRAPEZE TYPE TYPE-64

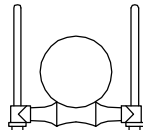

SINGLE PIPE ROLL TYPE-41

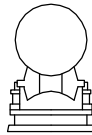

ADJUSTABLE PIPE ROLL & BASE TYPE-46

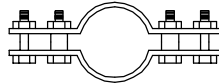

CARBON OR ALLOY STEEL RISER CLAMP TYPE-42

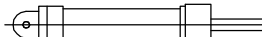

RESTRAINT CONTROL DEVICE TYPE-47

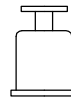

VARIABLE SPRING BASE SUPPORT TYPE-62

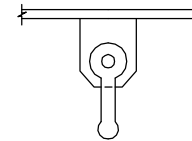
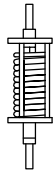
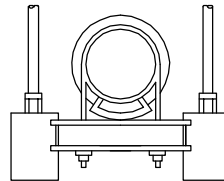

PLATE LUG TYPE-67



SPRING CUSHION TYPE-48



VARIABLE SPRING TRAPEZE HANGER TYPE-53

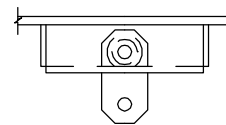

HORIZONTAL TRAVELER TYPE-58

HANGERS AND SUPPORTS

This page was left blank intentionally

VALVE AND GATE ACTUATORS

PART 1 - GENERAL

1-1. SCOPE. This section covers furnishing manual and powered valves and gate actuators and accessories as specified herein.

1-2. GENERAL. Equipment provided under this section shall be fabricated and assembled in full conformity with drawings, specifications, engineering data, instructions, and recommendations of the equipment manufacturer, unless exceptions are noted by Engineer.

Actuators shall be furnished with all necessary parts and accessories indicated on the drawings, specified, or otherwise required for a complete, properly operating installation and shall be the latest standard products of a manufacturer regularly engaged in the production of actuators.

1-2.01. General Equipment Stipulations. The General Equipment Stipulations shall apply to all equipment furnished under this section. If requirements in this specification differ from those in the General Equipment Stipulations, the requirements specified herein shall take precedence.

1-2.02. Governing Standards. Except as modified or supplemented herein, all powered actuators shall conform to applicable requirements of ANSI/AWWA C540.

Except as modified or supplemented herein, all manual and cylinder actuators for butterfly and eccentric plug valves shall conform to the applicable requirements of ANSI/AWWA C504.

Except as modified or supplemented herein, all manual actuators for ball valves shall conform to the applicable requirements of ANSI/AWWA C507.

Except as modified or supplemented herein, all manual actuators for sluice and slide gates shall conform to the applicable requirements of ANSI/AWWA C560.

1-2.03. Power Supply. Power supply to electric actuators will be 480-volts three phase.

1-2.04. Marking. Each actuator shall be marked with the manufacturer's name, model number, and the country of origin. An identifying serial number shall be stamped on a corrosion-resistant plate attached to the actuator.

1-2.05. Temporary Number Plates. Each actuator shall be factory tagged or marked to identify the actuator and the applicable valve or gate by number or service as indicated in the valve or gate schedule.

1-3. SUBMITTALS. Complete drawings, details, and specifications covering the actuators and their appurtenances shall be submitted in accordance with the Submittals section. Submittal drawings shall clearly indicate the country of origin of each actuator and its components.

The drawings shall include separate wiring diagrams for each electrically operated or controlled actuator and the electrical control equipment. Each actuator drawing shall be identified with the respective valve number or name.

For electric or cylinder actuators, certified copies of reports covering proof-of-design testing of the actuators as set forth in Section 5 of ANSI/AWWA C540, together with an affidavit of compliance as indicated in Section 6.3 of ANSI/AWWA C540, shall be submitted to Engineer before the actuators are shipped.

1-4. DELIVERY, STORAGE, AND HANDLING. Shipping shall be in accordance with the Shipping section. Handling and storage shall be in accordance with the Handling and Storage section.

PART 2 - PRODUCTS

2-1. PERFORMANCE AND DESIGN REQUIREMENTS.

2-1.01. General. Actuators and appurtenances shall be designed for the conditions and requirements as indicated in the respective valve and gate sections.

Liberal factors of safety shall be used throughout the design, especially in the design of parts subject to intermittent or alternating stresses. In general, working stresses shall not exceed one-third of the yield point or one-fifth of the ultimate strength of each material.

2-1.02. Valve Actuators. Each actuator shall be designed to open or close the valve under all operating conditions. Actuators shall be designed for the maximum pressure differential across the valve and maximum velocities through the valve where indicated in the respective valve schedules.

Valve actuators shall be provided and adjusted by the valve manufacturer. Actuator mounting arrangements and positions shall facilitate operation and maintenance and shall be determined by the valve manufacturer unless indicated otherwise on the drawings or directed by Engineer.

When valves are to be buried, submerged, or installed in vaults, the actuators and accessories shall be sealed to prevent the entrance of water. The design water depth shall be as indicated in the respective valve schedules but not less than 20 feet [6.1 m].

2-1.03. Gate Actuators. Actuators shall be sized to produce the torque or thrust required to operate the gate when subject to the seating and unseating operating heads as indicated in the respective gate schedules.

Both the design head and the operating head shall be measured from the surface of the liquid to the center line of the gate.

2-1.04. Limit Switches. Limit switches shall be provided as indicated on the drawings or in the valve and gate schedules.

For manual or cylinder type actuators, each limit switch shall be heavy duty type, with a cast NEMA Type 4 enclosure, a spring return roller lever, and four isolated contacts (two normally open and two normally closed) rated 10 amperes at 120 to 480 volts ac and 5 amperes at 125 volts dc. The switches shall be Allen Bradley "802T" or Square D "9007 Type C".

Limit switches for programmable and standard electric actuators shall be as indicated in their respective paragraphs.

2-2. MATERIALS. Except as modified or supplemented herein, materials used in the manufacture of actuators shall conform to the requirements of ANSI/AWWA C504 and C540.

2-3. VALVE MANUAL ACTUATORS.

2-3.01. General. Manual actuators of the types listed in the valve specifications or schedules shall be provided by the valve manufacturer.

Unless otherwise indicated or specified, each geared manual actuator shall be equipped with an operating handwheel.

The direction of rotation of the wheel, wrench nut, or lever to open the valve shall be to the left (counterclockwise). Each valve body or actuator shall have cast thereon the word "Open" and an arrow indicating the direction to open.

The housing of traveling-nut type actuators shall be fitted with a removable cover which shall permit inspection and maintenance of the operating mechanism without removing the actuator from the valve. Travel limiting devices shall be provided inside the actuator for the open and closed positions. Travel limiting stop nuts or collars installed on the reach rod of traveling-nut type operating mechanisms shall be field adjustable and shall be locked in position by means of a removable roll pin, cotter pin, or other positive locking device. The use of stop nuts or adjustable shaft collars which rely on clamping force or setscrews to prevent rotation of the nut or collar on the reach rod will not be acceptable.

Each actuator shall be designed so that shaft seal leakage cannot enter the actuator housing.

Valves for throttling service shall be equipped with an infinitely variable locking device or a totally enclosed gear actuator.

Actuators shall produce the required torque with a maximum pull of 80 lbs [356 N] on the lever, handwheel, or chain. Actuator components shall withstand, without damage, a pull of 200 lbs [890 N] on the handwheel or chainwheel or an input of 300 foot-lbs [407 J] on the operating nut.

2-3.02. Handwheels. Handwheel diameters shall be at least 8 inches [200 mm] but not more than 24 inches [600 mm] for 30 inch [750 mm] and smaller valves and not more than 30 inches [750 mm] for 36 inch [900 mm] and larger valves.

2-3.03. Chainwheels. Unless otherwise specified in the valve schedules, all valves with center lines more than 7'-6" [2.3 m] above the floor shall be provided with chainwheels and operating chains. Each chainwheel operated valve shall be equipped with a chain guide which will permit

rapid handling of the operating chain without "gagging" of the wheel and will also permit reasonable side pull on the chain. Suitable extensions shall be provided, if necessary, to prevent interference of the chain with adjacent piping or equipment. Operating chains shall be hot-dip galvanized or zinc plated carbon steel and shall be looped to extend to within 4 feet [1.2 m] of the floor below the valve.

2-3.04. Levers. Levers shall be capable of being locked in at least five intermediate positions between fully open and fully closed. In any building or structure containing lever operated valves, at least two operating levers shall be provided for each size and type of lever operated valve.

2-3.05. Chain Levers. Suitable actuator extensions shall be provided, if necessary, to prevent interference of the chain with adjacent piping or equipment. Operating chains shall be hot-dip galvanized carbon steel and shall be looped to extend to within 4 feet [1.2 m] of the floor below the valve.

2-3.06. Wrench Nuts. Unless otherwise specified in the valve schedules or on the drawings, wrench nuts shall be provided on all buried valves and on all valves that are to be operated through floor boxes. Unless otherwise directed by Owner, all wrench nuts shall comply with Section 4.4.13 of AWWA C500. At least two operating keys shall be furnished for operation of the wrench nut operated valves.

2-3.07. Operating Stands. Operating stands shall be provided in the locations indicated on the drawings or as indicated in the valve and gate schedules. Operating stands shall support the handwheel approximately 36 inches [900 mm] above the floor. A sleeve made from standard weight galvanized steel pipe shall be provided for the opening in the floor beneath each operating stand. When stems are 10 feet [3 m] or longer, a suitable thrust bearing shall be provided in each operating stand to carry the weight of the extension stem.

2-3.08. Wall Brackets. Wall brackets shall be provided to support manual actuators in the locations indicated on the drawings or in the respective valve schedules. The horizontal face of the bracket shall be predrilled to accept the actuator and the stem without modification. The top of the bracket shall extend sufficiently to bear on and transfer thrust loads to the top of the supporting structure.

2-4. GATE MANUAL ACTUATORS. Not used.

2-5. PROGRAMMABLE ELECTRIC ACTUATORS. Not used.

2-6. STANDARD ELECTRIC ACTUATORS.

2-6.01. General. Standard electric actuators as listed in the valve and gate schedules (specification 11291) shall be provided by the valve or gate manufacturer.

Standard electric actuators for 12 inch [300 mm] and smaller butterfly valves and eccentric plug valves shall be quarter-turn type and shall be Auma "SGBV05" through "SGBV12", EIM "Series P, Q, or R", Limitorque "LY", or Rotork "AQ", without exception.

All other standard electric actuators shall be multiturn type and shall be Auma "SABV07.1" through "SABV48.1", EIM "Series 2000", Limitorque "L120", or Rotork "A Range", without exception.

Standard electric actuators produced by other manufacturers are not acceptable.

Each standard electric actuator shall be furnished complete with a motor, gearing, handwheel, limit switches and torque sensors, lubricants, heating elements, wiring, and terminals. Each actuator shall be constructed as a self-contained unit with a cast iron or aluminum alloy housing, of a type as indicated in the valve and gate schedules, and shall be integrally assembled on the applicable valve or gate by the valve or gate manufacturer.

Actuators shall be designed to cycle the valve or gate from the fully open to the fully closed position or the reverse in approximately 60 seconds or as indicated in the valve and gate schedules.

Actuator motors may be mounted horizontally adjacent to or vertically above the reduction gearing. All gearing shall be oil or grease lubricated.

2-6.02. Motors. Motors shall be totally enclosed, high torque design made expressly for valve actuator service, capable of operating the valve under full differential pressure for two complete strokes or one complete cycle of travel without overheating. Motors shall be designed in accordance with NEMA standards and shall operate successfully at any voltage within 10 percent above or below rated voltage. Motor bearings shall be permanently lubricated.

2-6.03. Power Gearing. Power gearing shall consist of hardened steel spur or helical gears and alloy bronze or hardened steel worm gear, all suitably lubricated, designed for 100 percent overload, and effectively sealed against entrance of foreign matter. Steel gears shall be hardened to at least 350 Brinell. Planetary or cycloidal gearing or aluminum, mild steel, or nonmetallic gears will not be acceptable. Gearing shall be designed to be self-locking so that actuation of a torque switch by a torque overload condition will not allow the actuator to restart until the torque overload has been eliminated. If a secondary gear box is required, it shall be designed to withstand the locked rotor torque of the actuator.

2-6.04. Handwheel Mechanism. The handwheel shall not rotate during motor operation. During handwheel operation the motor shall not affect the actuator operation. The actuator shall be responsive to electrical power and control at all times and, when under electrical control, shall instantly disengage the handwheel. The handwheel shall rotate counterclockwise to open the valve. An arrow indicating the opening direction and the word "Open" shall be cast on the handwheel. The force required to operate the handwheel shall not exceed 80 lbs [350 N]. The handwheel shall have a padlockable declutch lever.

2-6.05. Torque Sensing. Torque and thrust loads in both closing and opening directions shall be limited by a torque sensing device. Each torque sensing device shall be provided with an adjustment setting indicator. The adjustment shall permit a variation of approximately 40 percent in torque setting. Switches shall have a rating of not less than 6 amperes at 120 volts ac and 0.5 ampere at 115 volts dc.

2-6.06. Limit Switches. Each standard electric actuator shall be designed to be readily field adaptable for four limit switch assemblies. Each switch assembly shall consist of at least three separate limit switches, shall be operated by the driving mechanism, and shall be independently adjustable to trip at any point at and between the fully open and fully closed valve positions. All switches shall have an inductive contact rating of not less than 6 amperes at 120 volts ac, 3 amperes at 240 volts ac, 1.5 amperes at 480 volts ac, and 0.5 ampere at 115 volts dc.

Each quarter-turn actuator shall be provided with end-of-travel limit switches in addition to four spdt switches, each independently adjustable at any point of valve travel.

2-6.07. Position Transmitter. When indicated in the valve and gate schedules, actuators shall be provided with an electronic type position transmitter. The transmitter output shall be an isolated 4-20 mA dc capable of driving an external load of 0 to 500 ohms. Accuracy of the transmitted signal shall be ± 2 percent of span. Repeatability and hysteresis shall be within 1 percent. The transmitter shall transmit to a remote position indicator which is specified in the Instrumentation section.

2-6.08. Heating Elements. Space heating elements shall be provided to prevent condensation in the motor and limit switch housing. Heating elements shall be rated 120 volts ac. Heaters shall be continuously energized.

2-6.09. Terminal Facilities. Terminal facilities for connection to motor leads, switches, position transmitter, and heating elements shall be provided in readily accessible terminal compartments. Each terminal compartment shall have at least two openings for external electrical conduits, one sized at least 3/4 inch [19 mm] and the other at least 1-1/4 inches [31 mm]. Each terminal compartment shall be large enough to allow easy routing and termination of fifteen 12 AWG [4 mm²] conductors.

2-6.10. Controller. Each valve or gate shall be furnished with a reversing controller located inside the actuator enclosure and shall have controller devices as indicated in the valve and gate schedules. The controller shall be equipped with:

- a. A motor overload protective device in each phase or solid state motor protection.
- b. A space heater element, rated 120 volts ac, sized to be continuously energized for prevention of condensation within the controller enclosure.
- c. A fused control power circuit taken from one power lead on the load side of the breaker and line side of the reversing starter to ground. If power supply is greater than 120 volts ac, a control power transformer with fused secondary, with volt-ampere capacity suitable for starter control plus continuous service to space heater elements in motor housing, limit switch compartment, and controller enclosure.
- d. A terminal block with connectors for all external controls. All leads from the actuator motor and limit switch assembly shall be routed to terminal connections in the controller for external connections to all other control devices.

- e. Auxiliary control contacts as indicated in the electrical schematics.

Reversing controllers shall be both mechanically and electrically interlocked and shall be provided with the necessary direct-operated auxiliary contacts for required interlocking and control.

Valve controllers shall be expressly selected for long life and reliable, low maintenance service under rugged service conditions.

2-6.11. Control Module. Valves or gates indicated for modulating service in the valve and gate schedules shall be provided with a control module for position modulating type service. The control module shall be mounted within the valve actuator limit switch housing. The module shall accept a standard 4-20 mA dc analog input signal with a load impedance of not greater than 400 ohms. The control module shall contain adjustments for span, zero, gain, and deadband.

The actuator shall have a slide-wire type position feedback potentiometer which provides a position feedback signal to the control module.

2-6.11.01. Control Performance. For any operating torque within the specified range of the valve actuator, the valve and actuator shall perform within these specified limits:

Linearity	Linearity of actual valve position as compared to demand signal shall be within ± 4 percent of span over the entire operating range.
Repeatability	For any repeated demand signal to the valve actuator, the actual valve position shall be repeated.
Deadband	Deadband of the valve actuator shall be adjustable from 1 to 10 percent of span.
Hysteresis	For any repeated demand signal to the valve actuator, from either an increasing or a decreasing direction, the actual valve position shall be repeated within 1 degree of valve shaft rotation.

2-7. HYDRAULIC CYLINDER ACTUATORS. Not used.

2-8. AIR CYLINDER ACTUATORS. Not used.

2-9. AIR-OIL CYLINDER ACTUATORS. Not used.

2-10. PORTABLE ELECTRIC ACTUATORS. Not used.

2-11. PORTABLE HYDRAULIC ACTUATORS. Not used.

2-12. ACTUATOR ACCESSORIES.

2-12.01. Extension Stems. Extension stems and stem guides shall be furnished when indicated in the respective valve schedules, indicated on the drawings, or otherwise required for proper valve operation. Extension stems shall be of solid steel and shall be not smaller in diameter than the stem of the actuator shaft. Extension stems shall be connected to the actuator with a single Lovejoy "Type D" universal joint with grease-filled protective boot. All stem connections shall be pinned.

At least two stem guides shall be furnished with each extension stem, except for buried valves. Stem guides shall be of cast iron, bronze bushed, and adjustable in two directions. Stem guide spacing shall not exceed 100 times the stem diameter or 10 feet [3 m], whichever is smaller. The top stem guide shall be designed to carry the weight of the extension stem. The extension stem shall be provided with a collar pinned to the stem and bearing against the stem thrust guide.

Extension stems for chemical resistant butterfly valves located in drainage sumps shall be the two-piece type with stainless steel stem, PVC housing, wall support, and collar. Unless otherwise indicated on the drawings, the length of the stem extension shall be as necessary to position the valve operator 12 inches above the maximum liquid level in the immediate area.

Extension stems for buried valve actuators shall extend to within 6 inches [150 mm] of the ground surface, shall be centered in the valve box using spacers, and shall be equipped with a wrench nut.

Extension stems for buried valve actuators shall be provided with position indicators as specified in the valve schedules.

2-12.02. Position Indicators. Unless otherwise specified, each valve actuator shall be provided with a position indicator to display the position of the plug or disc relative to the body seat opening.

For quarter turn plug, ball, or cone type valves installed in interior locations, the indicating pointer shall be mounted on the outer end of the valve operating shaft extension and shall operate over an indicating scale on the operating mechanism cover. Where the shaft passes through the cover, a suitable stuffing box or other seal shall be provided to prevent the entrance of water.

Each actuator for butterfly valves, except where located in manholes, buried, or submerged, shall have a valve disc position indicator mounted on the end of the valve shaft. A disc position indicator shall also be provided on each operating stand or the actuator mounted thereon.

2-12.02.01. Position Indicators for Buried Actuators. When specified in the respective valve schedules, each buried valve actuator shall be equipped with a position indicator. Position indicators shall be Indico "Model 179 Valve Position Indicators" manufactured by the Mills Engineering Company, Needham Heights, Massachusetts, or "Diviner" ground level position indicator manufactured by the Henry Pratt Company, Aurora, Illinois. Each indicator assembly shall be designed for installation on the extension stem connected to the operating stem of the buried actuator mechanism and shall be mounted in the top section of the valve box beneath the valve box cover. Each indicator shall be equipped with a wrench nut. Internal gearing shall be sealed and protected from the elements.

2-12.03. Floor Boxes. Openings through concrete slabs provided for key operation of valves shall be provided with a cast iron floor box complete with cover. The floor box shall be of the depth indicated on the drawings. Where the operating nut is in the slab, the stem shall have a guide to maintain the nut in the center of the box; where the nut is below the slab, the opening in the bottom of the box shall accommodate the operating key.

Each floor box and cover shall be shop coated with manufacturer's standard coating.

2-12.04. Torque Tubes. Torque tube shall utilize pipe rather than solid shafting between the valve input shaft and the output shaft of the valve floorstand operator. An adjustment of 2 inches [50 mm] shall be provided in the torque tube installation. Torque tube shall be coated with the same material as the submerged valve.

2-12.05. Valve Boxes. Not used. Each valve buried to a depth of 4 feet [1.2 m] or less shall be provided with a slide type valve box. Valve boxes shall be cast iron, extension sleeve type, suitable for the depth of cover indicated on the drawings. Only one extension will be allowed with each slide type valve box. Valve boxes shall be at least 5 inches [125 mm] in inside diameter, shall be at least 3/16 inch [4.7 mm] thick, and shall be provided with suitable cast iron bases and covers.

Each valve buried deeper than 4 feet [1.2 m] shall be provided with a valve box consisting of a cast iron cover and a 6 inch [150 mm] Cast Iron Pipe section. The cover shall be Clay & Bailey "No. 2193". The pipe shaft shall extend from the valve to 5 inches [125 mm] inside the valve box cover.

All parts of valve boxes, bases, and covers shall be shop coated with manufacturer's standard coating.

Valve boxes which are to be provided with position indicators shall have top sections and covers designed for proper installation of the position indicator and accessories.

2-13. SHOP PAINTING. All ferrous metal surfaces, except bearing and finished surfaces and stainless steel components of valve actuators and accessories, shall be shop painted for corrosion protection. The valve manufacturer's standard coating will be acceptable, provided it is functionally equivalent to the specified coating and is compatible with the specified field painting.

The following surfaces shall be painted:

Polished or Machined Surfaces	Rust-preventive compound.
Other Surfaces	Epoxy enamel.
Actuators and Accessories	Universal primer.

PART 3 - EXECUTION

3-1. INSTALLATION. Actuators will be installed on the valves in accordance with the Valve Installation section and gates in accordance with the Gate Installation section.

3-2. NETWORK SETUP. A manufacturer's representative for the programmable electric actuator manufacturer shall inspect all network terminations for conformity with the manufacturer's recommended methods of terminating the network to each actuator, and shall notify the Contractor of any wiring modifications required. The manufacturer's representative shall also set addresses for each valve and prove communication over the network. The valve manufacturer shall furnish the required information to the control system supplier that will allow the specified control and monitoring for each programmable electric actuator.

The Contractor shall coordinate these activities between the actuator manufacturer and the control system supplier.

End of Section

Section 15400

PLUMBING

PART 1 - GENERAL

1-1. SCOPE. This section covers the furnishing and installation of materials, appliances, fixtures, equipment, and appurtenances associated with the plumbing systems as specified herein and as indicated on the drawings. Additional requirements for plumbing systems shall be as indicated in the schedules on the drawings. Suitable connections shall be provided for each fixture, piece of equipment, and appurtenance.

Pipe materials, valves, thermal insulation, and pipe supports which are not an integral part of the fixture or piece of equipment and are not specified herein are covered in other sections.

1-2. GENERAL. Equipment furnished and installed under this section shall be fabricated, assembled, erected, and placed in proper operating condition in full conformity with the drawings, specifications, engineering data, instructions, and recommendations of the equipment manufacturer unless exceptions are noted by Engineer.

1-2.01. Coordination. Contractor shall verify that each component of the plumbing system is compatible with all other parts of the system; that all piping, fixtures, and appurtenances are appropriate; and that all devices necessary for a properly functioning system have been provided.

Where two or more units of the same class of equipment are required, they shall be the product of a single manufacturer; however, all the component parts of the system need not be the products of one manufacturer.

Where several manufacturers' names have been listed in this section as possible suppliers, only the products of the first manufacturer listed have been checked for size, functions, and features.

1-2.02. General Equipment Stipulations. The General Equipment Stipulations shall apply to all equipment and materials provided under this section. If requirements in this specification differ from those in the General Equipment Stipulations, the requirements specified herein shall take precedence.

1-2.03. Governing Standards. Except as modified or supplemented herein, all work covered by this section shall be performed in accordance with all applicable municipal codes and ordinances, laws, and regulations. In case of a conflict between this section and any state law or local ordinance, the latter shall govern.

All work shall conform to the requirements of AGA, ASTM, NFPA, and UL safety requirements.

1-2.04. Power Supply. Unless otherwise specified, power supply to equipment with motors shall be as indicated on the drawings. Power supply for controls shall be 120 volts, 60 Hz, single phase unless otherwise required for a properly operating system.

1-2.05. Metal Thickness. Metal thicknesses and gages specified herein are minimum requirements. Gages refer to US Standard gage.

1-3. MECHANICAL IDENTIFICATION.

1-3.01. Number Plates. All plumbing equipment, piping, and valves denoted on the drawings by a symbol and an identifying number shall be provided with an identifying number plate. The identifying text shall be identical to the symbols indicated herein or on the drawings and shall be located in a conspicuous place. Number plate symbols and numbers shall be capitalized block letters with a minimum height as indicated below.

<u>Item Identified</u>	<u>Letter Height, inches [mm]</u>
Major Equipment	3/4 [19]
Minor Equipment	1/2 [13]

Number plate height shall be twice the letter height. Number plate length shall be as needed, with suitable margins all around. Lettering shall be placed in one row where practicable; however, where required due to excessive length, lettering shall be placed on more than one row and centered.

Number plates shall be in the form of nameplates unless equipment is too small to accommodate the specified nameplate, then tags shall be used. Nameplates and tags shall be metal or plastic. Plastic nameplates and tags shall be laminated phenolic not less than 1/8 inch [3 mm] thick and shall be black with a white core. Metal nameplates and tags shall be at least 12 gage [2.66 mm] thickness with engraved or imprinted symbols. Tags shall have smooth edges and shall be a minimum diameter of 1-1/2 inches [38 mm]. Tags shall be installed with corrosion-resistant chains or straps. Nameplates shall be installed with corrosion-resistant mechanical fasteners.

1-3.02. Equipment Plates. Plumbing equipment shall be identified with engraved or stamped equipment plates securely affixed to the equipment in an accessible and visible location. Equipment plates shall be in addition to the number plates specified in the preceding paragraph. Equipment plates shall indicate the manufacturer's name, address, product name, catalog number, serial number, capacity, operating and power characteristics, labels of tested compliances, and any other pertinent design data. Equipment plates listing the distributing agent only will not be acceptable.

1-3.03. Piping. Piping identification shall be as specified in the protective coatings section.

1-3.04. Valves. Valves that have been assigned an identification number shall be identified with tags.

1-4. SUBMITTALS.

1-4.01. Drawings and Data. Complete assembly and installation drawings, and wiring and schematic diagrams, together with detailed specifications and data covering materials, parts, devices, and accessories forming a part of the equipment furnished, shall be submitted in accordance with the submittals section. Device tag numbers indicated on the drawings shall be referenced on the wiring and schematic diagrams where applicable. The data and specifications to be submitted for each unit shall include, but shall not be limited to, the following:

Equipment, Piping Accessories, and Appurtenances

Name of manufacturer.

Type and model.

Construction materials, thicknesses, and finishes.

Capacities.

Pressure and temperature ratings.

Overall dimensions.

Piping connection sizes and locations.

Net weight.

Horsepower [kW].

Power requirements.

Wiring diagrams.

Plumbing Fixtures

Name of manufacturer.

Type and model.

Construction materials, thicknesses, and finishes.

Water consumption data.

Overall dimensions.

Rough-in dimensions.

Piping connection sizes and locations.

Net weight.

1-4.02. Operations and Maintenance Data and Manuals. Not used.

1-5. QUALITY ASSURANCE.

1-5.01. Welding Qualifications. All welding procedures and welding operators shall be qualified by an independent testing laboratory in accordance with the applicable provisions of AWS Standard Qualification Procedures. All procedure and operator qualifications shall be in written form and subject to Engineer's review. Accurate records

of operator and procedure qualifications shall be maintained by Contractor and made available to Engineer upon request.

1-5.02. Qualification. The plumbing system installer shall be licensed as stipulated by the authority having jurisdiction.

1-5.03. Manufacturer's Experience. Unless the equipment manufacturer is specifically named in this section, the manufacturer shall have furnished equipment of the type and size specified which has been in successful operation for not less than the past 5 years.

1-5.04. Construction. Not used. Plumbing fixtures shall be constructed in accordance with the following standards:

Enameled Cast Iron	ANSI/ASME A112.19.1M
Vitreous China	ANSI/ASME A112.19.2M
Stainless Steel	ANSI/ASME A112.19.3M
Faucets	ANSI/NSF 61
Emergency/Safety Fixtures	ANSI Z358.1

Electric water coolers shall be UL listed and certified in accordance with the Air Conditioning and Refrigeration Institute (ARI) Standard 1010. All materials in contact with water shall comply with the Safe Drinking Water Act of 1986, and the Lead Contamination Control Act of 1988.

1-6. DELIVERY, STORAGE, AND HANDLING. Shipping shall be in accordance with the shipping section. Handling and storage shall be in accordance with the Handling and Storage section.

1-7. EXTRA MATERIALS. Not used.

PART 2 - PRODUCTS

2-1. SERVICE CONDITIONS. All plumbing fixtures and equipment shall be designed and selected to meet the specified conditions.

2-2. PERFORMANCE AND DESIGN REQUIREMENTS. All fixtures and equipment shall be designed to meet the performance and design conditions specified herein and indicated on the drawings.

2-2.01. Dimensional Restrictions. Layout dimensions will vary between manufacturers and the layout area indicated on the drawings is based on typical values. Contractor shall review the contract drawings, the manufacturer's layout drawings, and installation

requirements and shall make any modifications required for proper installation subject to acceptance by Engineer.

2-3. ACCEPTABLE MANUFACTURERS. Acceptable manufacturers shall be as listed in the respective product description paragraphs.

2-4. MANUFACTURE AND FABRICATION.

2-4.01. Anchor Bolts and Expansion Anchors. Anchor bolts, expansion anchors, nuts, and washers shall be as indicated in the anchorage in concrete and masonry section unless otherwise indicated on the drawings.

2-4.02. Surface Preparation. All iron and steel surfaces, except motors and speed reducers, shall be shop cleaned by sandblasting or equivalent, in strict conformance with the paint manufacturer's recommendations. All mill scale, rust, and contaminants shall be removed before shop primer is applied.

2-4.03. Shop Painting. All steel and iron surfaces shall be protected by suitable coatings applied in the shop. Surfaces which will be inaccessible after assembly shall be protected for the life of the equipment. Coatings shall be suitable for the environment where the equipment is installed. Exposed surfaces shall be finished, thoroughly cleaned, and filled as necessary to provide a smooth, uniform base for painting. Electric motors, speed reducers, starters, and other self-contained or enclosed components shall be shop primed or finished with an oil-resistant enamel or universal type primer suitable for top coating in the field with a universal primer and aliphatic polyurethane system.

Surfaces to be coated after installation shall be prepared for painting as recommended by the paint manufacturer for the intended service, and then shop painted with one or more coats of the specified primer.

Surface finish damaged during installation shall be repaired to the satisfaction of Engineer. Field painting shall conform to the requirements of the painting section.

2-4.04. Equipment Bases. Not used.

2-4.05. Special Tools and Accessories. Equipment requiring periodic repair and adjustment shall be furnished complete with all special tools, instruments, and accessories required for proper maintenance. Equipment requiring special devices for lifting or handling shall be furnished complete with those devices.

2-4.06. Piping Systems. Unless otherwise specified herein, piping system materials shall be as specified in other sections.

2-4.07. Valves. Unless otherwise specified herein, valves indicated to be a part of the plumbing systems shall be as specified in other sections.

2-5. WATER SUPPLY PIPING ACCESSORIES.

2-5.01. Water Hammer Arresters. Not used.

2-5.02. Trap Primers. Not used.

2-5.03. Thermostatic Mixing Valves. Not used.

2-5.04. Vacuum Relief Valves. Not used.

2-5.05. Thermometers. Not used.

2-5.06. Strainers. Not used.

2-5.07. Hose Faucets. Not used. Hose faucets shall be constructed with nickel or chrome plated cast brass body, solid brass stem, threaded bonnet, and "T" style handle. Hose faucets shall be provided with a 3/4 inch male pipe thread inlet and a 3/4 inch male hose thread outlet unless otherwise indicated on the drawings. Hose faucets shall be Prier Brass "Model C-138NP.75" or Arrowhead Brass Products.

2-5.08. Hose Valves. Not used.

2-5.09. Wall Hydrants. Not used.

2-5.10. Pressure Gauges. Not used.

2-6. DRAINAGE AND VENT PIPING ACCESSORIES.

2-6.01. Cleanouts. Not used. Cleanouts shall be provided where indicated on the drawings and required by the referenced codes, and shall be of the required type.

Floor cleanouts shall consist of a two piece body, a threaded plug, an adjustable head, and a cover. Cleanouts installed in floors that include a waterproofing membrane shall be provided with a flashing flange and membrane clamp. Cleanouts installed in partition walls shall be provided with an access cover and frame with a securing screw installed over the cleanout plug. Wall cleanout covers shall be stainless steel. Cleanouts installed in exposed piping shall consist of a ferrule or threaded adapter and a cast brass or bronze plug installed in a T-pattern, 90 degree drainage fitting.

Cast iron cleanouts shall be manufactured by Smith, Josam, or Wade. Polypropylene cleanouts shall be manufactured by Orion or Enfield. PVC cleanouts shall be manufactured by Sioux Chief.

2-6.02. Bell-Up Drains. Not used.

2-6.03. Funnel Receptors. Funnel receptors shall consist of cast iron funnels with cast iron dome type bottom strainers. Funnel receptors shall be provided with waterstop flange and threaded or no-hub outlet connections suitable for connection to the waste piping. Funnel receptors shall be furnished with a factory applied chemical resistant interior coating. Unless otherwise indicated, funnel receptors shall be installed 1 inch [25 mm] above the finished floor.

Funnel receptors shall be Smith "Series 3800 Figure SQ-3-1793-DBS", Josam, or Wade.

2-7. PLUMBING FIXTURES AND ACCESSORIES. Not used.

2-8. PLUMBING EQUIPMENT. Not used.

2-8.01. General. Plumbing equipment shall be provided with all supports, fasteners, fittings, and escutcheons required for a complete installation.

2-8.02. Water Heaters and Accessories. Not used.

2-8.03. Neutralization Tanks. Not used.

2-8.04. Hose Reels. Not used.

2-8.05. Hoses. Hose type, diameter, manufacturer, and model shall be as indicated on the drawings.

Unless otherwise indicated, each hose shall be provided with one male swivel type brass hose connector, one female brass hose connector, and one regulating wash-up spray nozzle. Spray nozzles in 1 inch [25 mm] and 1-1/2 inch [38 mm] sizes shall be Potter-Roemer Inc. "Series 2970" with a cast brass body, a rubber bumper, and a female hose thread.

2-8.05.01. Type 1 Hoses. Not used.

2-8.05.02. Type 2 Hoses. Not used.

2-8.05.03. Type 3 Hoses. Not used.

2-8.05.04. Type 4 Hoses. Type 4 hoses shall be suitable for lay flat water discharge service and shall be rated for 75 psig [500 kPa gauge] working pressure. The hose shall be 1-1/2 inch [38 mm] ID with a heavy-duty polyvinyl chloride (PVC) body and synthetic, high tensile textile cord reinforcement. Type 4 hoses shall be Gates Rubber Company "Masterflex 500".

2-9. COLOR. Plumbing equipment shall have the manufacturer's standard color and finish unless otherwise indicated in the schedules.

2-10. ELECTRICAL. Electrical controls and disconnects shall be furnished and installed under the electrical section, except where specified herein. All electrical controls shall have enclosures suitable for the environment and NEMA rating as indicated on the electrical drawings.

PART 3 - EXECUTION

3-1. INSPECTION. Equipment installed in existing facilities with limited access shall be suitable for being installed through available openings. Contractor shall field verify existing opening dimensions and other provisions for installation prior to submittal of bids.

3-2. PREPARATION.

3-2.01. Surface Preparation. All surfaces to be field painted shall be dry and free of dirt, dust, sand, grit mud, oil, grease, rust, loose mill scale, or other objectionable substances, and shall meet the recommendations of the paint manufacturer for surface preparation. Cleaning and painting operations shall be performed in a manner which will prevent dust or other contaminants from getting on freshly painted surfaces. Oil and grease shall be completely removed by use of solvents or detergents before mechanical cleaning is started. The gloss of previously painted surfaces shall be dulled if necessary for proper adhesion of top coats.

3-3. INSTALLATION. Materials furnished under this section shall be installed in proper operating condition in full conformity with the drawings, specifications, engineering data, instructions, and recommendations of the equipment manufacturer, unless exceptions are noted by Engineer.

Unless otherwise indicated, sleeves shall be provided for all pipe penetrations through concrete and masonry walls. Sleeves and sealing requirements shall be as indicated in the miscellaneous piping and accessories installation section and as indicated on the drawings.

Not all required reducing fittings and unions are indicated. Additional fittings and unions shall be provided as needed to connect all equipment and appurtenances.

Insulating fittings shall be provided to prevent the contact of dissimilar metals in piping systems.

When located indoors, fuel gas pressure regulator vents and fuel train vent valves shall be piped to the exterior of the building in accordance with the applicable codes and standards.

Piping shall not be routed over or in front of electrical switchboards or panels unless acceptable to Engineer.

3-3.01. Water Supply Piping and Accessories. Water hammer arresters shall be provided in the hot and cold water supply piping at all quick closing valves, at solenoid valves, and at plumbing fixtures. When not indicated on the drawings, arresters shall be located and sized by Contractor in accordance with PDI Standard No. WH201. Contractor shall submit arrester location and sizing plans to Engineer for approval prior to installation. Where possible, water hammer arresters shall be installed in an accessible location.

Water supply piping to hose faucets and hose valves shall be secured with a pipe support within 6 inches [150 mm] of the fixture.

3-3.02. Drainage and Vent Piping and Accessories. Unless otherwise indicated or required by code, horizontal sanitary drainage piping 3 inches [75 mm] in diameter or smaller shall be installed at a uniform slope of 1/4 inch per foot [2 percent]; horizontal sanitary drainage piping larger than 3 inches [75 mm] in diameter shall be installed at a uniform slope of 1/8 inch per foot [3 mm/300 mm]; horizontal storm drainage piping shall be installed at a uniform slope of 1/8 inch per foot [3 mm/300 mm].

Drainage fittings shall be installed to convey flow in the piping in the intended direction. To the extent possible, changes in direction shall be made by sweep type fittings. Quarter-bends and sanitary tee fittings shall not be installed for vertical to horizontal or horizontal to horizontal changes of direction.

Plumbing vents through roofs shall be located at least 12 inches [300 mm] from a parapet or from the intersection of a cant with the roof deck, and shall be installed with watertight flashings. Plumbing vents shall be located no closer to operable windows or air intakes than is allowed by the applicable code.

Vents connecting to horizontal sanitary piping shall connect above the centerline of the piping and shall rise at an angle of not less than 45 degrees from the horizontal to a point at least 6 inches [150 mm] above the flood level rim of the fixture served before offsetting horizontally.

Cleanouts on drainage piping inside structures shall be located where indicated on the drawings. Additional cleanouts shall be provided where required by the applicable code or authority having jurisdiction. Cleanouts located in drainage risers shall be located 12 inches [300 mm] above the finished floor.

Unless otherwise indicated or required by the applicable code, cleanout size shall equal the line size for 4 inch [100 mm] and smaller drainage piping, and 4 inches [100 mm] in diameter for drains larger than 4 inch [100 mm]. Proper clearance shall be provided for access to cleanouts. Floor cleanouts shall be installed flush with the finished floor.

Floor drains, trench drains, floor sinks, funnel receptors, and bell-up drains indicated to be equipped with traps shall be provided with deep seal "P" traps located as close to the drain as possible.

3-3.03. Plumbing Fixtures and Accessories. Not used.

3-4. FIELD QUALITY CONTROL.

3-4.01. Installation Check. An installation check by an authorized representative of the manufacturer of equipment specified herein is not required.

3-4.02. Startup and Testing. Field performance tests shall be conducted to demonstrate that each system is functioning as specified and to the satisfaction of Engineer.

If inspection or tests indicate defects, the defective work or material shall be replaced, and inspection and tests repeated. All repairs to piping shall be made with new materials. Caulking of threaded joints or holes will not be acceptable.

3-5. ADJUSTING. All devices shall be adjusted for proper flow and quiet operation. Faucet and supply assemblies shall be adjusted or repaired to eliminate leaks. All drains shall be checked for proper operation.

3-6. PROTECTION. Plumbing fixtures, equipment and appurtenances shall be protected from damage immediately after installation.

3-7. CLEANING. After completion of testing and immediately before the final inspection, plumbing fixtures, equipment, piping, and appurtenances shall be thoroughly cleaned. Cleaning materials and methods shall be as recommended by the manufacturer. All faucet aerators shall be removed, cleaned, and reinserted.

Any stoppage, discoloration, or other damage to parts of the building, its finish, or furnishings shall be repaired at no additional cost to Owner.

3-8. DISINFECTION. Not used.

3-9. OPERATOR INSTRUCTION AND TRAINING. Not used.

End of Section

Section 15500

HEATING, VENTILATING, AND AIR CONDITIONING

PART 1 - GENERAL

1-1. SCOPE. This section covers the furnishing and installation of heating, ventilating, and air conditioning (HVAC) equipment, devices, and appurtenances associated with the HVAC systems.

Piping, pipe supports, valves, and accessories which are not an integral part of the equipment or are not specified herein are covered in other sections.

1-2. GENERAL. Equipment furnished and installed under this section shall be fabricated, assembled, erected, and placed in proper operating condition in full conformity with the drawings, specifications, engineering data, instructions, and recommendations of the equipment manufacturer unless exceptions are noted by Engineer.

1-2.01. Coordination. Contractor shall verify that each component of the system is compatible with all other parts of the system; that all piping, ductwork, materials, fans, and motor sizes are appropriate; and that all devices necessary for a properly functioning system have been provided.

Where two or more units of the same class of equipment are needed, they shall be the product of a single manufacturer; however, all the component parts of the system need not be the products of one manufacturer.

Where individual equipment paragraphs specify the requirement for local service, each manufacturer shall have a local service center, or with written consent of Engineer, shall be able to provide service from other locations within 24 hours. The service center shall be equipped and staffed to service the system and shall maintain a local parts supply. Information on equipment manufacturers' representatives shall be included with the submittals.

Where several manufacturers' names have been listed in this section as possible suppliers, only the products of the first manufacturer listed have been checked for size, functions, and features.

1-2.02. General Equipment Stipulations. The General Equipment Stipulations shall apply to all equipment and materials furnished under this section. If requirements in this specification differ from those in the General Equipment Stipulations, the requirements specified herein shall take precedence.

1-2.03. Governing Standards. Except as modified or supplemented herein, all work covered by this section shall be performed in accordance with all applicable municipal codes and ordinances, laws, and regulations. In case of a conflict between this section and any state law or local ordinance, the latter shall govern.

All work shall comply with UL safety requirements.

1-2.04. Power Supply. Power supply to equipment with motors shall be as indicated in schedules on the drawings. Power supply for controls shall be 120 volts, 60 Hz, single phase unless otherwise required for a properly operating system.

1-2.05. Metal Thickness. Metal thickness and gages specified herein are minimum requirements. Gages refer to US Standard gage.

1-2.06. Mechanical Identification. Mechanical identification shall conform to the requirements of the Basic Mechanical Building Systems Materials and Methods section.

1-3. SUBMITTALS.

1-3.01. Drawings and Data. Complete assembly and installation drawings, and wiring and schematic diagrams, together with detailed specifications and data covering materials, parts, devices, and accessories forming a part of the equipment furnished, shall be submitted in accordance with the Submittals section. Device tag numbers indicated on the drawings shall be referenced on the wiring and schematic diagrams where applicable. The data and specifications for each unit shall include, but shall not be limited to, the following:

Room Air Conditioners

- Name of manufacturer.
- Type and model.
- Construction materials, thickness, and finishes.
- Certified performance data and ratings.
- Capacity at specified conditions.
- Overall dimensions and required clearances.
- Wiring diagrams and electrical requirements.
- Net weight.
- Where specified, information on equipment manufacturers' representatives.

Equipment (not specifically listed)

- Name of manufacturer.
- Type and model.
- Construction materials, thickness, and finishes.
- Manufacturer's performance data.
- Overall dimensions and required clearances.
- Net weight and load distribution.
- Wiring diagrams.

Sheet Metal Ductwork

- Sheet metal duct fabrication drawings indicating dimensions of individual shop and field fabricated sections, top and/or bottom duct elevations, joint locations, and dimensions of duct from walls or column rows.
- Pressure and seal classifications.
- Reinforcement types and spacing.
- Joint and seam types.
- Hanger and support types, spacing, and attachment methods.
- Access panel and door construction, sizes, and locations.

Duct sealant, adhesive, gasket, and tape information.

Coatings.

Ductwork materials and thicknesses.

Temperature Controls

Published descriptive data on each item of equipment and accessories, indicating all specific characteristics and options and identified with the designation used herein and on the drawings.

Schematic control diagrams giving specific data on all settings, ranges, actions, adjustments, and normal positions. Although schematic, these diagrams shall, as closely as possible, represent the actual system with all significant equipment and devices identified and located relative to each other. These diagrams shall also show detailed multiline wiring with all terminals accurately identified. The wiring diagrams shall show the internal connections of the temperature control panels and all field wiring to equipment remote from the control panels, including wiring to Owner-furnished equipment. The wiring diagrams shall be complete, showing all connections necessary to place the temperature control systems in operation. Wiring diagrams shall be detailed to the degree necessary for field construction and shall include all related wiring.

Sequence of operation for each system corresponding to the control schematics.

Space thermostat schedule indicating the types of covers and means of adjustment for each space.

Conduit and wire types.

Where specified, information on equipment manufacturers' representatives.

1-3.02. Operation and Maintenance Data and Manuals. Adequate operation and maintenance information shall be supplied as required in the Submittals section. Operation and maintenance manuals shall be submitted in accordance with the Submittals section. The operation and maintenance manuals shall be in addition to any instructions or parts lists packed with or attached to the equipment when delivered.

In addition to the requirements of the Submittals section, the operation and maintenance manuals shall include a listing of all filter locations, types, sizes, and quantities associated with each piece of equipment.

1-4. QUALITY ASSURANCE. Quality assurance shall comply with the requirements of the Basic Mechanical Building Systems Materials and Methods section.

1-5. DELIVERY, STORAGE, AND HANDLING. Shipping shall be in accordance with the Shipping section. Handling and Storage shall be in accordance with the Handling and Storage section.

1-6. EXTRA MATERIALS. Extra materials shall be furnished for the equipment as specified in the individual equipment paragraphs.

Extra materials shall be packaged in accordance with the Shipping section, with labels indicating the contents of each package. Each label shall indicate manufacturer's name, equipment name,

equipment designation, part nomenclature, part number, address of nearest distributor, and current list price. Extra materials shall be delivered to Owner as directed.

Extra materials subject to deterioration such as ferrous metal items and electrical components shall be properly protected by lubricants or desiccants and encapsulated in hermetically sealed plastic wrapping.

PART 2 - PRODUCTS

2-1. SERVICE CONDITIONS. All equipment shall be designed and selected to meet the specified conditions.

2-2. PERFORMANCE AND DESIGN REQUIREMENTS. Equipment and coil capacities shall be as indicated on the schedules. Where equipment is provided with protective coatings, unit capacities shall be corrected to account for any efficiency losses from the selected protective coating.

Each fan's operating selection point on the fan curves shall be selected to the right of the peak pressure/efficiency point and below the lowest point along the fan curve to the left of the peak pressure/efficiency point.

2-2.01. Dimensional Restrictions. Layout dimensions will vary between manufacturers and the layout area indicated on the drawings is based on typical values of the first manufacturer listed. Contractor shall review the contract drawings, the manufacturer's layout drawings, and installation requirements and shall make any modifications required for proper installation subject to acceptance by Engineer. At least 3 feet [0.9 m] of clear access space shall be provided on all sides of the unit unless otherwise indicated.

2-2.02. Elevation. Equipment shall be designed to operate at the elevation as indicated on the drawings.

2-3. ACCEPTABLE MANUFACTURERS. Acceptable manufacturers shall be as listed in the respective product description paragraphs.

2-4. MATERIALS.

2-4.01. Gas Vent Systems. Not used.

2-4.02. Room Air Conditioning Units. A room air conditioner denoted by the symbol "RAC" and an identifying number, shall be furnished and installed where indicated on the drawings. The unit manufacturer and model number shall be Marvair model "AVP".

The unit shall be complete with scroll compressor, evaporator coil, condenser coil, fan motor, evaporator blower and condensing fan, air filters, drain pan, lead/lag microprocessor thermostat, and all other necessary operating and safety controls. All copper and other surfaces subject to corrosion from the hydrogen sulfide atmosphere shall be given a protective coating. The slide-out chassis shall be mounted in a heavy gauge galvanized steel cabinet. The unit shall provide

positive exhaust and ventilation and shall have an easily removable filter. The unit shall be designed to operate on the power supply as indicated on the drawings.

2-4.02.01. Controls. Each packaged unit shall be completely factory wired with a single point power connection and factory installed integral disconnect switch. Where a factory installed integral disconnect switch is not available as a standard option, a disconnect switch for field installation on the unit shall be provided. All wiring shall be installed in accordance with the National Electrical Code.

A thermostat for operation of both packaged units shall be furnished and installed as indicated on the Drawings. The thermostat shall be a microprocessor controller with programmable heating and cooling set points, and programmable lead/lag control designed to operate a fully or partially redundant heating and cooling system. The number of stages shall be suitable for the unit control and operation. The thermostat shall have a range of approximately 50 to 90°F [10 to 32°C] with at least a 5°F [3°C] deadband between heating and cooling. The thermostat shall have the following features:

7 day programming with 2 occupied/unoccupied periods per day.

Programmable lead/lag changeover in ½ to 7 day increments

Automatic heat/cool changeover.

Battery backup.

Digital display.

Temporary override of setpoints.

Configurable LED's.

2-4.03. Furnaces. Not used.

2-4.04. Makeup Air Units. Not used.

2-4.05. Heaters. Not used.

2-4.06. Fans. Not used.

2-4.07. Roof Hoods. Not used.

2-4.08. Dampers. Not used.

2-4.09. Damper Operators. Not used.

2-4.10. Air Outlet and Inlet Devices. Air outlet and inlet devices shall be manufactured by Titus, Tuttle & Bailey, or Price. Air outlet and inlet devices shall be furnished and installed where indicated on the drawings.

Where air outlet and inlet devices are installed in ductwork given a protective coating, an identical coating shall be applied to the air outlet and inlet devices.

2-4.10.01. Ceiling Diffusers. Not used.

2-4.10.02. Registers and Grilles. Registers and grilles shall be constructed of aluminum or steel as indicated in the schedules on the drawings. The front blades of adjustable blade models shall be parallel to the short dimension unless otherwise indicated, and the front blades of fixed blade models shall be horizontal unless otherwise indicated. All registers shall be furnished with key-operated opposed blade dampers. The dampers shall be constructed of the same material as the attached grille.

2-4.11. Flexible Connections. Not used.

2-4.12. Air Filtration Equipment.

2-4.12.01. Pleated Air Filters. Not used.

2-4.13. Draft Gauges. Not used.

2-4.14. Sheet Metal Ductwork. Ductwork, accessories, bracing, and supports shall be constructed of galvanized steel. Ductwork, turning vanes, and other accessories shall be fabricated in accordance with the latest SMACNA HVAC Duct Construction Standards. Accessories, bracing, and supports shall be constructed of similar materials as the ductwork.

Galvanized ductwork located in air conditioned spaces shall be constructed of G-60 or better lockforming quality in accordance with ASTM A653. All welds on galvanized metal shall be cleaned and coated with a zinc-rich paint.

Sealants shall be suitable for the duct service and shall maintain leakage integrity at pressures in excess of the ductwork pressure classification.

Where indicated on the drawings, ductwork and accessories shall be given a protective coating resistant to the corrosive atmosphere indicated.

2-4.15. Duct Insulation. Interior duct liner shall be Knauf "Duct Liner E M", CertainTeed "ToughGard R", or Johns Manville "Permacote-Linacoustic".

Interior duct liner shall be 1-1/2 pound per cubic foot [24 kg/m^3] density, spray coated duct liner with an "R" value of at least $4.2 \text{ ft}^2 \text{ hr F/BTU}$ [$0.74 \text{ m}^2 \text{ }^\circ\text{C/W}$] per inch [25 mm] thickness. The insulation shall be suitable for temperatures up to 250°F [121°C] and shall have at least a 0.55 NRC per 1 inch [25 mm] thickness. The insulation shall conform to ASTM C1071.

2-4.16. Flexible Duct and Takeoffs. Not used.

2-4.17. Access Doors. Not used.

2-4.18. Temperature Controls. The temperature control components and systems shall be manufactured by Honeywell; Johnson Controls; or Siemens Building Technologies, Landis Division. Where manufacturers are not specified, materials and equipment furnished shall meet the performance and design requirements indicated

The manufacturer of the equipment provided shall have a local service center.

2-4.18.01. Performance and Design Requirements. Contractor shall coordinate with the Work to make certain that the field wiring associated with the work of this section is completed in accordance with the requirements of the heating, ventilating, and air conditioning equipment furnished and their interconnection. Where cable and conduit is not indicated on the drawings but is needed for a complete and functional control system in accordance with the sequence of operation it shall be provided as specified herein. The control wiring shall be installed so that all HVAC equipment will function as described in the HVAC sequence of operation.

Conduit and control wiring for all control circuits needed between all field mounted HVAC controlling and indicating devices, such as, but not limited to, damper actuators, thermostats, temperature control panels, pressure differential switches, control switches, motor starters, and the HVAC equipment, shall be furnished and installed as specified in the Electrical Wiring paragraph. Cable and conduit for all HVAC power circuits shall be as specified in the Electrical section.

2-4.18.02. Tolerances. Unless otherwise indicated, the controls shall maintain space temperatures within $\pm 2^{\circ}\text{F}$ [1.1°C], and the relative humidity within ± 5 percent of the setpoint.

2-4.18.03. Thermostats. Where indicated on the drawings, thermostats shall be constructed of materials resistant to or shall be protected from the corrosive atmosphere indicated. Thermostats specified in the individual equipment paragraphs shall be provided with the respective equipment.

- a. Two Position Wall Mounted Thermostats. Two position wall mounted thermostats shall be Honeywell "T631A Airswitch", Penn Controls "A19BAC-1", or Siemens Building Technologies.

Two position wall mounted thermostats shall be line voltage type. The thermostats shall have a range of approximately 35°F to 100°F [2°C to 38°C] with a nonadjustable differential of 3.5°F [2°C]. The thermostats shall have a spdt switch rated for 1 horsepower [0.746 kW].
- b. Low Limit Thermostats. Not used.
- c. Modulating Duct Mounted Thermostats. Not used.
- d. Explosion-proof Thermostats. Not used.

2-4.18.04. Temperature Control Panels. Not used.

2-4.18.05. Dial Thermometers. Not used.

2-4.18.06. Smoke Detectors. Not used.

2-4.18.07. Pressure Differential Airflow Switches. Not used.

2-4.18.08. Control Stations. Not used.

2-4.18.09. Emergency Ventilation Shutoff Switches. Not used.

2-4.18.10. Accessory Components. All additional control components, including, but not limited to, electric relays, temperature sensors and transmitters, humidity sensors and transmitters, controllers, and position switches, shall be furnished where necessary to ensure a complete, properly operating installation. All components shall be products of the temperature control manufacturer. Accessory components not mounted inside the temperature control panels shall be furnished with equipment enclosures. Relays shall be provided with 120 volt coils and at least 10 ampere contacts.

2-4.18.11. Electrical Wiring. Detailed wiring diagrams shall be submitted in accordance with the Submittals section. The wiring diagrams shall show the internal connections of the control panels and all field wiring to equipment remote from the control panels including wiring to Owner-furnished equipment. The wiring diagrams shall be complete, showing all connections necessary to place the temperature control systems in operation.

Control wiring shall be in accordance with the National Electric Code (NEC). Cable shall be multi-conductor, at least 18 AWG size, specifically designed for industrial systems and UL listed for indoor/outdoor installations.

Conduit for all HVAC control circuits in exposed indoor locations shall be rigid steel or intermediate metal, except in areas designated on the electrical drawings as Area Type 1A. Exposed conduit shall be rigidly supported by hot-dip galvanized hardware and framing materials, including nuts and bolts. In areas designated Type 1A, exposed conduit shall be rigid Schedule 40 PVC non-metallic conduit with PVC fittings, boxes, and accessories. Conduit installed in floor slabs and walls in non-hazardous (classified) locations shall be rigid Schedule 40 PVC. All conduit and conduit installation shall be in accordance with the requirements of the Electrical section and NEC.

2-5. ELECTRICAL. Electric motors and motor controls shall conform to the Basic Mechanical Building Systems Materials and Methods section. Motor starters and controls shall be furnished and installed under the Electrical section, except for equipment specified or furnished with prewired integral starters. Disconnects for equipment shall be furnished and installed under the Electrical section, except where specified with integral disconnects. All electrical controls shall have enclosures suitable for the environment and NEMA rating as indicated on the electrical drawings. Equipment installed outdoors shall have NEMA Type 4 enclosures.

2-6. DRIVE UNITS. Electric motors, V-belt drives, and safety guards shall be in accordance with the requirements of the Basic Mechanical Building Systems Materials and Methods section.

2-7. MANUFACTURE AND FABRICATION. Manufacture and fabrication shall comply with the requirements of the Basic Mechanical Systems Materials and Methods section.

2-8. SHOP TESTING. The equipment furnished under this section shall be tested at the factory according to the standard practice of the manufacturer. Ratings shall be based on tests made in accordance with applicable AMCA, ASHRAE, ARI, NBS, NFPA, and UL Standards.

2-9. BALANCE. All rotating parts shall be accurately machined and shall be in as nearly perfect rotational balance as practicable. Excessive vibration shall be sufficient cause for rejection of the equipment. The mass of the unit and its distribution shall be such that the resonance at normal operating speeds is avoided. In any case, the maximum measured root-mean-square (rms) value as measured at any point on the equipment shall not exceed those listed in the latest ASHRAE Applications Handbook.

At any operating speed, the ratio of rotative speed to the critical speed of a unit or components thereof shall be less than 0.8 or more than 1.3.

PART 3 - EXECUTION

3-1. INSPECTION. Equipment installed in facilities with limited access shall be suitable for being installed through available openings. Contractor shall field verify existing opening dimensions and other provisions for installation prior to submittal of bids.

Where penetrations through existing concrete slabs are made, the Contractor shall locate and avoid damage to all rebar, embedded conduit, etc. when making new openings.

3-2. PREPARATION.

3-2.01. Field Measurement. Contractor shall be responsible for verifying all field dimensions, and for verifying location of all equipment relative to any existing equipment or structures.

3-2.02. Surface Preparation. All surfaces to be field painted shall be dry and free of dirt, dust, sand, grit, mud, oil, grease, rust, loose mill scale, or other objectionable substances, and shall meet the recommendations of the paint manufacturer for surface preparation. Cleaning and painting operations shall be performed in a manner which will protect freshly painted surfaces from dust or other contaminants. Oil and grease shall be completely removed by use of solvents or detergents before mechanical cleaning is started. The gloss of previously painted surfaces shall be dulled if necessary for proper adhesion of top coats.

Surface finish damaged during installation shall be repaired to the satisfaction of Engineer. Field painting shall be as specified in the architectural painting and Protective Coatings sections.

3-3. INSTALLATION. Equipment and materials furnished under this section shall be installed in proper operating condition in full conformity with the drawings, specifications, engineering data, instructions, and recommendations of the equipment manufacturer, unless exceptions are noted by Engineer.

3-3.01. Gas Vents. Not used.

3-3.02. Room Air Conditioning Units. Room air conditioners shall be installed in accordance with the manufacturer's installation instructions. Each unit shall be leveled and installed to maintain the recommended clearances. The units shall be firmly anchored to the structure wall with corrosion resistant fasteners.

The installation shall be checked by the manufacturer in accordance with the Installation Check paragraph.

3-3.03. Furnaces. Not used.

3-3.04. Makeup Air Units. Not used.

3-3.05. Heaters. Not used.

3-3.06. Fans. Not used.

3-3.07. Roof Hoods. Not used.

3-3.08. Damper Operators. Not used.

3-3.09. Air Outlet and Inlet Devices. Air outlet and inlet devices shall be installed level and plumb and in accordance with the manufacturer's written instructions.

3-3.10. Draft Gauges. Not used.

3-3.11. Sheet Metal Ductwork. Ductwork, turning vanes, and other accessories shall be installed and supported in accordance with the latest SMACNA Duct Construction Standards. The locations, arrangement, and sizes of ductwork shall be as indicated on the drawings. The duct sizes indicated are clear dimensions inside the duct or duct lining. Sheet metal sizes are larger for ductwork with interior linings.

Ductwork shall be fabricated, reinforced, supported, and sealed for the operating pressures indicated in the schedules for the connected equipment. All ductwork shall have a pressure classification of at least 1 inch [25 mm].

Sheet metal ductwork shall be sealed according to the classifications described in the SMACNA HVAC Duct Construction Standards in accordance with the following:

Duct Location	Duct Type			
	Supply		Exhaust	Return
	≤ 2 inches wc	> 2 inches wc		
Outdoors	A	A	A	A
Unconditioned Areas	B	A	B	B
Conditioned Spaces				
(concealed ductwork)	C	B	B	C
(exposed ductwork)	A	A	B	B

Sealing Levels

A - All transverse joints, longitudinal seams, and duct wall penetrations

B - All transverse joints and longitudinal seams

C - Transverse joints only

All joints, seams, connections, and penetrations in ductwork located outdoors shall be sealed watertight and weatherproof. Transverse joints shall be flanged and shall be provided with a

continuous gasket and flange cap.

Ductwork shall be supported as required by SMACNA. Where ductwork is connected to equipment, it shall be independently supported with no weight bearing on the equipment and in such a manner that the equipment may be removed for service without temporary support of the ductwork. Ductwork shall be supported within 24 inches [600 mm] of each elbow and within 48 inches [1200 mm] of each branch intersection. Strap or wire hangers shall not be used where the hanger length exceeds 5 feet [1.5 m].

Ductwork shall be constructed and installed in accordance with the drawings. When acceptable to Owner, modifications in the size and location of ductwork may be made where required to avoid interference with the building structure, piping systems, or electrical work. The installation shall be coordinated with other phases of work to establish space and clearance requirements. Unless otherwise indicated by a bottom of duct elevation, all ductwork shall be routed as high as possible, with a minimum height of 8 feet [2.4 m] above the finished floor. Ductwork installed above suspended ceilings shall be installed with at least 8 inch [200 mm] lighting allowance between the ceiling and the bottom of the ductwork.

In vertical ducts with a closed bottom which terminate less than 24 inches [600 mm] above finished floor, the bottom of the ductwork shall be broken and sloped to a 1/2 inch [12.5 mm] drain hole in the bottom of the duct.

Single-thickness turning vanes shall be installed in all turns with 45 degree or greater angles. Turning vanes shall be minimum 4.5 inch [113 mm] radius type for vanes 30 inches and longer.

3-3.12. Duct Insulation. Insulation materials shall be installed in accordance with the manufacturer's written instructions and recommendations. Surfaces which are to be insulated shall be cleaned and dried. Insulation shall be kept clean and dry and shall not be removed from the factory container until it is installed. Packages or factory containers shall have the manufacturer's stamp or label bearing the name of the manufacturer and description of the contents.

Insulation shall be terminated at items mounted in ductwork such as thermometers, controls, damper linkages, flexible connections, access doors, etc., to avoid interference with their function and/or replacement.

The duct liner in the corners of the duct sections shall be folded and compressed or shall be cut and fit to ensure overlapping, butted edges. Top and bottom pieces shall overlap the side pieces. Longitudinal seams shall be made only at corners unless duct dimensions and standard liner product dimensions make seams necessary at other locations.

The duct liner shall be held to the duct by a coat of waterproof, fire-retardant adhesive applied over the entire duct surface. Where duct dimensions exceed 8 inches [200 mm] on any side, mechanical fasteners shall be used in addition to the adhesive. All exposed edges of the duct liner shall be tightly butted and coated with adhesive.

The following ducts shall be insulated with interior duct liner unless indicated on the drawings to be wrapped or otherwise indicated:

<u>Location</u>	<u>Ductwork</u>	<u>Insulation Thickness</u>
Exterior	a. All ductwork	2 inches [50 mm]
Interior within conditioned space (heated or cooled)	a. Heating supply and return	1 inch [25 mm]
	b. Cooling supply and return	1 inch [25 mm]
	c. Heating and cooling supply and return	1 inch [25 mm]
	d. Makeup air outside area served	1 inch [25 mm]
	e. Outside air (including plenums)	1.5 inches [37 mm]
Interior within unconditioned space	a. Heating supply and return	1.5 inches [37 mm]
	b. Cooling supply and return	1.5 inches [37 mm]
	c. Heating and cooling supply and return	1.5 inches [37 mm]
	d. Makeup air outside area served	1.5 inches [37 mm]
	e. Outside air (including plenums)	2 inches [50 mm]

3-3.13. Flexible Duct and Takeoffs. Not used.

3-3.14. Access Doors. Not used.

3-3.15. Temperature Controls. Automatic temperature controls shall be furnished and installed as indicated on the drawings and as specified herein.

Contractor shall be responsible for determining that all equipment supplied is suitable for installation in the space indicated on the drawings. Control equipment shall be installed with adequate space for operating and maintenance access.

The installation shall be checked by the manufacturer in accordance with the Installation Check paragraph.

3-3.15.01. Temperature Control Panels. Not used.

3-3.15.02. Thermostats. Wall-mounted thermostats shall be mounted above the finished floors as indicated in the Electrical section. Insulating spacers shall be provided for thermostats

mounted on exterior building walls. The spacers shall be installed between the thermostat and its mounting surface, so that the thermostat will not be affected by surface temperatures.

Wall-mounted thermostats in non air-conditioned areas shall be furnished and installed with a cast aluminum or wire guard.

3-4. FIELD QUALITY CONTROL.

3-4.01. Installation Check. Where an installation check by the manufacturer is specified in the equipment installation paragraphs above, an experienced, competent, and authorized representative of the manufacturer shall visit the site of the Work and inspect, check, adjust if necessary, and approve the equipment installation. The representative shall be present when the equipment is placed in operation in accordance with the Startup Requirements section, and shall revisit the jobsite as often as necessary until all trouble is corrected and the equipment installation and operation are satisfactory in the opinion of Engineer.

The manufacturer's representative shall furnish a written report certifying that the equipment has been properly installed and lubricated; is in accurate alignment; is free from any undue stress imposed by connecting piping or anchor bolts; and has been operated under full load conditions and that it operated satisfactorily.

All costs for these services shall be included in the Contract Price.

3-4.02. Startup and Testing. After the equipment and systems have been installed, adjusted, and balanced, tests shall be conducted to demonstrate that each system is functioning as specified and to the satisfaction of Engineer. Tests shall be as indicated in the Startup Requirements section.

If inspection or tests indicate defects, the defective work or material shall be replaced, and inspection and tests repeated. All repairs to piping shall be made with new materials. Caulking of threaded joints or holes will not be acceptable.

3-5. CLEANING. At the completion of the testing, all equipment, pipes, ductwork, valves, and fittings shall be cleaned of grease, debris, metal cuttings, and sludge. Any stoppage, discoloration, or other damage to parts of the building, its finish, or furnishings shall be repaired by Contractor at no additional cost to Owner.

End of Section

This page was left blank intentionally

TESTING, ADJUSTING, AND BALANCING

PART 1 - GENERAL

1-1. SCOPE. This section covers the cleaning, testing, adjusting, and balancing of the air system(s) associated with the heating, ventilating, and air conditioning (HVAC), and odor control system(s).

1-2. GENERAL. Equipment and systems shall be cleaned, tested, adjusted, and balanced in full conformity with the drawings, specifications, engineering data, instructions, and recommendations of the equipment manufacturer unless exceptions are noted by Engineer.

1-2.01. Coordination. Contractor shall verify that all components and devices necessary for a properly functioning system have been provided. Prior to cleaning, testing, adjusting, and balancing, Contractor shall verify that each system has been installed properly and is operating as specified. Equipment bearings shall be lubricated in accordance with the manufacturer's recommendations.

Air systems shall be complete and operating, with dampers, filters, ductwork, air outlet and inlet devices, duct mounted equipment, and control components.

1-2.02. Governing Standards. Except as modified or supplemented herein, all work covered by this section shall be performed in accordance with all applicable municipal codes and ordinances, laws, and regulations. In case of a conflict between this section and any state law or local ordinance, the latter shall govern.

All work shall comply with the latest edition of AABC, NEBB, or SMACNA standard manuals for testing, adjusting, and balancing of air systems.

1-3. SUBMITTALS.

1-3.01. Drawings and Data. Complete apparatus report sheets for all air systems shall be accurately and completely filled out in accordance with the Standard's manual. Copies of the final test readings and report sheets shall be submitted in accordance with the Submittals section. A description of the standard procedures used during testing, adjusting, and balancing shall be included in the submittal. The submittal shall include a reduced set of drawings, with the air outlet devices, air inlet devices, and equipment identified to correspond with the report sheets.

The apparatus report sheets shall include the following information:

1. Title Page:
 - a. Company name
 - b. Company address
 - c. Company telephone number
 - d. Project name

- e. Project location
 - f. Project Engineer
 - g. Project Contractor
 - h. Project altitude
 - i. Date
2. Instrument List:
- a. Instrument
 - b. Manufacturer
 - c. Model
 - d. Serial number
 - e. Range
 - f. Calibration date
3. Air Moving Equipment:
- a. Unit number
 - b. Location
 - c. Manufacturer
 - d. Model and serial number
 - e. Airflow, design and actual
 - f. Total static pressure (total external), design and actual
 - g. Static pressure, inlet and discharge
 - h. Total pressure
 - i. Fan RPM, design and actual
4. Electric Motors:
- a. Manufacturer
 - b. Motor type and frame
 - c. HP/BHP
 - d. Phase, voltage, amperage, nameplate, actual, no load.
 - e. RPM
 - f. Service factor
 - g. Starter size, rating, heater elements
5. V-Belt Drive:
- a. Required driven RPM
 - b. Driven sheave make, diameter, and RPM
 - c. Belt make, size, and quantity
 - d. Motor sheave make, diameter, and RPM
 - e. Center to center distance, maximum, minimum, and actual
6. Return Air/Outside Air Data:
- a. Unit number
 - b. System airflow, design and actual
 - c. Return airflow, design and actual
 - d. Outside airflow, design and actual
 - e. Return air temperature
 - f. Outside air temperature
 - g. Mixed air temperature, design and actual
 - h. Outside/return air ratio, design and actual
7. Coil Data: Not used.
8. Duct Traverse:
- a. System zone/branch

- b. Duct size
 - c. Area
 - d. Velocity, design and actual
 - e. Airflow, design and actual
 - f. Duct static pressure
 - g. Air temperature
 - h. Air correction factor
9. Outlet and Inlet Devices:
- a. Air outlet and inlet device number
 - b. Room number/location
 - c. Air outlet and inlet device type
 - d. Air outlet and inlet device size
 - e. Area factor
 - f. Velocity, design, preliminary, and final
 - g. Air flow, design, preliminary, and final
 - h. Percent of design airflow
10. Sound Level Report:
- a. Location
 - b. Octave bands - equipment off
 - c. Octave bands - equipment on
11. Room Air Conditioning Unit.
- a. Unit number
 - b. Location
 - c. Manufacturer and model
 - d. Refrigerant type and capacity
 - e. Airflow, design and actual
 - f. Return airflow, design and actual
 - g. Outside airflow, design and actual
 - h. Dry bulb temperature, entering and leaving
 - i. Wet bulb temperature, entering and leaving
 - j. Outside air temperature, dry and wet bulb
12. Air Terminal Unit Data: Not used.
13. Electric Duct Heater: Not used.
14. Air Cooled Condenser/Heat Pump: Not used.
15. Chillers: Not used.
16. Pump Data: Not used.
17. Heat Exchanger: Not used.
18. Combustion Test: Not used.

1-4. QUALITY ASSURANCE. Contractor shall provide the services of a licensed independent contractor, certified by AABC or NEBB and with proven experience on at least three similar projects, to perform operational testing, adjusting, and balancing of the air systems. The total system balance shall be performed in accordance with AABC, SMACNA, or NEBB Procedural Standards for the work.

1-5. MAINTENANCE. Not used.

PART 2 - PRODUCTS

2-1. SERVICE CONDITIONS. All equipment shall be adjusted or balanced to meet the specified conditions and to operate at the elevation indicated in the equipment sections.

2-2. CONSTRUCTION.

2-2.01. Painting. Surface finish damaged during cleaning, testing, adjusting, and balancing of equipment shall be repaired to the satisfaction of Engineer. Field painting shall be as specified in the architectural painting and Protective Coatings sections.

PART 3 - EXECUTION

3-1. INSPECTION. Before testing and balancing the air system, doors and windows surrounding the area served by the system shall be closed. Fans shall be checked for correct rotation and rotative speed. Dampers shall be open and access doors and panels shall be closed during the testing and balancing period.

A resistance shall be placed at all filter locations to simulate dirty filter conditions. The filter resistance shall be as follows:

<u>Filter Type</u>	<u>Simulated Loss</u>
2 inch [50 mm] pleated	0.35 inch water column [87 Pa]

3-2. STARTUP REQUIREMENTS. System equipment shall be subject to preliminary field tests as indicated in the Electrical section.

3-3. FIELD PERFORMANCE TESTING. Field performance tests shall be conducted for each system to demonstrate each is functioning as specified and to the satisfaction of Engineer. All tests shall be conducted in a manner acceptable to Engineer and shall be repeated as many times as necessary to secure Engineer's acceptance of each system. If inspection or tests indicate defects, the defective item or material shall be replaced, and the inspection and tests shall be repeated. All repairs to piping shall be made with new materials. Caulking of threaded joints or holes will not be acceptable.

3-3.01. Hydronic Piping. Not used.

3-3.02. Refrigerant Piping. Not used.

3-4. CLEANING. At the completion of the testing, all parts of the installation shall be thoroughly cleaned. All equipment, ductwork, pipes, valves, and fittings shall be cleaned of grease, debris, metal cuttings, and sludge. Any stoppage, discoloration, or other damage to parts of the building, its finish, or furnishings shall be repaired by Contractor at no additional cost to Owner.

3-4.01. Chemical Pipe Cleaning. Not used.

3-5. ADJUSTING & BALANCING. The air system shall be adjusted and balanced.

All instrumentation shall be calibrated within 6 months of use and shall be checked for accuracy before testing, adjusting, and balancing the systems. The accuracy of the instrumentation shall be not less than specified by the testing, adjusting, and balancing standard manual or the instrument manufacturer.

All data, including system deficiencies encountered and corrective measures taken, shall be recorded. If a system cannot be adjusted to meet the design requirements, Contractor shall notify Engineer in writing as soon as practicable.

Following final acceptance of the certified balancing reports, the testing and balancing contractor shall permanently mark the settings of all adjustment devices, including valves and dampers, and shall lock the memory stops.

All ceiling tiles, belt guards, panels, and doors removed during testing, adjusting, and balancing shall be reinstalled.

3-5.01. Air Systems. Air systems shall be adjusted to the design airflows indicated on the drawings. Airflows shall be adjusted to maintain a net positive (supply airflow greater than exhaust airflow) or negative (exhaust airflow greater than supply airflow) pressure as indicated on the drawings. Dampers located behind air outlet and inlet devices shall be used to adjust the airflow only to the extent that the adjustments do not create objectionable air movement or noise.

Dampers with operators shall be checked for tight shutoff when in the closed position.

End of Section

This page was left blank intentionally

Section 16050

ELECTRICAL

PART 1 - GENERAL

1-1. SCOPE. This section covers the furnishing and installation of equipment and materials needed for this contract. It also covers conduit, wiring, and terminations for electrical equipment installed under Section 16100.

This section applies to installation and interconnection of electrical equipment furnished under other sections, except electrical items designated to be installed under those sections.

1-2. GENERAL. Electrical apparatus on equipment shall be installed complete and placed in readiness for proper operation.

Electrical materials furnished and installed under this section shall be fabricated, assembled, erected, and placed in proper operating condition in full conformity with the drawings, specifications, engineering data, instructions, and recommendations of the equipment manufacturer, unless exceptions are noted by Engineer.

1-2.01. General Equipment Stipulations. The General Equipment Stipulations shall apply to equipment provided under this section. If requirements in this specification differ from those in the General Equipment Stipulations, the requirements specified herein shall take precedence

Coordination. Electrical work shall conform to the construction schedule and the progress of other trades.

1-2.02. Anchor Bolts and Expansion Anchors. Anchor bolts, nuts, washers, and expansion anchors shall comply with section 05550, Anchorage in Concrete and Masonry, except smaller than 3/4 inch [19 mm] will be permitted to match NEMA standard size bolt holes on motors and electrical equipment.

1-2.03. Drawings. Supplementing this section, the drawings indicate locations of equipment and enclosures and provide one-line and schematic diagrams regarding the connection and interaction with other equipment.

1-3. CODES AND PERMITS. Work shall be performed and materials shall be furnished in accordance with the NEC - National Electrical Code, the NESC - National Electrical Safety Code, and the following standards where applicable

NEC	National Electrical Code
NESC	National Electrical Safety Code,
ANSI	American National Standards Institute.
ASTM	American Society for Testing and Materials.

AWG	American Wire Gauge.
Fed Spec	Federal Specification.
ICEA	Insulated Cable Engineers Association.
IEEE	Institute of Electrical and Electronics Engineers.
IESNA	Illuminating Engineering Society of North America.
NEIS	National Electrical Installation Standards
NEMA	National Electrical Manufacturers Association.
NFPA	National Fire Protection Association.
UL	Underwriters' Laboratories.

Equipment covered by this section shall be listed by UL, or by a nationally recognized third party testing laboratory. Costs associated with obtaining the listing shall be the responsibility of Contractor. If no third-party testing laboratory provides the required listing, an independent test shall be performed at Contractor's expense. Before the test is conducted, Contractor shall submit a copy of the testing procedure to be used.

1-4. IDENTIFICATION.

1-4.01. Conduit. Conduits in manholes, hand holes, building entrance pull boxes, junction boxes, and equipment shall be provided with identification tags. Identification tags shall be 19 gage [1 mm thick] stainless steel, with 1/2 inch [13 mm] stamped letters and numbers as indicated on the drawings. Identification tags shall be attached to conduits with nylon tie wraps and shall be positioned to be readily visible.

1-4.02. Conductors. Conductors in power, control, and instrumentation circuits shall be identified and color coded as described herein.

1-4.02.01. Conductor Identification Number. Except for lighting and receptacle circuits, each individual conductor in power, control, and instrumentation circuits shall be provided with wire identification markers at the point of termination.

Wire markers shall be heat-shrinkable tube type, with custom typed identification numbers. The wire numbers shall be as indicated on the equipment drawings. The wire markers shall be positioned to be readily visible for inspection.

1-4.02.02. Conductor Color Coding. Power conductors shall be color coded as indicated below. For conductors 6 AWG and smaller, the color coding shall be the insulation finish color. For sizes larger than 6 AWG, the color coding may be by marking tape. The equipment grounding conductor shall be green or green with one or more yellow stripes if the conductor is insulated.

The following color coding system shall be used in order of a, b, c, or 1, 2, 3:

- 120/240V — black, red, and white (neutral)
- 208Y/120V — black, red, blue, and white (neutral)

240/120V — black, orange (high leg), blue, and white(neutral)

480V – brown, orange, yellow

480Y/277V — brown, orange, yellow, and gray (neutral)

Where 120/240 and 208Y/120 volt systems share the same conduit or enclosure, the neutral for either the 120/240 volt system shall be white with a permanent identifiable violet stripe.

Control and instrumentation circuit conductors shall be color coded as indicated in the Cable Data Figures at the end of this section.

1-4.03. Motor Starters Motor starters shall be provided with nameplates identifying the related equipment. Pilot controls and indicating lights shall have engraved or etched legends. Nameplates shall be laminated black-over-white plastic, with 1/8 inch [3 mm] engraved letters, and shall be securely fastened to the motor starters with stainless steel screws.

1-4.04. Control Stations. Control stations shall be provided with nameplates identifying the related equipment. Pilot controls and indicating lights shall have engraved or etched legends ("start", "stop", etc.) as indicated on the drawings. Nameplates shall be laminated black-over-white plastic, with 1/8 inch [3 mm] engraved letters, and shall be securely fastened to the control stations with stainless steel screws.

1-4.05. Circuit Breakers. Circuit breakers shall be provided with nameplates identifying related equipment. Nameplates shall be laminated black-over-white plastic, with 1/8 inch [3 mm] engraved letters, and shall be permanently fastened to the circuit breakers with stainless steel screws.

1-4.06. Disconnect Switches. Switches shall have front cover-mounted permanent nameplates that include switch type, manufacturer's name and catalog number, and horsepower [kW] rating. An additional nameplate, engraved or etched, laminated black-over-white plastic, with 1/8 inch [3 mm] letters, shall be provided to identify the associated equipment. Both nameplates shall be securely fastened to the enclosure with stainless steel screws.

1-4.07. Arc Flash Hazard Labels. Lighting panels, power panels, power centers, and meter socket enclosures shall be provided with permanent labels warning the risk of arc flash and shock hazard. Labels shall be designed in accordance with ANSI Z535.4-1998 and shall include the following:

WARNING
Arc Flash and Shock Hazard

Appropriate personal protection equipment (PPE) required. SEE NFPA 70E. Equipment must be accessed by qualified personnel only.

Turn off power sources prior to working on or inside equipment.

1-5. SUBMITTALS. Submit documents in accordance with the submittals section. The drawings and data shall include, but not limited to:

Installation Manual
Operation and Maintenance Manuals
Starters, all types
Motor nameplate data
Complete set of final conform to construction documents

1-5.01. Submittal Identification. Each sheet of descriptive literature submitted shall be clearly marked to identify the material or equipment as applicable:

- a. Lamp fixture descriptive sheets shall show the fixture schedule letter, number, or symbol for which the sheet applies.
- b. Equipment and materials descriptive literature and drawings shall show the specification paragraph for which the equipment applies.
- c. Sheets or drawings covering more than the item being considered shall have inapplicable information crossed out.
- d. A suitable notation shall identify equipment and materials descriptive literature not readily cross-referenced with the drawings or specifications.
- e. Schematics and connection diagrams for electrical equipment shall be submitted for review. A manufacturer's standard connection diagram or schematic showing more than one scheme of connection will not be acceptable.
- f. Transient voltage surge suppressor submittals shall include drawings (including unit dimensions, weights, component and connection locations, mounting provisions, and wiring diagrams), equipment manuals that detail the installation, operation and maintenance instructions for the specified unit(s), and manufacturer's descriptive bulletins and product sheets.

Contractor shall submit the name and qualifications of the Engineering and Testing Services firm proposed to perform the coordination study and the on site testing.

1-6. PROTECTION AND STORAGE. During construction, the insulation on electrical equipment shall be protected against absorption of moisture, and metallic components shall be protected against corrosion by strip heaters, lamps, or other suitable means. This protection shall be provided immediately upon receipt of the equipment and shall be maintained continuously.

PART 2 - PRODUCTS

2-1. POWER SERVICE ENTRANCE. Contractor shall consult the local electric utility, prior to bidding, regarding their service installation requirements, and shall furnish the service equipment in compliance with these requirements. Contractor's bid shall include costs for installation complying with utility requirements. The Utility Company contact information for the pump station is indicated below.

PS-3151 – Progress Energy – James Robinson – 407-942-9201

(Orange County Utilities)
(Master Pump Station Improvements)
(Group 4A1)

16050-4

Bid Issue
October 2012

2-2. CABLE. Cables of each type (such as lighting cable or 600 volt power cable) shall be from the same manufacturer.

Cables shall conform to the Cable Data Figures at the end of this section and as described herein.

2-2.01. Lighting Cable. Lighting cable (Figure 1-16050 XHHW-2) shall be provided only in lighting and receptacle circuits operating at 277 volts or less.

2-2.02. 600 Volt Power Cable. Cable in power, control, indication, and alarm circuits operating at 600 volts or less, except where lighting, multi-conductor control, and instrument cables are required, shall be 600 volt (Figure 1-16050 XHHW-2).

2-2.03. Instrument Cable. Cable for electronic circuits to instrumentation, metering, and other signaling and control equipment shall be two- or three-conductor instrument cable twisted for magnetic noise rejection and protected from electrostatic noise by a total coverage shield. Types of instrument cables shall be as indicated in Figures 2, 3 or 4-16050.

2-2.04. Multi-conductor Control Cable. When indicated on the Drawings, cable in control, indication and alarm circuits shall be multiconductor. Cable shall be Figure 5-16050 14 AWG THHN-THWN.

2.3. CONDUIT.

2-4.01. Rigid Steel Conduit. Not Used

2-4.02. Intermediate Metal Conduit (IMC). Not Used

2-4.03. Liquidtight Flexible Metal Conduit. Liquidtight flexible metal conduit shall be hot-dip galvanized steel, shall be covered with a moisture-proof polyvinyl chloride jacket, and shall be UL listed.

2-4.04. Utility (PVC) Duct. Not Used

2-4.05. Rigid Nonmetallic (PVC) Conduit. PVC conduit shall be heavy wall, Schedule 80, UL labelled for aboveground and underground uses, and shall conform to NEMA TC-2 and UL 651.

2-4.06. Electrical Metallic Tubing (EMT). Not Used

2-4.07. Rigid Aluminum Conduit (RAC). Rigid aluminum conduit and fittings shall be manufactured of 6063-T1 alloy, shall conform to ANSI C80.5, and shall be manufactured in accordance with UL 6.

2-5. WIRING DEVICES, BOXES, AND FITTINGS. Concealed conduit systems shall have flush-mounted switches and convenience outlets. Exposed conduit systems shall have surface-mounted switches and convenience outlets.

2-5.01 Conduit Boxes and Fittings.

- a. Galvanized or cadmium plated, threaded, malleable iron boxes and fittings shall be manufactured by Crouse-Hinds, Appleton, or O Z Gedney. In applications utilizing aluminum conduit systems, aluminum boxes and fittings manufactured by Crouse-Hinds, Appleton, or O Z Gedney shall be installed.
- b. Sheet steel device boxes shall be manufactured by Appleton, Racco, or Steel City.
- c. Hub arrangements on threaded fittings shall be the most appropriate for the conduit arrangement to avoid unnecessary bends and fittings.

2-5.02 . Device Plates.

- a. Galvanized or cadmium-plated device plates shall be used on surface mounted outlet boxes where weatherproof plates are not required.
- b. Device plates on flush mounted outlet boxes where weatherproof plates are not required shall be AISI Type 302 stainless steel, Eagle "93nnn series", Hubbell "S series", or Leviton "840nn-40 series"; nylon or polycarbonate, Eagle "513nV series", Hubbell "Pn series", or Leviton "807nn-I series".
- c. Device plate mounting hardware shall be countersunk and finished to match the plate.
- d. Device plates for switches outdoors or indicated as weatherproof shall have provisions for padlocking switches "On" and "Off", and shall be Appleton "FSK-1VS", Crouse-Hinds "DS185" or O Z Gedney "FS-1-WSCA".
- e. Device plates for receptacles indicated as weatherproof shall be Appleton "FSK-WRD", Crouse-Hinds "WLRD1", or O Z Gedney "FS-1-WDCA".
- f. Flush-mounted, weatherproof plates shall be provided with adapter plates, Appleton "FSK-SBA" or Crouse-Hinds "FS031".
- g. Device plates for ground fault interrupter receptacles indicated to be weatherproof shall be Appleton "FSK-WGFI", Eagle "966", or O Z Gedney "FS-1-GFCA".
- h. Receptacle covers outdoors or otherwise indicated to be weatherproof while in-use shall be die cast aluminum and shall include a padlock eye. Covers for standard convenience outlets shall be Hubbell "WP8M" or Thomas and Betts Red Dot "CKMDV". Covers for ground fault interrupter receptacles shall be Hubbell "WP26M" or Thomas and Betts Red Dot "CKMGV".
- i. Engraved device plates, where required, shall be manufactured by Leviton, or equal.

2-5.03. Wall Switches.

- a. Switches on ac lighting panel load circuits through 277 volts shall be 20 amperes, 120/277 volts.
- b. Switches for pulse control of lighting contactors shall be 20 amperes, 120/277 volts, momentary, double-throw, center "Off",
- c. Switches on ac lighting panel load circuits through 277 volts in Class I, Division 1 and Division 2, Group D hazardous areas indicated on the drawings shall be 20 ampere, 120/277 volts. Hazardous area switches shall be factory sealed tumbler switches

2-5.04. Receptacles.

- a. Standard convenience outlets shall be duplex, three-wire, grounding, 20 amperes, 125 volts
- b. Ground fault circuit interrupter receptacles shall be duplex, 20 amperes, 125 volts
- e. Receptacles in Class I, Division 1 and Division 2, Group D hazardous areas indicated on the drawings shall be three-wire, grounding, 20 amperes, 125 volts. Hazardous area receptacles shall be factory sealed, with an integral switch that is only activated when an approved matching plug is fully inserted and rotated into the engaged position.

2-6. JUNCTION BOXES, PULL BOXES, AND WIRING GUTTERS. Indoor boxes and gutters shall be constructed of sheet steel, shall be galvanized after fabrication, and shall be rigidly supported by hot-dip galvanized hardware and framing materials, including nuts and bolts.

Indoor boxes and gutters in corrosive areas and outdoor boxes and gutters shall be NEMA Type 4X, stainless steel and shall be rigidly supported by stainless steel framing materials. Mounting hardware, which includes nuts, bolts, and anchors, shall be stainless steel. Damaged coatings shall be repaired according to the manufacturer's instructions.

Bolt-on junction box covers 3 feet [900 mm] square or larger, or heavier than 25 lbs [11 kg], shall have rigid handles. Covers larger than 3 by 4 feet [900 by 1200 mm] shall be split.

Junction and pull boxes with a removable side opposite the underground conduits shall be provided over building ends of underground conduit banks. Boxes shall be sized in accordance with the National Electrical Code, including space for full size continuations of underground conduits not originally continued. Conduit arrangement shall leave maximum space for future conduits.

2-7. LIGHTING FIXTURES. Lighting fixtures shall be furnished as described in the fixture schedule. Lighting fixtures shall be furnished complete with lamps. Pendant fixtures shall have swivel type box covers and threaded conduit pendants unless otherwise specified.

2-7.01. Electronic Ballasts. Electronic ballasts furnished with fluorescent type lighting fixtures shall be CBM certified as meeting requirements of ANSI C82.11 with a THD level of not more than 20 percent.

2-8. LIGHTING PANELS. Each lighting panel shall be a dead-front, 120/240 volt or 208Y/120 volt panelboard with bolt-on circuit breakers.

2-8.01. Cabinet. The panel shall have a flush-mounted or surface-mounted enclosure with a NEMA designation appropriate for the location where it will be installed. The enclosure shall have a hinged trim cover. Breaker operating handles shall be accessible through a latched, lockable, door. At the completion of the contract, a neatly printed or typed directory listing the panel and circuit identities shall be mounted inside the door. Hand written will not be acceptable.

2-8.02. Circuit Breakers. Circuit breakers shall be thermal-magnetic, bolt-in, individually front replaceable, and shall indicate "On", "Off", and "Tripped". Breakers indicated as multiple-pole shall be common trip. Breakers shall have interrupting ratings not less than required by analysis. Handle clips to prevent casual operation of breakers shall be provided for 10 percent (at least two) of the breakers and applied to the circuits directed. Breakers and provisions for future breakers shall be provided in the quantities, number of poles, and ampere ratings indicated.

2-8.03. Buses. The panel shall have main and neutral buses insulated from the cabinet, and a ground bus bolted to the enclosure. Buses shall be copper. The ground bus shall be similar to a neutral bus and shall have a good ground connection to the cabinet, a removable bond to the neutral bus, clamp type lugs for the ground cable in each supply conduit, and connections for a ground cable in each load conduit.

2-9. BACK-UP FLOAT CONTROL PANEL The back-up float control panel shall be furnished under specification 13570.

2-10. SURGE PROTECTION DEVICES (SPD'S).

2 -10.01. Scope. Surge Protection Devices (SPD) shall be provided as specified. Each unit shall be designed for parallel connection to the wiring system and shall utilize non-linear voltage-dependent metal oxide varistors (MOV) in parallel.

SPD devices shall be furnished and installed for the electrical equipment indicated, and as specified herein.

Lighting panels shall be rated for the low exposure level capacity.

Power panels, Switchboards, main breakers and main pumps station control panels shall have SPD devices rated for a high exposure levels.

2-10.02. Standards. The specified unit shall be designed, manufactured, tested and installed in compliance with the following standards:

ANSI/IEEE C62.41 and C62.45;

ANSI/IEEE C62.1 and C62.11;

National Electrical Manufacturers Association (NEMA LS1 Guidelines);

National Fire Protection Association (NFPA 20, 70 [NEC], 75, and 78);

Underwriters Laboratories UL 1449 Second Edition and 1283

The unit shall be UL 1449 Second Edition Listed as a Transient Voltage Surge Suppressor and UL 1283 Listed as an Electromagnetic Interference (EMI) Filter.

2-10.03. Environmental Requirements.

- a. Operating Temperature: -40°F to +140°F [-40°C to +60°C].
- b. Relative Humidity: Reliable operation with 5 percent to 95 percent non-condensing.

2-10.04. Electrical Requirements.

- a. Unit Operating Voltage. The nominal unit operating voltage and configuration shall be as indicated on the drawings.
- b. Maximum Continuous Operating Voltage (MCOV). The SPD device shall be designed to withstand a MCOV of not less than 115 percent of nominal RMS voltage.
- c. Operating Frequency. Operating frequency range shall be 47 to 63 Hertz.
- d. Protection Modes. protected modes are defined per NEMA LS-1, Paragraph 2.2.7. Following IEEE Standard 1100, section 9.11.2 recommendations, Four-wire configured systems shall provide, Line-to-Neutral (L-N), Line-to-Ground (L-G), and Neutral-to-Ground (N-G), and Line-to-Line (L-L) protection. Three-wire configured systems shall provide, Line-to-Line (L-L) protection and Line-to-Ground (L-G) protection.
- e. Rated Single Pulse Surge Current Capacity. The rated single pulse surge current capacity, in amps, for each mode of protection of the unit shall be as required and shall be no less than listed in the following table.

	L-N	L-G	N-G	L-L
High Exposure Level	150 kA	150 kA	150 kA	150 kA
Low Exposure Level	80 kA	80 kA	60 kA	80 kA

- f. UL 1449 Second Edition Suppression Voltage Rating (SVR). The maximum SVR per mode for the device (inclusive of disconnect) shall be as required and shall not exceed the following:

Voltage	L-N	L-G	N-G	L-L
120/240	500 V	500 V	500 V	800 V
480 V	900 V	1000 V	1500 V	1800 V

- g. Noise Attenuation. EMI noise rejection or attenuation values shall be measured in accordance with test and evaluation procedures outlined in NEMA LS-1. The unit shall be capable of a minimum -40 dB attenuation at 100kHz when tested per the 50 ohm insertion loss method as defined by MIL-STD-220A.
- h. Minimum Repetitive Surge Current Capacity. The minimum number of repetitive surges per mode as a result of testing a 20 kV, 10kA ANSI/IEEE C62.41 Category C3 surge current with less than a 10 percent degradation of clamping voltage shall be as follows:
For integral and external installation and power panels: 5,000.
For lighting panels: 3,500.
- i. Overcurrent Protection. At high exposure levels, the SPD device shall incorporate internal fusing capable of interrupting, at minimum, up to 200 kA symmetrical fault current with 600 volts ac applied.
At low exposure levels, the SPD device shall incorporate internal fusing capable of interrupting, at minimum, up to 65kA symmetrical fault current with 600 volts ac applied.
The device shall be capable of allowing passage of the rated maximum surge current for every mode without fuse operation.
- j. Unit Status Indicators. The unit shall include long-life, externally visible phase indicators that monitor the on-line status of the unit. When furnished integral to the panelboard, the status indicators shall be viewable through a clear window within the panelboard door, or similar provision made to ensure visibility with the door closed.

2-10.05. Warranty. The manufacturer shall provide a minimum Ten Year Limited Warranty from date of shipment against failure when installed in compliance with applicable national/local electrical codes and the manufacturer's installation, operation and maintenance instructions.

2-10.06. Installation. The SPD devices shall be installed according to the manufacturer's recommendations. If possible for the integral units, provide direct bus connections.

2-10.07. Options.

- a. Disconnect Switch. Each SPD device shall be furnished with an integral disconnect switch. The unit shall be UL 1449 Second Edition listed as such, and the UL 1449 Second Edition Suppression Voltage Ratings shall be provided. The disconnect switch shall be fused and capable of withstanding, without failure, the published maximum surge current magnitude without failure or damage to the switch. A circuit breaker may be used in lieu of an integral disconnect switch.
- b. Enclosure. For the SPD units to be mounted externally of the protected electrical equipment, provide NEMA 4x SS or plastic rated enclosures suitable for the locations indicated on the drawings.

2-10.08. Acceptable Manufacturers. SPD devices shall be manufactured by Surge Suppression Incorporated, Joslyn or Current Technology. The products of other manufacturers will not be acceptable.

2-11. SEPARATELY ENCLOSED MOTOR STARTERS. Separately enclosed motor starters, unless otherwise specified, shall be full voltage, magnetic, non-reversing and NEMA rated. The starter enclosures shall have NEMA type designations appropriate for the locations where they will be installed. NEMA Type 4X stainless steel enclosures shall be provided for outdoor locations.

One thermal overload relay shall be provided in each phase lead. Each starter shall be provided with an external, manually reset push button for resetting the thermal overload relays.

Each starter shall include auxiliary contacts as required, plus one spare NO and one spare NC contact.

Contractor shall match the sizes of control power transformers, overload devices, heaters, and starters to the equipment furnished, as they may differ from the values indicated on the drawings. Control power transformers shall have both primary leads fused, one secondary lead fused, and one secondary lead grounded.

Starters shall be provided with control terminal blocks. Terminal blocks shall be pull-apart type rated 20 amperes. Current carrying parts shall be tin-plated. The removable portion of the terminal blocks shall be used for factory installed wiring.

Push buttons, selector switches, and pilot lights indicated on the schematics to be provided on or in the starter enclosure shall be 30.5 mm heavy-duty, oiltight construction. Pilot lights shall be full voltage type with LED lamps. Push buttons on starters located outdoors shall be provided with protective caps.

2-11.01. Three Phase Starters. Three phase starters shall be circuit breaker combination type consisting of 3 phase, 60 Hz contactors with thermal overloads, a 120 volt ac coil, a dry type control power transformer where required, and a circuit breaker disconnect. Control power transformers shall be sized to handle simultaneous loads. Starters shall be at least NEMA Size 1, or as indicated on the drawings.

Circuit breakers shall be 600 volt magnetic motor circuit protectors for motors smaller than 100 horsepower [75 kW] and 600 volt thermal-magnetic type for 100 horsepower [75 kW] and larger motors. Each breaker shall be manually operated with a quick-make, quick-break, trip-free toggle mechanism.

Three phase starters shall be furnished with external manual breaker operating handles and provisions for up to three padlocks. The access door shall be interlocked with the motor circuit protector, so that the door cannot be opened, except by an interlock override, while the breaker is closed.

The complete 3 phase starter shall have an interrupting rating of at least 42,000 amperes at 480 volts.

2-11.02. Single Phase Starters. Single phase starters shall consist of single phase, 60 Hz contactors with thermal overloads and an integral or separately enclosed short-circuit protection device. Starters shall be at least NEMA Size 0, or shall be sized as indicated on the drawings. Integral short-circuit protection devices for single-phase starters shall be 120/240 volt, magnetic motor circuit protectors.

Separately enclosed short-circuit protection devices for single phase starters shall be molded case circuit breakers for motor loads 6 amperes and higher and fused switch disconnects for motor loads lower than 6 amperes. Circuit breaker disconnects shall be 120/240 volt, molded-case, thermal-magnetic circuit breakers. Fused switch disconnects shall have quick-make, quick-break mechanisms and 250 volt, dual-element, time-delay fuses.

The short-circuit protection devices shall have external operating handles capable of being padlocked in the open position, and shall have an interrupting rating of at least 22,000 amperes at 240 volts.

2-13. CONTROL STATIONS. Control stations shall be provided as indicated on the one-line diagrams or schematics or as required by the equipment furnished. Pilot devices shall be 30.5 mm heavy-duty, oiltight construction, and shall perform the functions indicated. Pilot lights shall be full voltage type with LED lamps. Indoor control stations shall have NEMA Type 13 enclosures. Control stations outdoors or indicated to be weatherproof shall have NEMA Type 4X stainless steel enclosures with protective caps on the control devices. Control stations in NEC Class I, Division 1 and Division 2, Group D hazardous areas shall have NEMA Type 7 enclosures, or be factory sealed type.

2-14. SEPARATELY ENCLOSED CIRCUIT BREAKERS – Not Used

2-15. DISCONNECT SWITCHES. Unless otherwise specified, each disconnect switch shall be 3 pole, non-fusible, 600 volts, with a continuous current rating as indicated.

Switches located indoors shall have NEMA type enclosure designations as required by the locations where they will be installed. Switches located outdoors shall have NEMA Type 4X stainless steel enclosures. Switches in chlorine rooms, or in other areas where contact with caustic substances may occur, shall have NEMA Type 4X enclosures of molded reinforced polyester.

Switches shall have high conductivity copper, visible blades; non-teasible, positive, quick-make, quick-break mechanisms; and switch assembly plus operating handle as an integral part of the enclosure base. Each switch shall have a handle whose position is easily recognizable and which can be locked in the "Off" position with three padlocks. The "On" and "Off" positions shall be clearly marked.

Switches shall be UL listed and horsepower [kilowatt] rated, and shall meet the latest edition of NEMA KS1. Switches shall have defeatable door interlocks that prevent the door from being opened while the operating handle is in the "On" position.

2-16. LIGHTING AND AUXILIARY POWER TRANSFORMERS. Separately mounted transformers shall be provided in the phases, kVA, and voltages indicated. Transformers shall be self-air-cooled, dry type, encapsulated, wall- or floor-mounted, and enclosed for wiring in conduit. Transformers installed outdoors shall be weatherproof. Transformers shall have at least two full capacity voltage taps. Transformers shall meet NEMA TP1 guidelines for energy efficiency.

2-17. LIGHTING CONTACTORS. Not used.

2-18. PHOTOELECTRIC CONTROLS. Not Used.

2-19. RELAY ENCLOSURES. Relay enclosures shall be furnished as indicated. The enclosure shall have a NEMA designation appropriate for the location where it will be installed. Pilot devices shall be heavy duty, oiltight construction. Relays and timers shall have 120 volt, 60 Hz coils rated for continuous duty in 40 C ambient and 10 ampere, 120 volt ac contacts. Intrinsically safe relays shall be installed within the enclosures in accordance with NEC requirements.

2-20. DOOR ENTRY SWITCHES. Switches shall be heavy-duty industrial, adjustable, magnetic wide gap type. Switch and magnet housings located in NEC Class I, Division 1 and 2, Group D hazardous areas shall be die-cast aluminum, explosion-proof. Switch and magnet housings located in other areas shall be anodized aluminum.

PART 3 - EXECUTION

3-1. INSTALLATION, TESTING, AND COMMISSIONING. Material, equipment, and components specified herein shall be installed, tested, and commissioned for operation in compliance with NECA 1000 – NEIS Specification System. Where required in NECA 1000, testing and commissioning procedures shall be followed prior to energizing equipment.

3-2. ARC FLASH HAZARD ANALYSIS. Contractor shall commission an Arc Flash Hazard Analysis for each piece of electrical equipment in accordance with OSHA 29 CFR Part 1910, NEC, NFPA 70E, and IEEE 1584 and shall submit an Arc Flash Hazard Analysis report as specified herein.

The Arc Flash Hazard Analysis shall be performed in association with, or as a continuation of, the short circuit study and protective-device coordination study.

Arc Flash Hazard Analysis calculations shall lead to a selection of a level of Personal Protective Equipment (PPE) that is a balance between the calculated incident energy exposure and the work activity being performed, while meeting the following concerns:

Provide adequate protection.

Avoid the need for more protection than is warranted.

Results of the Arc Flash Hazard Analysis shall be used to identify the flash-protection boundary and the incident energy at assigned working distances throughout any position or level in the overall electrical generation, transmission, distribution, or utilization system.

The analysis shall include, but shall not be limited to, the following:

A tabulation of the symmetrical RMS bolted fault current available and X/R ratio at each piece of electrical equipment.

A tabulation of the arc fault current available at each piece of electrical equipment.

A list containing the incident energy and the flash-protection boundary for electrical equipment.

A list containing each piece of electrical equipment, its corresponding incident energy, hazard rating, and the required Personal Protective Equipment.

An Engineering and Testing Services firm acceptable to Engineer shall conduct the Arc Flash Hazard Analysis.

3-2.01. Arc Flash Analysis Software. The Arc Flash Hazard Analysis shall be performed using the latest version of ETAP or SKM Power*Tools for Windows software, without exception. After the final version of the study and analysis are completed and accepted, Contractor shall provide two (2) copies of the SKM working electronic files to Owner.

3-2.02. Arc Flash Hazard Report. Contractor shall be responsible for submitting complete and accurate arc flash analysis information in the Arc Flash Hazard Report. The report shall be submitted to Engineer for review before the final report is prepared. Contractor shall ensure that calculated values for flash-protection boundary, working distance, incident energy, and required Personal Protective Equipment is submitted and provide substantiation that the information will be prominently displayed on electrical equipment.

The Arc Flash Hazard Analysis report shall be bound in a standard 8-1/2 by 11 inch three-ring binder and shall be submitted in accordance with the submittals section. Final selection of required Personal Protective Equipment shall be subject to review and acceptance by Engineer.

3-2.03. Arc Flash Labeling. After approval of the Arc Flash Hazard Report, Contractor shall furnish and install arc flash warning labels on the applicable electrical equipment. electrical equipment shall be provided with the appropriate ANSI compliant arc flash labeling. Labels shall include the flash protection boundary distance, incident energy, and minimum required Personal Protective Equipment.

3-3. COORDINATION STUDY. Contractor shall commission a short circuit study and protective-device coordination study of relays, fuses, circuit breakers, and other protective devices and shall submit a coordination report as specified herein. The study shall include the entire distribution system, or the portion of the system indicated as required, starting with the smallest – 480 volt, 3 phase, 60 Hz – circuit protective device on the load end, to the nearest protective device on the power company's line side.

Contractor shall be responsible for and shall ensure that relays and circuit breakers are set according to the study results.

The study shall include, but shall not be limited to, the following:

Color-coded printouts of coordination curves prepared with calculation software.

A tabulation of protective relay and circuit breaker trip settings and recommended sizes and types of medium-voltage fuses.

Motor starting profiles for 50 horsepower [37 kW] and larger motors.

Transformer damage curves and protection, evaluated in accordance with ANSI/IEEE C57.109.

Coordination curve(s) from the power company, if available.

Calculated short-circuit values at nodes in the distribution system included within the scope of the coordination study.

An Engineering and Testing Services firm acceptable to Engineer shall conduct the coordination study.

Contractor shall be responsible for obtaining the following:

The coordination curves for relays, fuses, and circuit breakers.

Transformer damage curves.

Motor data.

Other applicable information for new and existing electrical equipment.

Contractor shall coordinate with the power company to obtain the required protective device curves and shall be responsible for the field work associated with obtaining the necessary data on existing relays, circuit breakers, fuses, and transformers to be included in the coordination study.

The available 3 phase, symmetrical fault current at the point of service shall be obtained from the Power Company.

The coordination report shall be bound in a standard 8-1/2 by 11 inch [210 by 275 mm] three-ring binder and shall be submitted in accordance with the submittals section. Final selection of protective device settings or sizes shall be subject to review and acceptance by Engineer.

3-4. POWER AND SERVICE ENTRANCE INSTALLATION. Contractor shall consult the local electric utility regarding their service installation requirements, and shall install the service equipment in compliance with these requirements. Contractor shall install power service equipment components except for components installed by the utility as directed in the utility service installation requirements.

Contractor shall coordinate details and timing of service entrance installations with the utility. Contractor shall complete and submit service applications to the electric utility as necessary.

The Utility Company contact information for the pump station is indicated below.

PS-3151 – Progress Energy – James Robinson – 407-942-9201

3-5. TELEPHONE SERVICE ENTRANCE INSTALLATION. Not Used

3-6. CABLE INSTALLATION.

3-6.01. General. Cable shall be installed according to the following procedures, taking care to protect the cable and to avoid kinking the conductors, cutting or puncturing the jacket, contamination by oil or grease, or any other damage.

- a. Stranded conductor cable shall be terminated by lugs or pressure type connectors. Wrapping stranded cables around screw type terminals is not acceptable.
- b. Stranded conductor cable shall be spliced by crimp type connectors. Twist-on wire connectors may be used for splicing solid cable and for terminations at lighting fixtures.
- c. Splices may be made only at readily accessible locations.
- d. Cable terminations and splices shall be made as recommended by the cable manufacturer for the particular cable and service conditions. Shielded cable stress cone terminations shall be IEEE Class 1 molded rubber type. Shielded cable splices shall be tape or molded rubber type as required. Shielded cable splices and stress cone terminations shall be made by qualified splicers.
- e. Cable shall not be pulled tight against bushings nor pressed heavily against enclosures.
- f. Cable-pulling lubricant shall be compatible with cable jackets; shall not contain wax, grease, or silicone.
- g. Cables operating at more than 2000 volts shall be fireproofed in cable vaults, manholes, and handholes. Fireproofing shall be applied with a half-lapped layer of Arc-Proofing Tape, anchored at each end with a double wrap of Glass Cloth Tape.
- h. Where necessary to prevent heavy loading on cable connections, in vertical risers, the cable shall be supported by woven grips.
- i. Spare cable ends shall be taped, coiled, and identified.
- j. Cables shall not be bent to a radius less than the minimum recommended by the manufacturer. For cables rated higher than 600 volts, the minimum radius shall be 8 diameters for non-shielded cable and 12 diameters for shielded cable.
- k. Cables in one conduit, over 1 foot [305 mm] long, or with any bends, shall be pulled in or out simultaneously.

1. Circuits to supply electric power and control to equipment and devices are indicated on the one-line diagrams. Conductors in designated numbers and sizes shall be installed in conduit of designated size. Circuits shall not be combined to reduce conduit requirements unless acceptable to Engineer.

3-6.02. Underground Cable Pulling Procedure. Care shall be taken to prevent excessive physical stresses that would cause mechanical damage to cables during pulling.

The procedure shall include the following:

- a. Point of cable entrance into the duct system.
- b. Point of cable exit from the duct system.
- c. Type of cable grip to be used.
- d. Type of pulling device to be used.
- e. Method of continuously monitoring cable tension during pulling.
- f. Identification of manholes through which cable will be pulled or where splices will be made.
- g. Size and type of cable sheave assemblies to be used.

3-6.03. Cable Insulation Test. Not Used

3-7. CONDUIT INSTALLATION. Contractor shall be responsible for routing conduits listed on the circuit schedule and panel schedules. Where conduit routing is shown on plans, it shall be considered a general guideline. Contractor field verify locations are suitable prior to installation, and make adjustments as required to avoid interferences with existing facilities, and other new construction activities.

Unless specified otherwise, conduit installation and identification shall be completed according to the following procedures.

3-7.01. Installation of Interior and Exposed Exterior Conduit. This section covers the installation of conduit inside structures, above and below grade, and in exposed outdoor locations. In general, conduit inside structures shall be concealed. Large conduit and conduit stubs may be exposed unless otherwise specified or indicated on the drawings. No conduit shall be exposed in water chambers unless so indicated on the drawings.

- a. Conduit installed in exposed indoor locations, except corrosive areas indicated on the drawings, and in floor slabs, walls, and ceilings of hazardous (classified) locations, shall be rigid aluminium. Exposed conduit shall be rigidly supported by stainless steel hardware and framing materials, including nuts and bolts.
- b. Conduit installed in floor slabs and walls in non-hazardous locations

- shall be rigid Schedule 80 PVC.
- c. Conduit installed in exposed outdoor locations shall be Rigid Aluminum. Mounting hardware, which includes nuts, bolts, and anchors, shall be stainless steel.
 - d. Final connections to dry type transformers, to motors without flexible cords, and to other equipment with rotating or moving parts shall be liquidtight flexible metal conduit with watertight connectors installed without sharp bends and in the minimum lengths required for the application, but not longer than 6 feet [1.8 m] unless otherwise acceptable to Engineer.
 - e. Terminations and connections of rigid aluminum conduit shall be taper threaded. Conduits shall be reamed free of burrs and shall be terminated with conduit bushings.
 - f. Exposed conduit shall be installed either parallel or perpendicular to structural members and surfaces.
 - g. Two or more conduits in the same general routing shall be parallel, with symmetrical bends.
 - h. Conduits shall be at least 6 inches [150 mm] from high temperature piping, ducts, and flues.
 - i. Conduit installed in corrosive chemical feed and storage areas as indicated by Area Type on the drawings shall be rigid Schedule 80 PVC.
 - j. Rigid Schedule 80 PVC conduit shall have supports and provisions for expansion as required by NEC.
 - k. Metallic conduit connections to sheet metal enclosures shall be securely fastened by locknuts inside and outside.
 - l. Rigid Schedule 80 PVC conduit shall be secured to sheet metal device boxes using a male terminal adapter with a locknut inside or by using a box adapter inserted through the knockout and cemented into a coupling.
 - m. Conduits in walls or slabs, which have reinforcement in both faces, shall be installed between the reinforcing steel. In slabs with only a single layer of reinforcing steel, conduits shall be placed under the reinforcement. Conduits larger than 1/3 of the slab thickness shall be concrete encased under the slab.
 - n. Conduits that cross structural joints where structural movement is allowed shall be fitted with concrete tight and watertight expansion/deflection couplings, suitable for use with metallic conduits and rigid Schedule 80 PVC conduits.
 - o. Conduit shall be clear of structural openings and indicated future openings.

- p. Conduits through roofs or metal walls shall be flashed and sealed watertight.
- q. Conduit installed through any openings cut into non-fire rated concrete or masonry structure elements shall be neatly grouted. Conduit penetrations of fire rated structure elements shall be sealed in a manner that maintains the fire rating as indicated on the Architectural Drawings.
- r. Conduits shall be capped during construction to prevent entrance of dirt, trash, and water.
- s. Exposed conduit stubs for future use shall be terminated with galvanized pipe caps.
- t. Concealed conduit for future use shall be terminated in equipment or fitted with couplings plugged flush with structural surfaces.
- u. Where the drawings indicate future duplication of equipment wired hereunder, concealed portions of conduits for future equipment shall be provided.
- v. Horizontal conduit shall be installed to allow at least 7 feet [2.1 m] of headroom, except along structures, piping, and equipment or in other areas where headroom cannot be maintained.
- w. Conduit shall not be routed across the surface of a floor, roof, or walkway unless approved by Engineer.
- x. Conduits that enter enclosures shall be terminated with acceptable fittings that will not affect the NEMA rating of the enclosure.
- y. Nonmetallic conduit, which turns out of concrete slabs or walls, shall be connected to sweep 90 degree elbows of PVC-coated rigid aluminum conduit before it emerges.
- z. Power conductors to and from adjustable frequency drives shall be installed in rigid aluminum conduit.

3-7.02. Underground Conduit Installation. Excavation, backfilling, and concrete work shall conform to the respective sections of these specifications.

- a. Underground conduits shall be concrete encased unless indicated otherwise. Concrete encasement within 15 feet of building entrances, under and within 5 feet of roadways, and within 10 feet of indicated future excavations shall be reinforced.
- b. Concrete encased conduit shall be schedule 40 PVC. Conduits shall have end bells where terminated at walls. Joints shall be solvent welded in accordance with the recommendations of the manufacturer.
- c. Concrete encasement on exposed outdoor conduit risers shall continue to 6 inches [150 mm] above grade, with top crowned and edges chamfered.

- d. Conduit and concrete encasement installed underground for future extension shall be terminated flush at the bulkhead with a coupling and a screw plug. The termination of the duct bank shall be reinforced with bars 100 diameters long that shall be terminated 2 inches [50 mm] from the bulkhead. Matching splice bars shall be 50 bar diameters long. Each longitudinal bar shall be provided with a coupler and plate or a coupler at the bulkhead. The coupler shall be threaded to accept a dowel of like diameter in the future. Threads shall be protected with screw-in plastic caps. A 1-3/4 by 3/4 inch [45 by 20 mm] deep horizontal shear key shall be formed in the concrete encasement above and below the embedded conduits. After concrete placement, conduit and bar connector ends shall be cleaned and coated with two coats of thixotropic coal tar.
- e. Underground conduits indicated not to be concrete encased shall be rigid Schedule 80 PVC.
- f. Underground conduit bend radius shall be at least 2 feet [600 mm] at vertical risers and at least 3 feet [900 mm] elsewhere.
- g. Underground conduits and conduit banks shall have at least 2 feet [600 mm] of earth cover, except where indicated otherwise.
- h. Underground conduit banks through building walls shall be cast in place, or concreted into boxouts, with water stops on sides of the boxout. Water stops are specified in the cast-in-place concrete section.
- i. Underground nonmetallic conduits, which turn out of concrete or earth in outdoor locations, shall be connected to sweep 90 degree elbows of PVC-coated rigid aluminum conduit before they emerge.
- j. Conduits not encased in concrete and passing through walls, which have one side in contact with earth, shall be sealed watertight with special rubber-gasketed sleeve and joint assemblies or with sleeves and modular rubber sealing elements.
- k. Underground conduits shall be sloped to drain from buildings to manholes.
- l. Each 5 kV or higher voltage cable, each 250 kcmil [120 mm²] or larger cable, and each conduit group of smaller cables shall be supported from manhole walls by inserts, or brackets and fiberglass reinforced polyester cable saddles.
- m. Telephone cables shall not be installed in raceways, conduits, boxes, manholes, or hand-holes containing other types of circuits.
- n. Intercommunication and instrument cables shall be separated the maximum possible distance from power wiring in pull-boxes, manholes, and hand-holes.

3-7.03. Sealing of Conduits. After cable has been installed and connected, conduit ends shall be sealed by forcing nonhardening sealing compound into the conduits to a depth at least equal to

the conduit diameter. This method shall be used for sealing conduits at hand-holes, manholes, and building entrance junction boxes, and for 1 inch [25 mm] and larger conduit connections to equipment.

Conduits entering chlorine feed and storage rooms shall be sealed in a junction box or conduit body adjacent to the point of entrance.

Conduits entering hazardous (classified) areas and submersible or explosion proof enclosures shall have sealing fittings with sealing compound.

3-7.04. Reuse of Existing Conduits. Existing conduits shall not be reused.

3-8. WIRING DEVICES, BOXES, AND FITTINGS. Metallic and nonmetallic conduit boxes and fittings shall be installed in the following locations:

3-8.01. Conduit Boxes and Fittings.

- a. Galvanized or cadmium plated, threaded, malleable iron boxes and fittings shall be installed in concrete walls, ceilings, and floors; in the outdoor faces of masonry walls; and in locations where weatherproof device covers are required.
- b. Galvanized or cadmium plated sheet steel boxes shall be installed in the indoor faces of masonry walls, in interior partition walls, and in joist supported ceilings.
- c. Rigid PVC device boxes shall be installed in exposed nonmetallic conduit systems.
- d. PVC coated boxes and fittings shall be installed in PVC coated conduit systems.

3-8.02. Device Plates. Oversized plates shall be installed where standard-sized plates do not fully cover the wall opening.

3-8.03. Wall Switches.

- a. Wall switches shall be mounted 3'-6" [1.05 m] above floor or grade.
- b. After circuits are energized, wall switches shall be tested for proper operation.

3-8.04. Receptacles.

- a. Convenience outlets shall be 18 inches [450 mm] above the floor unless otherwise required.

- b. Convenience outlets outdoors and in garages; in basements, shops, storerooms, and rooms where equipment may be hosed down; shall be 4 feet [1.2 m] above floor or grade.
- c. After circuits are energized, each receptacle shall be tested for correct polarity and each GFCI receptacle shall be tested for proper operation.
- d. Conduit and wire for convenience outlet installation is not shown on the drawings and shall be sized, furnished, and installed by Contractor. Conductors shall be minimum 12 AWG and conduit shall be minimum 3/4 inch for convenience outlet installation.

3-8.05. Special Outlets.

- a. Wall thermostats shall be 4'-6" [1.35 m] above the floor unless otherwise required. Thermostats on exterior walls shall be suitably insulated from wall temperature.
- b. Telephone outlets shall be 18 inches [450 mm] above the floor unless otherwise required. Telephone outlets outdoors and in garages; in basements, shops, storerooms, and rooms where equipment may be hosed down; shall be 4 feet [1.2 m] above floor or grade.
- c. Clock outlets shall be located 7 feet [2.1 m] above the floor.
- d. Horns and strobe lights for audio/visual alarms shall be mounted a minimum of 8 feet above finished floor and shall be positioned to provide maximum penetration of the surrounding area.

3-9. EQUIPMENT INSTALLATION. Except as otherwise specified the following procedures shall be used in performing electrical work.

3-9.01. Setting of Equipment. Equipment, boxes, and gutters shall be installed level and plumb. Boxes, equipment enclosures, metal raceways, and similar items mounted on water- or earth-bearing walls shall be separated from the wall by at least 1/4 inch [6 mm] thick corrosion-resistant spacers. Where boxes, enclosures, and raceways are installed at locations where walls are not suitable or available for mounting, concrete equipment pads, framing material, and associated hardware shall be provided.

3-9.02. Sealing of Equipment. Outdoor substation, switchgear, motor control center, and similar equipment shall be permanently sealed at the base, and openings into equipment shall be screened or sealed with concrete grout to keep out rodents and insects the size of wasps and mud daubers. Small cracks and openings shall be sealed from inside with 100% silicone sealant.

3-10. GROUNDING.

3-10.01. General. The electrical system and equipment shall be grounded in compliance with the National Electrical Code and the following requirements:

- a. Ground conductors shall be at least 12 AWG [4 mm²] soft drawn copper cable or bar.
- b. Ground cable splices and joints, ground rod connections, and equipment bonding connections shall meet the requirements of IEEE 837, and shall be exothermic weld connections or irreversible high-compression connections. Mechanical connectors will not be acceptable. Cable connections to bus bars shall be made with high-compression two-hole lugs.
- c. Ground cable through exterior building walls shall enter within 3 feet [900 mm] below finished grade and shall be provided with a water stop. Unless otherwise indicated, installation of the water stop shall include filling the space between the strands with solder and soldering a 12 inch [300 mm] copper disc over the cable.
- d. Ground cable near the base of a structure shall be installed in earth and as far from the structure as the excavation permits, but not closer than 24 inches [600 mm]. The tops of ground rods and ground cable interconnecting ground rods shall be buried a minimum of 30 inches [750 mm] below grade, or below the frost line, whichever is deeper.
- e. Powered equipment, including lighting fixtures and receptacles, shall be grounded by a copper ground conductor in addition to the conduit connection.
- f. Ground connections to equipment and ground buses shall be made with copper or high conductivity copper alloy ground lugs or clamps. Connections to enclosures not provided with ground buses or ground terminals shall be made with irreversible high-compression type lugs inserted under permanent assembly bolts or under new bolts drilled and inserted through enclosures, other than explosion proof enclosures, or by grounding locknuts or bushings. Ground cable connections to anchor bolts; against gaskets, paint, or varnish; or on bolts holding removable access covers will not be acceptable.
- g. The grounding system shall be bonded to the station piping by connecting to the first flange inside the building, on either a suction or discharge pipe, with a copper bar or strap. The flange shall be drilled and tapped to provide a bolted connection.
- h. Ground conductors shall be routed as directly as possible, avoiding unnecessary bends. Ground conductor installations for equipment ground connections to the grounding system shall have turns with minimum bend radii of 12 inches [300 mm].
- i. Ground rods not described elsewhere shall be a minimum of 3/4 inch [19 mm] in diameter by 30 feet [3 m] long, with a copper jacket bonded to a steel core.
- j. Test wells and covers for non-traffic areas shall be molded high density polyethylene. Test wells for traffic areas shall be precast concrete construction rated for traffic duty with concrete or cast iron covers.

3-10.02. Grounding System Resistance. The grounding system design depicted on the contract drawings is the minimum design required for each building or structure. Each system shall comply with the maximum resistance of 5 ohms to ground, which may require additional equipment which exceeds minimum required by NEC. Contractor shall confirm the system grounding resistance with the results of the testing specified herein. Systems exceeding the maximum resistance specified shall be supplemented with additional grounding provisions and retested until the maximum specified resistance is achieved.

3-10.03. Grounding System Testing. The grounding system of each new building, electrical distribution system or structure and each existing building or structure indicated below, shall be tested to determine the resistance to earth. Testing shall be performed by an independent electrical or grounding system testing organization. Testing shall be completed after not less than three full days without precipitation and without any other moistening or chemical treatment of the soil.

3-10.03.01. New Grounding Systems. Grounding systems of each new building, electrical distribution system or structure shall be tested for resistance to earth utilizing the three-point fall of potential test as defined by IEEE 81. Testing shall be completed prior to installation of the electrical distribution equipment to ensure the grounding system is isolated from the utility grounding system and the systems of other structures. The current source probe for the test shall be placed in soil at a distance of 5 to 10 times the distance of the widest measurement across the grounding system ring or grid to ensure adequate measurements outside of the grounding system's sphere of influence. Test probe measurements shall be taken at a distance of one foot from the grounding system reference connection and at each 10 percent increment from the grounding system reference connection to the current source probe location. Test results shall be documented on a graphical plot with resistance in ohms on the vertical axis and distance in feet on the horizontal axis. The results shall clearly indicate a system resistance plateau which confirms a valid test procedure.

3.10.03.02. Existing Grounding Systems. Not used.

3-11. LIGHTING FIXTURE INSTALLATION. The drawings indicate the general locations and arrangements of the lighting fixtures. Fixtures in rows shall be aligned both vertically and horizontally unless otherwise specified. Fixtures shall be clear of pipes, mechanical equipment, structural openings, indicated future equipment and structural openings, and other obstructions.

Conduit and wire for lighting fixture installation is not shown on the drawings and shall be sized, furnished and installed by Contractor. Circuits to emergency lighting units, exit signs, and fixtures indicated to be night lights shall not be switched. Circuits to fluorescent lighting fixtures indicated to have emergency battery packs shall include an additional un-switched hot conductor. Conductors shall be minimum 12 AWG and conduit shall be minimum 3/4 inch for lighting fixture installation.

3-12. MODIFICATIONS TO EXISTING EQUIPMENT. Modifications to existing equipment shall be as required to maintain existing pumping operations during construction of new facilities. Temporary power or relocation of existing power and control wiring, equipment, and devices shall be provided as required during construction. Coordination and timing of outages

shall be as necessary. Electrical power interruptions will only be allowed where agreed upon in advance with Owner, and scheduling at times of low demand may be required.

3-12.01. Demolition. Existing cable, conduit and equipment shall be removed as part of this project. Conduit supports and electrical equipment mounting hardware shall be removed, and holes or damage remaining shall be grouted or sealed flush. Conduit partially concealed shall be removed where exposed, and plugged with expanding grout flush with the floor or wall unless it interferes with new construction, in which it shall be completely removed. Repairs shall be refinished to match the existing surrounding surfaces. Demolished equipment shall be removed from the site and legally discarded or salvaged.

End of Section

This page was left blank intentionally

STANDARD SPECIFICATIONS

REFERENCE: ICEA S-95-658 (NEMA WC 70).

CONDUCTOR: Concentric-lay, uncoated copper; strand Class B. Wet/dry maximum operating temperature 90°C.

INSULATION: Cross-linked thermosetting polyethylene, ICEA S-95-658, Paragraph 3.6.

SHIELD: None.

JACKET: None.

FACTORY TESTS: Cable shall meet the requirements of ICEA S-95-658.

Cable Details

Size		Number of Strands	Conductor Insulation Thickness*		Maximum Outside Diameter	
AWG or kcmil	mm ²		in.	µm	in.	mm
14	2.5	7	0.030	760	0.17	4.32
12	4.0	7	0.030	760	0.19	4.83
10	6.0	7	0.030	760	0.21	5.33
8	10.0	7	0.045	1140	0.27	6.86
6	16.0	7	0.045	1140	0.31	7.87
4	25.0	7	0.045	1140	0.36	9.14
2	35.0	7	0.045	1140	0.42	10.67
1	40.0	19	0.055	1400	0.48	12.19
1/0	50.0	19	0.055	1400	0.52	13.21
2/0	70.0	19	0.055	1400	0.57	14.48
4/0	95.0	19	0.055	1400	0.68	17.27
250	120.0	37	0.065	1650	0.75	19.05
350	185.0	37	0.065	1650	0.85	21.59
500	300.0	37	0.065	1650	0.98	24.89
750	400.0	61	0.080	2030	1.22	31.00
1,000	500.0	61	0.080	2030	1.37	34.80

*The average thickness shall be not less than that indicated above. The minimum thickness shall be not less than 90 percent of the values indicated above.

A durable marking shall be provided on the surface of the cable at intervals not exceeding 24 inches (600 mm). Marking shall include manufacturer's name, XLP, XHHW-2, conductor size, and voltage class.

600 Volt, Single Conductor Lighting/Power Cable (600-1-XLP-NONE-XHHW-2)

BLACK & VEATCH

Cable Data

Figure 1-16050

STANDARD SPECIFICATIONS

REFERENCE: UL 62, UL 1277.

CONDUCTOR: 16 AWG (1.5 mm²), 7-strand, concentric-lay, uncoated copper. Maximum operating temperature 90°C dry, 75°C wet.

INSULATION: Polyvinyl chloride, not less than 15 mils (380 μm) average thickness; 13 mils (330 μm) minimum thickness, UL 62, Type TFN.

LAY: Twisted pair with 1-1/2 inch to 2-1/2 inch (38.10 mm - 63.5 mm) lay.

SHIELD: Cable assembly, combination aluminum-polyester tape and 7-strand, 20 AWG (0.5 mm²) minimum size, tinned copper drain wire, shield applied to achieve 100 percent cover over insulated conductors.

JACKET: Conductor: Nylon, 4 mils (100 μm) minimum thickness, UL 62.
Cable assembly: Black, flame-retardant polyvinyl chloride, UL 1277, applied over tape-wrapped cable core.

CONDUCTOR IDENTIFICATION: One conductor black, one conductor white.

FACTORY TESTS: Insulated conductors shall meet the requirements of UL 62 for Type TFN. Assembly jacket shall meet the requirements of UL 1277. Cable shall meet the vertical-tray flame test requirements of UL 1277.

Cable Details

	Assembly Jacket Thickness*		Maximum Outside Diameter	
	in.	μm	in.	mm
Single Pair	0.045	1140	0.34	8.64

*The average thickness shall be not less than that indicated above. The minimum thickness shall be not less than 80 percent of the value indicated above.

A durable marking shall be provided on the surface of the cable at intervals not exceeding 24 inches (600 mm). Marking shall include manufacturer's name, Type TC, Type TFN, conductor size, single pair, and voltage class.

600 Volt, Single Pair, Shielded Instrument Cable (600-SINGLE-PAIR-SH-INSTR)

BLACK & VEATCH

Cable Data

Figure 2-16050

STANDARD SPECIFICATIONS

REFERENCE: UL 62, UL 1277.
 CONDUCTOR: 16 AWG (1.5 mm²), 7-strand, concentric-lay, uncoated copper. Maximum operating temperature 90°C dry, 75°C wet.
 INSULATION: Polyvinyl chloride, not less than 15 mils (380 μm) average thickness; 13 mils (330 μm) minimum thickness, UL 62, Type TFN.
 LAY: Twisted triad with 1-1/2 inch to 2-1/2 inch (38.10 mm - 63.5 mm) lay.
 SHIELD: Cable assembly, combination aluminum-polyester tape and 7-strand, 20 AWG (0.5 mm²) minimum size, tinned copper drain wire, shield applied to achieve 100 percent cover over insulated conductors.
 JACKET: Conductor: Nylon, 4 mils (100 μm) minimum thickness, UL 62.
 Cable assembly: Black, flame-retardant polyvinyl chloride, UL 1277, applied over tape-wrapped cable core.
 CONDUCTOR IDENTIFICATION: One conductor black, one conductor white, one conductor red.
 FACTORY TESTS: Insulated conductors shall meet the requirements of UL 62 for Type TFN. Assembly jacket shall meet the requirements of UL 1277. Cable shall meet the vertical-tray flame test requirements of UL 1277.

Cable Details

	Assembly Jacket Thickness*		Maximum Outside Diameter	
	in.	μm	in.	mm
Single Triad	0.045	1140	0.35	8.87

*The average thickness shall be not less than that indicated above. The minimum thickness shall be not less than 80 percent of the value indicated above.

A durable marking shall be provided on the surface of the cable at intervals not exceeding 24 inches (600 mm). Marking shall include manufacturer's name, Type TC, Type TFN, conductor size, single triad, and voltage class.

600 Volt, Single Triad, Shielded Instrument Cable (600-SINGLE-TRIAD-SH-INSTR)

BLACK & VEATCH

Cable Data

Figure 3-16050

STANDARD SPECIFICATIONS

REFERENCE: UL 62, UL 1277.

CONDUCTOR: 18 AWG (0.75 mm²), 7-strand, concentric-lay, uncoated copper. Maximum operating temperature 90°C dry, 75°C wet.

INSULATION: Polyvinyl chloride, not less than 15 mils (380 μm) average thickness; 13 mils (330 μm) minimum thickness, UL 62, Type TFN.

LAY: Twisted pairs or triads with 1-1/2 inch to 2-1/2 inch (38.10 - 63.5 mm) lay.

SHIELD: Each pair or triad and cable assembly: Combination aluminum-polyester tape and 7-strand, 20 AWG (0.5 mm²) minimum size, tinned copper drain wire, shield applied to achieve 100 percent cover over insulated conductors. Shield tape on pair and/or triad assemblies shall be applied in such a way as to give total shield isolation from other pairs' or triads' shields.

JACKET: Conductor: Nylon, 4 mils (100 μm) minimum thickness, UL 62.

Cable Assembly: Black, 90°C, flame-retardant polyvinyl chloride, UL 1277, Table 10.17, applied over tape-wrapped cable core.

CONDUCTOR IDENTIFICATION:

Pair: One conductor black, one conductor white.

Triad: One conductor black, one conductor white, one conductor red.

PAIR Identification: Each pair and/or triad numbered.

FACTORY TESTS: Insulated conductors shall meet the requirements of UL 62 for Type TFN. Assembly jacket shall meet the requirements of UL 1277. Cable shall meet the vertical-tray flame test requirements of UL 1277.

Cable Details

	Assembly Jacket Thickness*		Maximum Outside Diameter	
	in.	μm	in.	mm
Number of Pairs				
4	0.045	1140	0.554	14.07
8	0.060	1520	0.749	19.02
12	0.060	1520	0.896	22.76
24	0.060	1520	1.256	31.90
Number of Triads				
4	0.060	1520	0.648	16.46
8	0.060	1520	0.823	20.99
12	0.080	2030	1.030	26.16
24	0.080	2030	1.393	35.38

*The average thickness shall be not less than that indicated above. The minimum thickness shall be not less than 80 percent of the values indicated above.

A durable marking shall be provided on the surface of the cable at intervals not exceeding 24 inches (600 mm). Markings shall include manufacturer's name, Type TC, Type TFN, conductor size, number of pairs or triads, and voltage class.

**600 Volt, Multiple Pair and/or Triad, Shielded Instrument Cable
(600-MULTI-PAIRS-TRIADS-SH-INSTR)**

BLACK & VEATCH

Cable Data

Figure 4-16050

STANDARD SPECIFICATIONS

REFERENCE: UL 83, UL 1277, ICEA S-73-532, ICEA S-58-679.

CONDUCTOR: 14 AWG (2.5 mm²), 7 or 19 strands, concentric-lay, uncoated copper. Maximum operating temperature 90°C dry, 75°C wet.

INSULATION: Polyvinyl chloride, not less than 15 mils (380 μm) average thickness; 13 mils (330 μm) minimum thickness, UL 83, Type THHN and THWN.

SHIELD: None.

JACKET: Conductor: Nylon, 4 mils (100 μm) minimum thickness, UL 83.

Cable assembly: Black, flame-retardant polyvinyl chloride, UL 1277, applied over tape-wrapped cable core.

CONDUCTOR IDENTIFICATION: ICEA S-58-679, Method 1, Table 2 or ICEA S-58-679, Method 3, Table 2. White or green conductors shall not be provided.

FACTORY TESTS: Insulated conductors shall meet the requirements of UL 83 for Type THHN-THWN. Assembly jacket shall meet the requirements of UL 1277. Cable shall meet the flame test requirements of UL 1277 for Type TC power and control tray cable.

Cable Details

Number of Conductors	Assembly Jacket Thickness*		Maximum Outside Diameter	
	in.	μm	in.	mm
2	0.045	1140	0.38	9.65
3	0.045	1140	0.39	9.91
4	0.045	1140	0.44	11.18
5	0.045	1140	0.46	11.68
7	0.045	1140	0.49	12.45
9	0.045	1140	0.61	15.49
12	0.060	1520	0.66	16.76
19	0.060	1520	0.77	19.56
24	0.060	1520	0.93	23.62
30	0.080	2030	0.98	24.89
37	0.080	2030	1.05	26.67

*The average thickness shall be not less than that indicated above. The minimum thickness shall be not less than 80 percent of the values indicated above.

A durable marking shall be provided on the surface of the cable at intervals not exceeding 24 inches (600 mm). Marking shall include manufacturer's name, Type TC, Type THWN or THHN, conductor size, number of conductors, and voltage class.

600 Volt, Multiconductor 14 AWG (2.5 mm²) Control Cable (600-MULTI-THHN-THWN)

BLACK & VEATCH

Cable Data

Figure 5-1605026 05 11

This page was left blank intentionally

Section 16100

ELECTRICAL EQUIPMENT INSTALLATION

PART 1 - GENERAL

1-1. SCOPE. This section covers the installation of electrical equipment.

1-2. GENERAL. Equipment specified to be installed under this section shall be erected, and placed in proper operating condition in full conformity with drawings, specifications, engineering data, instructions, and recommendations of the equipment manufacturer, unless exceptions are noted by ENGINEER.

The electrical equipment identified as being provided by others will be furnished complete for installation by CONTRACTOR. Technical specifications under which the equipment will be purchased are available.

1-2.01. Coordination. When manufacturer's field services are provided by the equipment manufacturer, CONTRACTOR shall coordinate the services with the equipment manufacturer. CONTRACTOR shall give ENGINEER written notice at least 14 days prior to the need for manufacturer's field services furnished by others.

Submittals for equipment furnished under the original procurement contract will be furnished to CONTRACTOR upon completion of review by ENGINEER. CONTRACTOR shall review equipment submittals and coordinate with the requirements of the Work and the Contract Documents. CONTRACTOR accepts sole responsibility for determining and verifying all quantities, dimensions, and field construction criteria.

1-3. DELIVERY, STORAGE, AND HANDLING.

1-3.01. Delivery. When sills are required for electrical equipment, they shall be shipped ahead of the scheduled equipment delivery to permit installation before concrete is placed.

1-3.02. Storage. Upon delivery, all equipment and materials shall immediately be stored and protected by CONTRACTOR in accordance with Section 01614, and in accordance with manufacturer's written instructions, until installed in the Work. Equipment shall be protected by CONTRACTOR against damage and exposure from the elements. At no time shall the equipment be stored on earth or grass surfaces or come into contact with earth or grass. CONTRACTOR shall keep the equipment clean and dry at all times. Openings shall be plugged or capped (or otherwise sealed by packaging) during temporary storage.

1-3.03. Handling. Electrical equipment shall be moved by lifting, jacking, or skidding on rollers as described in the manufacturer's instructions. Special lifting harness or apparatus shall be used when required. Lifting and jacking points shall be used when identified on the equipment. CONTRACTOR shall have required unloading equipment on site to perform unloading work on the date of equipment delivery.

1-4. ARC FLASH HAZARD LABELS. Switchgear, switchboards, motor control centers, motor control line-ups, and transfer switches shall be provided with permanent labels warning the risk of arc flash and shock hazard. Labels shall be designed in accordance with ANSI Z535.4-1998 and shall include the following information:

WARNING
Arc Flash and Shock Hazard

Appropriate personal protection equipment (PPE) required. See NFPA 70E.
Equipment must be accessed by qualified personnel only.
Turn off all power sources prior to working on or inside equipment.

Additional information shall be provided on the labels where specified in the Arc Flash Hazard Analysis section of specification 16050.

PART 2 - PRODUCTS

Not used.

PART 3 - EXECUTION

3-1. INSTALLATION, TESTING, AND COMMISSIONING. All installation work shall be in accordance with manufacturer's written instructions.

All material, equipment, and components specified to be installed according to this Section shall be installed, tested, and commissioned for operation in compliance with NECA 1000 – NEIS Specification System. Where required in NECA 1000, testing and commissioning procedures shall be followed prior to energizing equipment.

Electrical equipment cubicles and vertical sections shall be installed plumb and level. Drawout equipment carriages, circuit breakers, and other removable components shall operate free and easy without binding or distortion.

Unless otherwise indicated or specified, all indoor floor-mounted electrical equipment and control cabinets shall be installed on concrete equipment pads four inches [102 mm] in height.

3-1.01. Cleaning. All deposits of oil, grease, mud, dirt or debris shall be cleaned from the electrical equipment following installation and field wiring. A detergent water based solution, or other liquid cleaners not harmful to material or equipment finishes, shall be used as recommended by the manufacturer.

End of Section

Section 16150

ADJUSTABLE FREQUENCY DRIVES

PART 1 - GENERAL

1-1. SCOPE. This section covers pulse width modulated (PWM) type adjustable frequency drives (AFD). AFDs shall meet the design conditions and features specified herein. Reference the driven equipment specification 11150 for coordination requirements for the AFD system. The supplier of the driven equipment shall also furnish the AFD's.

1-2. GENERAL. Equipment furnished and installed under this section shall be fabricated, assembled, erected, and placed in proper operating condition in full conformity with drawings, specifications, engineering data, instructions, and recommendations of the equipment manufacturer, unless exceptions are noted by Engineer.

Equipment provided under this Section shall be fabricated as specified in this Section and as shown on the schematics and one line diagrams on the Contract Drawings.

Unless otherwise indicated on the drawings, one adjustable frequency drive, complete with all required control components, shall be furnished for each motor.

AFDs shall be manufactured and assembled in their entirety at the manufacturer's factory. Systems fabricated or assembled in whole or in part by parties other than the drive manufacturer will not be acceptable.

1-2.01. Coordination. The design of the adjustable frequency drive shall be coordinated with the driven equipment. Contractor shall be responsible for coordinating the collection of data and the design effort to limit harmonics to the levels specified.

The manufacturer of the driven equipment shall be responsible for furnishing the adjustable frequency drives.

1-2.02. General Equipment Stipulations. The General Equipment Stipulations shall apply to all equipment furnished under this section. If requirements in this specification differ from those in the General Equipment Stipulations, the requirements specified herein shall take precedence.

1-2.03. Dimensional Restrictions. Layout dimensions will vary between manufacturers and the layout area indicated on the drawings is based on typical values. The supplier shall review the Contract Drawings, the manufacturer's layout drawings and installation requirements, and make any modifications required for proper installation subject to acceptance by Engineer.

1-2.04. Workmanship and Materials. Equipment supplier shall guarantee all equipment against faulty or inadequate design, improper assembly or erection, defective workmanship or materials, and leakage, breakage, or other failure. Materials shall be suitable for service conditions.

All equipment shall be designed, fabricated, and assembled in accordance with applicable governing standards. Individual parts shall be manufactured to standard sizes and thicknesses so that repair parts, furnished at any time, can be installed in the field. Like parts of duplicate units shall be interchangeable. Equipment shall not have been in service at any time prior to delivery, except as required by tests.

1-2.05. Governing Standards. The adjustable frequency drive shall be designed, constructed, and tested in accordance with the applicable standards of NEMA, ANSI, UL, and IEEE, and shall be designed for installation in accordance with the NEC.

The equipment covered by this section shall be listed by UL or a nationally recognized third-party testing laboratory. All costs associated with obtaining the listing shall be the responsibility of Contractor. In the event no third-party testing laboratory provides the required listing, an independent test shall be conducted at Contractor's expense. Before the test is conducted, Contractor shall submit a copy of the testing procedure to Engineer.

1-2.06. Nameplates. Nameplates with the description and designation of each control or indicating device shall be provided. Unless specified otherwise, each drive enclosure shall be provided with a nameplate bearing the unit designation as indicated above. Nameplates shall be black and white laminated phenolic material of suitable size, and shall be engraved with 3/8 inch [10 mm] high letters for the drive designation and 3/16 inch [5 mm] letters for other information. The engraving shall extend through the black exterior lamination to the white center.

Each control device and each control wire terminal block connection inside the enclosure shall be identified with permanent nameplates or painted legends to match the identification on the manufacturer's wiring diagram.

1-3. DESCRIPTION. The AFD shall produce an adjustable ac voltage/frequency output and shall be equipped with an output voltage regulator to maintain correct output V/Hz despite incoming voltage variations.

1-3.01. Six-Pulse Drives. Not used.

1-3.02. Eighteen-Pulse Drives. Drives for motors shall be of the pulse-width modulated type and shall consist of an 18-pulse, full-wave diode or gated-open SCR bridge. The rectifier shall convert incoming fixed voltage and fixed frequency to a fixed dc voltage. The pulse-width modulation technology shall be of the space vector type, implemented in a microprocessor that generates a sine-coded output voltage.

The phase shifting transformer required to produce the phase shifted input to the 18-pulse rectifier shall be factory wired and mounted within the drive enclosure as an integral part of the drive assembly. External transformers shall not be required.

The AFD inverter output shall be generated by insulated gate bipolar transistors (IGBT) which shall be controlled by identical base driver circuits. The AFD shall not induce excessive power losses in the motor. The worst case RMS motor line current measured at rated speed, torque, and voltage shall not exceed 1.05 times the rated RMS motor current for pure sine wave operation.

1-4. SUBMITTALS. Complete assembly, foundation, and installation drawings, together with complete engineering data covering the materials used, parts, devices, and accessories forming a part of the drive shall be submitted in accordance with the submittals section. The drawings and data shall include, but shall not be limited to, the following:

- a. Name of manufacturer.
- b. Types and model numbers.
- c. Rated drive input kVA and output kVA.
- d. Percent efficiency at 100 percent speed and 60 percent speed.
- e. Maximum Btu [kJ] heat release data and verification of the drive cooling requirements.
- f. Total weight and lifting instructions, height, mounting, and floor space required.
- g. Panel interior and front and side exterior view details showing maximum overall dimensions of all transformer, bypass contactor, ac line filter, ac line reactor, and drive compartments.
- h. Schematics, including all interlocks.
- i. Wiring diagrams, including all internal and external devices and terminal blocks.
- j. Locations and sizes of electrical connections, ground terminations, and shielded wires.
- k. List of diagnostic indicators.
- l. List of fault and failure conditions that the drive can recognize and indicate for simultaneous occurrence.
- m. List of standard features and options.
- n. List of spare parts to be furnished.
- o. Input line protection model numbers and manufacturer's data sheets.
- p. Output filter model number and manufacturer's data sheets.
- q. UL 508C Certificate of Compliance for short circuit current rating.
- r. Listing of factory setting of AFD and RVSS parameters
- s. Solid State Reduced voltage starter information

1-5. OPERATION AND MAINTENANCE DATA AND MANUALS. Adequate operation and maintenance information shall be supplied. Operation and maintenance manuals shall be submitted in accordance with the submittals section.

Operation and maintenance manuals shall include the following:

- a. Manufacturer's operation and maintenance manual for each size of adjustable frequency drive and solid state reduced voltage starter.
- b. Manufacturer's standard manuals for each size and type of bypass contactor, transformer, line reactor, and filter.
- c. Schematics, wiring diagrams, and panel drawings in conformance with construction record.
- d. Model numbers and up-to-date cost data for spare parts.
- e. Troubleshooting procedures, with a cross-reference between symptoms and corrective recommendations.
- f. Connection data to permit removal and installation of recommended smallest field-replaceable parts.
- g. Information on testing of power supplies and printed circuit boards and an

explanation of the drive diagnostics.

The operation and maintenance manuals shall be in addition to any instructions or parts lists packed with or attached to the equipment when delivered.

1-6. SPARE PARTS. The drive manufacturer shall provide spare parts for each type and size of drive supplied. The spare parts shall include at least one complete set of all plug-in components for each size and type of drive, and shall include the following:

Power fuses

Control fuses

Indicating lights

Rectifier power semiconductors

Inverter power semiconductors

One of each type printed circuit board and gate firing board

Other field-replaceable component parts as recommended by manufacturer.

Spare parts shall be suitably packaged, as specified herein, with labels indicating the contents of each package. Spare parts shall be delivered to Owner as directed.

1.7. DELIVERY, STORAGE, AND HANDLING. Shipping shall be in accordance with the Shipping section. Handling and Storage shall be in accordance with the Handling and Storage section.

PART 2 - PRODUCTS

2-1. ACCEPTABLE MANUFACTURERS. Drives shall be pulse-width modulated type, as manufactured by Siemens-Robicon, Allen-Bradley, General Electric, Eaton Cutler-Hammer or Schneider Electric/Square D without exception. The products of other manufacturers will not be acceptable.

All adjustable frequency drives shall be a product of the same manufacturer.

2-2. PERFORMANCE AND DESIGN REQUIREMENTS.

2-2.01. Performance. The adjustable frequency drive controller shall be of sufficient capacity and shall produce a quality output waveform for stepless motor control from 10 to 100 percent of base speed. The adjustable frequency drive shall be suitable for loads and shall have voltage ratings as follows:

The adjustable frequency drive shall be suitable for operation at site elevation, and shall meet the following ratings and parameters:

Input frequency	60 Hz
-----------------	-------

Input voltage and frequency variation	±10 percent voltage variation, ±2 Hz; imbalance, 2 percent maximum. Continued operation with additional momentary 25 percent voltage dip of 0.5 second duration from nominal input voltage level.
Minimum drive efficiency	95 percent at 100 percent speed, 90 percent at 60 percent speed.
Ambient temperature	0 to 40°C.
Relative Humidity	0 to 95 percent non-condensing.
Displacement Power Factor	95 percent or higher throughout the entire operating speed range, measured at drive input terminals.
Drive service factor	1.0.
Overcurrent capability	110 percent for 1 minute for variable torque; 150 percent for 1 minute for constant torque.
Volts/Hz ratio	Voltage varies as the square of frequency over the entire range of the unit for variable torque drives, linear over the entire range of the unit for constant torque drives; except under voltage boost condition.
Acceleration/deceleration time	Adjustable over a range that meets the requirements of the drive equipment.
Output speed regulation	0.5 percent.
Output frequency stability	0.5 percent of nominal.

2-2.02. Adjustments. The following drive adjustments shall be provided:

- Maximum speed.
- Minimum speed.
- Linear acceleration time.
- Linear deceleration time.
- Volts/Hz ratio; linear, squared, and automatic settings.
- Voltage boost.
- Process follower gain, offset, and bias.
- Torque limit.
- Critical frequency avoidance with adjustable bandwidth.

2-2.03. Fault Protection. Design of the power circuit shall include provisions for protection against fault conditions as follows.

2-2.03.01. Input Protection.

The drive assembly shall be UL 508C listed. A UL Certificate of Compliance shall be submitted to confirm product compliance with UL 508C and to indicate the short circuit current rating. The short circuit current rating shall meet or exceed the available short circuit current indicated on the Contract Drawings.

Solid state instantaneous overcurrent trip set at 180 percent.

Adjustable overvoltage and undervoltage protection with automatic restart.

Phase loss and reverse phase trip with manual restart.

2-2.03.02. Internal Protection.

AC line, phase-to-phase transient voltage surge suppression utilizing metal oxide varistors. Drive shall meet the requirements of IEEE C62.41.

Power device snubbers.

Power devices rated 2.5 times line voltage.

Instantaneous overcurrent.

Static overspeed (overfrequency) protection.

DC bus overvoltage trip.

Components and labeling that comply with UL 508 requirements. Drives shall be equipped with an automatic discharge circuit to deplete the charge on the DC capacitor bank to less than 50 volts within 60 seconds after main input power is removed. Labels indicating derivative voltage sources and required wait time for servicing after power removal shall be placed on all applicable enclosures.

Individual transistor over temperature and over current protection.

Control logic circuit malfunction indication.

2-2.03.03. Output Protection.

Inverse-time motor overload protection adjustable from 10 percent to 100 percent.

Overvoltage protection.

Over frequency protection.

Short circuit protection (three phase, phase to phase, and ground fault protection).

Protection against opening or shorting of motor leads.

Static overspeed protection.

Stall protection on overload with inverse time overcurrent trip, adjustable current limit from 10 percent to 120 percent.

2-2.04. Harmonic Distortion Abatement. The electrical system shall be provided with the necessary equipment to protect the drive and the power system ahead of the drive from harmonic distortion, as described below. The harmonic distortion abatement analysis shall be based on the information on the Contract Drawings and on the follow:

Short circuit current at utility interface	PS-3151 – Coordinate with Utility Company
Connected current at utility interface	PS-3151 – 511.0 amps

The drive shall operate satisfactorily when connected to a bus supplying other solid-state power conversion equipment which may be causing up to 10 percent total harmonic voltage distortion and commutation notches up to 36,500 volt-microseconds.

Harmonic distortion abatement equipment shall be provided to bring the facility and its electrical system into compliance with IEEE 519, 1992 at the points of analysis defined below and indicated on the Contract Drawings.

2-2.04.01. Current Distortion Limits. Maximum allowable total and individual harmonic current distortion limits for each odd harmonic shall not exceed limits set forth in IEEE 519, 1992. The utility connection shall be the primary point of analysis for current distortion. The values of utility short circuit current at the utility interface and the total maximum running amperes of all equipment powered from the utility connection shall be as indicated above.

2-2.04.02. Voltage Distortion Limits. Individual or simultaneous operation of the drives shall result in a maximum total harmonic voltage distortion of 5 percent on the bus feeding the drives. Individual or simultaneous operation of the drives shall not add more than 10 percent total harmonic voltage distortion to the bus feeding the drives while operating from a standby generator. The point(s) of analysis for harmonic voltage distortion testing shall be the nearest electrical bus on the supply side of each drive. The three phase fault current at the bus feeding the drives is as indicated on the one-line drawings.

2-3. CONSTRUCTION. Construction requirements shall be as follows and as specified below:

2-3.01. Fabrication and Assembly. The adjustable frequency drive system shall be shop assembled in a single enclosure using interchangeable plug-in printed circuit boards and power conversion components wherever possible. Shop assembly shall be performed by the drive manufacturer; systems fabricated or assembled in whole or in part by parties other than the drive manufacturer will not be acceptable. Changes to the drive manufacturer's product by a distributor or system integrator are not allowed.

Input line reactors, fuses, circuit breakers, and filters, where required, shall be mounted within the drive enclosure, without exception. Isolation/voltage matching transformers, where required, may be enclosed separately from the remaining drive equipment.

The adjustable frequency drive system shall be designed to fit in the space indicated on the drawings.

2-3.02. Wiring. Internal cabinet wiring shall be neatly installed in wireways or with wire ties where wireways are not practical. Where wireway is used, they are to be mounted to the panel surface with a continuous run of 3M brand, or equal, industrial two-sided adhesive strip. For 12 AWG wire sizes and smaller, and in bundles of six or less, wire tie-down square mounting straps shall be permitted. Tie-down mounts shall be installed at 8" increments or less. All mounting surfaces shall be pre-cleaned with isopropyl alcohol to ensure proper adhesion over the life of the equipment.

Terminal blocks shall be nonbrittle, interlocking, track-mounted type, complete with a marking strip, covers, and pressure connectors. Screw terminals will not be acceptable. A terminal shall be provided for each conductor of external circuits, plus one ground for each shielded cable. In freestanding panels, 8 inches [200 mm] of clearance shall be provided between terminals and the panel base for conduit and wiring space. Not less than 25 percent spare terminals shall be provided. Terminals shall be labeled to agree with the identification on the submittal drawings. Each control loop or system shall be individually fused, clearly labeled, and located for ease of maintenance.

All grounding wires shall be attached to the sheet metal enclosure with a ring tongue terminal. The surface of the sheet metal shall be prepared to ensure good conductivity and corrosion protection.

Wires shall not be kinked or spliced and shall be color coded or marked on both ends. The markings or color coding shall agree with the submittal drawings.

With the exception of electronic circuits, all interconnecting wiring and wiring to terminals for external connection shall be stranded copper, insulated for at least 600 volts, with a moisture-resistant and flame-retardant covering rated for at least 90°C.

2-3.03. Enclosures. The drive shall consist of factory mounted and wired components within an enclosure, arranged so no electrically live components, terminals, or conductors are accessible on the front panel or door when the enclosure door is open.

The complete drive package, including accessories, shall fit into the space indicated on the drawings.

Freestanding panels shall be suitable for mounting on a concrete pad and shall include provisions for anchoring to the supporting structure. Suitable lifting facilities shall be provided for handling and shipment.

Relays, terminals, and special devices inside the control enclosure shall have permanent markings to match the identification on the manufacturer's wiring diagrams.

2-3.04. Printed Circuit Boards. All printed circuit boards shall be sprayed on both sides with a conformal coating. The conformal coating shall be a part of the AFD manufacturing process and shall be selectively applied to the circuit board connections only. Heat sinks and resistors on the circuit board shall not be coated. Conformal coating shall be Konform "C416", HumiSeal, or equal.

All plug-in type boards shall be mechanically held at the circuit board connector. Compression fit only at the connector will not be acceptable.

2-3.05. Shop Painting. All iron and steel surfaces, except machined surfaces and stainless steel, shall be shop cleaned in accordance with the coating manufacturer's recommendations, and finished with the drive manufacturer's standard coating. Finish color shall be manufacturer's standard color. Dry film thickness of the finish coat shall be at least 4 mils [100 µm]. Field painting, other than touch up, will not be required. A sufficient quantity of additional coating material and thinner shall be furnished for field touch up of damaged coatings. A corrosion resistant coating shall be furnished.

All intermediate and finish coating materials shall be fumeproof and suitable for a wastewater treatment plant atmosphere that contains hydrogen sulfide. Documentation verifying that the coating material is fumeproof shall be submitted. Coatings shall be lead-free and mercury-free.

2-4. OPTIONAL EQUIPMENT.

2-4.01. Combination Solid-State Starters. As required, or as indicated on the drawings, the AFD enclosure shall include a breaker combination, solid-state, reduced voltage solid state starter. Six back-to-back silicon controlled rectifiers shall be used to provide smooth, stepless motor acceleration. When the motor reaches full speed, a bypass contactor shall close and carry the continuous duty motor current. This bypass contactor shall bypass the SCRs of the solid state starter once the motor is up to speed. The effect of the bypass contactor during run shall be for the elimination of heat buildup resulting from the voltage drop across the SCRs of the solid state starter. It is the intent of the OWNER to use the RVSS as a means of starting the motor should problems be encountered with the AFD. Therefore, the RVSS shall be rated for motor starting duty and a selector switch shall be supplied mounted through the enclosure door such that the starting means can be selected as being either through the solid state starter or through the AFD.

- a. Starters shall be 3 phase, 60 Hz, with overloads, a 120 volt ac bypass contactor coil, a dry-type control transformer, and a molded-case circuit breaker. Control transformers shall be mounted with the removable starters and shall have capacity for all simultaneous loads. Control transformers shall have both primary leads fused, one secondary lead fused, and one secondary lead grounded.
- b. As required, spare interlock contacts, whether on the starter or on a relay, shall be wired separately to the unit terminal board.
- c. Starters shall include smooth starting and stopping, adjustable starting torque, adjustable ramp time, inverse time overload current trip, current limit, phase loss protection, and adjustable electronic overloads.
- d. An external manual breaker operating handle with provisions for up to three padlocks shall be provided on each starter. The access door shall be interlocked with the circuit breaker so that the door cannot be opened, except by an interlock override, while the breaker is closed.
- e. CONTRACTOR shall match control transformers, overloads, and the minimum sizes of starters to equipment furnished, which may differ from the estimated values indicated on the drawings. Overload relay devices shall be adjusted to reflect reduced motor current caused by

- load-side power factor correction capacitors (if required).
- g. Unless otherwise specified, spare starters shall have breakers and overloads sized for the largest rated motor and 100 watts extra transformer capacity.
- h. As required, starters shall include an auxiliary contactor for connection to a line-side power factor correction capacitor. The contactor shall be interlocked to prevent the capacitor from being connected before the bypass contactor has energized.

2-4.02. AC Line Reactors. Where used, AC line reactors shall be designed to address performance issues of NEMA MG1-20.55 and to provide proper transient protection of the AFD input power devices. AC line reactors shall be factory mounted and wired within the AFD enclosure. AC line reactors shall be K-rated per IEEE C57-110 and shall be TCI Model KLR, or equal.

2-4.03. Harmonic Filters. When harmonic filters are required to comply with the total harmonic distortion limits specified herein, the AFD manufacturer shall design and provide the required filters. The harmonic filters shall utilize an interlocking contactor that shall be automatically operated by the AFD run circuit. The AFD manufacturer shall be responsible for the complete filter unit, including the filter contactor. Harmonic filters shall be TCI Harmonic Guard HG7 Series, or equal.

2-4.04. Isolation/Voltage Matching Transformers. Not used.

2-4.05. Power Factor Correction Capacitors. Not used.

2-4.06. Output dV/dt Filters. Not used.

2-5. CONTROLS.

2-5.01. Features. Each drive shall include the following features in addition to those indicated on the drawings:

- a. Door mounted membrane keypads with integral two-line, 24 character minimum LCD display that is capable of controlling the AFD/RVSS and setting parameters. The keypad module shall be programmed with factory set drive or RVSS parameters in nonvolatile EEPROM or FLASH memory and shall be resettable in the field through the keypad. A listing of the factory settings shall be provided as part of the submittal information. One keypad shall be provided for the AFD and one keypad shall be provided the RVSS.
- b. Control switches and pilot lights shall be provided as indicated on the schematic diagrams. Manual-automatic and start-stop controls included as features of the drive keypad shall be password protected or disabled to prevent override of control switches and safety interlocks shown on the schematic diagrams.
- c. Control switches and pilot lights shall be 30.5 mm heavy-duty, oiltight

- construction. Pilot lights shall be full voltage type with LED lamps.
- d. Microprocessor-based regulator. Nonvolatile memory modules shall have a useful life of at least 20 years without requiring battery or module replacement.
 - e. Input thermal-magnetic molded-case circuit breaker disconnect with interrupting capacity rated in RMS symmetrical amperes as required, and labeled in accordance with UL standard 489. The disconnect shall be mounted inside the controller enclosure and shall have door interlocks and a handle with provisions for padlocking in the "Off" position.
 - f. Manual speed adjustment.
 - g. Indications of power "On", drive "Run", and drive "Fault". Indication of these parameters shall be provided by pilot lights that utilize full voltage LED lamps. Lamps shall be easily replaceable from the front of the indicating light.
 - h. Elapsed time meter.
 - i. Speed indication - calibrated in percent rpm.
 - j. Control circuits of not more than 115 volts supplied by internal control power transformers. Control power transformers shall have additional capacity as required by external devices indicated on the drawings. Control power transformers shall be equipped with two primary leads fused, one secondary lead fused, and one secondary lead grounded.
 - k. Automatic controller shutdown on overcurrent, overvoltage, undervoltage, motor over temperature and other drive fault conditions. Controller shutdown shall be manually reset type. Terminals shall be provided for control wiring from motor temperature switches, or a motor protection relay located in the drive enclosure.
 - l. Diagnostic indicators that pinpoint failure and fault conditions. Indicators shall be manually reset to restore operation after abnormal shutdown.
 - m. Accept a remote 4-20 mA speed control signal.
 - n. Process control output for remote 4-20 mA speed indication, rated 0 to 100 percent speed.
 - o. Spare interlock contacts rated 5 amperes at 120 volts ac, wired separately to the unit terminal board. One NO and one NC isolated spare interlock shall be furnished with each drive. Additional interlock contacts shall be provided as indicated on the drawings.
 - p. Drive fault and run status contacts for remote indication, rated 5 amperes at 120 volts ac.
 - q. Speed droop feature, which reduces the speed of the drive on transient overloads. The drive shall return to set speed after the transient is removed. If the acceleration or deceleration rates are too rapid for the moment of inertia of the load, the drive shall automatically compensate to prevent drive trip.
 - r. Individual adjustable speed profile settings for start, stop, entry, slope, and minimum and maximum speed points.
 - s. Coast, controlled ramp, or dc injection selectable modes of stopping.
 - t. PID setpoint control selection.
 - u. Adjustable PWM carrier frequency. The inverter output section shall be provided with adjustable PWM carrier frequency from 500 Hz to at least

8 kHz.

- v. Noise level of installed equipment shall not exceed 85 dB, as measured by an appropriate calibrated instrument. The required sound level limit shall be met at a minimum of four locations, each not more than 3 feet [0.9 m] above the floor and not more than 10 feet [3 m] from the equipment. This requirement shall apply to all drives, motors, filters, reactors, and transformers supplied with the drive.

2-5.02. Diagnostics. Diagnostic indicators on the face of the drive shall display the type of fault responsible for drive shutdown, warning, or failure. If two or more faults occur simultaneously, the diagnostic segment shall record or indicate each condition. The drive shall be capable of storing 6 events.

2-5.03. Motor Protection Relay. Not used.

2-6. TESTING. All power switching components shall be pre-run under anticipated operating temperature and load conditions. Any alternative testing procedures shall be submitted and pre-approved before proceeding.

2-6.01. Factory Testing. After the drive system has been assembled at the manufacturer's facility, it shall be tested for at least 24 hours before it is shipped.

The complete drive system, including all peripherals, shall be factory tested under simulated operating conditions, including normal operating sequences and fault conditions. Contact closure inputs and simulated driven-outputs shall be connected to the system input/output modules.

A test report summary indicating satisfactory final test results shall be submitted to Engineer before shipment of the equipment.

PART 3 - EXECUTION

3-1. INSTALLATION. Installation will be in accordance with Section 16100.

3-1.01. Commissioning and Start-Up. Provide commissioning and testing of equipment. Provide software and all programming. Provide coordination and start-up assistance with the driven equipment.

All cost for these services shall be included in the Contract Price.

3-2. FIELD QUALITY CONTROL.

3-2.01. Installation Check. An experienced, competent, and authorized representative of the manufacturer shall visit the site of the Work and inspect, check, adjust if necessary, set all relays in accordance with the settings designated in the coordination study, and approve the equipment installation. The representative shall be present when the equipment is placed in operation in accordance with Section 01650, and shall revisit the job site as often as necessary until all

trouble is corrected and the equipment installation and operation are satisfactory in the opinion of Engineer.

The manufacturer's representative shall furnish a written report certifying that the equipment has been properly installed and lubricated; is in accurate alignment; is free from any undue stress imposed by connecting piping or anchor bolts; and has been operated under full load conditions and that it operated satisfactorily.

All costs for these services shall be included in the Contract Price.

3-2.02. Installation Supervision. Installation supervision by the manufacturer is not required.

3-3. FIELD HARMONIC DISTORTION TEST. Not used.

This page was left blank intentionally

GENERAL PURPOSE INDUCTION MOTORS

PART 1 - GENERAL

1-1. SCOPE. This section covers single and three-phase, small (fractional) and medium (integral) horsepower, alternating current motors rated 500 horsepower and less (NEMA MG1).

Motors shall be designated and coordinated with the driven equipment and shall be located as indicated on the drawings.

1-2. GENERAL. Motors furnished under Driven Equipment Specification sections shall be fabricated and assembled in full conformity with drawings, specifications, engineering data, instructions, and recommendations of the equipment manufacturer unless exceptions are noted by the ENGINEER.

1-2.01. General Equipment Stipulations. The General Equipment Stipulations shall apply to all motors, unless otherwise specified. If requirements in this specification differ from those in the General Equipment Stipulations, the requirements specified herein shall take precedence.

1-2.02. Governing Standards. Motors furnished under this section shall be designed, constructed, and tested in accordance with the latest version of NEMA MG 1 and IEEE 112, Test Method B.

1-2.03. Nameplates. All motor nameplate data shall conform to NEMA MG 1 requirements.

1-3. SUBMITTALS. Complete assembly, foundation, and installation drawings, together with complete engineering data covering the materials used, parts, devices, and accessories forming a part of the motor shall be submitted in accordance with the submittals section. The drawings and data shall include, but shall not be limited to, the following:

Motors

- Name of manufacturer.
- Type and model.
- Type of bearing and method of lubrication.
- Rated size of motor, hp [kW], and service factor.
- Temperature rise and insulation rating.
- Full load rotative speed.
- Net weight.
- Efficiency at full, 3/4, and 1/2 load.
- Full load current.
- Locked rotor current.
- Space heater wattage, where applicable.
- Motor temperature switch data, where applicable.
- RTD data, where applicable.

1-4. OPERATION AND MAINTENANCE DATA AND MANUALS. Adequate operation and maintenance information shall be supplied. Operation and maintenance manuals shall be submitted in accordance with the submittals section.

Operation and maintenance manuals shall include the following:

- a. Assembly, installation, alignment, adjustment, and checking instructions.
- b. Lubrication and maintenance instructions.
- c. Guide to troubleshooting.
- d. Parts lists and predicted life of parts subject to wear.
- e. Outline, cross-section, and assembly drawings; engineering data; and wiring diagrams.
- f. Test data and performance curves, where applicable.

PART 2 - PRODUCTS

2-1. SERVICE CONDITIONS. Service conditions for motors shall be as specified in the driven equipment specification sections. Motors shall be designed for special conditions such as area classification, altitude, frequent starting, intermittent overload, high inertia, mounting configuration, or service environment. Where site elevation and ambient temperature is not specified in the driven equipment specification sections, the motors shall be designed for the following.

Site elevation	Below 3,300 ft [1,000 m]
Ambient temperature	50 °C

Unless specified otherwise, all motors shall be designed for full voltage starting and to operate from an electrical system that may have a maximum of 5 percent voltage distortion according to IEEE 519.

Motors utilizing a reduced-voltage, autotransformer starter shall be capable of reduced-voltage starting at a 65 percent tap setting.

Motors utilizing a reduced voltage solid state starter shall be capable of starting at 50% of the specified voltage.

When powered from an adjustable frequency drive (AFD), motors shall be inverter duty and specifically selected for service with an adjustable frequency type speed controller and shall be derated as required to compensate for harmonic heating effects and reduced self-cooling capability at low speed operation. Each motor shall not exceed a Class B temperature rise when operating in the installed condition at load with power received from the adjustable frequency drive. All motors driven by AFDs shall be supplied with full phase insulation on the end turns

and shall meet the requirements of NEMA MG 1, Part 31. In addition to the requirements of NEMA MG 1, Part 31, motors shall be designed to be continually pulsed at the motor terminals with a voltage of 1600 volts ac.

2-2. PERFORMANCE AND DESIGN REQUIREMENTS. Design and construction of each general-purpose motor shall be as specified herein. Motor voltage, frequency, speed, service factor, and insulation class shall be as follows.

Motor voltage.	460, 3 phase for ½ horsepower and larger, 120, single phase for smaller than ½ horsepower
Frequency.	60 Hz
Speed.	Constant speed
Service factor.	1.15
Insulation class and temperature rise above 40° C design ambient (by resistance method.	Class F with 80° C rise at 1.0 SF
Enclosure.	Totally enclosed fan cooled
Main conduit box sized to include.	Main motor leads and space heater leads where space heaters are specified

2-2.01. Nameplate Horsepower. Motor nameplate horsepower [kW] shall be equal to or greater than the maximum load imposed by the driven equipment.

2-2.02. Enclosures. All motors shall be self-ventilated. All self-ventilated open type motors, including those with dripproof, splashproof, and weather protected enclosures, and the fan covers of totally enclosed fan cooled motors shall meet NEMA MG 1 requirements for a fully guarded machine.

2-2.02.01. Totally Enclosed Motors. Totally enclosed motors shall be furnished with drain holes and rotating shaft seals. Frames, bearing brackets, external terminal housings, and fan covers for fan cooled motors shall be cast iron. External cooling fans for fan cooled motors shall be fabricated of brass, bronze, aluminum alloy containing not more than 0.2 percent copper, malleable iron, or plastic. All plastic fans shall be fabricated of a reinforced thermosetting plastic and shall be UL approved.

2-2.02.02. Outdoor Motors. Outdoor motors shall have NEMA weather protected enclosures. All exposed metal surfaces shall be protected, where practical, with a corrosion resistant polyester coating. Exposed uncoated surfaces shall be of a corrosion resistant metal. Enclosure exterior and interior surfaces, air gap surfaces, and windings shall be protected with a corrosion resistant alkyd enamel, polyester, or epoxy coating.

2-2.02.03. Motors for Hazardous Locations. Motors for hazardous locations shall be in accordance with the NEC and of the correct type enclosures for the particular service as specified in NEMA MG 1. Motors shall meet the requirements of UL 674.

2-2.02.04. Encapsulated Windings. Where required, motors shall be provided with encapsulated windings meeting the requirements of NEMA MG1-1.27.2.

2-2.02.05. Severe Duty Chemical Service Motors. Motors shall be provided with special corrosion-resistant finish and encapsulated windings meeting the requirements of NEMA MG1-1.27.2 and IEEE 841.

2-2.03. Main Conduit Boxes. The main conduit box shall be in accordance with NEMA MG 1. The main conduit boxes shall be diagonally split for easy access to the motor leads, and designed for rotation in 90-degree increments. A gasket shall be furnished between the halves of the box. Conduit openings in the main conduit box shall match the size and quantity of conduits indicated on the one line drawings.

The main conduit box shall be oversized at least one size larger than NEMA standard. The main conduit box shall be sized for all indicated accessory leads.

Motors furnished in NEMA 320 frame series and larger shall have conduit boxes designed and constructed to permit motor removal after installation without disconnecting raceways.

2-2.04. Leads. Motor power leads shall be wired into the main conduit box. Unless otherwise specified, space heater leads shall be wired into the main conduit box. All motor leads and their terminals shall be permanently marked in accordance with the requirements of NEMA MG 1, Part 2. Each lead marking shall be visible after taping of the terminals.

All motors rated 100 horsepower [74 kW] and larger, and all vertical motors shall have the direction of rotation marked by an arrow mounted visibly on the stator frame near the terminal housing, or on the nameplate, and the leads marked for phase sequence T1, T2, T3, to correspond to the direction of rotation and supply voltage sequence.

Leads for dual-voltage rated or for multispeed motors shall be easily connected or reconnected in the main conduit box for the operating voltage or for the specified speeds. Permanent instructions for making these connections shall be furnished inside the main conduit box or on the motor frame or nameplate.

2-2.05. Terminals. Cable type leads shall be provided with Burndy Type YA or acceptable equal compression type connectors.

2-2.06. Grounding Connections. All motors shall be furnished with a ground connection.

2-2.07. Bearings. All bearings shall be self-lubricating, shall have provisions for relubrication, and shall be designed to operate in any position or at any angle.

Motor bearings shall be antifriction type with L₁₀ life rating of 40,000 hours in accordance with AFBMA Standards.

All bearing mountings shall be designed to prevent the entrance of lubricant into the motor enclosure or dirt into the bearings, and shall be fitted with pipes, drain plugs, and fittings arranged for safe, easy relubrication from the outside of the motor while the motor is in service, as necessary.

2-2.08. Rotors. All induction motors shall have squirrel-cage rotors adequately sized to avoid overheating during acceleration of the motor and driven equipment. Rotors shall be dynamically balanced to 0.08 in./sec [2.03 mm/s] or less.

2-2.09. Shafts. Shafts shall be furnished with corrosion resistant treatment or shall be of a corrosion resistant material.

2-2.10. Torque Characteristics. Motors rated 200 horsepower [149 kW] and less shall have torques and locked-rotor current in accordance with NEMA MG 1, Part 12.

2-2.11. Motor Space Heaters. Unless otherwise specified, motors 1 horsepower and larger shall be provided with a space heater element sized to prevent condensation on the core and windings. The space heaters shall be isolated or so located as to prevent heat damage to adjacent painted surfaces and shall be suitable for 120 volt, 60 Hz, single phase power supply.

2-2.12. Temperature Sensing Devices. Each motor controlled by an adjustable frequency drive shall be furnished with at least one automatic reset winding temperature switch per phase. Temperature switch contacts shall be normally closed and rated 5 amps at 120 volts ac. The contacts shall be wired in series with the end leads brought out to the motor terminal box.

2-2.13. Assembly. All motors shall be completely assembled with the driven equipment, lubricated, and ready for operation.

2-2.14. Efficiency. Motors shall be premium efficiency type and shall have a NEMA nominal efficiency nameplate value equal to or greater than values indicated in the following table. Efficiency shall be determined in accordance with IEEE 112, Test Method B.

Vertical motors shall have efficiency values equal to or greater than those indicated in the following table minus 0.50.

Motor		Nominal Efficiency Values Open Drip Enclosure				Nominal Efficiency Values TEFC Enclosure			
kW	hp	3600 rpm	1800 rpm	1200 rpm	900 rpm	3600 rpm	1800 rpm	1200 rpm	900 rpm
0.7	1	84.0	85.5	82.5	75.0	77.0	85.5	82.5	75.5
1.1	1.5	84.0	86.5	86.5	78.0	84.0	86.5	87.5	80.0
1.5	2	85.5	86.5	87.5	86.5	85.5	86.5	88.5	85.5
2.2	3	85.5	89.5	88.5	89.5	87.0	89.5	89.5	86.5
3.7	5	86.5	89.5	89.5	89.5	88.5	89.5	89.5	85.5
5.6	7.5	88.5	91.0	90.2	88.5	90.0	91.7	91.0	86.5
7.5	10	89.5	91.7	91.7	91.0	91.0	91.7	91.0	91.0

Motor		Nominal Efficiency Values Open Drip Enclosure				Nominal Efficiency Values TEFC Enclosure			
kW	hp	3600 rpm	1800 rpm	1200 rpm	900 rpm	3600 rpm	1800 rpm	1200 rpm	900 rpm
11.2	15	90.2	93.0	91.7	91.0	91.0	92.4	92.0	91.0
14.9	20	91.7	93.0	92.4	92.0	92.0	93.0	92.0	91.0
18.7	25	92.4	93.6	93.0	92.0	92.0	93.6	93.0	91.0
22.4	30	93.0	94.1	93.6	93.0	92.4	93.6	93.0	93.0
29.8	40	93.0	94.1	94.1	93.0	92.4	94.1	94.1	93.0
37.3	50	93.0	94.5	94.1	93.0	93.0	94.5	94.1	93.0
44.8	60	93.6	95.0	94.5	94.0	93.6	95.0	94.5	93.0
56	75	94.0	95.0	95.0	94.0	93.6	95.4	95.0	94.0
74.6	100	94.5	95.4	95.0	95.0	94.1	95.4	95.0	94.0
93.2	125	95.0	95.4	95.0	95.0	95.0	95.4	95.0	94.0
112	150	95.0	95.8	95.4	95.0	95.0	95.8	95.8	94.0
149	200	95.4	95.8	95.4	95.0	95.4	96.2	95.8	94.1
186	250	95.0	95.8	95.4	95.0	95.8	96.2	95.8	94.5
224	300	95.4	95.8	95.4		95.8	96.2	95.8	
261	350	95.4	95.8	95.4		95.8	96.2	95.8	
298	400	95.8	95.8	95.8		95.8	96.2	95.8	
336	450	95.8	96.2	96.2		95.8	96.2	95.8	
373	500	95.8	96.2	96.2		95.8	96.2	95.8	

2-3. ACCESSORIES.

2-3.01. Special Tools and Accessories. Motors requiring periodic repair and adjustment shall be furnished complete with all special tools, instruments, and accessories required for proper maintenance. Each motor shall be provided with lifting eyebolts or lugs and appropriate fittings for adding bearing lubricant. Grease lubricated units shall be provided with a means of venting the casing. Oil lubricated units shall be provided with constant level oilers or with sight glasses arranged to indicate operating and static oil levels.

2-4. ANCHORS. CONTRACTOR shall furnish suitable anchors for each item of equipment as required for driven equipment.

2-5. BALANCE. All rotating parts shall be accurately machined and shall be in as nearly perfect rotational balance as practicable. Excessive vibration shall be sufficient cause for rejection of the equipment. The mass of the unit and its distribution shall be such that resonance at normal operating speeds is avoided. In any case, the unfiltered vibration displacement (peak-to-peak), as measured at any point on the machine, shall not exceed the limits as required. At any operating speed, the ratio of rotative speed to the critical speed of a unit or its components shall be less than 0.8 or more than 1.3.

PART 3 - EXECUTION

3-1. INSTALLATION. Each motor will be installed in accordance with the Equipment Installation section.

End of Section

This page was left blank intentionally

SWITCHBOARDS

PART 1 - GENERAL

1-1. SCOPE. This section covers switchboard equipment, which shall be furnished as specified herein and as indicated on the drawings. Switchboards shall meet the following requirements, and the design conditions and features..

1-2. GENERAL. Equipment furnished and installed under this section shall be fabricated, assembled, erected, and placed in proper operating condition in full conformity with the drawings, specifications, engineering data, instructions, and recommendations of the equipment manufacturer.

1-2.01. General Equipment Stipulations. The General Equipment Stipulations shall apply to all equipment furnished under this section. If requirements in this specification differ from those in the General Equipment Stipulations, the requirements specified herein shall take precedence.

1-2.02. Dimensional Restrictions. Layout dimensions will vary between manufacturers, and the layout area indicated on the drawings is based on typical values. The supplier shall review the contract drawings, the manufacturer's layout drawings and installation requirements, and make any modifications required for proper installation subject to acceptance by Engineer.

1-2.03. Workmanship and Materials. Equipment supplier shall guarantee all equipment against faulty or inadequate design, improper assembly or erection, defective workmanship or materials, and leakage, breakage, or other failure. Materials shall be suitable for service conditions.

All equipment shall be designed, fabricated, and assembled in accordance with applicable governing standards. Individual parts shall be manufactured to standard sizes and thicknesses so that repair parts, furnished at any time, can be installed in the field. Like parts of duplicate units shall be interchangeable. Equipment shall not have been in service at any time prior to delivery, except as required by tests.

1-2.04. Governing Standards. All equipment furnished under this section shall be designed, constructed, and tested in accordance with all the applicable standards of ANSI, NEMA, and UL, including, but not limited to, NEMA PB 2 and UL 891 (switchboards); NEMA AB1 and UL 489 (molded-case circuit breakers); ICS-6 (enclosures); and NEMA PD 2.2 (Ground Fault Protection).

Equipment covered by this section shall be listed by UL or a nationally recognized third-party testing laboratory. All costs associated with obtaining the listing shall be the responsibility of Contractor. In the event no third-party testing laboratory provides the required listing, an independent test shall be conducted at Contractor's expense. Before the test is conducted, Contractor shall submit a copy of the testing procedure to Engineer.

1-2.05. Nameplates. Each switchboard section shall have a nameplate permanently affixed to it, listing the following information:

Name of manufacturer
System voltage
Main bus ratings
Type
Manufacturer's shop order number and date

In addition, each circuit breaker and instrument on the front of the switchboard shall have a suitable nameplate. Each incoming line section shall be furnished with a nameplate to indicate the power source or substation from which it is fed. The nameplates for the distribution circuit breakers shall indicate the equipment fed through the breaker. Nameplates shall be black and white laminated phenolic material of suitable size, and shall be engraved with 3/4 inch [19 mm] high letters for section and circuit breaker identity and 1/8 inch [3 mm] letters for other information. The engraving shall extend through the black exterior lamination to the white center.

Each control device and each control wire terminal block connection inside the units shall be identified with a permanent nameplate or painted legend to match the identification on the manufacturer's wiring diagram.

1-2.06. System Characteristics. The switchboard will be connected to a power system with characteristics as specified below.

Voltage rating	480Y/277 V
Frequency	60 Hz
Type	Three phase and neutral

1-3. SUBMITTALS. Complete assembly, foundation, and installation drawings, together with complete engineering data covering the materials used, parts, devices, and accessories forming a part of the switchboard, shall be submitted in accordance with the submittals section. The drawings and data shall include, but shall not be limited to, the following:

Switchboard

Elevation, plan, conduit entrance locations, and weight.

Circuit breaker time-current characteristic curves.

Nameplate legends and equipment schedule.

Single-line and control wiring interconnection diagrams.

Metering section details.

Shop test report.

Installation report.

Surge Protection Device (SPD) submittals shall include drawings (including unit dimensions, weights, component and connection locations, mounting provisions, and wiring diagrams), equipment manuals that detail the installation, operation and maintenance instructions for the specified unit(s), and manufacturer's descriptive bulletins and product sheets.

1-4. OPERATION AND MAINTENANCE DATA AND MANUALS. Not used.

1-5. SPARE PARTS. Not used.

1-6. COORDINATION STUDY. A coordination study of the power distribution system will be conducted as specified in the Electrical section. The equipment manufacturer shall provide the following information to Engineer with the initial equipment drawing submittal:

Protective relay coordination curves for each solid-state trip device.

Time current curves shall be provided for the following circuit breakers:

- Main breaker
- Largest feeder breaker
- Smallest breaker

Data for all devices with adjustable settings shall be submitted, with all literature necessary to determine the appropriate settings. This shall include, but shall not be limited to, Operation Manuals for each type of adjustable trip device.

1-7. DELIVERY, STORAGE, AND HANDLING. Shipping shall be in accordance with the Shipping section. Handling and storage shall be in accordance with the Handling and Storage section.

Switchboards shall be equipped to be handled by a crane. Where cranes are not available, switchboards shall be suitable for skidding in place on rollers using jacks to raise and lower the groups.

PART 2 - PRODUCTS

2-1. ACCEPTABLE MANUFACTURERS. Switchboards shall be manufactured by Eaton Cutler-Hammer or Square-D without exception.

2-2. CONSTRUCTION. All equipment furnished under this section shall be front connected, and shall be designed and constructed in accordance with the following requirements and as indicated on the drawings.

2-2.01. Enclosure. The switchboard shall be of deadfront, modular type construction with the required number of vertical sections bolted together to form one rigid, NEMA Type 1 metal-enclosed unit. All sections shall be aligned in both front and rear. The switchboard frame shall be of formed UL gauge steel, rigidly bolted together to support all cover plates, buses, and circuit breakers. Steel base channels shall be bolted to the frame. Each section shall have a removable top plate and an open bottom for installation and termination of conduit. All front covers shall be removable with a single tool and all doors shall be hinged, with removable hinge pins. Enclosures shall have front access, and shall be designed to be installed against a wall.

All outdoor type switchboards shall be provided with weathertight gasketing on all exterior doors, removable covers, and panels.

Adequate bracing shall be provided for seismic forces. The bracing shall be designed for seismic zone 4

2-2.02. Busing. The main a bus shall be tin-plated copper and shall be of sufficient size to limit the temperature rise to 65°C, based on UL tests. End sections shall be predrilled for units to be added in the future. The bus rating shall be as indicated on the drawings.

2-2.02.01. Neutral Bus. A tin-plated copper neutral bus shall be provided through all vertical sections and shall be rated full capacity.

2-2.02.02. Neutral Pad. Not used.

2-2.03. Ground Bus. The ground bus shall extend the entire length of the switchboard and shall be firmly secured to each vertical section. A ground lug shall be provided at each end of the ground bus for connection to building grounding system with 4/0 AWG bare copper cables. Other ground lugs for feeder circuits shall also be supplied as indicated on the drawings.

2-2.04. Incoming Line Sections. Incoming line sections shall be provided as shown on the one-line diagram.

2-2.04.01. Cable Pull Box. Not used.

2-2.04.02. Busway Entry Compartment. Not used.

2-2.04.03. Power Utility Metering Compartment. Not used.

2-2.04.04. Incoming Line Metering Compartment. Not used.

2-2.04.05. Surge Protection Devices.

2-2.04.05.01. Scope. Surge Protection Devices (SPD) shall be provided as specified in section 16050 for each Switchboard.

2-2.04.06. Main Breaker. Not used.

2-2.05. Tie Breaker Section. Not used.

2-2.06. Distribution Section. The distribution section shall be provided to house branch circuit breakers as indicated on the drawings. Circuit breakers shall be molded case type, with a manually operated stored energy mechanism. Molded case circuit breakers shall have solid state electronic trip mechanisms, and shall have ground fault protection.

Circuit breakers shall be removable from the front without disturbing adjacent units. The switchboard shall contain space for future units as indicated on the drawings.

2-2.07. Molded Case Circuit Breakers. Molded case circuit breakers shall be panel mounted. Circuit breakers shall be rated to interrupt and withstand an available fault current of 42,000 A at the system line voltage. Circuit breakers shall be operated by a toggle-type handle and shall

have a quick-make, quick-break, over-center switching mechanism that is mechanically tripfree. Circuit breakers shall have trip units as specified herein. Electronic trip units shall be complete with built-in current transformers. The ampere rating of the trip unit shall be as indicated on the drawings.

The trip unit shall have adjustable settings for continuous amperes, instantaneous pickup, and short-time pickup. Where specified herein, the trip unit shall be provided with additional short delay trip time adjustment for better system coordination. Circuit breakers indicated to be rated less than 100 amperes shall be thermal-magnetic types.

Where specified herein, built-in ground fault protection shall be provided having adjustable pick-up ratings not exceeding 1,200 amperes, time delay adjustable from 0.1 to 0.5 seconds, and a neutral ground fault current transformer.

Solid-state electronic trip breakers shall have built-in test points for testing long delay, instantaneous, and ground fault functions of the breaker by means of a 120 volt ac operated test kit.

2-2.08. Insulated Case Power Circuit Breakers. Not Used.

2-2.09. Shop Painting. All iron and steel surfaces, except machined surfaces and stainless steel, shall be shop painted with the manufacturer's standard coating. Finish color shall be ANSI 61. Field painting, other than touchup painting, will not be required. A sufficient quantity of additional coating material and thinner shall be furnished for field touch up of damaged coatings.

2-3. SHOP TESTS. After the equipment has been completely assembled, it shall be shop tested for general operating conditions, circuit continuity, and high potential and other standard tests for the particular class of equipment as defined by industry standards. Four certified copies of the test results shall be submitted to Engineer before the equipment is shipped.

PART 3 - EXECUTION

3-1. INSTALLATION. Installation will be in accordance with the Electrical Equipment Installation section.

3-2. FIELD QUALITY CONTROL.

3-2.01. Installation Check. An installation check by an authorize representative of the manufacturer is not required.

3-2.02. Installation Supervision. Installation supervision by the manufacturer is not required.

End of Section

This page was left blank intentionally

AUTOMATIC TRANSFER SWITCH

PART 1 - GENERAL

1-1. SCOPE. This section covers both indoor and outdoor automatic transfer switches, which shall be furnished, and tested as specified and as indicated on the drawings. Automatic transfer switch equipment shall meet the design conditions and features.

1-2. GENERAL. Equipment furnished and installed under this section shall be fabricated, assembled, erected, and placed in proper operating condition in full conformity with the drawings, specifications, engineering data, instructions, and recommendations of the equipment manufacturer, unless exceptions are noted by Engineer.

1-2.01. General Equipment Stipulations. The General Equipment Stipulations shall apply to all equipment furnished under this section. If stipulations in this specification differ from those in the General Equipment Stipulations, the requirements specified herein shall take precedence.

1-2.02. Dimensional Restrictions. Layout dimensions will vary between manufacturers and the layout area indicated on the drawings is based on typical values. Contractor shall review the contract drawings, the manufacturer's layout drawings and installation requirements, and make any modifications required for proper installation subject to acceptance by Engineer.

1-2.03. Workmanship and Materials. Equipment supplier shall guarantee all equipment against faulty or inadequate design, improper assembly or erection, defective workmanship or materials, and leakage, breakage, or other failure. Materials shall be suitable for service conditions.

1-2.04. Governing Standards. The equipment furnished under this section shall be designed, constructed, and tested in accordance with UL 1008, Standard for Safety Transfer Switch Equipment; NFPA 110, Standard for Emergency and Standby Power Systems; and the latest applicable standards of ANSI, NEMA, and IEEE.

1-2.05. Nameplates. Each control device and each control wire terminal block connection inside the units shall be identified with a permanent nameplate or painted legend to match the identification on the manufacturer's wiring diagram.

1-2.06. System Characteristics. The equipment will be connected to a power system with characteristics as specified below:

Voltage, phase	480, 3-phase
Frequency	60 Hz
Number of conductors	4-wire

1-3. SUBMITTALS. Complete assembly, foundation, and installation drawings, together with complete engineering data covering the materials used, parts, devices, and accessories forming a

part of the transfer switch, shall be submitted in accordance with the submittals section. The drawings and data shall include, but shall not be limited to, the following:

- Drawings showing front and side views, plan, and weight.
- Rating and specifications.
- Circuit breaker time-current characteristic curves, if applicable.
- Single-line, control schematic, and wiring connection diagrams.
- Operation and maintenance and manuals including a list of spare parts.

1-4. OPERATION AND MAINTENANCE MANUALS. Adequate operation and maintenance information shall be supplied as required in the Submittals section. Operation and maintenance manuals shall be submitted in accordance with the Submittals section. The operation and maintenance manuals shall be in addition to any instructions or parts lists packed with or attached to the equipment when delivered.

1-5. DELIVERY, STORAGE, AND HANDLING. Shipping shall be in accordance with the Shipping section. Handling and Storage shall be in accordance with the Handling and Storage section.

PART 2 - PRODUCTS

2-1. ACCEPTABLE MANUFACTURERS. The automatic transfer switch shall be manufactured by Russell Electric or Eaton Cutler-Hammer.

2-2. CONSTRUCTION FEATURES.

2-2.01. Enclosure. The enclosure for the transfer switch shall be as follows:

Type of mounting	Freestanding or wall Mounted
Enclosure rating	Indoor NEMA Type 1 or Outdoor NEMA Type 3R or 4X stainless steel for pad or Wall mounting, with drip shield and door gasket.

2-2.02. Rating. Automatic transfer switches shall be service entrance rated for continuous duty in both normal and emergency positions. The transfer switch shall be rated as indicated on the drawings.

2-2.03. Space Heaters. A thermostatically controlled space heater, sized to prevent condensation within the enclosure, shall be provided, for outdoor units only. A disconnect switch shall be provided for the heater circuit. The space heater shall be rated for 120 volts ac and will be powered from an internal power source.

2-2.04. Surge Protection Device. Surge protection devices shall be provided for each ATS as indicated on the drawings and as specified in 16050.

2-3. PERFORMANCE AND DESIGN REQUIREMENTS.

2-3.01. Equipment Description. The automatic transfer switch shall transfer electric loads from the normal source of electric power to an emergency source of power as indicated on the drawings. The transfer switch shall automatically transfer the electrical load circuits upon an interruption or a decrease in the voltage of the normal source of power and shall transfer the loads back to the normal source when it becomes available. The transfer switch shall be furnished with integral overcurrent protection as required. The switch shall be electrically operated but mechanically held in both the normal and emergency positions. The operating mechanism shall be momentarily energized from the source to which the load is being transferred. The automatic transfer switch shall be so designed that the load circuits cannot be connected to more than one source of power at a time.

2-3.01.01. Automatic Transfer Switch. .

1. Switches shall be Floor or Wall Mounted construction. There shall be permanently affixed to the interior of the enclosure door both a data-plate that includes generator KVA/KW, fuel tank capacity, rated fuel consumption, serial and model number of generator set, and a 10-inch x 12 inch pocket for log sheet storage.
2. The switching panel shall consist of completely enclosed assemblies and a separate control or transformer panel. Control power for all transfer operations shall be derived from the line side of the source to which the load is being transferred.
3. Each transfer switch shall be positively interlocked both mechanically and electrically to prevent simultaneous closing of both sources under either automatic or manual operation. Main contacts shall be mechanically locked in position in both normal and emergency positions.
4. Transfer switches shall be capable of being operated manually under full rated load conditions. Manual operation shall be accomplished by a permanently attached manual operator, or by integrally mounted pushbuttons. Removable manual operating handles, and handles that may move in the event of an electrical operation during the manual operation, are not acceptable. Manual operators requiring source or load disconnection prior to manual operation are not acceptable.
5. The transfer switch shall have a multi-tap voltage selection plug for ease of voltage adjustment in the field.
6. Where shown on the drawings, transfer switches applied as service entrance equipment, shall be provided with over-current trip units and a service entrance label. A key-operated selector switch shall be provided to disconnect the power supplies. Indicators shall be provided to show the availability of each source as well as breakers in a disconnected position. Provide a neutral disconnect link for four-pole switched neutral switches, and a removable neutral-to-ground main bonding jumper, on utility incoming source only, for switches to meet UL service entrance requirements.
7. Where indicated on the drawings, the transfer switches shall be provided with a draw-out mechanism to allow easy access for preventive maintenance, testing or inspection. The draw-out mechanism shall provide visual indicators as to the position of the switch/breaker during the draw-out operation.

2-3.01.02. Bypass-Isolation Switch. Not Used.

2-3.01.03. Control System. The microprocessor-based logic controller shall be door mounted and shall provide the operator with an overview of the transfer switch status, parameters, and diagnostic data. The controller shall be hardened against potential problems from transients and surges. Operation of the transfer switch and monitoring of both sources shall be managed by the controller. The controller shall have a voltage range of 0-790 volts (50/60 Hz) and an accuracy of +/- 2% of nominal input voltage. The controller shall have a frequency range of 40-80 Hz and an accuracy of +/- .1 Hz. Control power input range shall be from 65 Vac – 160 Vac RMS 50/60 Hz. The controller shall be listed under UL Standard 1008.

The microprocessor-based controller shall include an LED display, and shall display the following:

A detailed step-by-step operating instruction plate shall be provided on the front of the switch.

Connected Source and Load voltages on all phases

Connected Source and Load frequency

Condition status – Under-voltage, under-frequency, etc...

Real time clock for Time / Date stamp

Historical data

Programming and set point information

Password entry

Timer countdown for each timer while functioning

Help function for detailed description of displayed messages

The microprocessor-based controller shall include individual LED's for indicating the following:

Mimic Bus Diagram showing Availability status of NORMAL source

Mimic Bus Diagram showing Availability status of EMERGENCY source

Mimic Bus Diagram showing Connection status of NORMAL source

Mimic Bus Diagram showing Connection status of EMERGENCY source

Mimic Bus Diagram showing Preferred status of NORMAL source

Mimic Bus Diagram showing Preferred status of EMERGENCY source

Mimic Bus Diagram showing Energized status of LOAD

Automatic mode

Test mode

Program mode

Display Navigational indicators for Status, Source 1, Source 2, History, Time/Date and Set Points

The microprocessor-based controller shall contain the following features:

Password programming protection

Set points shall be stored in Non-Volatile memory, and use of an external battery source to maintain operation during “dead” periods shall not be required.

Selector Switch for “PROGRAM” or “RUN”

Historical Data Storage to include:

Engine Run Time

NORMAL source Available time

EMERGENCY source Available time

NORMAL source Connected time

EMERGENCY source Connected time

LOAD Energized Time

Number of Transfers

Date, Time and Reason for Last Sixteen (16) transfers

The microprocessor-based controller shall contain the following voltage and frequency features:
The voltage of each phase of the NORMAL source and the EMERGENCY source shall be monitored, with under-voltage dropout adjustable from 50% to 90% of nominal and pickup adjustable from dropout setting +/-2% to 100% of nominal. The transfer to emergency will be initiated upon reduction of the normal source to 85 percent of the normal voltage, and retransfer to normal shall occur when the normal source restores to 90 percent of the normal voltage.

The frequency of the NORMAL source and the EMERGENCY source shall be monitored with under-frequency dropout adjustable from 90% to 100% of nominal and pickup adjustable from dropout setting +1 Hz to 110% of nominal.

The microprocessor-based controller shall contain the following time delay features:

A time delay shall be provided on transfer to EMERGENCY source, adjustable from 0 to 1800 seconds. TDNE – Time Delay Normal to Emergency

A time delay shall be provided to override a momentary power outage or voltage fluctuation, adjustable from 0 to 120 seconds. TDES – Time Delay engine Start

A time delay shall be provided on retransfer from EMERGENCY source to NORMAL source, adjustable from 0 to 1800 seconds. The time delay shall be automatically bypassed if the emergency source fails and the normal source is available. TDEN – Time Delay Emergency to Normal

A time delay shall be provided after retransfer that allows the generator to run unloaded prior to shutdown, adjustable form 0 to 1800 seconds. TDEC – Time Delay Engine Cool down

A time delay shall be provided for engine failure to start, fixed setting of 6 seconds. TDEF – Time Delay Engine Fail

An In-Phase Monitor transition, which will permit a transfer or re-transfer between the NORMAL and EMERGENCY sources that have a phase angle difference of 8 degrees or less. Feature to include a permissible frequency difference and synchronization time set points of 1-60 minutes. The adjustable frequency difference shall be 0.00 to 3.0 Hz

All delays shall be field adjustable from the microprocessor-based controller without the use of special tools.

The microprocessor-based controller shall contain the following features:

“HELP”, “INCREASE”, “DECREASE”, “STEP” and “DISPLAY SELECT” pushbuttons
Plant exerciser, selectable – 7-day interval, adjustable 0-600 minutes, load or no-load with Failsafe

System Test Pushbutton

Maintained 4-Position Test Switch “AUTO”, “TEST”, ENGINE START” and “OFF”

Bypass Time Delay Emergency to Normal (TDEN) Pushbutton

Bypass Time Delay Normal to Emergency (TDNE) Pushbutton

Maintenance Electrical Operator Isolator Switch. Provide a 2-Position Selector Switch, maintained contact, marked: “OPERATE” and “DISABLE”.

Lockable stainless steel cover for controller

The microprocessor-based controller shall contain the following input/output contacts:

One (1) Form A contact for closure of the Generator start circuit. The contacts shall be of silver alloy with gold flashing. The contacts shall be rated for 5-Amp at 250-Vac and 5-Amp at 30-Vdc.

One (1) Form C contact for NORMAL Source Position. The contacts shall be rated for 10-Amp at 250-Vac and 10-Amp at 30-Vdc. {15E}

One (1) Form C contact for EMERGENCY Source Position. The contacts shall be rated for 10-Amp at 250-Vac and 10-Amp at 30-Vdc. {15F}

One (1) Form C contact for NORMAL Source Available. The contacts shall be rated for 10-Amp at 250-Vac and 10-Amp at 30-Vdc. {14E}

One (1) Form C contact for EMERGENCY Source Available. The contacts shall be rated for 10-Amp at 250-Vac and 10-Amp at 30-Vdc. {14F}

One (1) Form C contact for ALARM SIGNAL. The contacts shall be rated for 10-Amp at 250-Vac and 10-Amp at 30-Vdc.

The control system shall consist of all control devices necessary to operate the switch as described.

All control components shall meet or exceed the voltage withstand capability in accordance with IEEE 472 and NEMA ICS 1-109.

2-3.03. Shop Painting. All iron and steel surfaces, except machined surfaces and stainless steel, shall be shop painted with the manufacturer's standard coating. Finish color shall be ANSI 61. Field painting, other than touchup painting, shall not be required. A sufficient quantity of additional coating material and thinner shall be furnished to permit field touchup of damaged coatings.

The underside of equipment to be installed in exposed outdoor locations shall be thoroughly cleaned and coated with an automotive type undercoating material. The coating shall be thick enough to withstand normal handling during shipping and installation. The underside is defined as the surfaces in contact with the floor or pad and other surfaces not readily accessible for field painting. The coating may be factory or field applied.

2-3.04. Shop Tests. After the equipment has been completely assembled, it shall be shop tested for general operating condition, circuit continuity, high potential, and for compliance with the governing standards. Certified test results shall be submitted to Engineer before the equipment is shipped.

PART 3 - EXECUTION

3-1. INSTALLATION. The transfer switch will be installed in accordance with Section 16100 and manufacturers instructions.

3-2. FIELD QUALITY CONTROL.

3-2.01. Installation Check. An installation check by a representative of the manufacturer is not required.

End of Section

This page was left blank intentionally

LIGHTNING PROTECTION SYSTEMS

PART 1 - GENERAL

1.1 SCOPE. This section covers furnishing the design of the lightning protection systems for the site and the furnishing and installation of the lightning protection equipment.

Lightning protection systems shall be furnished, installed, and tested as specified. Lightning protection equipment shall meet the requirements specified herein.

Lightning protection systems shall consist of, but not be limited to, air terminals; main, bonding, and down conductors; ground terminals; and all required connectors and fittings required to complete the system.

The lightning protection system shall include the bonding of all roof-mounted mechanical equipment, roof drains, roof mounted ladders, chimneys, antennas, and other roof mounted metal objects.

1-2. GENERAL. Contractor shall furnish all installation drawings, tools, equipment, materials, and supplies and shall perform all labor and obtain all inspections to complete the work as specified, and in compliance with all codes, standards, and regulations.

Contractor shall provide coordination with other contractors and supervision of installation as needed during construction.

The design of the system shall include determination of the overall lightning hazard for the geographic location of the project and for the structures, the selection of Class I and/or Class II materials, the need of corrosion protection for the copper and/or aluminum components used, and consideration of other pertinent factors. The design shall produce a zone of protection from lightning to prevent personal injury, structural damage, and equipment downtime.

Equipment furnished and installed under this section shall be fabricated, assembled, erected, and placed in proper operating condition in full conformity with the drawings, specifications, engineering data, instructions, and recommendations of UL unless exceptions are noted by Engineer.

The system shall be installed by an installer who has UL listing and subscribes to the UL Follow-Up Service.

1-2.01. General Equipment Stipulations. The General Equipment Stipulations shall apply to all equipment furnished under this section.

Lightning protection systems shall be bonded to grounding electrode systems in accordance with the National Electrical Code. If requirements in this specification differ from those in the General Equipment Stipulations, the requirements specified herein shall take precedence.

1-2.02. Governing Standards. All system components furnished under this section shall be designed in accordance with ANSI/UL 96 - Lightning Protection Components. All lightning protection systems furnished under this section shall be designed, constructed, and tested in accordance with UL 96A – Installation Requirements for Lightning Protection Systems and ANSI/NFPA 780 – Standard for the Installation of Lightning Protection Systems.

Lightning protection systems shall be bonded to grounding electrode systems in accordance with the National Electrical Code.

1-2.03. Workmanship and Materials. Contractor shall guarantee all equipment against faulty or inadequate design, improper assembly or erection, defective workmanship or materials, and leakage, breakage, or other failure. Materials shall be suitable for service conditions.

All equipment shall be designed, fabricated, and assembled in accordance with recognized and acceptable engineering and shop practice. Individual parts shall be manufactured to standard sizes and thicknesses so that repair parts, furnished at any time, can be installed in the field. Like parts of duplicate units shall be interchangeable. Equipment shall not have been in service at any time prior to delivery, unless required by tests.

1-3. SUBMITTALS. Complete certification of design calculations; assembly, and installation drawings; together with complete engineering data covering the materials used and the parts, devices, and accessories forming the system, shall be submitted in accordance with the submittals section.

1-4. QUALITY ASSURANCE. The lightning protection system shall be inspected and tested after installation by conducting continuity and ground resistance tests as well as a visual inspection. Inspection results and test data shall be submitted in accordance with the submittals section. Upon completion of the installation, Contractor shall apply for and deliver the UL Master Label “C” for each structure/building.

PART 2 - PRODUCTS

2-1. ACCEPTABLE MANUFACTURERS. The system components shall be manufactured by a company that has been specializing in the design and manufacture of UL listed lightning protection equipment for at least 5 years.

2-2. MATERIALS. All manufactured and fabricated components shall conform to NFPA 780 Class I or Class II as needed for the structures on which they will be installed. Aluminum conductors and air terminals shall be mounted on aluminum surfaces only.

All materials furnished for the lightning protection system shall bear the inspection label of UL.

PART 3 - EXECUTION

3-1. INSTALLATION. The lightning protection system shall be installed in a neat and inconspicuous manner so all components will blend in with the appearance of the building. All conductors shall be concealed or semi-concealed during construction using methods recommended in NFPA 780 and UL 96A.

Air terminals shall have base supports designed for the surface on which they are used and shall be securely anchored. All exposed metal eave troughs, roof vents, guy wires, antennas, and air handling equipment shall be bonded to the lightning protection system in such a way that two paths to ground are provided.

The lightning protection system shall be bonded to structure/building electrical ground rings wherever they are available.

End of Section

This page was left blank intentionally